Digital Multimeters

Truevolt Series

This manual contains information for using, programming, and servicing the Keysight Truevolt Series Digital Multimeters (DMMs).

Notice: This document contains references to Agilent Technologies. Agilent's former Test and Measurement business has become Keysight Technologies. For more information, go to www.keysight.com.



Safety and Regulatory Information	11
Notices	11
Manual Information	11
Software Revision	11
Warranty	11
Technology Licenses	11
Restricted Rights Legend	12
Safety Notices	13
Safety Symbols	13
Safety Information	14
General	14
Product Regulatory and Compliance	16
Measurement Limits	16
Input Terminal Measurement Limits	18
Sense Terminal Measurement Limits	18
IEC Measurement Category II	19
Keysight 34139A Test Lead Set	19
Test Lead Ratings	19
Operation	19
Maintenance	19
Declaration of Conformity	20
Welcome	21
Introductory Information	21
User Information	21
SCPI Programming Reference	22
Service and Repair	22
Performance Verification	22
Calibration Procedures	22
Introduction to the Instrument	23
Instrument at a Glance	23
Display – Easily display, save and document your measurement results	23
Measurements – Keysight’s Truevolt measurement performance with modern I/O accessibility	23
Programming Language	23
Front Panel at a Glance	24
Front Panel Keys	24
Rear Panel at a Glance	25
Models and Options	26
Options Installed at Factory	26
Options Installed by Distributor or End Customer	26
Remote Interface Configuration	27
Connectivity Software	27
GPIB Configuration	27
LAN Configuration	28
Web Interface	31
LAN Configuration Procedure	32
More about IP Addresses and Dot Notation	33
Firmware Update	34
Contacting Keysight Technologies	35
Quick Start	36
Prepare Instrument for Use	36
Setting the AC Mains Line Voltage Selector and Fuse Installation	37

Connect Power and I/O Cables	39
Adjust the Carrying Handle	40
Use Built-in Help System	41
View the help information for a front panel key	41
View the list of help topics and use interactive demos	42
View the list of recent instrument errors.	43
View the help information for displayed messages.	43
Rack Mount the Instrument	44
Removing the Handle and Bumpers	44
Rack Mounting a Single Instrument	44
Removing the Front Panel Side Screws and Washers	45
Rack Mounting Instruments Side-by-Side	45
Sliding Support Shelf	45
Features and Functions	46
Continuous, Data Log, and Digitize Modes	47
Continuous Mode	47
Data Log Mode	47
Digitize Mode	47
Data Log and Digitize Mode Default Settings	48
Additional Data Log Default Settings	48
Additional Digitize Default Settings	49
Front Panel Menu Reference	50
[Acquire] key	54
[Math] key	54
[Display] key	54
[Utility] key	55
Measurements	56
DC Voltage	57
AC Voltage	60
DC Current	62
AC Current	64
Resistance	66
Temperature (34460A and 34461A)	69
Temperature (34465A and 34470A)	71
Capacitance	76
Continuity	77
Diode	78
Frequency and Period	79
Data Logging	81
Digitizing	86
Level Triggering	91
Secondary Measurements	93
Triggering and Readings	95
Instrument trigger model	95
Trigger delay and multiple samples	97
Storing and clearing readings	98
Probe Hold	100
Math - Introduction	101
Math - Null	102
Math - dB/dBm Scaling	103
Math - Scaling	105
Math - Smoothing	108

Math - Statistics	109
Math - Limits	110
Display - Introduction	114
Selecting the Display	114
Number	116
Bar Meter	121
Trend Chart (Continuous Measurement Mode)	124
Trend Chart (Digitize and Data Log Modes)	127
Histogram	133
Utility Menu - Introduction	138
Utility - Autocalibration (34465A/70A only)	139
Utility - Store and Recall State and Preference Files	140
Utility Menu - Manage Files	142
Utility Menu - I/O Configuration	144
Utility Menu - Test/Admin	147
Utility Menu - System Setup	149
Web Interface	152
Welcome Page	152
Instrument Monitor and Control Page	153
Configuration Page	157
Help	158
Measurement Tutorial	159
Measurement Considerations	160
Metrology	161
DC Measurement Considerations	162
Thermal EMF Errors	162
Loading Errors (DC Voltage)	162
Noise Rejection	163
Rejecting Power-Line Noise Voltages	163
Common Mode Rejection (CMR)	163
Noise Caused by Magnetic Loops	163
Noise Caused by Ground Loops	164
Resistance Measurement Considerations	165
Removing Test Lead Resistance Errors	165
Minimizing Power Dissipation Effects	166
Errors in High Resistance Measurements	166
True RMS AC Measurements	167
True RMS Accuracy and High-Frequency Signal Content	168
Estimating High-Frequency (Out-of-Band) Error	169
Other Primary Measurement Functions	171
Frequency and Period Measurement Errors	171
DC Current	171
Temperature Measurements	172
NULL Reading	173
Autozero On/Off	173
Making High-Speed AC Measurements	173
Making High-Speed DC and Resistance Measurements	174
Capacitance	175
Capacitance Measurement Considerations	176
Digitizing Measurements	177
The Sampling Rate	177
Level Triggering	178

About Digitize Mode	178
Data Log and Digitizing Local Remote Interaction	180
Data Log Mode	181
Data Log Mode Features	181
Data Logging and the Trend Chart Display	185
Data Log and Digitizing Local Remote Interaction	186
Level Triggering	187
About Level Trigger	187
Other Sources of Measurement Error	189
Settling Time Effects	189
Loading Errors (AC volts)	189
Measurements Below Full Scale	190
High-Voltage Self-Heating Errors	190
AC Current Measurement Errors (Burden Voltage)	190
Low-Level Measurement Errors	191
Common Mode Errors	191
Leakage Current Errors	192
Unnecessary Signal Errors	192
How Sample Rate/Interval is Determined	193
SCPI Programming Reference	194
Related Information	194
IO Libraries and Instrument Drivers	194
Keysight Truevolt Series Documentation	194
Web Interface	194
Introduction to the SCPI Language	195
Syntax Conventions	195
Command Separators	196
Using the MIN, MAX and DEF Parameters	196
Querying Parameter Settings	196
SCPI Command Terminators	197
IEEE-488.2 Common Commands	197
SCPI Parameter Types	197
Using Device Clear	199
Commands by Subsystem	199
ABORT	201
FETCh?	202
INITiate[:IMMediate]	203
OUTPut:TRIGger:SLOPe {POSitive NEGative}OUTPut:TRIGger:SLOPe?	204
R? [<max_readings>]	205
READ?	206
ROUTE:TERMinals?	207
TEST:ALL?	208
UNIT:TEMPerature {C F K}UNIT:TEMPerature?	209
CALCulate Subsystem Introduction	210
CALibration Subsystem	237
CONFigure Subsystem	243
DATA Subsystem	256
DISPlay Subsystem	259
FORMat Subsystem	261
HCOPy Subsystem	263
IEEE 488.2 Common Commands	264
LXI Subsystem	277

MEASure Subsystem	280
MMEMory Subsystem - General Purpose File Management	291
MMEMory Subsystem - STATe and PREFerece Files	296
MMEMory Subsystem - Data Transfer Commands	301
SAMPlE Subsystem	306
SENSe Subsystem Introduction	313
STATus Subsystem	387
SYSTem Subsystem - General Purpose Commands	393
SYSTem Subsystem - I/O Configuration	406
SYSTem Subsystem LOCK Commands	420
SYSTem Subsystem LICense Commands	423
TRIGger Subsystem	428
Command Quick Reference	436
Configuration Commands	436
Measurement Commands	436
Measurement Configuration Commands	436
Sample Commands	443
Triggering Commands	443
Calculation (Math) Commands	444
Reading Memory Commands	446
Calibration Commands	447
State Storage and Preferences Commands	447
General Purpose File Management Commands	448
Data Transfer Commands	449
IEEE-488 Commands	449
Format Subsystem	450
System-Related Commands	450
Interface Locking Commands	451
License Management Commands	452
Interface Configuration Commands	452
Status System Commands	453
Range, Resolution and Integration Time (shown in Aperture and NPLCs)	454
Resolution and Integration Time for DC Measurements	457
Automatic Trigger Delays	458
DC Voltage Default Delays	458
DC Current Default Delays	458
Resistance (2-wire) Default Delays	459
Resistance (4-wire) Default Delays	459
AC Voltage Default Delays	459
AC Current Default Delays	460
Frequency and Period	460
VM Comp Output (BNC)	461
SCPI Error Messages	462
Command Errors (-100...)	464
Execution Errors (-200...)	466
Device-Specific Errors (-300...)	469
Query Errors (-400...)	469
Network Errors (+100...)	469
Instrument Errors (+200...)	470
Miscellaneous Errors (+300... and +500..)	470
Licensing and Self-test Errors (+600...)	471
Calibration Errors (+700...)	473
Miscellaneous Errors (+800...)	475

Power-On and Reset State	476
Factory Default Settings	476
Service and Repair	479
Types of Service Available	479
Obtaining Repair Service (Worldwide)	479
Repackaging for Shipment	480
Cleaning	480
Electrostatic Discharge (ESD) Precautions	480
Power Supplies	481
Troubleshooting	484
Troubleshooting Procedure	485
Self-Test Procedures	488
Power-On Self-Test	488
Full Self-Test	488
User Replaceable Parts	489
Disassembly	490
Tools Required	490
General Disassembly Procedure	491
Battery Replacement	494
Tools Required	494
Procedure	495
3 A and 10 A Current Path Fuse Replacement	496
Tools Required	496
Testing the Fuses	497
Internal Fuse Replacement Procedure	498
Installing the Optional GPIB Interface	499
Tools Required	499
Installation Procedure	499
Retain GPIB Cover Plate	499
Security Code Override	501
Which Procedure Should I Use?	501
Procedure A: For Firmware Revision Ending in 02, or Greater	502
Procedure B: For Firmware Revision Ending in 01	504
Performance Verification	505
Quick Performance Check	506
Performance Verification Tests	507
Recommended Test Equipment	507
Zero Offset Verification	508
DC Volts and DC Current Gain Verification	512
Frequency Accuracy Verification	517
AC Voltage and AC Current Verification	518
High Current Verification	523
Capacitance Verification (Optional Verification Test)	524
Calibration Adjustment Procedures	525
Calibration Procedures	526
Input Connections	527
Test Considerations	527
Recommended Test Equipment	528
Calibration Adjustment Process	529
Gain Calibration Adjustment Overview	530
Gain and Flatness Calibration Adjustment Overview	531

Entering Calibration Values and Storing Calibration Constants	532
Calibration Security	533
Calibration Message	534
Calibration Count	535
Aborting a Calibration in Progress	536
Security Code Override	537
34460A and 34461A Calibration Procedures	542
ADC and Zero Calibration	543
AC Voltage Low Frequency Gain and Flatness Calibration	545
AC Voltage Gain and Flatness Calibration	546
AC Current Gain and Flatness Calibration	547
AC Zero Calibration	548
Frequency Accuracy Calibration	549
DC Voltage Gain Calibration	550
Ohms Gain Calibration	551
DC Current Gain Calibration	552
AC Current 10 A Gain Calibration	553
DC Current 10 A Gain Calibration	554
Capacitance Offset Calibration (Optional)	555
Finishing Calibration	556
34465A and 34470A Calibration Procedures	557
ADC and Zero Calibration	558
AC Voltage Low Frequency Gain and Flatness Calibration	560
AC Voltage Gain and Flatness Calibration	561
AC Current Gain and Flatness Calibration	562
AC Zero Calibration	563
Frequency Accuracy Calibration	564
DC Voltage Gain Calibration	565
Ohms Gain Calibration	566
DC Current Gain Calibration	567
DC High Voltage Gain Calibration	568
AC Current 10 A Gain Calibration	569
DC Current 10 A Gain Calibration	570
Capacitance Offset Calibration (Optional)	571
Finishing Calibration	572
Index	573

Safety and Regulatory Information

Notices

© Keysight Technologies 2013 - 2023

No part of this manual may be reproduced in any form or by any means (including electronic storage and retrieval or translation into a foreign language) without prior agreement and written consent from Keysight Technologies, Inc. as governed by United States and international copyright laws.

Manual Information

Part Number: 34460-90901, Edition 10, September 2023

Keysight Technologies, Inc
900 S. Taft Ave.
Loveland, CO 80537 USA

Software Revision

For the latest firmware, go to the product page at www.keysight.com/find/truevolt.

The latest product documentation is available at www.keysight.com/find/truevolt-doc. For documentation for mobile devices, see www.keysight.com/find/truevolt-mobilehelp.

A portion of the software in this product is licensed under terms of the General Public License Version 2 ("GPLv2"). The text of the license and source code can be found at www.keysight.com/find/GPLV2.

This product uses Microsoft Windows CE. Keysight highly recommends that all Windows-based computers connected to Windows CE instruments use current anti-virus software. For more information, see www.keysight.com/find/truevolt.

Warranty

The material contained in this document is provided "as is," and is subject to being changed, without notice, in future editions. Further, to the maximum extent permitted by applicable law, Keysight disclaims all warranties, either express or implied, with regard to this manual and any information contained herein, including but not limited to the implied warranties of merchantability and fitness for a particular purpose. Keysight shall not be liable for errors or for incidental or consequential damages in connection with the furnishing, use, or performance of this document or of any information contained herein. Should Keysight and the user have a separate written agreement with warranty terms covering the material in this document that conflict with these terms, the warranty terms in the separate agreement shall control.

Technology Licenses

The hardware and/or software described in this document are furnished under a license and may be used or copied only in accordance with the terms of such license.

Restricted Rights Legend

U.S. Government Restricted Rights. Software and technical data rights granted to the federal government include only those rights customarily provided to end user customers. Keysight provides this customary commercial license in Software and technical data pursuant to FAR 12.211 (Technical Data) and 12.212 (Computer Software) and, for the Department of Defense, DFARS 252.227-7015 (Technical Data – Commercial Items) and DFARS 227.7202-3 (Rights in Commercial Computer Software or Computer Software Documentation).

Safety Notices

CAUTION

A CAUTION notice denotes a hazard. It calls attention to an operating procedure, practice, or the like that, if not correctly performed or adhered to, could result in damage to the product or loss of important data. Do not proceed beyond a CAUTION notice until the indicated conditions are fully understood and met.

WARNING

A WARNING notice denotes a hazard. It calls attention to an operating procedure, practice, or the like that, if not correctly performed or adhered to, could result in personal injury or death. Do not proceed beyond a WARNING notice until the indicated conditions are fully understood and met.

Safety Symbols



Alternating current



Frame or chassis terminal



Standby supply. Unit is not completely disconnected from AC mains power when switch is off.



WARNING Risk of electric shock



CAUTION Refer to accompanying documents



The CE mark is a registered trademark of the European Community.



The CSA mark with the 'c' and 'us' subscript indicates the instrument is certified to the applicable Canadian and United States of America standards respectively.

**CAT II
(300V)**

IEC Measurement Category II. Inputs may be connected to AC mains power (up to 300 VAC) under Category II overvoltage conditions.



This product is marked with the ACMA RCM mark for compliance in Australia / New Zealand. A copy of the Manufacturer's Australia Declaration of Conformity for this instrument can be obtained by contacting your local Keysight Technologies Sales Representative.

ISM 1-A

This text indicates that the instrument is an Industrial Scientific and Medical Group 1 Class A product (CISPR 11, Clause 4).

ICES/NMB-001

This ISM device complies with Canadian ICES-001.

Cet appareil ISM est conforme à la norme NMB-001 du Canada.

Safety and Regulatory Information



This product complies with the WEEE Directive (2002/96/EC) marking equipment. The affixed product label indicates that you must not discard this electrical/electronic product in domestic household waste.

To return unwanted products, contact your local Keysight office, or see www.keysight.com/environment/product/ for more information.



This equipment is Class A suitable for professional use and is for use in electromagnetic environments outside of the home.

이 기기는 업무용 (A 급) 전자파적합기기로서 판매자 또는 사용자는 이 점을 주의하시기 바라며, 가정외의 지역에서 사용하는 것을 목적으로 합니다.



Contains one or more of the 6 hazardous substances above the maximum concentration value (MCV), 40 Year EPUP.

Safety Information

General

Do not use this product in any manner not specified by the manufacturer. The protective features of this product may be impaired if it is used in a manner not specified in the operation instructions. Do not install substitute parts or perform any unauthorized modification to the product. Return the product to a Keysight Technologies Sales and Service Office for service and repair to ensure that safety features are maintained.

WARNING Product Grounding

The instrument is a Class 1 product and is provided with a grounding-type power cord set. The instrument chassis and cover are connected to the instrument electrical ground to minimize shock hazard. The ground pin of the cord set plug must be firmly connected to the electrical ground (safety ground) terminal at the power outlet. Any interruption of the protective earth (grounding) conductor or disconnection of the protective earth terminal will cause a potential shock hazard that could result in personal injury or death.

WARNING Cleaning

To prevent electrical shock, disconnect the instrument from AC mains power and disconnect all test leads before cleaning. Clean the outside of the instrument using a soft, lint-free, cloth slightly dampened with water. Do not use detergent or solvents. Do not attempt to clean internally. If needed, contact a Keysight Technologies Sales and Service office to arrange for proper cleaning to ensure that safety features and performance are maintained.

WARNING AC Power Cord

Removal of the AC power cord is the disconnect method to remove power from the instrument. Be sure to allow for adequate access to the power cord to permit disconnection from AC power. Use only the Keysight specified power cord for the country of use or one with equivalent ratings.

WARNING Do Not Remove Instrument Cover

Only qualified, service-trained personnel should remove the cover from the instrument. Service: Unplug instrument from wall outlet, remove power cord, and remove all probes from all terminals before servicing.

WARNING AC Mains Power Line Fuse

For continued protection against fire, replace the line fuse only with fuses of the specified type and rating. The instrument must be disconnected from AC mains power, and all measurement terminals must be disconnected before changing the fuse.

WARNING Current Measurement Protection Fuse

For continued protection against fire, replace current-protection fuses only with fuses of the specified type and rating. The instrument must be disconnected from AC mains power, and all measurement terminals must be disconnected before changing the fuse.

WARNING Front/Rear Switch

Do not change the position of the Front/Rear switch on the front panel while signals are present on either the front or rear set of terminals. The switch is not intended as an active multiplexer. Switching while current or high voltage is present may cause instrument damage and lead to the risk of electric shock.

WARNING Do Not Operate in an Explosive Atmosphere or wet environments

Do not operate the instrument around flammable gases or fumes, vapor, or wet environments. The instrument enclosure complies with the IP 20 rating.

WARNING In Case of Damage

An instrument that appears damaged or defective should be made inoperative and secured against unintended operation until qualified service personnel can repair it.

WARNING Self-Test

Before measuring any hazardous voltage or current, remove all test leads to the instrument, run the TEST:ALL? query from the remote interface, and read the result to verify that the instrument is performing properly.

The TEST:ALL? query is a self-test that returns +0 if the instrument passes and +1 if the instrument fails. You can also perform this query from the front panel by pressing [Shift] > [Utility] > Test/Admin > Self Test > Full Test. If this self-test fails, make sure that the instrument is repaired and passes the complete self-test before continuing.

WARNING Measuring AC Power Mains

The HI, LO, and current input terminals may be connected to AC mains power in IEC Category II installations for line voltages up to 300 VAC. To avoid the danger of electric shock, do not connect the inputs to AC mains power for line voltages above 300 VAC. See **IEC Measurement Category II** for further information.

WARNING Measuring Current with A Current Transformer

If a current transformer is used for measuring current, you must use a current transformer with internal secondary protection. Using a current transformer without protection may result in a hazardous voltage resulting in a severe shock or death. In addition, this may cause damage to the instrument.

WARNING Crest Factor

Exceeding the crest factor limit may result in an inaccurate or lower reading display. Do not exceed the crest factor limit to avoid instrument damage and risk of electric shock. The crest factor limit is listed in the product data sheet at www.keysight.com/find/truevolt-doc.

WARNING Measurement Limits

To avoid instrument damage and the risk of electric shock, do not exceed any of the Measurement Limits defined in the following section.

CAUTION This product complies with EN/IEC 61326-2-1, for sensitive test and measurement equipment:

When subjected to transient radiated and/or conducted electromagnetic phenomena, the product may have temporary loss of function or performance which is self-recovering. Recovery may take longer than 10 seconds.

When subjected to continuously present electromagnetic phenomena, some degradation of performance may occur.

CAUTION Unless otherwise noted in the specifications, this instrument or system is intended for indoor use in an installation category II, pollution degree 2 environment per IEC 61010-1 and 664 respectively. It is designed to operate at a maximum relative humidity of 5% to 80% at 40 °C or less (non-condensing). This instrument or system is designed to operate at altitudes up to 3000 meters, and at temperatures between 0 and 55 °C.

CAUTION This instrument is used with mains power of 100 - 240 V, 50/60 Hz or 100 - 120 V, 400 Hz. The maximum power usage is 25 VA. Mains supply voltage fluctuations are not to exceed $\pm 10\%$ of the nominal supply voltage. Ensure you are using the correct mains rated cord based on the instrument's rating and your country's electrical codes.

Product Regulatory and Compliance

The Truevolt Series DMMs comply with safety and EMC requirements.

Refer to Declaration of Conformity at <http://www.keysight.com/go/conformity> for the latest revision.

Measurement Limits

The Truevolt Series DMMs provide protection circuitry to prevent damage to the instrument and to protect against the danger of electric shock, provided the Measurement Limits are not exceeded. To ensure safe operation of the instrument, do not exceed the Measurement Limits shown on the front and rear panel, and defined as follows:

34460A Front Panel Terminal Area

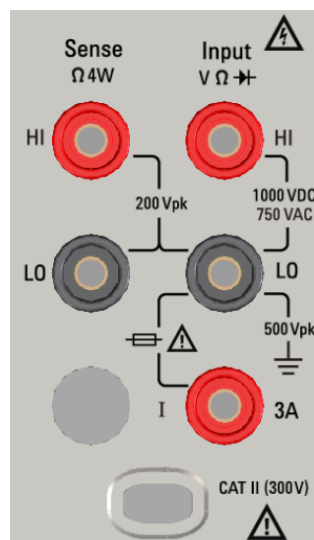

**34461A, 34465A, 34470A
Front Panel
Terminal Area**

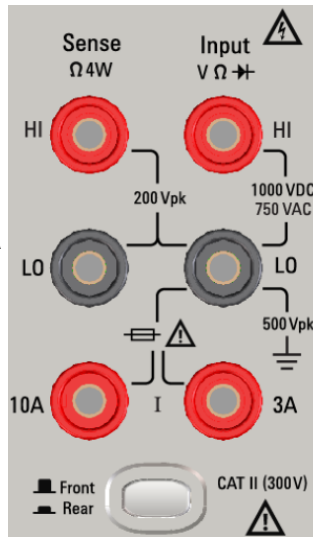

**34461A, 34465A, 34470A
Rear Panel
Terminal Area**

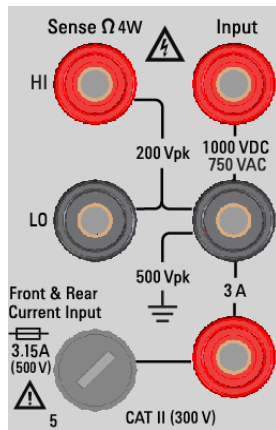

NOTE For the 34461A, 34465A, and 34470A, the Front/Rear switch selects the terminal set to be used. DO NOT operate this switch while signals are present on the front or rear terminals.

The user-replaceable 3 A current-protection fuse is on the rear panel. There are 3 A and 10 A (34461A, 34465A and 34470A) current-protection fuses located inside the unit. Contact your Keysight Sales and Service Center or refer to product service documentation for replacement instructions.

To maintain protection, replace fuses only with **fuses of the specified type and rating**.

Input Terminal Measurement Limits

Measurement Limits are defined for the input terminals:

Main Input (HI and LO) Terminals. The HI and LO input terminals are used for voltage, resistance, frequency (period), capacitance, and diode test measurements. Two Measurement Limits are defined for these terminals:

- **HI to LO Measurement Limit.** The Measurement Limit from HI to LO (Input terminals) is 1000 VDC or 750 VAC, which is also the maximum voltage measurement. This limit can also be expressed as 1000 Vpk maximum.
- **LO to Ground Measurement Limit.** The LO input terminal can safely "float" a maximum of 500 Vpk relative to ground, where ground is defined as the Protective Earth Conductor in the AC mains power cord connected to the instrument.

As implied by the above limits, the Measurement Limit for the HI input terminal is a maximum of 1500 Vpk relative to ground when LO is at its maximum of 500 Vpk relative to ground.

Current Input Terminal. The current input ("I") terminal has a Measurement Limit of 3 A or 10 A (DC or AC) between the "I" terminal (3 A or 10 A) and the LO input terminal. Note that the current input terminals will always be at approximately the same voltage as the LO terminal, unless a current protection fuse is open. The 10 A terminal is not available on the 34460A.

Sense Terminal Measurement Limits

The HI and LO sense terminals are used for DCV ratio measurements and four-wire resistance and temperature measurements. The Measurement Limit is 200 Vpk for all of the terminal pairings: LO sense to LO input, HI sense to LO input, and HI sense to LO sense.

NOTE The 200 Vpk limit on the sense terminals is the Measurement Limit. Operational voltages in resistance measurements are much lower – up to ± 12 V in normal operation.

IEC Measurement Category II

To protect against the danger of electric shock, the Keysight Truevolt Series DMM protects the user from AC mains power overvoltage events. When measuring AC mains, the HI and LO input terminals may be connected to AC mains power up to 300 VAC under Measurement Category II conditions as defined below.

IEC Measurement Category II includes electrical devices connected to AC mains power at an outlet on a branch circuit. Such devices include most small appliances, test equipment, and other devices that plug into a branch outlet or socket. The instrument may be used to make measurements with the HI and LO inputs connected to AC mains power in such devices, or to the branch outlet itself (up to 300 VAC). However, the instrument may not be used with its HI and LO inputs connected to AC mains power in permanently installed electrical devices such as the main circuit-breaker panel, sub-panel disconnect boxes, or permanently wired motors. Such devices and circuits are subject to overvoltages that may exceed the instrument's protection capabilities.

NOTE Voltages above 300 VAC may be measured only in circuits that are isolated from AC mains power. However, transient overvoltages are also present on circuits that are isolated from AC mains power. The instrument is designed to safely withstand occasional transient overvoltages up to 1500 Vpk when measuring voltages greater than 300 VAC. Do not use this equipment to measure circuits where transient overvoltages could exceed this level.

Keysight 34139A Test Lead Set

The Keysight 34139A Test Lead Set, described below, is compatible with the Truevolt Series DMMs.

Test Lead Ratings

- Test Leads - 1000 V, 15 A
- Fine Tip Probe Attachments - 300 V
- 3A Mini Grabber Attachment - 300 V, 3 A
- SMT Grabber Attachments - 300 V, 3 A

Operation

The Fine Tip, Mini Grabber, and SMT Grabber attachments plug onto the probe end of the Test Leads.

Maintenance

If any portion of the Test Lead Set is worn or damaged, do not use. Replace with a new Keysight 34139A Test Lead Set.

WARNING If the Test Lead Set is used in a manner not specified by Keysight Technologies, the protection provided by the Test Lead Set may be impaired. Also, do not use a damaged or worn Test Lead Set. Personal injury or death may result.

Safety and Regulatory Information

Declaration of Conformity

Declarations of Conformity for this product and for other Keysight products may be downloaded from the Keysight Regulatory Web site:

<http://regulations.products.keysight.com/DoC/search.htm>

Welcome

This Operating and Service Guide contains information for using, programming, and servicing the Keysight Truevolt Series Digital Multimeters (DMMs). If you have feedback on this document, please go to www.keysight.com/find/truevolt-docfeedback.

NOTE

In this document, the term "slave" has been replaced with "secondary".

Introductory Information

Safety and Regulatory Information

Models and Options

Quick Start

Contacting Keysight Technologies

Introduction to the Instrument

User Information

Front Panel Menu Reference

Features and Functions

Remote Interface Configuration

LAN Configuration Procedure

Web Interface

Measurements

Triggering and Readings

Probe Hold

Math

Display

Utility Menu

Measurement Tutorial

Welcome

SCPI Programming Reference

Welcome to SCPI

Introduction to the SCPI Language

Commands by Subsystem

Command Quick Reference

Range, Resolution, and NPLC

Resolution Table

VM Comp Output

SCPI Error Messages

Power-On and Reset State

Service and Repair

Service and Repair

Disassembly

Troubleshooting

Power Supplies

Self-Test Procedures

Battery Replacement

Installing the Optional GPIB Interface

User Replaceable Parts

Performance Verification

Performance Verification

Calibration Procedures

Calibration Procedures

34460A and 34461A Calibration Procedures

34465A and 34470A Calibration Procedures

Firmware Update

Introduction to the Instrument

The Keysight Technologies 34460A/61A/65A instruments are 6½-digit digital multimeters (DMMs); the 34470A is a 7½-digit DMM.

[Instrument at a Glance](#)

[Front Panel at a Glance](#)

[Rear Panel at a Glance](#)

[Models and Options](#)

[Contacting Keysight Technologies](#)

Instrument at a Glance

The instrument's combination of bench-top and system features make it a versatile solution now and in the future. The instrument can make a wide range of accurate and flexible measurements.

Display – Easily display, save and document your measurement results

- High usability with an intuitive, menu driven user interface
- Histogram, trend chart (not available on the 34460A), meter, and numeric views on a high-resolution color display
- USB, LAN (optional on 34460A), and optional GPIB interface
- Drag and drop, driverless USB connectivity

Measurements – Keysight's Truevolt measurement performance with modern I/O accessibility

- Patented, metrology-level performance that serves as the foundation for all measurements

Programming Language

- SCPI (Standard Commands for Programmable Instruments) programming language

Front Panel at a Glance



Item	Description
1	USB Port
2	Display
3	Measurement Configuration and Instrument Operation Keys
4	HI and LO Sense Terminals
5	HI and LO Input Terminals
6	AC/DC Current Input Terminals (10 A terminal not available on 34460A)
7	On/Standby Switch
8	Softkeys
9	Cursor Navigation Keypad
10	Range Selection Keys
11	Front/Rear Switch (34461A/65A/70A only)

Front Panel Keys

NOTE

Some of the front panel keys have text above them. This indicates that the key has a function that you can access by pressing and releasing **[Shift]** before pressing the key. For example, if you press and release **[Shift]** before pressing **[Display]**, you will access the **[Utility]** function:



Rear Panel at a Glance

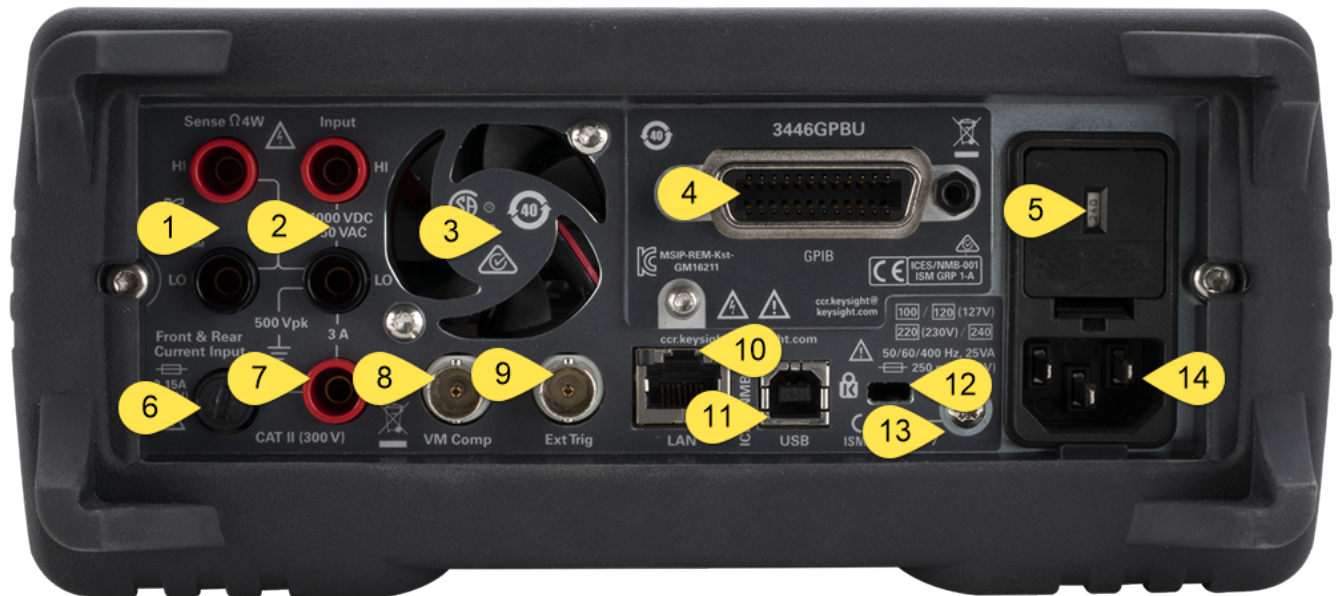

Item	Description
1	HI and LO Sense Terminals (34461A/65A/70A only)
2	HI and LO Input Terminals (34461A/65A/70A only)
3	Fan Vents (34461A/65A/70A only)
4	GPIB Connector (optional)
5	AC Mains Line Voltage Selector and Fuse Access
6	3 A Current Terminal Fuse
7	3 A Current Terminal (34461A/65A/70A only)
8	Voltmeter Measurement Complete Output
9	External Trigger Input
10	Local Area Network (LAN) Connector
11	USB Interface Connector
12	Instrument Cable Lock
13	Chassis Ground Screw
14	AC Mains Input

Models and Options

The available Truevolt Digital Multimeter (DMM) models are:

- 34460A - 6½-digit Basic DMM
- 34461A - 6½-digit 34401A Replacement DMM
- 34465A - 6½-digit DMM
- 34470A - 7½-digit DMM

The factory-installed options and the options that can be installed by you or a distributor are listed in the tables below. You can determine the installed options from the instrument's front panel by pressing **[Shift]** > **[Help]** > **About**.

Options Installed at Factory

34460A	34461A	34465A	34470A	Description
34460A-LAN	*N/A - Standard	*N/A - Standard	*N/A - Standard	Rear panel LAN/LXI web interface, external triggering for 34460A.
34460A-SEC	34461A-SEC	34465A-SEC	34470A-SEC	NISPOM and file security for Truevolt series DMMs license.
34460A-GPB	34461A-GPB	34465A-GPB	34470A-GPB	User-installable GPIB interface module
34460A-ACC	*N/A - Standard	*N/A - Standard	*N/A - Standard	Accessory kit for 34460A - Test Leads, USB Cable
34460A-Z54	34461A-Z54	34465A-Z54	34470A-Z54	Certificate of calibration – ANSI/NCSL Z540.3-2006, printed
*N/A	*N/A	34465A-DIG	34470A-DIG	Digitizing and advanced triggering. Now included with latest firmware update.
*N/A	*N/A	34465A-MEM	34470A-MEM	2 MB memory license

Options Installed by Distributor or End Customer

Product Number	34460A	34461A	34465A	34470A	Description
3446LANU	Option	*N/A - Standard	*N/A - Standard	*N/A - Standard	Enable rear panel LAN/LXI web interface, external triggering for 34460A
3446SECU	Option	Option	Option	Option	NISPOM and file security for Truevolt series DMMs license.
3446GPBU	Option	Option	Option	Option	User-installable GPIB interface module
3446ACCU	Option	*N/A - Standard	*N/A - Standard	*N/A - Standard	Accessory kit for 34460A - Test Leads, USB Cable
3446MEMU	*N/A	*N/A	Option	Option	2 MB memory for 34465A and 34470A Truevolt DMMs license

*N/A = Not Applicable.

Remote Interface Configuration

NOTE

If you have the security option installed on your instrument, the instrument must be unsecured with the security code to perform many of these actions.

The instrument supports remote interface communication over three interfaces: GPIB (optional), USB, and LAN (optional on 34460A). All three are "live" at power up when the instrument ships from the factory.

- **GPIB Interface:** Set the instrument's GPIB address and connect to your PC using a GPIB cable.
- **USB Interface:** Use the rear-panel USB connector to communicate with your PC. For details, see [USB Settings](#).
- **LAN Interface:** By default, DHCP is on, which may enable communication over LAN. The acronym DHCP stands for Dynamic Host Configuration Protocol, a protocol for assigning dynamic IP addresses to networked devices. With dynamic addressing, a device can have a different IP address every time it connects to the network.

Connectivity Software

- The instrument ships with the **Keysight Automation-Ready CD**. This CD contains Keysight IO Libraries Suite software, which must be installed to enable remote-interface operations. The CD auto-starts and provides information on installing the software. Also includes *Keysight Technologies USB/LAN/GPIB Connectivity Guide*, which contains additional information.

GPIB Configuration

Each device on the GPIB (IEEE-488) interface must have a unique whole number address between 0 and 30. The instrument ships with a default address of 10, and the GPIB address is displayed at power-on.

- This setting is non-volatile; it will not be changed by power cycling or ***RST** or **SYSTem:PRESet**.
- Your computer's GPIB interface card address must not conflict with any instrument on the interface bus.
- **Front Panel:** Press **[Utility] > I/O Config > GPIB Settings**. From this menu, you can set the GPIB address and turn GPIB on or off. After making changes, you must cycle power on the instrument for the change to take effect.
- **SCPI:**
SYSTem:COMMunicate:GPIB:ADDRes <address>
SYSTem:COMMunicate:ENABLE {ON|1|OFF|0},GPIB

LAN Configuration

The following sections describe the primary front panel LAN configuration functions, including SCPI commands where applicable. Some LAN configuration functions can be performed only via SCPI. See **SYSTEM Subsystem - I/O Configuration** for all LAN configuration commands, and see **LAN Configuration Procedure** to configure the LAN via the front panel.

NOTE

Some LAN settings require you to cycle instrument power to activate them. The instrument briefly displays a message when this is the case, so watch the screen closely as you change LAN settings.

Resetting the LAN

You can clear the Web Interface password, turn DHCP on, and restart the LAN at any time:

- **Front Panel:**[Utility] > I/O Config > LAN Reset

The message "Performing LAN Reset" is displayed while the LAN is reset.

- **SCPI:** LXI:RESet

DHCP On/Off

DHCP (Dynamic Host Configuration Protocol) can automatically assign a dynamic IP address to a LAN device. This is typically the easiest way to configure the instrument for LAN.

- This setting is non-volatile; it will not be changed by power cycling or ***RST** or **SYSTEM:PRESet**.
- **Front Panel:**[Utility] > I/O Config > LAN Settings > Modify Settings
Then set the first softkey to DHCP to use DHCP to automatically assign an IP address.
- **SCPI:** **SYSTEM:COMMunicate:LAN:DHCP {ON|1|OFF|0}**
- If you change this parameter, you must either press the **Apply Changes** softkey (front panel) or send **SYSTEM:COMMunicate:LAN:UPDate** (remote interface) for the change to take effect.

To manually set an IP address, Subnet Mask, or Default Gateway, turn DHCP off, then change the IP setup as described below.

IP Address

You can enter a static IP address for the instrument as a four-byte integer expressed in dot notation. Each byte is a decimal value, with no leading zeros (for example, 169.254.2.20).

- If DHCP is on, it attempts to assign an IP address to the instrument. If it fails, Auto-IP attempts to assign an IP address to the instrument.
- Contact your LAN administrator to obtain an IP address.
- This setting is non-volatile; it will not be changed by power cycling or ***RST** or **SYSTem:PRESet**.
- **Front Panel:[Utility] > I/O Config > LAN Settings > Modify Settings**
Then set the first softkey to **Manual** and press **IP Address** to enter a new IP address.
- **SCPI: SYSTem:COMMunicate:LAN:IPADdress "<address>"**
- If you change this parameter, you must either press the **Apply Changes** softkey (front panel) or send **SYSTem:COMMunicate:LAN:UPDate** (remote interface) for the change to take effect.

Subnet Mask

Subnetting allows the LAN administrator to subdivide a network to simplify administration and minimize network traffic. The subnet mask indicates the portion of the host address used to indicate the subnet.

- Contact your LAN administrator for details.
- This setting is non-volatile; it will not be changed by power cycling or ***RST** or **SYSTem:PRESet**.
- **Front Panel:[Utility] > I/O Config > LAN Settings > Modify Settings**
Then set the first softkey to **Manual** and press **Subnet Mask** to enter a new subnet mask with the arrow keys (for example: 255.255.0.0).
- **SCPI: SYSTem:COMMunicate:LAN:SMASk "<mask>"**
- If you change this parameter, you must either press the **Apply Changes** softkey (front panel) or send **SYSTem:COMMunicate:LAN:UPDate** (remote interface) for the change to take effect.

Default Gateway

A gateway is a network device that connects networks. The default gateway setting is the IP address of such a device.

- You need not set a gateway address if using DHCP.
- Contact your LAN administrator for details.
- This setting is non-volatile; it will not be changed by power cycling or ***RST** or **SYSTem:PRESet**.
- **Front Panel:[Utility] > I/O Config > LAN Settings > Modify Settings**
Then set the first softkey to **Manual** and press **More** and **Gateway**. Then set the appropriate gateway address using the arrow keys.
- **SCPI: SYSTem:COMMunicate:LAN:GATeway "<address>"**
- If you change this parameter, you must either press the **Apply Changes** softkey (front panel) or send **SYSTem:COMMunicate:LAN:UPDate** (remote interface) for the change to take effect.

Hostname

A hostname is the host portion of the domain name, which is translated into an IP address.

- The instrument receives a unique hostname at the factory, but you may change it. The hostname must be unique on the LAN.
- The name must start with letter; other characters can be an upper or lower case letters, numeric digits, or dashes ("-").
- This setting is non-volatile; it will not be changed by power cycling or ***RST** or **SYSTem:PRESet**.
- **Front Panel:[Utility] > I/O Config > LAN Settings > Modify Settings**
Then press **Host Name** and enter the hostname with the front panel arrow keys.
- **SCPI: SYSTem:COMMunicate:LAN:HOSTname "<name>"**
- If you change this parameter, you must either press the **Apply Changes** softkey (front panel) or send **SYSTem:COMMunicate:LAN:UPDate** (remote interface) for the change to take effect.

Domain Name

A domain name is a registered Internet name that gets translated into an IP address. You cannot set it from the front panel or SCPI.

DNS Server

DNS (Domain Name Service) is an Internet service that translates domain names into IP addresses. The DNS server address is the IP address of a server that performs this service.

- Normally, DHCP discovers DNS address information; you only need to change this if DHCP is unused or not functional. Contact your LAN administrator for details.
- This setting is non-volatile; it will not be changed by power cycling or ***RST** or **SYSTem:PRESet**.
- **Front Panel:[Utility] > I/O Config > LAN Settings > Modify Settings**
Then set the first softkey to **Manual** and press **More** and **Primary DNS** or **Second DNS** to enter a DNS address using the front panel arrow keys.
- **SCPI: SYSTem:COMMunicate:LAN:DNS[{{1|2}}] "<address>"**
- If you change this parameter, you must either press the **Apply Changes** softkey (front panel) or send **SYSTem:COMMunicate:LAN:UPDate** (remote interface) for the change to take effect.

Current Configuration (LAN)

- Press **[Utility] > I/O Config > LAN Settings** to view the MAC address and current LAN configuration. There is no equivalent SCPI command.
- If the instrument goes into remote, all LAN changes will be canceled and the display will go to a different screen. Re-selecting the LAN Settings page will display the new settings if a LAN restart took place.

Web Interface

The instrument includes a built-in Web Interface for remote instrument access and control over LAN via a Web browser. For details, see [Web Interface](#).

LAN Configuration Procedure

There are several parameters that you might need to set to establish network communication using the LAN interface. Primarily, you will need to establish an IP address. You might need to contact your network administrator for help in establishing communication with the LAN interface.

NOTE If your instrument has the secure (SEC) option, the instrument must be unsecured to change most LAN settings.

1. Press [Utility] > I/O Config > LAN Settings.
2. You can select **Modify Settings** to change the LAN settings, or you can turn LAN Services on and off or restore the LAN settings to default values.

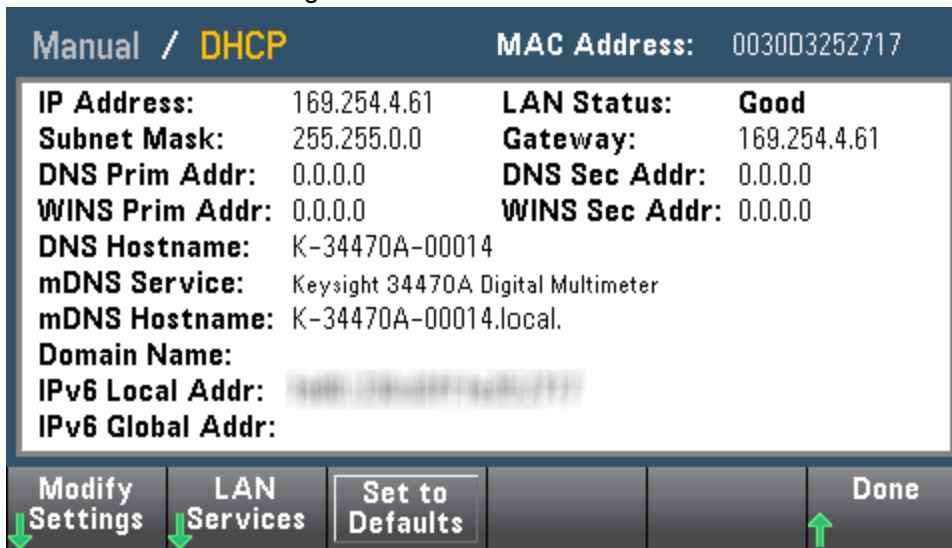

3. To change settings, press **Modify Settings**. To access most items on this screen, use the first softkey to switch from **DHCP** to **Manual**. With DHCP on, an IP address will automatically be set by DHCP (Dynamic Host Configuration Protocol) when you connect the instrument to the network, provided the DHCP server is found and is able to do so. DHCP also automatically deals with the subnet mask, gateway address, DNS, WINS, and domain name, if required. This is typically the easiest way to establish LAN communication for your instrument; all you need to do is leave DHCP on. Contact your LAN administrator for details.
4. **Establish an "IP Setup."**
If you are not using DHCP (the first softkey is set to **Manual**), you must establish an IP setup, including an IP address, and possibly a subnet mask and gateway address. The **IP Address** and **Subnet Mask** buttons are on the main screen, and you press **More** to configure the Gateway.

Contact your network administrator for the IP address, subnet mask, and gateway to use. All IP addresses take the dot-notation form "nnn.nnn.nnn.nnn" where "nnn" in each case is a byte value in the range 0 through 255. You can enter a new IP address using the front panel arrow keys. **Do not enter leading zeros.**

5. Configure the "DNS Setup" (optional)

DNS (Domain Name Service) is an Internet service that translates domain names into IP addresses. Ask your network administrator whether DNS is in use, and if it is, for the host name, domain name, and DNS server address to use.

- a. Set the "hostname." Press **Host Name** and enter the hostname. A hostname is the host portion of the domain name, which is translated into an IP address. The hostname is entered as a string using the front panel arrow keys to select and change characters. The hostname may include letters, numbers, and dashes ("-").
- b. Set the "DNS Server" addresses. From the LAN configuration screen, press **More** to go to the second of three sets of softkeys.

Enter the Primary DNS and Second DNS. See your network administrator for details.

More about IP Addresses and Dot Notation

Dot-notation addresses ("nnn.nnn.nnn.nnn" where "nnn" is a byte value from 0 to 255) must be expressed with care, as most PC web software interprets byte values with leading zeros as octal (base 8) numbers. For example, "192.168.020.011" is actually equivalent to decimal "192.168.16.9" because ".020" is interpreted as "16" expressed in octal, and ".011" as "9". To avoid confusion, use only decimal values from 0 to 255, with no leading zeros.

Firmware Update

Use the following procedure to update instrument firmware:

CAUTION Do not turn off the instrument during the update.

1. Press **[Help] > About** to determine what instrument firmware version is currently installed.
2. Go to www.keysight.com/find/truevolt and use the links there to find the latest firmware version. If this matches the version installed on your instrument, there is no need to continue with this procedure. Otherwise, download the firmware update utility and a ZIP file of the firmware. Detailed firmware instructions are in the *Firmware Update Utility Instructions* located on the download page.
3. Unzip the ZIP file and use the firmware update utility to prepare a USB drive with the updated firmware:
4. Attach the USB drive to the instrument front panel and press **[Utility] > Test / Admin > Firmware Update** to update the firmware. If the security option is installed, unlock the instrument with the security code before installing firmware.

Important: In order to update the instrument firmware *from remote*, the model number in the ***IDN?** response must match the actual instrument model number. If you have changed the instrument's ***IDN?** response to another instrument, when attempting to update the firmware from remote, you will see this error: *The instrument is not supported by this firmware file.* To update the firmware, either update using the front panel procedure or, from remote, use **SYSTem:IDENtify** to set the ***IDN?** to match the actual model number, update the firmware, and then use **SYSTem:IDENtify** again to set the ***IDN?** response to the other model number.

Contacting Keysight Technologies



You can contact Keysight Technologies for warranty, service, or technical support.

In the United States: (800) 829-4444

In Europe: 31 20 547 2111

In Japan: 0120-421-345

Use www.keysight.com/find/assist to contact Keysight worldwide, or contact your Keysight Technologies representative.

Quick Start

This section describes basic procedures to help you get started quickly with the instrument.

- [Prepare Instrument for Use](#)
- [Adjust the Carrying Handle](#)
- [Use Built-in Help System](#)
- [Rack Mount the Instrument](#)

Prepare Instrument for Use

Verify that you received the following items. If anything is missing, please contact your nearest Keysight sales office or Keysight authorized reseller.

- Power cord (for country of destination)
- Certificate of Calibration (optional)
- *Keysight Automation-Ready CD* (Keysight IO Libraries Suite) (optional on 34460A)
- Supplemental documentation packet
- USB 2.0 cable (optional on 34460A)

The latest product documentation is available at www.keysight.com/find/truevolt-doc. For documentation for mobile devices, see www.keysight.com/find/truevolt-mobilehelp.

To download the Digital Multimeter Connectivity Utility, go to www.keysight.com/find/DMMutilitysoftware.

Setting the AC Mains Line Voltage Selector and Fuse Installation

WARNING

Before plugging the instrument into AC mains power, verify that the line voltage setting visible on the back of the AC mains input module is correct for the AC mains power source being connected. The line voltage selections are shown in a box on the rear panel immediately to the left of the AC mains input module. Other nominal line voltages are shown in parentheses.

Verify that the correct fuse is installed. To replace a blown fuse or verify the correct fuse,

pull it gently from the fuse drawer and insert the correct working fuse. Use only a 5x20 mm,

time-lag, 0.25 A, 250 V certified fuse. The Keysight part number is 2110-0817.

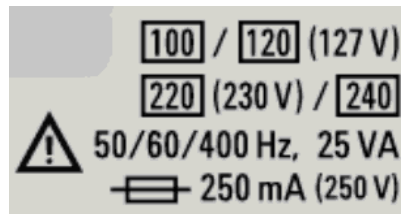

AC MAINS Nominal Line Voltage Range	AC Mains Line Voltage Selector
100 - 115	100
120 - 127	120
202 - 230	220
240	240

Quick Start

Use the following procedure to configure the line voltage selector:

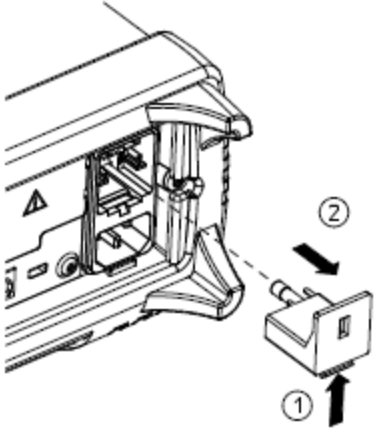
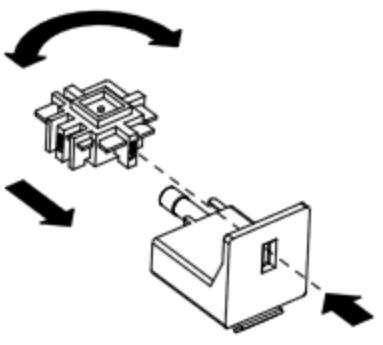
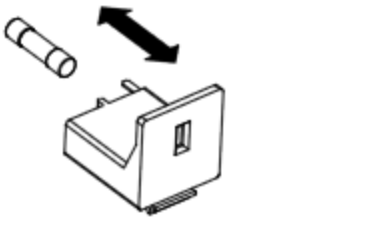
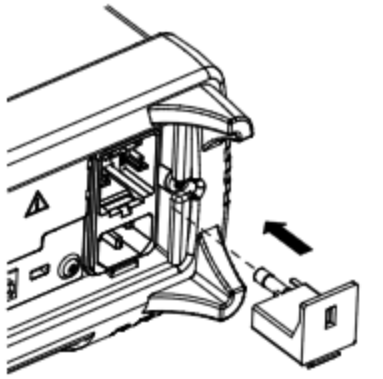
Step 1	Lift tab (1) and pull the fuse drawer (2) from the rear panel.	
Step 2	Remove the line-voltage selector and rotate it so the correct voltage will appear in the fuse holder window.	
Step 3	Verify that the correct fuse is installed. To replace a blown fuse or verify the correct fuse, pull it gently from the fuse drawer and insert the correct working fuse. Use only a 5x20 mm, time-lag, 0.25 A, 250 V certified fuse. The Keysight part number is 2110-0817.	
Step 4	Replace the fuse holder assembly by sliding it into the rear panel.	

WARNING Product Grounding

The instrument is a Class 1 product and is provided with a grounding-type power cord set. The instrument chassis and cover are connected to the instrument electrical ground to minimize shock hazard. The ground pin of the cord set plug must be firmly connected to the electrical ground (safety ground) terminal at the power outlet. Any interruption of the protective earth (grounding) conductor or disconnection of the protective earth terminal will cause a potential shock hazard that could result in personal injury or death.

Connect Power and I/O Cables

Connect the power cord and LAN, GPIB, or USB cable as desired. After you turn on the instrument (as described below), the instrument will run a power-on self test and then display a message about how to obtain help, along with the current IP address. It also displays the GPIB address (if applicable).

The instrument's default measurement function is DC Voltage (DCV), with autoranging enabled.

Power Switch

Press the power switch in the lower left corner of the front panel. If the instrument does not turn on, verify that the power cord is firmly connected and that the fuse is good and the line voltage selector is set correctly, as described above. Also make sure that the instrument is connected to an energized power source. If the LED below the power switch is off, there is no AC mains power connected. If the LED is amber, the instrument is in standby mode with AC mains power connected, and if it is green, the instrument is on.

NOTE In certain circumstances, the amber LED can come on even if the wrong line voltage is selected. In this case, the instrument may not power on.

If the power-on self test fails, the display shows **Error** in the upper right corner. It also displays a message describing the error. See [SCPI Error Messages](#) for information on error codes. See [Service and Repair - Introduction](#) for instructions on returning the instrument for service.

To turn off the instrument, press and hold the power switch for about 500 ms. This prevents you from accidentally turning off the instrument by brushing against the power switch.

NOTE If you turn off the instrument by disconnecting power (this is not recommended), the instrument turns on as soon as you re-apply power. You will not need to press the power switch.

Quick Start

Adjust the Carrying Handle

The handle has three positions, shown below.

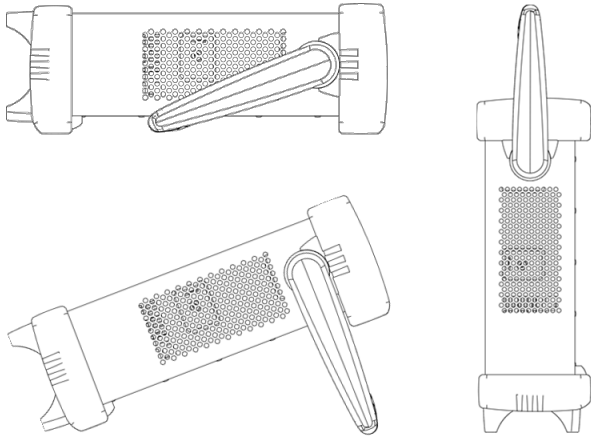

To adjust the handle position, grasp the sides of the handle, pull outward, and rotate the handle.

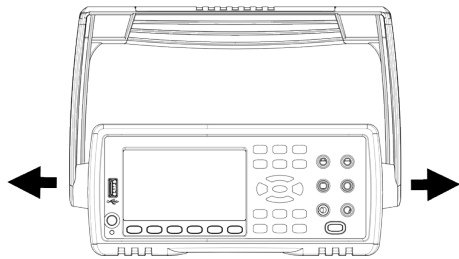

Use Built-in Help System

The built-in help system provides context-sensitive help on any front panel key or menu softkey. A list of help topics is also available to help you learn about the instrument.

View the help information for a front panel key

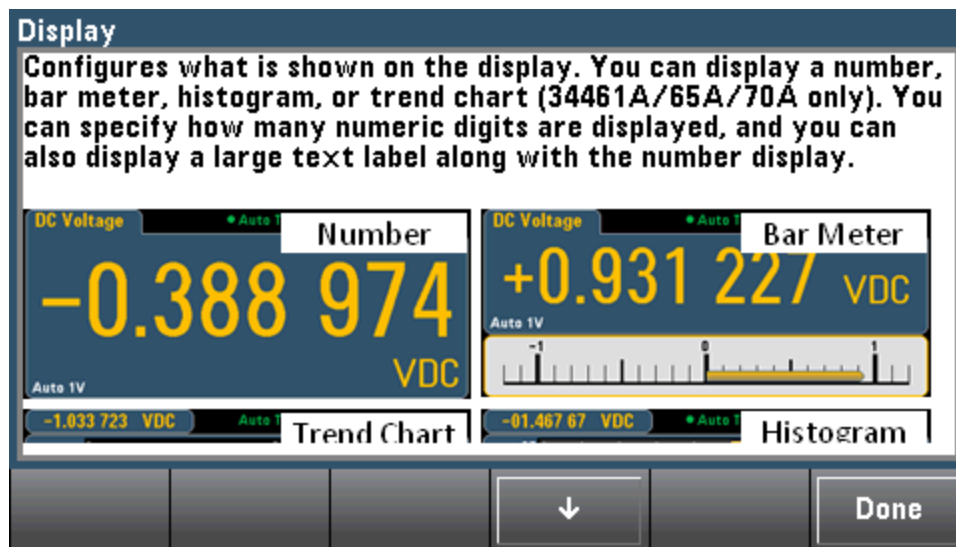

Press and hold any softkey or button, such as **[Display]**.

If the message contains more information than will fit on the display, press the down arrow softkey to scroll down.



Press **Done** to exit Help.

View the list of help topics and use interactive demos

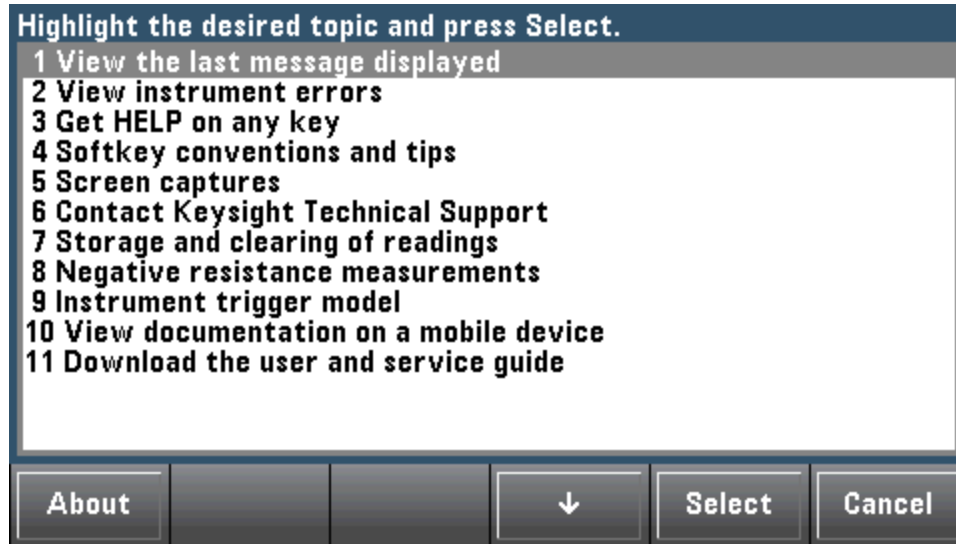

Press   to view the list of help topics. Press the arrow softkeys or use the front panel arrow keys to highlight the desired topic. Then press **Select**. You can also press **Demos** to run interactive demos on how to use the instrument.

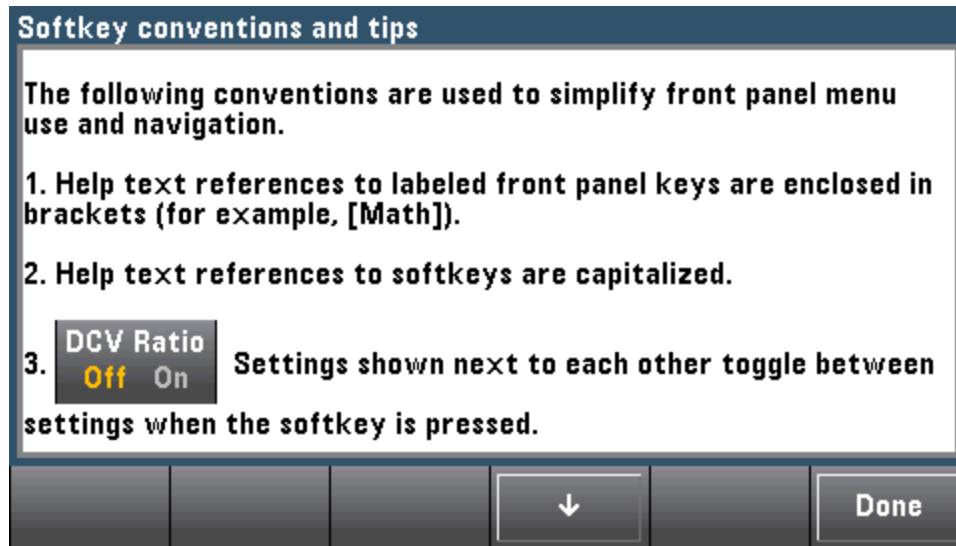

In this case, the following help topic appears:



View the list of recent instrument errors.

Press  and  and choose **View instrument errors** from the list of help topics. This displays the instrument's error queue, which includes up to 20 errors.

View the help information for displayed messages.

Whenever a limit is exceeded or any other invalid configuration is found, the instrument displays a message. The built-in help system provides additional information on the most recent message. Press **[Shift]** > **[Help]**, select **View the last message displayed**, and press **Select**.

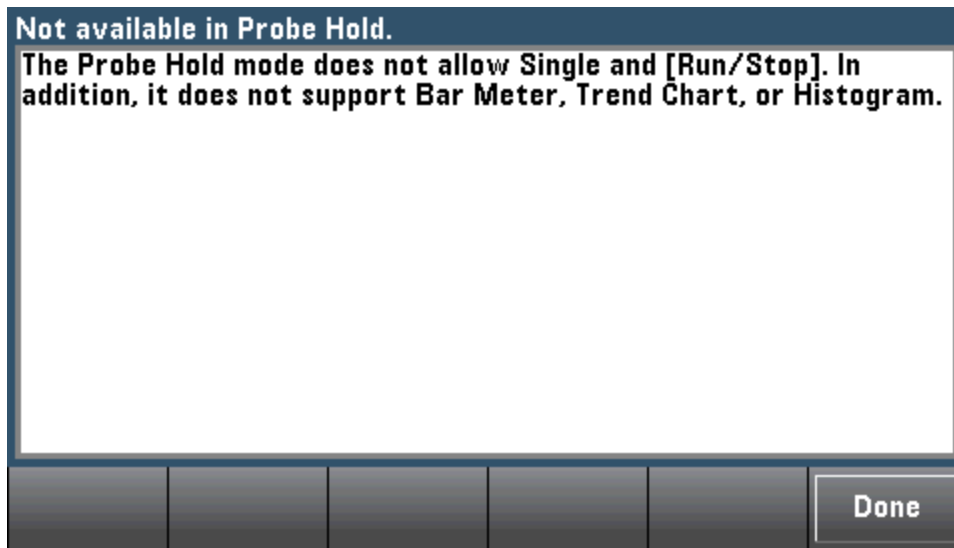

Press **Done** to exit Help.

NOTE

Local Language Help

All messages, context-sensitive help, and help topics are available in English, Chinese, French, German, Japanese, Korean, and Russian. To select the local language, press **[Utility]** > **System Setup** > **User Settings** > **Help Lang**. Then select the desired language.

The menu softkey labels and status line messages are not translated.

Rack Mount the Instrument

You can mount the instrument in a standard 19-inch rack cabinet using one of two optional kits, each of which includes instructions and mounting hardware. You may also mount Another Keysight System II instrument of the same height and width beside the instrument.

CAUTION

To prevent overheating, do not block airflow to or from the instrument. Allow enough clearance at the rear, sides, and bottom of the instrument to permit adequate internal air flow.

NOTE

Remove the carrying handle and the front and rear bumpers before rack-mounting the instrument.

Removing the Handle and Bumpers

To remove the handle, rotate it to vertical and pull the ends outward.

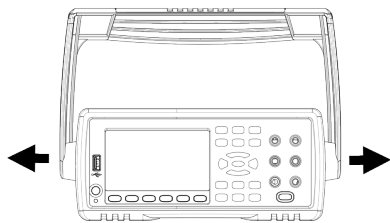

To remove the rubber bumper, stretch a corner and then slide it off.

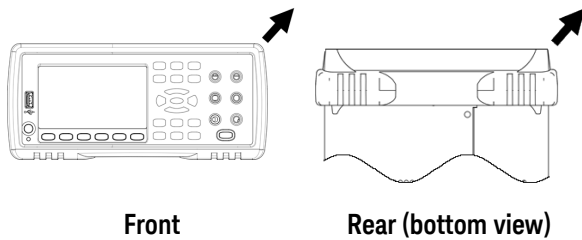

Rack Mounting a Single Instrument

To rack mount a single instrument, order adapter kit 5063-9240.

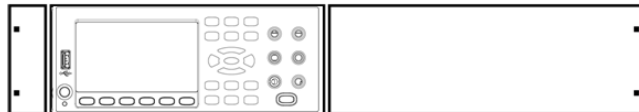

Removing the Front Panel Side Screws and Washers

NOTE

This step is valid for instrument model with serial number stated below:

- 34461A and 34470A: serial number MY60020599 onwards
- 34460A and 34465A: serial number MY60016557 onwards

To remove the side screws and washer, use Ponzi driver size 2.

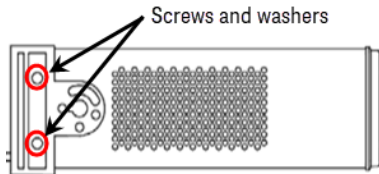

Rack Mounting Instruments Side-by-Side

To rack mount two instruments side-by-side, order lock-link kit 5061-8769 and flange kit 5063-9212. Be sure to use the support rails in the rack cabinet.

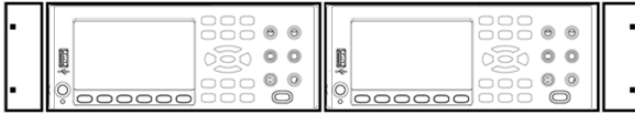

Sliding Support Shelf

To install one or two instruments in a sliding support shelf, order shelf 5063-9255 and slide kit 1494-0015. For a single instrument, also order filler panel 5002-3999.

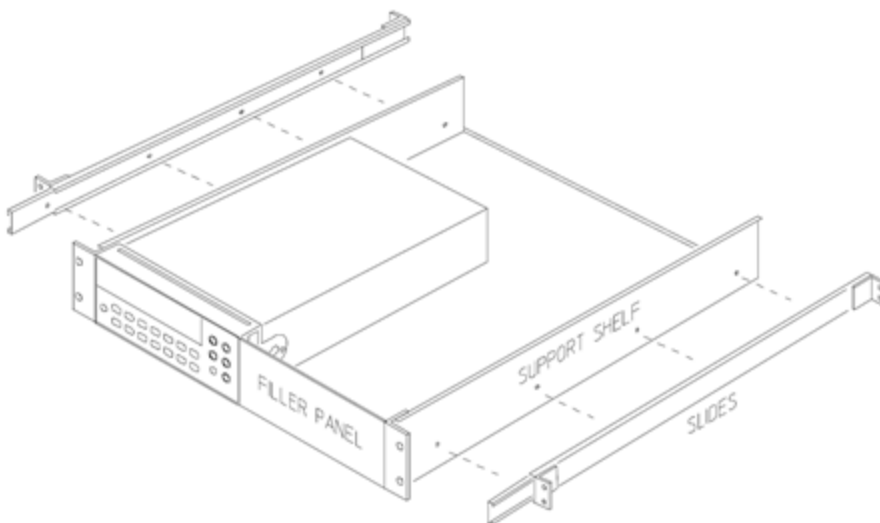

Features and Functions

This section contains details on instrument features, including front panel and remote interface operation. Read the [Front Panel Menu Reference](#) first. See [Introduction to SCPI Language](#) for details on SCPI commands and queries.

This section covers:

[Front Panel Menu Reference](#)

[Measurements](#)

[Triggering and Readings](#)

[Probe Hold](#)

[Math Menu](#)

[Display Menu](#)

[Utility Menu](#)

[Web Interface](#)

Throughout this document, "default" states and values are identified. These are the **power-on default states** when the instrument is shipped from the factory.

Continuous, Data Log, and Digitize Modes

The 34465A/70A can operate in the continuous, data log, or digitize mode as described below.

NOTE The 34460A/61A DMMs always operate in the continuous mode -data log and digitize modes are not available on these models.

Continuous Mode

Continuous mode is the default mode for all Truevolt DMMs. With the factory default settings, the DMM continuously makes DCV measurements with autorange and autozero on, NPLC set to 10 PLCs, etc. (see factory defaults for details).

Data Log Mode

The Data Log mode is standard on the 34465A and 34470A only, as is available only from the DMM's front panel. Data Log mode provides a front-panel user interface that allows you to set up data logging into the instrument's non-volatile memory, or to internal/external file(s), without programming, and without a connection to a computer. Once you have finished collecting data, you can view it from the front panel, or you can transfer the data to your computer. Data Log mode allows you to log a specified number of readings, or readings acquired for a specified period of time, to instrument memory or to internal or external data files.

To select Data Log mode, press **[Acquire] Acquire > Data Log**. You can then select the Sample Interval (time between measurements - for example, 500 ms), Duration as either an amount of Time or a number of Readings, whether to Start after a Delay or at a specific Time of Day, and whether to Log to Memory or Log to File(s). After configuring the data logging parameters, press **[Run/Stop]**. Data logging will begin following the specified Delay or at the specified Time of Day.

Digitize Mode

The digitize mode applies only to the 34465A/70A with the DIG option, and as is available only from the DMM's front panel. The digitized mode provides a front-panel user interface that allows you to quickly set up digitized measurements.

Digitizing is the process of converting a continuous analog signal, such as a sine wave, into a series of discrete samples (readings). The figure below shows the result of digitizing a sine wave. This chapter discusses the various ways to digitize signals. The importance of the sampling rate, and how to use level triggering.

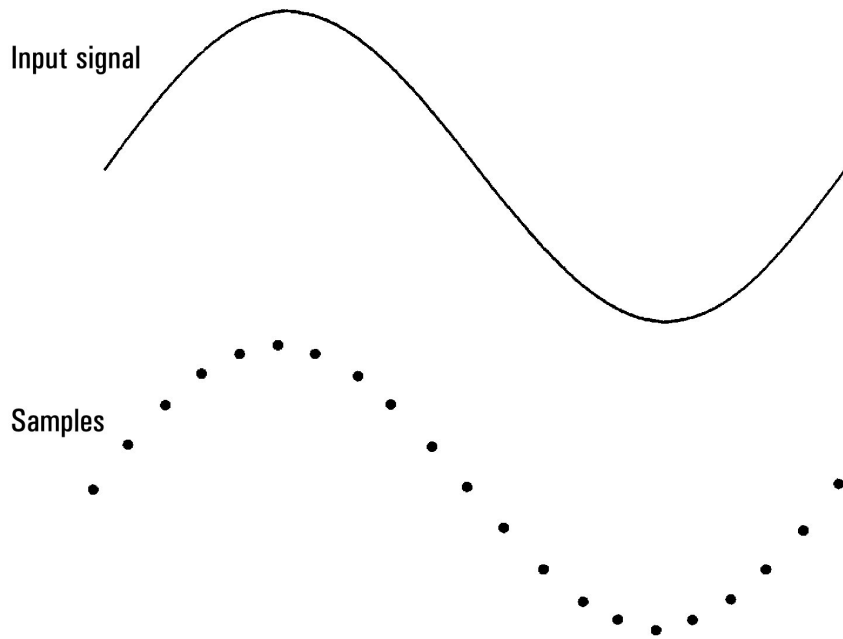

Data Log and Digitize Mode Default Settings

On entering data log or digitize mode, the DMM configures these settings:

- Trigger count set to 1 (trigger count is normally infinite when in Local and is not settable from the front panel).
- Secondary measurements are turned off.
- Math smoothing is turned off.
- Statistics are cleared.
- Histogram is cleared.
- Trend chart is changed from the continuous, bucketized mode, to simple data graph.

Additional Data Log Default Settings

On entering data log mode, the DMM configures these settings:

- Trigger source is set to auto.
- Trigger delay is set to auto.
- Pretrigger count is set to zero.
- Samples per trigger is set according to the data log duration (time or samples).
- Sample timer is put in timer (not immediate) mode and sample time is set according to the data log sample interval.









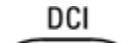

Additional Digitize Default Settings



On entering digitize mode, the DMM configures these settings:

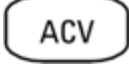

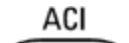
- If trigger source is set to manual it is changed to auto. (external and level remain as is.)
- Limits mode is turned off.
- Scaling is turned off.
- Statistic and histogram are put in post-processing mode (computed after digitize is complete).
- On the selected function (DCV or DCI) and for the new function if changed:
 - Autorange is turned off.
 - Autozero is turned off.
 - NPLC and aperture are set to their minimum values.
- If trigger source is external or level, the pretrigger count is set to the digitize pretrigger count setting (default of 0).
- Samples per trigger is set according to the digitize duration (time or samples).
- Sample timer is put in timer (not immediate) mode and Sample timer is set according to the digitize sample rate or sample interval.
- Trend Chart mode is changed to bucketized when data logging to a file.
- On return to Continuous mode, settings are left as done in data log or digitize mode except:
 - Sample source is set to immediate.
 - Pretrigger count is set to 0.
 - Samples per trigger is set to 1.
 - Trigger count is set to infinite.



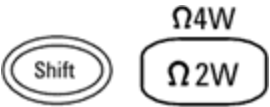



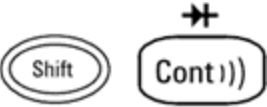











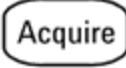

Front Panel Menu Reference

The following table summarizes the front panel keys and the menu structure.

Key	Purpose
 	<p>Configure DC voltage measurements, including DCV ratio measurements:</p> <p>Range: Autorange (default), 100 mV, 1 V, 10 V, 100 V, or 750 V</p> <p>Aperture NPLC: 0.02, 0.2, 1, 10, 100. Default: 10 (34460A/61A) 0.02, 0.06, 0.2, 1, 10, 100. Default: 10 (34465A/70A without DIG option) 0.001, 0.002, 0.006, 0.02, 0.06, .2, 1, 10, 100. Default: 10 (34465A/70A with DIG option)</p> <p>See Range, Resolution and NPLC for more information.</p> <p>Aperture Time (applies only to the 34465A and 34470A): (<i>Without</i> the DIG option) 200 μs to 1 s (2 μs resolution), default: 100 ms. (<i>With</i> the DIG option) 20 μs to 1 s (2 μs resolution), default: 100 ms.</p> <p>Auto Zero: Off or On (default)</p> <p>Input Z: 10 MΩ (default) or HighZ (> 10 GΩ)</p> <p>DCV Ratio: Off (default) or On</p>
  	<p>Configure DC current measurements:</p> <p>Terminals: 3 A or 10 A</p> <p>Range: Auto, 100 μA, 1 mA, 10 mA, 100 mA, 1 A, 3 A, or 10 A (when terminals set to 10 A). The 34465A and 34470A have additional 1 μA and 10 μA DC current ranges.</p> <p>Aperture NPLC: 0.02, 0.2, 1, 10, 100. Default: 10 (34460A/61A) 0.02, 0.06, 0.2, 1, 10, 100. Default: 10 (34465A/70A without DIG option) 0.001, 0.002, 0.006, 0.02, 0.06, .2, 1, 10, 100. Default: 10 (34465A/70A with DIG option)</p> <p>See Range, Resolution and NPLC for more information.</p> <p>Aperture Time (applies only to the 34465A and 34470A): (<i>Without</i> the DIG option) 200 μs to 1 s (2 μs resolution), default: 100 ms. (<i>With</i> the DIG option) 20 μs to 1 s (2 μs resolution), default: 100 ms.</p> <p>Auto Zero: Off or On (default)</p>
 	<p>Configure AC voltage measurements:</p> <p>Range: Autorange (default), 100 mV, 1 V, 10 V, 100 V, or 750 V</p> <p>Filter: >3 Hz, >20 Hz, >200 Hz</p>
  	<p>Configure AC current measurements:</p> <p>Terminals: 3 A or 10 A</p> <p>Range: Auto, 100 μA, 1 mA, 10 mA, 100 mA, 1 A, 3 A, or 10 A (when terminals set to 10 A)</p> <p>Filter: >3 Hz, >20 Hz, >200 Hz</p>

Key	Purpose
	<p>Configure 2-wire resistance measurements:</p> <p>Range: 100 Ω, 1 kΩ, 10 kΩ, 100 kΩ, 1 MΩ, 10 MΩ, 100 MΩ, 1 GΩ (34465A and 34470A only) or Auto (default). Note: The approximate current sourced for each range (for example, ~1mA) is shown on each range softkey.</p> <p>Aperture NPLC: 0.02, 0.2, 1, 10, 100. Default: 10 (34460A/61A) 0.02, 0.06, 0.2, 1, 10, 100. Default: 10 (34465A/70A without DIG option) 0.001, 0.002, 0.006, 0.02, 0.06, .2, 1, 10, 100. Default: 10 (34465A/70A with DIG option)</p> <p>See Range, Resolution and NPLC for more information.</p> <p>Aperture Time (applies only to the 34465A and 34470A): (<i>Without</i> the DIG option) 200 μs to 1 s (2 μs resolution), default: 100 ms. (<i>With</i> the DIG option) 20 μs to 1 s (2 μs resolution), default: 100 ms.</p> <p>Auto Zero: Off or On (default)</p> <p>OffstComp: Off (default) or ON. Applies only to the 34465A and 34470A.</p> <p>Low Power: Disables (Off) or enables (On) low power measurements. Applies only to the 34465A and 34470A.</p>
	<p>Configure 4-wire resistance measurements.</p> <p>Range: 100 Ω, 1 kΩ, 10 kΩ, 100 kΩ, 1 MΩ, 10 MΩ, 100 MΩ, 1 GΩ (34465A and 34470A only) or Auto (default). Note: The approximate current sourced for each range (for example, ~1mA) is shown on each range softkey.</p> <p>Aperture NPLC: 0.02, 0.2, 1, 10, 100. Default: 10 (34460A/61A) 0.02, 0.06, 0.2, 1, 10, 100. Default: 10 (34465A/70A without DIG option) 0.001, 0.002, 0.006, 0.02, 0.06, .2, 1, 10, 100. Default: 10 (34465A/70A with DIG option)</p> <p>See Range, Resolution and NPLC for more information.</p> <p>Aperture Time (applies only to the 34465A and 34470A): (<i>Without</i> the DIG option) 200 μs to 1 s (2 μs resolution), default: 100 ms. (<i>With</i> the DIG option) 20 μs to 1 s (2 μs resolution), default: 100 ms.</p> <p>OffstComp: Off (default) or ON. Applies only to the 34465A and 34470A.</p> <p>Low Power: Disables (Off) or enables (On) low power measurements. Applies only to the 34465A and 34470A.</p>
	<p>Configure frequency and period measurements. Parameters include range, AC filter, and gate time.</p> <p>Range: 100 mV, 1 V, 10 V, 100 V, 750 V, Auto (default)</p> <p>Filter: >3 Hz, >20 Hz, >200 Hz</p> <p>Gate Time: 10 ms, 100 ms (default), or 1 s</p> <p>Timeout: 1 s (default) or Auto</p>
	<p>Configure capacitance measurements:</p> <p>Range: 1 nF, 10 nF, 100 nF, 1 μF, 10 μF, 100 μF, or Auto (default)</p>

Key	Purpose
	Configure continuity measurements: Beeper: Off or On (default)
	Configure diode measurements: Beeper: Off or On (default)
	Configure 2-wire and 4-wire temperature measurements. Probe Settings: RTD 2w, RTD 4w (default), Thermis2w, Thermis4w, TCouple (34465A/70A only) Additional settings for probe type RTD 2w or RTD 4w: <ul style="list-style-type: none"> • R0: R_0 is the nominal resistance of an RTD at 0 °C. Default 100 Ω • Low Power: Disables (Off) or enables (On) low power measurements. Applies only to the 34465A and 34470A. Additional settings for probe type Thermis2w and Thermis4w: <ul style="list-style-type: none"> • Low Power: Disables (Off) or enables (On) low power measurements. Applies only to the 34465A and 34470A. Additional settings for probe type TCouple: <ul style="list-style-type: none"> • Type: J (default), K, E, T, N, or R • Reference: Internal or Fixed • Offset Adjust: (Available for an internal reference only). -20 °C to +20 °C. Default: 0 °C. • Fixed Offset: (Available for a fixed reference only) -20 °C to +80 °C. Default: 0 °C. Aperture NPLC: 0.02, 0.2, 1, 10, 100. Default: 10 (34460A/61A) 0.02, 0.06, 0.2, 1, 10, 100. Default: 10 (34465A/70A without DIG option) 0.001, 0.002, 0.006, 0.02, 0.06, .2, 1, 10, 100. Default: 10 (34465A/70A with DIG option) See Range, Resolution and NPLC for more information. Aperture Time (applies only to the 34465A and 34470A): (<i>Without</i> the DIG option) 200 μ s to 1 s (2 μ s resolution), default: 100 ms. (<i>With</i> the DIG option) 20 μ s to 1 s (2 μ s resolution), default: 100 ms. Auto Zero: Off or On (default) (2-wire measurements only; not available for 4-wire measurements) OffstComp: Off (default) or ON. (RTD 2-wire and RTD 4-wire measurements only) Open Check: TCouple measurements only.* Units: °C, °F, or K
	Start and stop measurements.

Key	Purpose
 	<p>Reset the instrument for front panel use; equivalent to SYST:PRESet.</p>
	<p>Take a single measurement.</p>
 	<p>Take one or more hands-free measurements.</p>
	<p>Take a null measurement.</p>
 	<p>Configure the null function, smoothing filter (applies only to the 34465A and 34470A), scaling, statistics, and limits.</p>
	<p>Configure the text and graphics that appear on the display and secondary measurements.</p>
 	<p>Store and recall instrument states and preferences. Configure I/O interfaces: LAN (optional on 34460A), USB, GPIB (optional). Perform system administration tasks, including calibration. Configure user preferences. Perform file management activities, including the creation of "screen shot" files (display images).</p>
 	<p>Learn about the instrument, learn how to download or view documentation, view the last error message, or clear error messages.</p>
 	<p>Perform autocalibration (34465A/70A only).</p>
	<p>Select manual or auto ranging. Press  to manually uprange,  to manually downrange.</p>
	<p>Return to local control of the instrument (when in Remote mode), or indicate that the next front panel key will be "shifted", for example [Probe Hold] instead of [Single].</p> 

The keys that access a wide range of functions are listed below.

[Acquire] key



Softkey	Description
Acquire	Select Continuous mode (default measurement mode), Digitize mode, or Data Log mode.*
Trigger Settings	Configure triggering.
VMC Out	Set slope of VM Comp output.
Save Readings	Save readings to a file.

* Digitize and Data Log modes are available only on the 34465A/70A. The Digitize mode requires the DIG option.

[Math] key



The availability of the Math softkeys varies by measurement function.

Softkey	Description
Null	Enable/disable use of null values and specify null value to use.
Smoothing Filter	(34465A/70A only) Smoothing uses a moving average (boxcar) filter to reduce random noise in measurements. Smoothing is intended to average out small variations in the measurements. Larger variations will cause the filter to reset.
dB / dBm	(34460A/61A only) Configure dB, dBm
Scaling	(34465A/70A only) Configure scaling: dB, dBm, %, Mx-B
Statistics	Enable, disable, and clear statistics.
Limits	Enable or disable high and low limits.

[Display] key



Softkey	Description
Display	Choose what is displayed: number, bar meter, histogram, or trend chart (34461A/65A/70A only).
Label	Enable or disable the display of a message.
Label Text	Edit the text displayed when the Label softkey is On.
2nd Meas	Select a secondary measurement.
Digit Mask	Set the number of digits displayed for measurements.

[Utility] key



Softkey	Description
Store/Recall	Store and recall state and preference files and set power-on defaults.
Manage Files	Perform basic file management tasks and screen captures.
I/O Config	Configure LAN (optional on 34460A), USB, and GPIB (optional) interfaces.
Test/Admin	Perform self-test, calibration, security, license, and firmware update tasks.
System Setup	Set user preferences, date and time, and power-on message.

Measurements

The Keysight Truevolt DMMs support many common measurements:

DC Voltage

AC Voltage

DC Current

AC Current

Resistance

Temperature

Capacitance

Continuity

Diode

Frequency and Period

Data Logging

Digitizing

Level Triggering

DC Voltage

This section describes how to configure DC voltage measurements from the front panel, including DCV ratio measurements.

Step 1: Configure the test leads as shown.

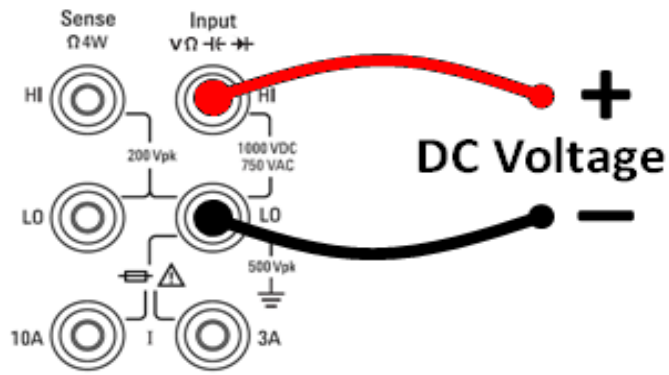

Step 2: Press [DCV] on the front panel.

Step 3:

- For the 34460A/61A, press **Aperture** and choose the number of power-line cycles (PLCs) to use for the measurement. Only 1, 10, and 100 PLC provide normal mode (line frequency noise) rejection. Selecting 100 PLC provides the best noise rejection and resolution, but the slowest measurements:

Range Auto	Aperture 10 PLC	Auto Zero Off On	Input Z 10M Auto	DCV Ratio Off On
---------------	--------------------	---------------------	---------------------	---------------------

Select # of Power Line Cycles				
100 PLC	10 PLC	1 PLC	0.2 PLC	0.02 PLC

- For the 34465A/70A, the **Aperture NPLC** softkey is selected by default. Use the up/down arrow keys to specify integration time in power-line cycles (PLCs) to use for the measurement . 1, 10, and 100 PLC provide normal mode (line frequency noise) rejection. Selecting 100 PLC provides the best noise rejection and resolution, but the slowest measurements:



To set integration time precisely, instead of using PLCs, press **Aperture Time** and use the left/right up/down arrow keys to specify integration time in seconds. For **Aperture Time**, you can specify from 200 μ s (20 μ s with the DIG option) to 1 s integration time (2 μ s resolution):

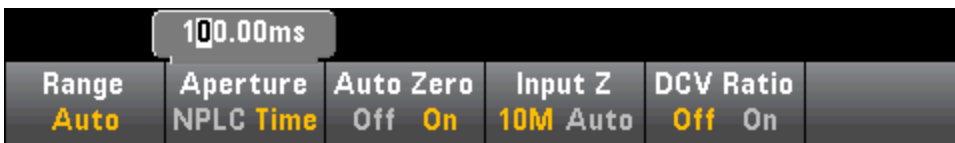

Step 4: Press **Range** to select a range for the measurement. You can also use the [+], [-], and [Range] keys on the front panel to select the range. (**Auto** (autorange) automatically selects the range for the measurement based on the input. Autoranging is convenient, but it results in slower measurements than using a manual range. Autoranging goes up a range at 120% of the present range, and down a range below 10% of the present range.



Step 5: Auto Zero: Autozero provides the most accurate measurements, but requires additional time to perform the zero measurement. With autozero enabled (On), the DMM internally measures the offset following each measurement. It then subtracts that measurement from the preceding reading. This prevents offset voltages present on the DMM’s input circuitry from affecting measurement accuracy. With autozero disabled (Off), the DMM measures the offset once and subtracts the offset from all subsequent measurements. The DMM takes a new offset measurement each time you change the function, range, or integration time. (There is no autozero setting for 4-wire measurements.)

Step 6: Specify the input impedance to the test leads (**Input Z**). This specifies the measurement terminal input impedance, which is either Auto or 10 M Ω . The Auto mode selects high impedance (HighZ) for the 100 mV, 1 V and 10 V ranges, and 10 M Ω for the 100 V and 1000 V ranges. In most situations, 10 M Ω is high enough to not load most circuits, but low enough to make readings stable for high impedance circuits. It also leads to readings with less noise than the **HighZ** option, which is included for situations where the 10 M Ω load is significant.

DCV Ratio

The **DCV Ratio** key enables or disables DCV Ratio measurement. Note that the **Auto Zero** softkey disappears when you enable DCV Ratio measurements. This is because autozero cannot be disabled during DCV Ratio.

The ratio is the voltage on the Input terminals divided by the reference voltage. The reference voltage is the difference of two separate measurements. These measurements are the DC voltages from the HI Sense terminal to the LO Input terminal and from the LO Sense terminal to the LO Input terminal. These two measurements must be within the range of ± 12 VDC. The reference voltage is always autoranged, and the range used for both will be based on the larger result of these two measurements.

Configure DCV Ratio measurements as shown:

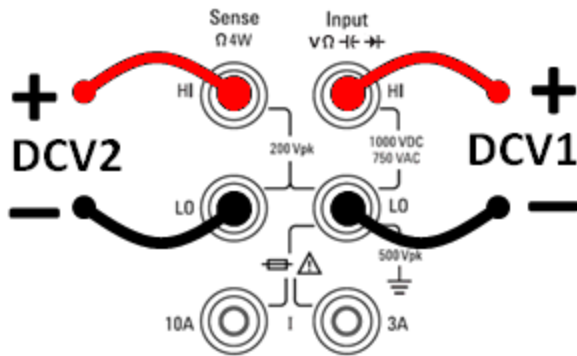

AC Voltage

This section describes how to configure AC voltage measurements from the front panel.

NOTE Default delays are selected to give correct first readings for most measurements. For the most accurate measurements, the input blocking RC time constant must settle to 1/50 of the AC signal level.

Signals greater than 300 V (rms) or 1 A (rms) will cause self-heating in signal-conditioning components. These errors are included in the instrument specifications. Internal temperature changes due to self-heating may cause additional error on other functions or ranges. The additional error will generally dissipate within a few minutes.

For example, consider a 100 mVAC signal with a 10 VDC bias. The 10 VDC bias should be settled to 1/50 of 100 mVAC, or 2 mVDC. The corresponding settling time can be calculated using the blocking RC time constant of 0.22 s as follows:

$$\text{settling time} = \ln(\text{bias}/\text{settled value}) * 0.22 \text{ s}$$

$$\text{settling time} = \ln(10 \text{ VDC} / 2 \text{ mVDC}) * 0.22 \text{ s}$$

$$\text{settling time} = \ln(5000) * 0.22 \text{ s} = 1.9 \text{ s}$$

This additional settling delay should be applied after connecting the signal to the DMM's ACV input or after selecting the ACV function with the signal already connected. If the DC bias remains constant, subsequent measurements can be made to full accuracy without additional settling delays.

Step 1: Configure the test leads as shown.

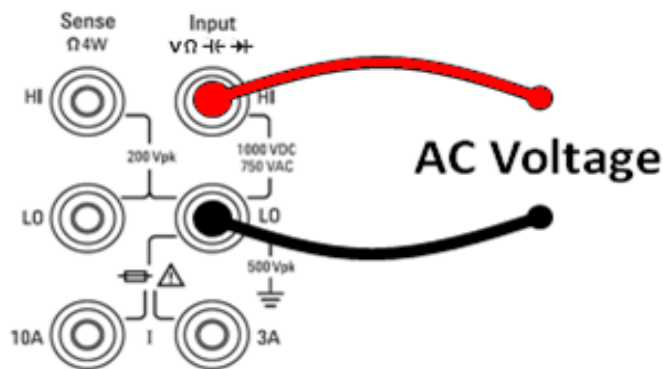

Step 2: Press [ACV] on the front panel.

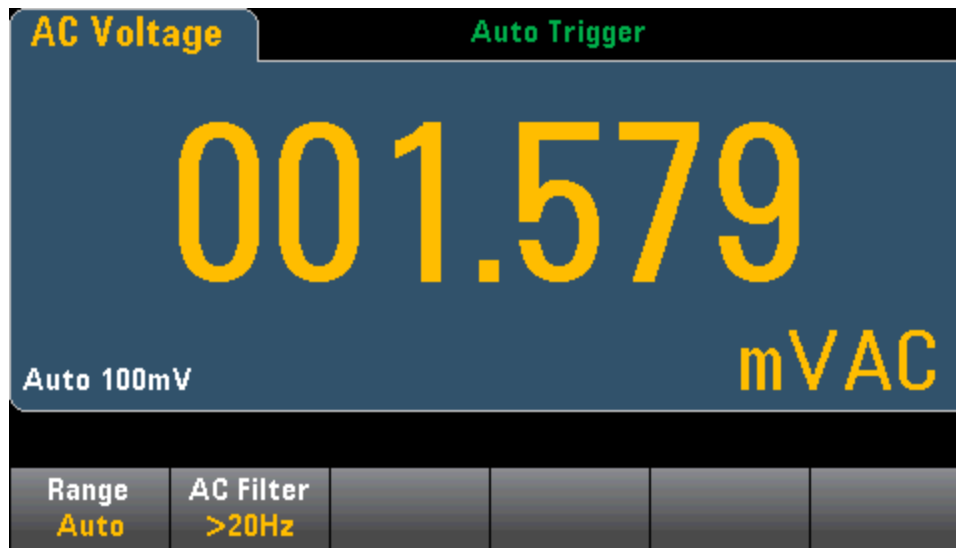

Step 3: Press **Range** to select a range for the measurement. (**Auto** (autorange) automatically selects the range for the measurement based on the input. Autoranging is convenient, but it results in slower measurements than using a manual range. Autoranging goes up a range at 120% of the present range, and down a range below 10% of the present range.



Step 4: Press **AC Filter** and choose the filter for the measurement. The instrument uses three different AC filters that enable you either to optimize low frequency accuracy or to achieve faster AC settling times following a change in input signal amplitude.

The three filters are 3 Hz, 20 Hz, and 200 Hz, and you should generally select the highest frequency filter whose frequency is less than that of the signal you are measuring, because higher frequency filters result in faster measurements. For example, when measuring a signal between 20 and 200 Hz, use the 20 Hz filter.

If measurement speed is not an issue, choosing a lower frequency filter may result in quieter measurements, depending on the signal that you are measuring.



NOTE For accurate displayed statistics of AC measurements in Front Panel mode, the default manual trigger delay ([**Acquire**] > **Delay Man**) must be used.

DC Current

CAUTION Do not exceed the maximum current rating for DC current measurement. Exceeding the maximum current rating can cause a fuse to blow.

This section describes how to configure DC current measurements from the front panel.

Step 1: Configure the test leads as shown.

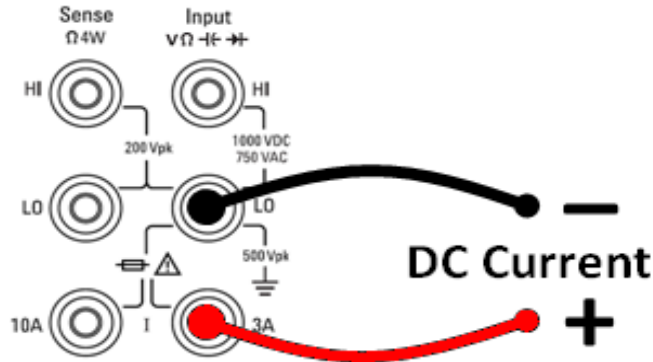

On the 34461A/65A/70A, you can also configure the measurement using the 10 A terminal, which is recommended when measuring current above 1 A:

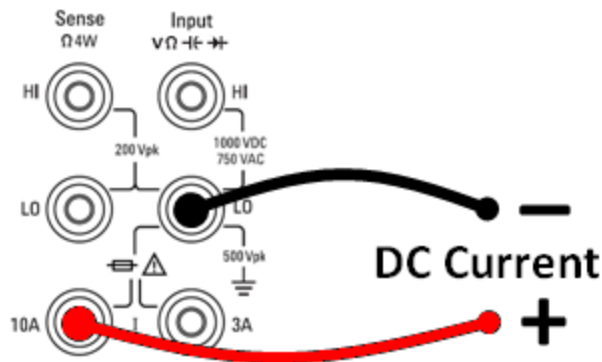

Step 2: Press [DCI] on the front panel.



Step 3: For the 34465A/70A, the Aperture NPLC softkey is selected by default. Use the up/down arrow keys to specify integration time in power-line cycles (PLCs) to use for the measurement . 1, 10, and 100 PLC provide normal mode (line frequency noise) rejection. Selecting 100 PLC provides the best noise rejection and resolution, but the slowest measurements:

Step 4 (34461A/65A/70A only): The 3A terminals are selected by default. The **Terminals** softkey toggles between the 3 A terminals and the 10 A input terminals. When you change this to 10 A, the measurement range automatically becomes 10 A.

Step 5: Press **Range** to select a range for the measurement. You can also use the **[+]**, **[-]**, and **[Range]** keys on the front panel to select the range. (**Auto** (autorange) automatically selects the range for the measurement based on the input. Autoranging is convenient, but it results in slower measurements than using a manual range. Autoranging goes up a range at 120% of the present range, and down a range below 10% of the present range. Press **More** to switch between the two pages of settings.

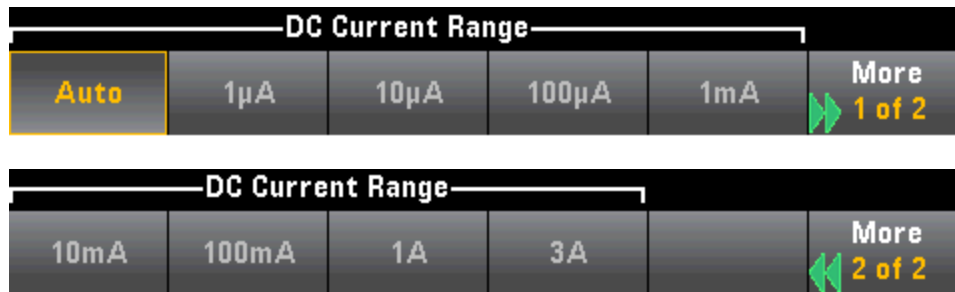

Step 6: Auto Zero: Autozero provides the most accurate measurements, but requires additional time to perform the zero measurement. With autozero enabled (On), the DMM internally measures the offset following each measurement. It then subtracts that measurement from the preceding reading. This prevents offset voltages present on the DMM's input circuitry from affecting measurement accuracy. With autozero disabled (Off), the DMM measures the offset once and subtracts the offset from all subsequent measurements. The DMM takes a new offset measurement each time you change the function, range, or integration time. (There is no autozero setting for 4-wire measurements.)

AC Current

CAUTION Do not exceed the maximum current rating for AC current measurement. Exceeding the maximum current rating can cause a fuse to blow.

This section describes how to configure AC current measurements from the front panel.

Step 1: Configure the test leads as shown.

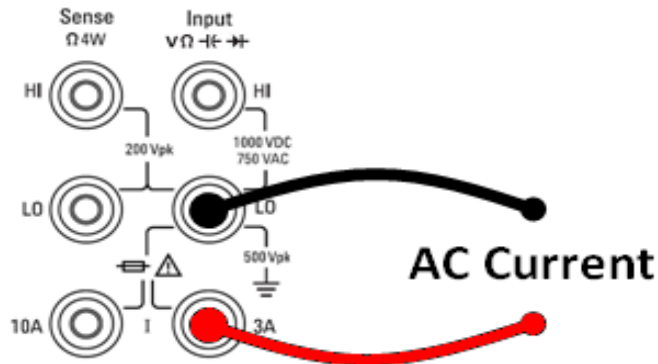

On the 34461A/65A/70A, you can also configure the measurement using the 10 A terminal, which is recommended when measuring current above 1 A:

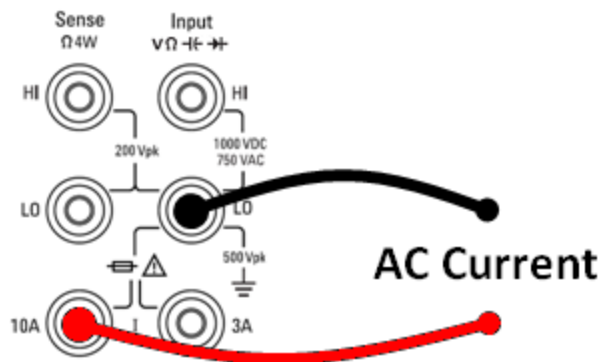

Step 2: Press [ACI] on the front panel.

Terminals	Range	AC Filter			
3A 10A	Auto	>20Hz			

Step 3 (34461A/65A/70A only): The 3A terminals are selected by default. The **Terminals** softkey toggles between the 3 A terminals and the 10 A input terminals. When you change this to 10 A, the measurement range automatically becomes 10 A.

CAUTION When making measurements using the 10A terminals, the presence of a signal on the 3A terminals can cause significant errors.

Step 4: Press **Range** to select a range for the measurement. You can also use the **[+]**, **[-]**, and **[Range]** keys on the front panel to select the range. (**Auto** (autorange) automatically selects the range for the measurement based on the input. Autoranging is convenient, but it results in slower measurements than using a manual range. Autoranging goes up a range at 120% of the present range, and down a range below 10% of the present range. Press **More** to switch between the two pages of settings.

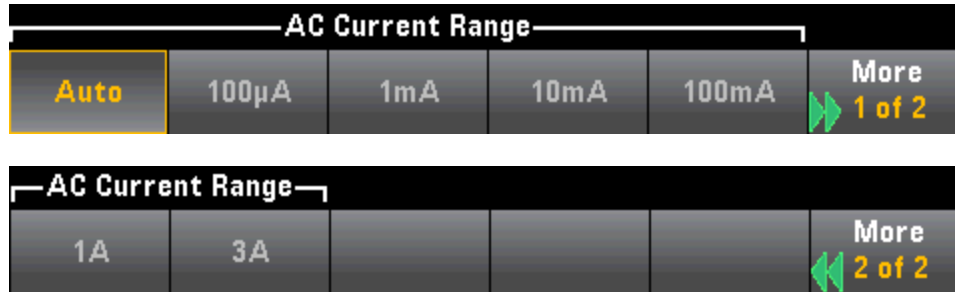

Step 5: Press **AC Filter** and choose the filter for the measurement. The instrument uses three different AC filters that enable you either to optimize low frequency accuracy or to achieve faster AC settling times following a change in input signal amplitude.

The three filters are 3 Hz, 20 Hz, and 200 Hz, and you should generally select the highest frequency filter whose frequency is less than that of the signal you are measuring, because higher frequency filters result in faster measurements. For example, when measuring a signal between 20 and 200 Hz, use the 20 Hz filter.

If measurement speed is not an issue, choosing a lower frequency filter may result in quieter measurements, depending on the signal that you are measuring.



NOTE For accurate displayed statistics of AC measurements in Front Panel mode, the default manual trigger delay (**[Acquire] > Delay Man**) must be used.

Resistance

This section describes how to configure 2-wire and 4-wire resistance measurements from the front panel.

Step 1: Configure the test leads as shown.

2-wire Resistance:

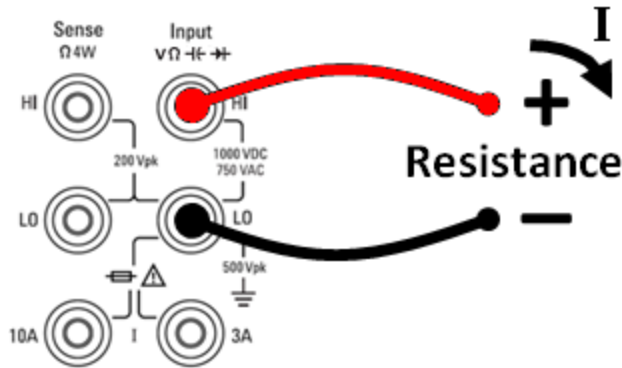

4-wire Resistance:

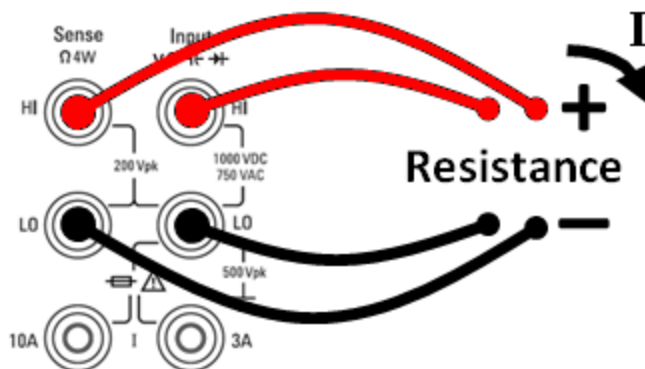

Step 2: Press [$\Omega 2W$] or [$\Omega 4W$] on the front panel. The following menu appears. (The $\Omega 4W$ menu does not include **Auto Zero**.)

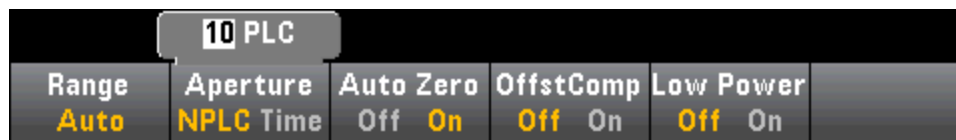

Step 3: For the 34465A/70A, the Aperture NPLC softkey is selected by default. Use the up/down arrow keys to specify integration time in power-line cycles (PLCs) to use for the measurement. 1, 10, and 100 PLC provide normal mode (line frequency noise) rejection. Selecting 100 PLC provides the best noise rejection and resolution, but the slowest measurements:

Step 4: Press **Range** to select a range for the measurement. (**Auto** (autorange) automatically selects the range for the measurement based on the input. Autoranging is convenient, but it results in slower measurements than using a manual range. Autoranging goes up a range at 120% of the present range, and down a range below 10% of the present range. Press **More** to switch between the two pages of settings.



Notice the amount of test current sourced is shown for each range. After selecting a range, the main resistance menu is displayed.



Step 5: Auto Zero: Autozero provides the most accurate measurements, but requires additional time to perform the zero measurement. With autozero enabled (On), the DMM internally measures the offset following each measurement. It then subtracts that measurement from the preceding reading. This prevents offset voltages present on the DMM's input circuitry from affecting measurement accuracy. With autozero disabled (Off), the DMM measures the offset once and subtracts the offset from all subsequent measurements. The DMM takes a new offset measurement each time you change the function, range, or integration time. (There is no autozero setting for 4-wire measurements.)

Step 6: OffstComp (34465A/70A only): Enables or disables offset compensation. Offset compensation removes the effects of small dc voltages in the circuit being measured. The technique involves taking the difference between two resistance measurements, one with the current source set to the normal value, and one with the current source set to a lower value. Enabling Offset Compensation approximately doubles the reading time.

Step 7: Low Power (34465A/70A only): The low power mode sources less test current per measurement range than is normally sourced for standard resistance measurements, to reduce power dissipation and self-heating in the DUT. With low power On, pressing **Range** displays the lower current sourced for each range:



Low-power resistance measurements apply to the 100Ω through 100kΩ ranges only. The 1 MΩ through 1 GΩ ranges source the same current regardless of the low-power setting.

Negative Resistance Measurements

Under certain conditions, the instrument may report negative resistance measurements. These may occur in 2-wire and 4-wire resistance measurements or continuity measurements.

Conditions that may cause negative ohms values include:

- Changes in Front/Rear switch contact resistance
- Reversed Sense Hi and Lo leads
- Circuits with external bias or thermal voltages at circuit connections
- Changes in measurement connection after a NULL operation

Under the same conditions, the 34401A returns the measurement's absolute value so as to prevent the confusion associated with negative readings. The Keysight Truevolt Series DMMs will return negative values. This allows the most accurate results after a NULL operation.

Temperature (34460A and 34461A)

This topic applies only to 34460A/61 DMMs. For temperature measurements using the 34465A/70A, see [Temperature \(34465A and 34470A\)](#).

This section describes how to configure 2-wire and 4-wire temperature measurements from the front panel.

Step 1: Configure the test leads as shown.

2-wire Temperature:

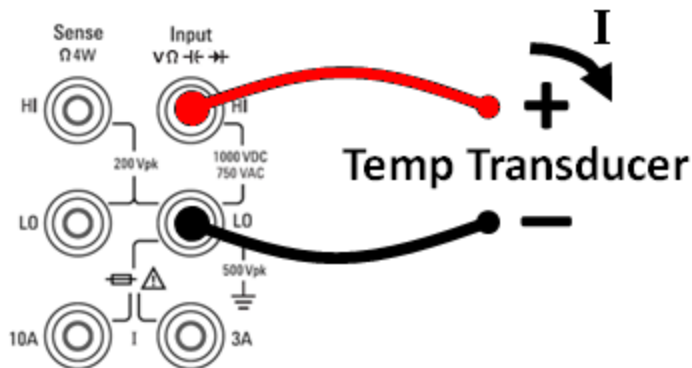

4-wire Temperature:

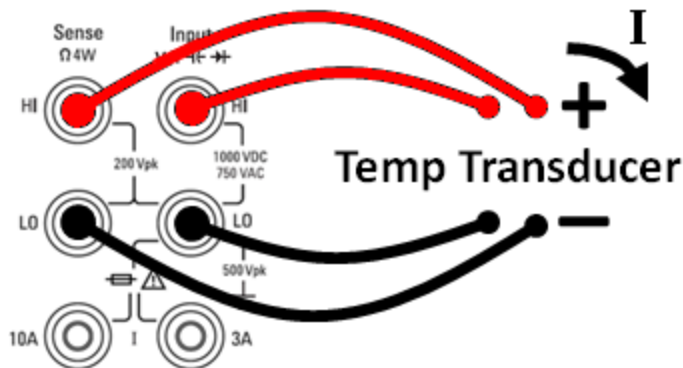

Step 2: Press [Temp] on the front panel. The following menu appears.

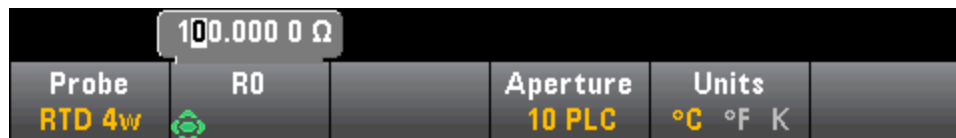

Step 3: Press **Probe** and choose the probe type. If you choose to use an RTD, the menu will have a softkey to specify the RTD's resistance at 0 degrees Celsius (R_0).



Step 4: For 2-wire measurements, an **Auto Zero** softkey is available.

Auto Zero: Autozero provides the most accurate measurements, but requires additional time to perform the zero measurement. With autozero enabled (On), the DMM internally measures the offset following each measurement. It then subtracts that measurement from the preceding reading. This prevents offset voltages present on the DMM's input circuitry from affecting measurement accuracy. With autozero disabled (Off), the DMM measures the offset once and subtracts the offset from all subsequent measurements. The DMM takes a new offset measurement each time you change the function, range, or integration time. (There is no autozero setting for 4-wire measurements.)

Step 5: Press **Aperture** and choose the number of power-line cycles (PLCs) to use for the measurement. Only 1, 10, and 100 PLC provide normal mode (line frequency noise) rejection. Selecting 100 PLC provides the best noise rejection and resolution, but the slowest measurements:



Step 6: Use the **Units** softkey to display temperature in degrees Celsius, degrees Fahrenheit, or Kelvin.

Temperature (34465A and 34470A)

This topic applies only to 34465A/70 DMMs. For temperature measurements using the 34460A/61A, see [Temperature \(34460A and 34461A\)](#).

This section describes how to configure temperature measurements from the front panel. Temperature measurements require a temperature transducer probe. The supported probes are 2-wire and 4-wire RTDs, 2-wire and 4-wire thermistors (2.2 k Ω 44004 type, 5 k Ω 44007 type and 10 k Ω 44006 type, see [Thermistor Requirements](#)), and type E, J, K, N, R, or T thermocouples.

NOTE This section describes general temperature measurement configuration information. For a detailed tutorial on temperature measurements, refer to Keysight Application Note 290 *Practical Temperature Measurements* available at www.keysight.com.

Step 1: Configure the test leads as shown.

2-wire Temperature:

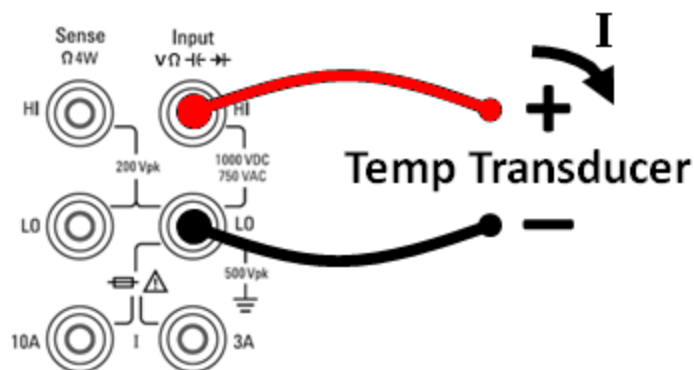

4-wire Temperature:

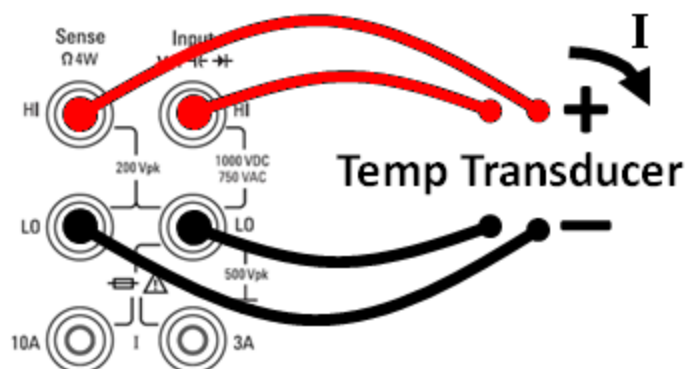

Step 2: Press [Temp] on the front panel.

Step 3: The **Aperture NPLC** softkey is selected by default. Use the up/down arrow keys to specify integration time in power-line cycles (PLCs) to use for the measurement. 1, 10, and 100 PLC provide normal mode (line frequency noise) rejection. Selecting 100 PLC provides the best noise rejection and resolution, but the slowest measurements:



To set integration time precisely, instead of using PLCs, press **Aperture Time** and use the left/right up/down arrow keys to specify integration time in seconds. For **Aperture Time**, you can specify from 200 μ s (20 μ s with the DIG option) to 1 s integration time (2 μ s resolution):



Step 4: Use the **Units** softkey to display temperature in degrees Celsius, degrees Fahrenheit, or Kelvin.

Step 5: Press **Probe Settings**, the default probe settings are:



Step 6: To select another probe type, press **Probe** and press one of the softkeys:

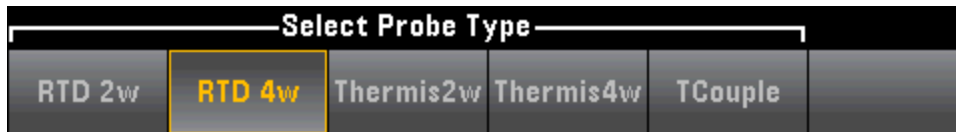

Additional settings for each probe type are described in the sections below.

For the RTD 2w or RTD 4w Probe Type...

The RTD 2w or RTD 4w probe types allow you to set R0 and to enable/disable offset compensation and/or the low-power mode:



R0: R_0 is the nominal resistance of an RTD at 0 °C. Default 100 Ω

OffstComp Enables or disables offset compensation. Offset compensation removes the effects of small dc voltages in the circuit being measured. The technique involves taking the difference between two resistance measurements, one with the current source set to the normal value, and one with the current source set to a lower value. Enabling Offset Compensation approximately doubles the reading time.

Low Power: Disables (Off) or enables (On) low power measurements. The low power mode sources less test current per measurement range than is normally sourced for standard resistance measurements, to reduce power dissipation and self-heating in the probe.

Press **Done** to return to the main temperature menu.

For the RTD 2w probe type, an additional **Auto Zero** setting is available:



Auto Zero: Autozero provides the most accurate measurements, but requires additional time to perform the zero measurement. With autozero enabled (On), the DMM internally measures the offset following each measurement. It then subtracts that measurement from the preceding reading. This prevents offset voltages present on the DMM's input circuitry from affecting measurement accuracy. With autozero disabled (Off), the DMM measures the offset once and subtracts the offset from all subsequent measurements. The DMM takes a new offset measurement each time you change the function, range, or integration time. (There is no autozero setting for 4-wire measurements.)

For the Thermis2w or Thermis4w Probe Type...

The Thermis2w or Thermis4w probe types allow you to enable/disable low power mode:



Low Power: Disables (Off) or enables (On) low power measurements. The low power mode sources less test current per measurement range than is normally sourced for standard resistance measurements, to reduce power dissipation and self-heating in the probe.

Press **Done** to return to the main temperature menu. For the **Thermis2w** probe type, an additional **Auto Zero** setting is available:



Auto Zero: Autozero provides the most accurate measurements, but requires additional time to perform the zero measurement. With autozero enabled (On), the DMM internally measures the offset following each measurement. It then subtracts that measurement from the preceding reading. This prevents offset voltages present on the DMM's input circuitry from affecting measurement accuracy. With autozero disabled (Off), the DMM measures the offset once and subtracts the offset from all subsequent measurements. The DMM takes a new offset measurement each time you change the function, range, or integration time. (There is no autozero setting for 4-wire measurements.)

Thermistor Requirements

The DMM converts the measured thermistor resistance to temperature using the Steinhart-Hart thermistor equation:

$$1/T = A + B (\ln(R)) + C (\ln(R))^3$$

Where:

Features and Functions

A, B, and C are constants provided by the thermistor manufacturer and derived from three temperature test points.

R = Thermistor resistance in Ω .

T = Temperature in degrees K.

Important: Use only a 2.2 k Ω 44004 type, 5 k Ω 44007 type or 10 k Ω 44006 type thermistor. Using an incorrect type of thermistor can result in errors greater than 20 °C for a temperature being measured of 100 °C.

For a detailed tutorial on temperature measurements, refer to Keysight Application Note 290 *Practical Temperature Measurements* available at www.keysight.com.

For the TCouple Probe Type...

The TCouple probe types allows these settings:

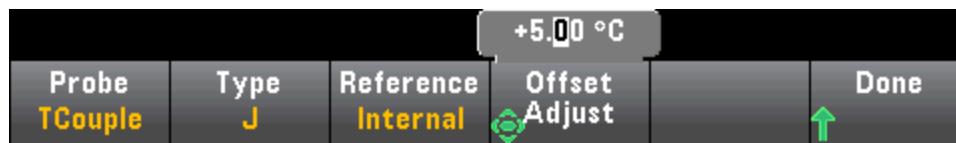

Type: Select the type of thermocouple. Supported types are J (default), K, E, T, N, or R

Reference: Thermocouple measurements require a reference junction temperature. You can input a known fixed reference junction temperature (typically used for external reference junctions) or use the internally measured temperature of the front terminals as the reference junction temperature. Select internal or fixed reference.

Important: Since the internal reference temperature is the temperature of the *front* connections, use of the *rear* connections with the selection of the internal reference junction will have an unknown error with no specified performance and is not recommended.

Offset Adjust: Allows you to make minor temperature adjustments to correct for the differences between the DMM internal temperature measurement of the front connection and the actual temperature of the measurement terminals. When you select the internal reference junction, the internal temperature measurement of the front terminals plus the specified offset value is used as the reference junction temperature. For example, if the measured internal temperature is +20.68 °C and the specified offset is +5 °C, the artificial cold junction mathematics uses the sum of the two values. Keysight recommends that the offset be left at 0 unless metrology has indicated otherwise.

Fixed Offset: When you select the external reference junction, you must specify the reference junction temperature in degrees Celsius. Enter a value from -20 °C to +80 °C. Default: 0 °C. For example, to set the fixed reference temperature to +23.36 °C:



Press **Done** to return to the main temperature menu showing additional settings for thermocouple measurements:



Auto Zero: Autozero provides the most accurate measurements, but requires additional time to perform the zero measurement. With autozero enabled (On), the DMM internally measures the offset following each measurement. It then subtracts that measurement from the preceding reading. This prevents offset voltages present on the DMM's input circuitry from affecting measurement accuracy. With autozero disabled (Off), the DMM measures the offset once and subtracts the offset from all subsequent measurements. The DMM takes a new offset measurement each time you change the function, range, or integration time. (There is no autozero setting for 4-wire measurements.)

Open Check: Disables or enables the *thermocouple check* feature to verify that your thermocouples are properly connected for measurements. When enabled, the instrument measures the resistance after each thermocouple measurement to ensure a proper connection. If an open connection is detected (greater than 5 k Ω on the 10 k Ω range), the instrument reports an overload condition.

For more information about making temperature measurements refer to Keysight Application Note 290 *Practical Temperature Measurements* available at www.keysight.com.

Capacitance

This section describes how to configure capacitance measurements from the front panel.

Step 1: Configure the test leads as shown.

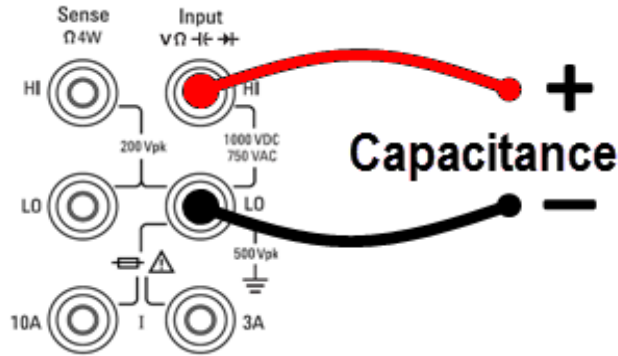

Step 2: Press   on the front panel.

Step 3: To null-out the test lead capacitance:

- Disconnect the + and - test leads probe end from the test circuit, and leave open.
- Press **Null**. The DMM will now subtract this null value from capacitance measurements.

Step 4: Press **Range** to select a range for the measurement. You can also use the **[+]**, **[-]**, and **[Range]** keys on the front panel to select the range. (**Auto** (autorange) automatically selects the range for the measurement based on the input. Autoranging is convenient, but it results in slower measurements than using a manual range. Autoranging goes down a range at less than 10% of range and up a range at greater than 120% of range. For capacitance measurements only, when autorange is off, the instrument does not report an overload for readings greater than 120% of range. Overload only occurs when the algorithm times out because the applied capacitance is too large for the algorithm to measure. If you apply a DC voltage or a short to the input terminals in capacitance measurement mode, the instrument reports an overload.



Continuity

This section describes how to configure continuity tests from the front panel.

Step 1: Configure the test leads as shown.

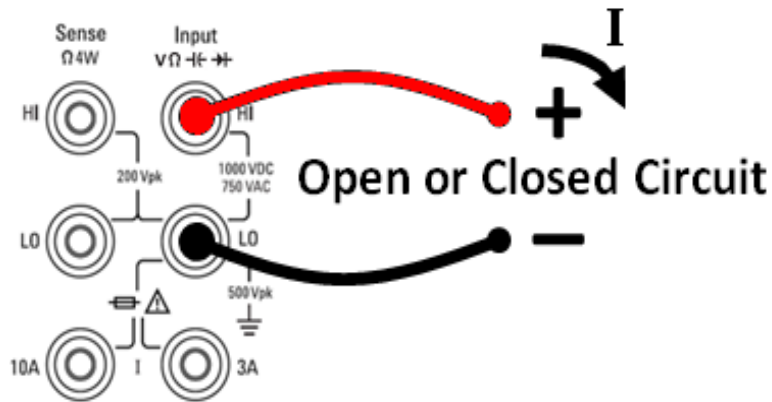

Step 2: Press [**Cont**] on the front panel to open a menu where you can enable or disable the beeper for all functions that use the beeper (limits, probe hold, diode, continuity, and errors).



Continuity measurements behave as follows:

$\leq 10 \Omega$	displays measured resistance and beeps (if beeper enabled)
10Ω to $1.2 \text{ k}\Omega$	displays measured resistance without beeping
$> 1.2 \text{ k}\Omega$	displays OPEN with no beep

Diode

This section describes how to configure diode tests from the front panel. The range and resolution are fixed; the range is 10 VDC (with a 1 mA current source output).

Step 1: Configure the test leads as shown.

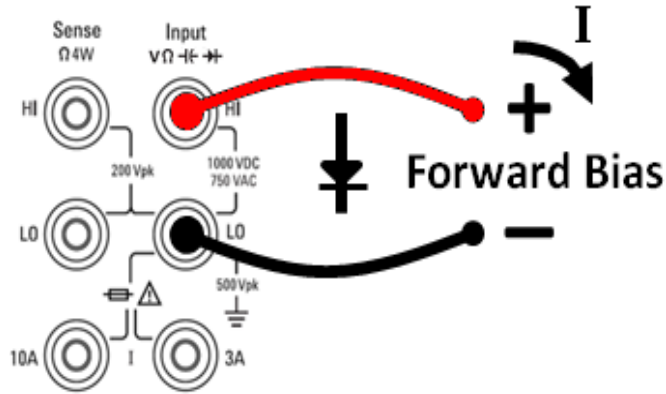

Step 2: Press  on the front panel to open a menu that specifies whether the DMM will beep to indicate a successful diode test.



Diode measurements behave as follows:

0 to 5 V	voltage displayed on the front panel, and instrument beeps when signal transitions into the 0.3 to 0.8 V threshold (if beeping is enabled)
> 5 V	the front panel displays OPEN, and SCPI returns 9.9E37

Frequency and Period

This section describes how to configure frequency and period measurements from the front panel.

Step 1: Configure the test leads as shown.

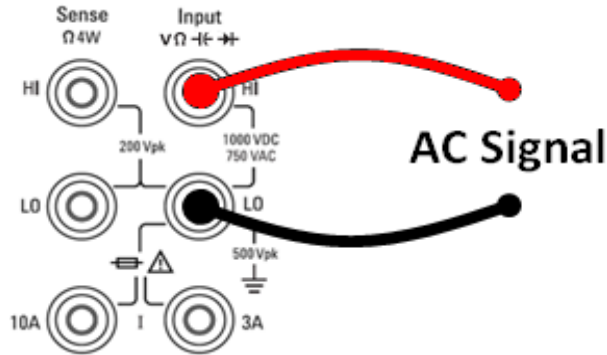

Step 2: Press [**Freq**] on the front panel and then use the first softkey to choose either frequency or period measurement.

Freq Period	Range Auto	AC Filter >20Hz	Gate Time 100ms	Timeout 1s	
-----------------------	----------------------	---------------------------	---------------------------	----------------------	--

Step 3: Press **Range** to select a range for the measurement. (**Auto** (autorange) automatically selects the range for the measurement based on the input. Autoranging is convenient, but it results in slower measurements than using a manual range. Autoranging goes up a range at 120% of the present range, and down a range below 10% of the present range.

Select Frequency Voltage Range					
Auto	100mV	1V	10V	100V	750V

Step 4: Press **AC Filter** and choose the filter for the measurement. The instrument uses three different AC filters that enable you either to optimize low frequency accuracy or to achieve faster AC settling times following a change in input signal amplitude.

The three filters are 3 Hz, 20 Hz, and 200 Hz, and you should generally select the highest frequency filter whose frequency is less than that of the signal you are measuring, because higher frequency filters result in faster measurements. For example, when measuring a signal between 20 and 200 Hz, use the 20 Hz filter.

If measurement speed is not an issue, choosing a lower frequency filter may result in quieter measurements, depending on the signal that you are measuring.

Select AC Filter					
>3Hz	>20Hz	>200Hz			

Step 5: Press **Gate Time** and choose the measurement aperture (integration time) of 1 ms (34465A/70A only) 10 ms, 100 ms (default), or 1 s.



Step 6: (34465A/70A only) Press **Timeout** to control how long the instrument waits before timing out on a frequency or period measurement when no signal is present. When set to 1s, the instrument waits 1 second before timing out. When set to Auto, the wait time varies with AC filter bandwidth; for the faster bandwidths, the instrument waits a shorter time before timing out and returning 0.0. This is advantageous in manufacturing test systems where a DUT failure may result in no signal; in this case, the failure can be detected sooner, speeding up test throughput.



NOTE For accurate displayed statistics of AC measurements in Front Panel mode, the default manual trigger delay ([Acquire] > Delay Man) must be used.

Data Logging

The Data Log mode is standard on the 34465A and 34470A only, as is available only from the DMM's front panel. Data Log mode provides a front-panel user interface that allows you to set up data logging into the instrument's non-volatile memory, or to internal/external file(s), without programming, and without a connection to a computer. Once you have finished collecting data, you can view it from the front panel, or you can transfer the data to your computer. Data Log mode allows you to log a specified number of readings, or readings acquired for a specified period of time, to instrument memory or to internal or external data files.

To select Data Log mode, press **[Acquire] Acquire > Data Log**. You can then select the Sample Interval (time between measurements - for example, 500 ms), Duration as either an amount of Time or a number of Readings, whether to Start after a Delay or at a specific Time of Day, and whether to Log to Memory or Log to File(s). After configuring the data logging parameters, press **[Run/Stop]**. Data logging will begin following the specified Delay or at the specified Time of Day.

Data Log mode can be used with the DC voltage, DC current, AC voltage, AC current, 2-wire and 4-wire resistance, frequency, period, temperature, capacitance, and ratio measurement functions (diode and continuity are excluded). The maximum reading rate is 1000 readings/s and the maximum duration is 100 hours resulting in a maximum number of readings of 360,000,000 to file. The number of readings you can log to memory depends on the amount of instrument memory. With the MEM option, the limit is 2,000,000 readings; without the MEM option, the limit is 50,000 readings. By default, data logging implements auto trigger. The level and external trigger sources are not supported for data logging.

CAUTION

Loss of data possible - local to remote transition clears instrument memory: When data logging or digitizing *to memory*, if you access the instrument from remote (send a SCPI or common command)* and then return to local (by pressing **[Local]**), the readings in memory are cleared and the instrument returns to Continuous mode.

For data logging only, you can prevent this situation by data logging to a file instead of to memory (see **Data Log Mode** for details). You can also prevent this from happening for data logging or digitizing by taking steps to keep the instrument from being accessed from remote. To prevent remote access, you may want to disconnect the LAN, GPIB, and USB interface cables from the instrument before starting the measurements. To prevent remote access via LAN, you can connect the instrument behind a router to minimize the possibility of remote access. You can also disable the various I/O interfaces from the front panel menus under **[Utility] > I/O Config**.

To view the status of a data logging or digitizing operation remotely, use the instrument's **Web User Interface**. The Web User Interface monitor does not set the instrument to remote.

**When accessed from remote, the instrument will continue data logging or digitizing to completion, and you can retrieve the readings from remote.*

Data Logging Overview

This section is a summary of the steps involved in setting up data logging. Detailed steps are described below in Detailed Data Logging Steps.

Features and Functions

1. Select the measurement function and make connections to the DUT (see [Measurements](#) for details).
2. Select Data Log mode (press **[Acquire]** > **Acquire** > **Data Log**).
3. Specify the sample interval (time between readings) for example, 20 ms.
4. Specify the duration as amount of time or number of readings.
5. Specify when to start data logging (delay or time of day). You can only use auto trigger (default) or single trigger (press **[Single]**) for data logging.
6. Select whether to log data to memory or internal or external data file(s).
7. Press **[Run/Stop]** or **[Single]**. Data logging starts when the specified delay has elapsed or the time of day occurs (specified in Step 5). Data logging will stop after the specified duration (time or number of readings) has occurred or after you press **[Run/Stop]** again.

Detailed Data Logging Steps

Note: For more information, on any of the softkeys described below, such as the range of values for a particular setting, press and hold the softkey to display help for that softkey.

Step 1: Select the measurement function and make connections to the DUT (see [Measurements](#) for details). For example, press **DCV** and configure the test leads as shown.

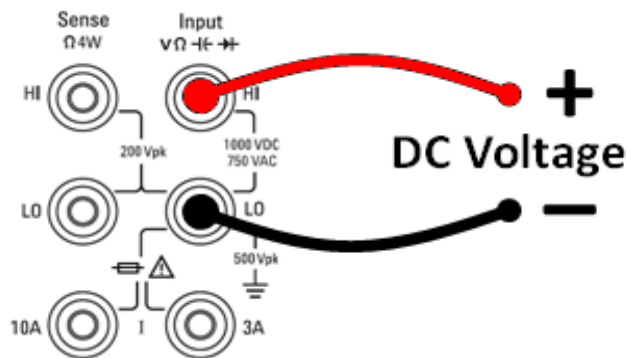

Step 2: Press **[Acquire]** on the front panel to display these softkeys:



Press the **Acquire** softkey.



Press the **Data Log** softkey. The Data Log menu opens:



Step 3: Press **Sample Interval** and specify the time interval between samples (readings).

Note: You may see this message when configuring data logging: *Sample interval is limited by measurement settings*. The measurement time is determined by the measurement function, NPLC, Aperture,

Autorange, Autozero, Offset Compensation, AC Filter, TC Open Check, and Gate Time. The data logging Sample Interval cannot be less than the measurement time. You can shorten the measurement time by selecting less integration time, selecting a fixed range, and so on.



Step 4: Press the **Duration** softkey to specify the length of time to log data, or, press **Duration** again to specify the total number of readings to log.

Step 5: Press **Start** to specify when to start data logging. You can select:

- **Start Delay** - Starts data logging after a specified time delay. Specified in HH.MM.SS format.
- **Start Time of Day** - Starts data logging at a specified time of day. Specified in HH.MM.SS format. Using the time of day requires that the instrument's real-time clock is properly set. To set the clock, press **[Shift]** > **[Utility]** > **System Setup** > **Date/Time**.



NOTE You cannot configure a trigger source when data logging. You can only use auto trigger (selected by default) or, when ready to initiate data logging, you can cause a single trigger (by pressing **[Single]**). The effect is the same, as you only need one auto trigger or single trigger event to enable data logging.

Step 6: Press **Log To** > **Log To Memory** or **Log To Files** to specify whether the data logging results will be stored in volatile memory for display or written to one or more internal/external files.

- When data logging to memory, the data is volatile (not remaining during power off) but can be saved to an internal or external file after data logging is complete (see Step 7 below). The number of readings you can store in memory depends on the amount of instrument memory. With the MEM option, the limit is 2,000,000 readings. Without the MEM option, the limit is 50,000 readings.

- When data logging to file(s), **Browse** to an internal or external path and specify a **File Name**. If more than one file needs to be created to hold the data, the second file name will be appended with _00001, the third file name with _00002, and so on. When data logging to files, the maximum number of readings is 360,000,000.

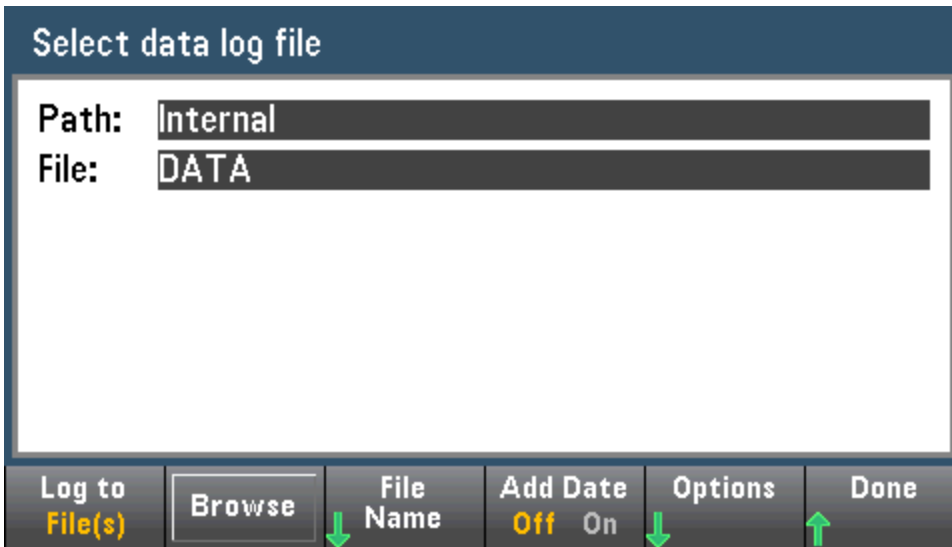

When **Add Date** is **On**, the data logging start date and time is appended to the file name using the format:

_YYYYMMDD_HHMMSS

For example, for a file named *Data 1*, the result will be similar to: *Data 1_20140720_032542*.

Press **Options** to to configure reading storage options:



Rows/File - Specifies the maximum number of rows or readings to be written to a file. For **Max**, the limit is the number of bytes allowed by the file system ($2^{32} = 4.294967296$ GBytes). This represents approximately 252 M readings with Metadata Off, or 159 M readings with Metadata On. For **1M**, the limit is 1,000,000 rows in the resulting file. This allows you to accommodate common spreadsheet, database and data analysis programs that have limitations of 1 million rows per file.

Metadata - Enables reading number, time stamp of first reading, and sample interval (if available) in the file.

Separator - Specifies the character (Comma, Tab, or Semicolon) to use for separating the information on each row.

When finished configuring reading storage, press **Done** > **Done** to return to the main data logging menu.

Step 7: Press **[Run/Stop]** or **[Single]**. Data logging starts when the specified delay has elapsed or the time of day occurs (specified in Step 5). Data logging will stop after the specified duration (time or number of readings) has occurred or after you press **[Run/Stop]** again.

When data logging is complete:

- When data logging to file(s), the instrument saves the file(s) with the specified name and path.
- When data logging to memory, you can now save the readings from the main data log menu by pressing **Save Readings**.



You can then **Browse** to an internal or external path and specify a **File Name**. You can also specify reading storage **Options** as described above in Step 6.



Trend Chart for Data Logging

The Trend Chart is particularly useful for viewing data logging measurements. See [Trend Chart \(Digitize and Data Log Modes\)](#) for details.

Digitizing

The digitizing feature (applies only to the 34465A/70A with the DIG option) provides a front-panel user interface that allows you to quickly set up digitized measurements. Digitizing is the process of converting a continuous analog signal, such as a sine wave, into a series of discrete samples (readings):

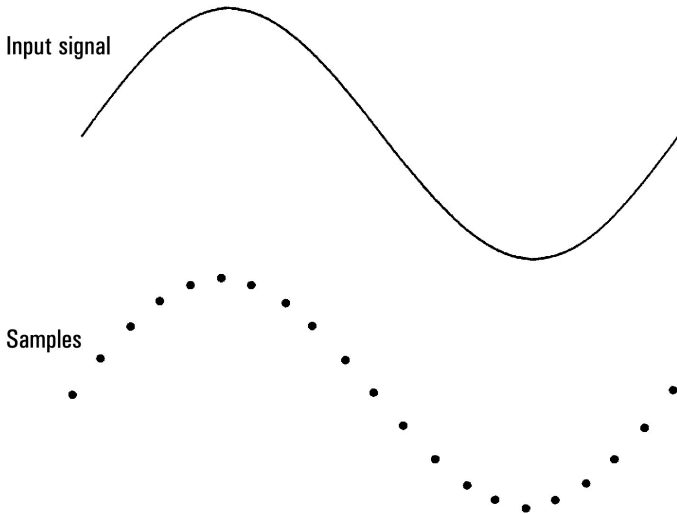

See [Digitizing Measurements](#) for a tutorial on digitizing and more information on samples rates vs. input frequencies.

The DMM digitizes by sampling the input signal using either the DCV function (default) or the DCI function with autorange and autozero disabled.

CAUTION

Loss of data possible - local to remote transition clears instrument memory: When data logging or digitizing *to memory*, if you access the instrument from remote (send a SCPI or common command)* and then return to local (by pressing **[Local]**), the readings in memory are cleared and the instrument returns to Continuous mode.

For data logging only, you can prevent this situation by data logging to a file instead of to memory (see [Data Log Mode](#) for details). You can also prevent this from happening for data logging or digitizing by taking steps to keep the instrument from being accessed from remote. To prevent remote access, you may want to disconnect the LAN, GPIB, and USB interface cables from the instrument before starting the measurements. To prevent remote access via LAN, you can connect the instrument behind a router to minimize the possibility of remote access. You can also disable the various I/O interfaces from the front panel menus under **[Utility] > I/O Config**.

To view the status of a data logging or digitizing operation remotely, use the instrument's [Web User Interface](#). The Web User Interface monitor does not set the instrument to remote.

**When accessed from remote, the instrument will continue data logging or digitizing to completion, and you can retrieve the readings from remote.*

Digitizing Overview

This section is a summary of the steps involved in setting up digitizing. Detailed steps are described below in Detailed Digitizing Steps.

1. Select DCV or DCI measurements and connect to the DUT.
2. Select Digitize mode (press **[Acquire]** > **Acquire** > **Digitize**).
3. Specify the sample rate (for example, 50 kHz) or sample interval (for example, 20 μ S).
4. Specify the duration as amount of time or number of readings.
5. Select trigger source (Auto, Ext, or Level).
 - a. For external, specify polarity.
 - b. For level, use Range +/- to select fixed range, then specify threshold and polarity.
6. Specify delay time or use auto.
7. Optional: If using the level or external trigger source, specify a pretrigger count (number of readings to store before the trigger event occurs).
8. Press **[Run/Stop]**. Digitizing starts when the trigger event occurs and stops after duration or when you press **[Run/Stop]** again.
9. Save the digitized data to a file.
10. Optional: select trend chart to view digitized data.

NOTE The histogram and statistics functions can be used when digitizing. However, this data will not be updated until digitizing is complete.

Detailed Digitizing Steps

Step 1: To digitize DC voltage, press **DCV** and configure the test leads as shown.

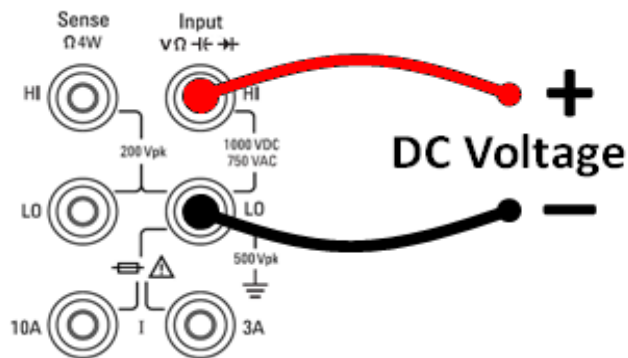

To digitize DC current, press **DCI** and configure the test leads as shown.

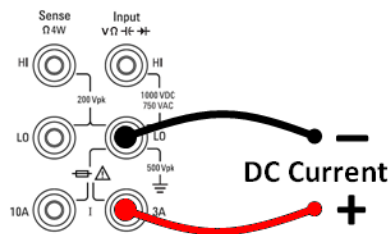

On the 34461A/65A/70A, you can also configure the measurement using the 10 A terminal, which is recommended when measuring current above 1 A:

Features and Functions

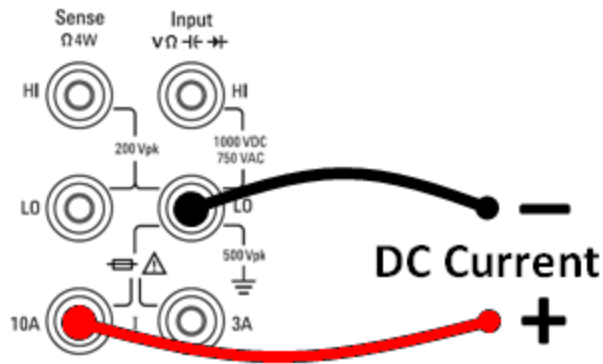

Step 2: Press [Acquire] on the front panel and then press the **Acquire** softkey:



Press the **Digitize** softkey:



Step 3: The Digitize menu opens:



With **Sample Rate** selected, use the up/down arrow keys to select a sample rate in samples per second (Hz), or press the **Sample Rate** softkey to specify a sample interval (time between samples):



Step 4: Press the **Duration** softkey to specify the length of time to digitize:



or, press **Duration** again to specify the total number of samples to digitize:



Step 5: Press **Trigger Settings** to view or change the trigger source. By default, the trigger source is set to auto. You can also select external and level triggering when digitizing.

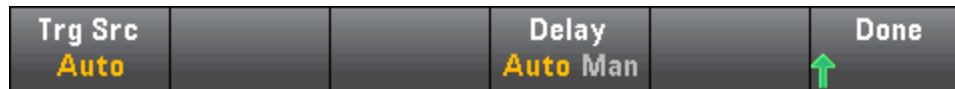

Press **Trg Source** and select one of three trigger sources:



Auto - the instrument automatically triggers immediately after you press **[Run/Stop]** or **[Single]**.

Step 5a Configure external triggering: After pressing **Ext**, this menu appears:



Ext - the instrument triggers when an edge of the appropriate slope arrives at the rear-panel Ext Trig connector. You can specify the slope on the softkey menu that appears when **Trg Src** is set to Ext. To select external triggering, press **Ext**, and select either Pos or Neg slope:

Step 5b Select level trigger: Level - (34465A/70A with DIG option only) the instrument issues one trigger when the specified measurement threshold with the specified positive or negative slope occurs. To select level triggering, press **Level** and specify the level threshold and Pos or Neg slope:

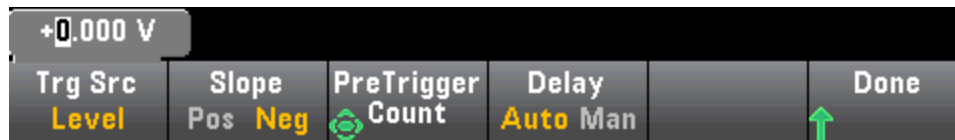

NOTE Select the expected measurement range using the **[Range]** **[+]** and **[-]** keys before setting the level trigger voltage or current.

Step 6: Specify delay time

Specify the delay that occurs prior to digitizing. This delay is inserted once, after the trigger event occurs, and before digitizing begins. This can be automatic (the instrument chooses the delay based on the instrument's settling time) or manual (you specify the delay time).

Step 7: (Optional) Specify pretrigger count.

When an External or Level Trigger Source is used, you can specify a pretrigger count. After specifying a pretrigger count, readings are taken and held in a buffer while waiting for the trigger event to occur. When the trigger event occurs, the buffered readings are transferred to reading memory and the remaining readings are recorded as usual. If the trigger event occurs before Pretrigger Count readings have been taken, the trigger event will still take effect and digitizing will complete without having taken all of the pretrigger readings. The Pretrigger Count is limited to one less than the total number of readings specified to be taken by the Duration setting.

Step 8: Press [Run/Stop] to start the digitizing process. Digitizing will begin when the specified trigger event occurs and after the specified delay has elapsed. - **Digitizing** is displayed at the top of the display while digitizing; when finished, **Digitize Stopped** is displayed.

Step 9: All readings taken during digitizing are saved in volatile memory, when digitizing is finished, press the **Save Readings** softkey to specify a file location and save the readings.

Step 10: (Optional) Press **Display > Display Trend** to view the trend chart. The Trend Chart is particularly useful for viewing and analyzing digitized measurements. X and Y cursors (shown below), tracking cursors, pan control, and zoom allow you to analyze digitized data. See [Trend Chart \(Digitize and Data Log Modes\)](#) for details.

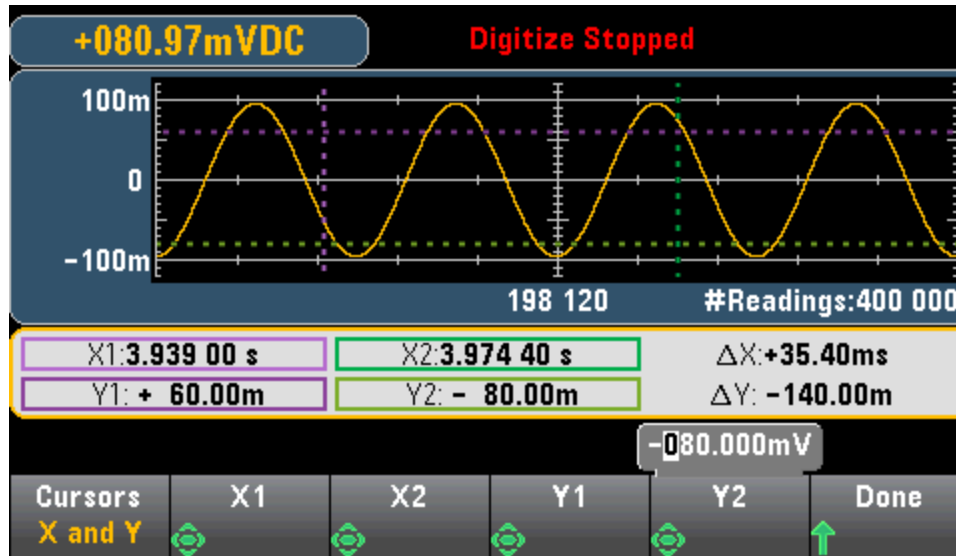

Sunday, August 31, 2014 - 04:08

Level Triggering

Level triggering is available only on the 34465A/70A with the DIG option. Level triggering allows you to trigger measurements at some defined point on the input signal, such as when the signal crosses zero volts or when it reaches the midpoint of its positive or negative peak amplitude. For example, this graphic shows sampling beginning as the input signal crosses 0V with a positive slope:

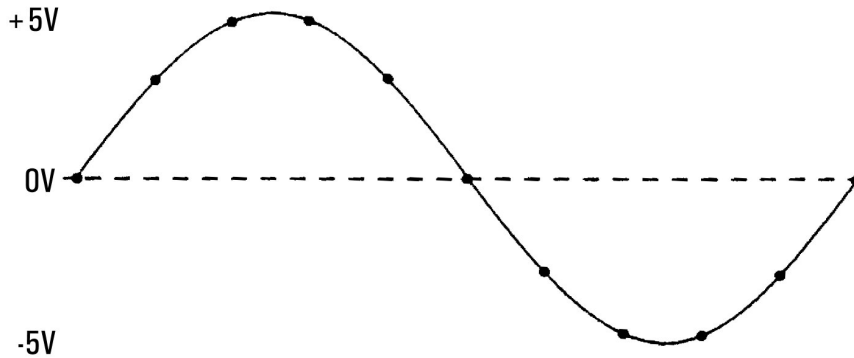

About Level Trigger

Level triggering is available for these measurement functions:

- DC voltage and DC current
- AC voltage and AC current
- 2-wire and 4-wire resistance with offset compensation off, and low power off
- Temperature, RTD or thermistor sensors only
- Frequency and period

The level trigger is edge-sensitive. That is, the instrument must detect a *change* in the quantity being measured from one side of the level setting to the other side (direction controlled by Slope setting). For example, if the Slope is positive, then the quantity being measured must first reach a value *below* the set level before a trigger event can be detected.

Level trigger performance is not uniform. Its accuracy, latency, and sensitivity are dependent on other DMM features. These dependencies vary by measurement function as described below.

DC voltage, DC current, and 2-wire resistance considerations

These measurement functions can use a fast-response detector built into the hardware for fixed-range measurements. For lowest latency and highest sensitivity, use a fixed range when using level trigger. However, trigger level accuracy is reduced when the hardware detector is used.

To increase trigger level accuracy and reduce sensitivity (avoid false triggers due to noise), use autorange:

Features and Functions

- When auto-range is enabled, trigger level accuracy is increased, latency is increased, and sensitivity is decreased as the aperture or NPLC setting is increased.
- When auto-range is enabled, trigger level accuracy is increased, latency is increased, and sensitivity is decreased if autozero is enabled.
- When auto-range is enabled, range changes may be made while waiting for the trigger crossing which can cause additional latency/uncertainty.

4-wire resistance and temperature considerations

- Trigger level accuracy is increased, latency is increased, and sensitivity is decreased as aperture or NPLC is increased.
- Fixed range (only available for resistance) eliminates uncertainties (due to range change) in trigger latency.

AC voltage and AC current considerations

- Trigger latency is increased, and sensitivity is decreased as filter bandwidth is increased.
- Trigger latency can be controlled by trigger delay setting.
- Fixed range eliminates uncertainties (due to range change) in trigger latency.
- Autorange uncertainties become worse as filter bandwidth is increased.

Frequency and period considerations

- Trigger level accuracy is increased, latency is increased, and sensitivity is decreased as gate time is increased.
- Fixed voltage range eliminates uncertainties (due to range change) in trigger latency.

Secondary Measurements

Most measurement functions allow you to select and display a secondary measurement function. Secondary measurements can be displayed in the Number and Bar Meter displays only. For example, a thermistor temperature measurement (primary) and the resistance measurement made on the thermistor (secondary) are shown below:

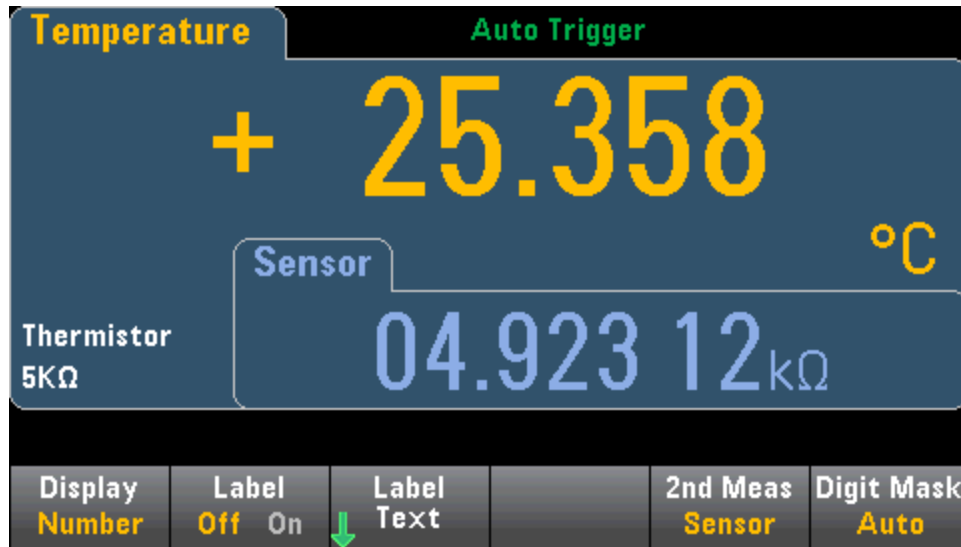

To select a secondary measurement from the front panel, first select the primary measurement function and then press **Display**:



Press **2nd Meas** and select the secondary measurement.

The primary measurement functions and their associated secondary measurements for each DMM model are:

Primary Measurement Function	34460A/61A Secondary Measurement Function	34465A/70A Secondary Measurement Function
DCV	ACV ¹	ACV ¹ , Peak, Pre-Math
ACV	Frequency	DCV ¹ , Frequency, Pre-Math
2-Wire, 4-Wire Resistance		Pre-Math
DCI	ACI ¹	ACI ¹ , Peak, Pre-Math
ACI	Frequency	DCI ¹ , Frequency, Pre-Math
Frequency	Period	Period, ACV, Pre-Math
Period	Frequency	Frequency, ACV, Pre-Math
Temperature	Sensor	Sensor, Pre-Math
Ratio	Input/Ref	Input/Ref, Pre-Math
Capacitance		Pre-Math
Cont		None
Diode		None

Features and Functions

Where:

- Pre-Math - The measurement value before any math operations are done (including NULL).
- Sensor - The raw sensor value; ohms for thermistor/RTD, volts for thermocouple (thermocouple measurements apply to the 34465A and 34470A only).
- Input/Ref - The DC signal voltage and the DC reference voltage measurements.
- Peak - Displays a running history of the minimum peak, maximum peak, and peak-to-peak values of the input signal. Peak measurements are high-speed (16 μ s effective aperture) and are different from the Min, Max, and Peak-to-Peak values gathered in Statistics.

¹ After making one or more primary measurements for approximately 4 seconds, the DMM makes one secondary measurement.

For the Peak secondary measurement, the **Clear Peaks** softkey allows you to clear the accumulated history of the peak-to-peak function (resets the record of peak values).

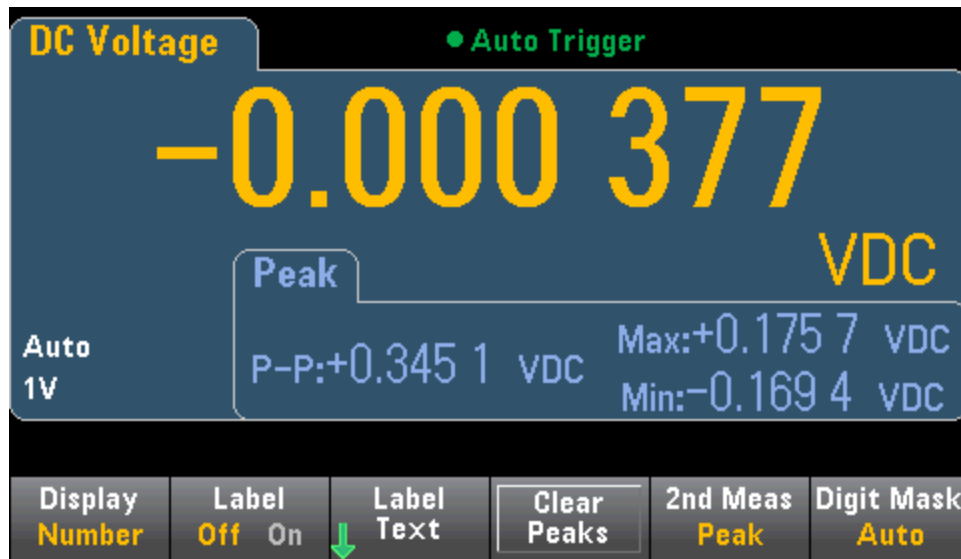

Triggering and Readings

The trigger model and large reading memory on the Truevolt Series DMMs provide versatile capabilities for a wide variety of applications.

Instrument trigger model

Acquiring measurements on the DMM is done as the result of triggering. This section describes how to configure triggering for the Continuous measurement mode. For the 34465A/70A, refer to [Digitizing](#) and [Data Logging](#) for information on triggering in those measurement modes.

For the 34460A/61A, pressing **[Acquire]** opens the following menu:



For the 34465A/70A, pressing **[Acquire]** opens the following menu:



Press **Trigger Settings** to open the following menu:



The menus above allow you to configure measurement triggering, and you can also use the **VMC Out** softkey to set the edge slope of the **VM Comp** (voltmeter complete) output on the instrument's rear panel. This connector issues a signal whenever the voltmeter finishes taking a measurement to allow you to signal other devices in a measurement system.

NOTE For accurate displayed statistics of AC measurements in Front Panel mode, the default manual trigger delay (**[Acquire]** > **Delay Man**) must be used.

The **(Trg Src)** menu allows you to select one of these trigger sources:



Auto - the instrument continuously takes measurements, automatically issuing a new trigger as soon as a measurement is completed.

Single - the instrument issues one trigger each time the front panel **[Single]** key is pressed.

Ext - (Ext requires LAN option on 34460A) the instrument issues one trigger each time an edge of the appropriate slope arrives at the rear-panel Ext Trig connector. You can specify the slope on the softkey menu that appears when **Trg Src** is set to Ext.

Level - (34465A/70A with DIG option only) the instrument issues one trigger when the specified measurement threshold with the specified positive or negative slope occurs.

In the Single, Ext, and Level modes, you can specify the number of samples to be taken per trigger by using the **Samples/Trigger** softkey. The Single and Ext modes can both buffer up to one trigger, meaning that if you press [**Single**] or receive an external trigger while a series of measurements is in progress, the instrument will finish that series of measurements and then immediately launch a new series of measurements based on the trigger.

If multiple [**Single**] or external triggers are issued during a series of measurements, all triggers received after the first are discarded.

The [**Acquire**] menu also configures the delay that occurs before each measurement is taken, regardless of the trigger mode (Auto, Single, or Ext). This may be either automatic (the delay is based on the DMM's settling time) or manual (you specify the delay time).

Finally, note the [**Run/Stop**] and [**Single**] keys on the front panel. In Auto trigger mode, pressing [**Run/Stop**] stops and resumes measurements, and pressing [**Single**] switches the instrument to single trigger mode. In the Single and Ext modes, pressing [**Run/Stop**] stops readings if they are in progress, or switches the mode to Auto if readings are stopped.

Trigger delay and multiple samples

The instrument inserts a trigger delay between the occurrence of a trigger and the first measurement. When **Auto** is used (**Delay Auto** softkey), the instrument automatically determines the delay based on function, range and integration time. See [Automatic Trigger Delays](#) for further information. However, you may need to manually set a delay (**Delay Man** softkey) longer than the automatic delay to allow the input to settle before pacing a burst of measurements, for measurements with long cables, or for measurements of high capacitance or high impedance signals.

If you have configured the instrument for more than one sample per trigger (**Samples/Trigger** softkey), in all cases, the first sample is taken one trigger delay time after the trigger occurs. Beyond that, sample timing depends on whether you select immediate (**Sample Immediate** softkey, default) or timer (**Sample Timer** softkey) as described below.

- **Sample Immediate** - The first sample starts one trigger delay time after the trigger, and then the trigger delay time is inserted between successive samples:

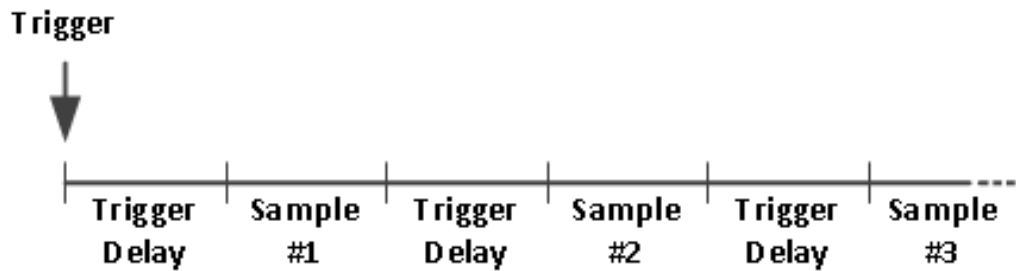

In this configuration, the sample timing *is not* deterministic because the delay time is inserted after each sample completes. The actual time required to take each sample depends on the integration time and autoranging time.

- **Sample Timer** - The first sample starts one trigger delay time after the trigger. The second sample starts one sample interval after the start of the first sample, and so on:

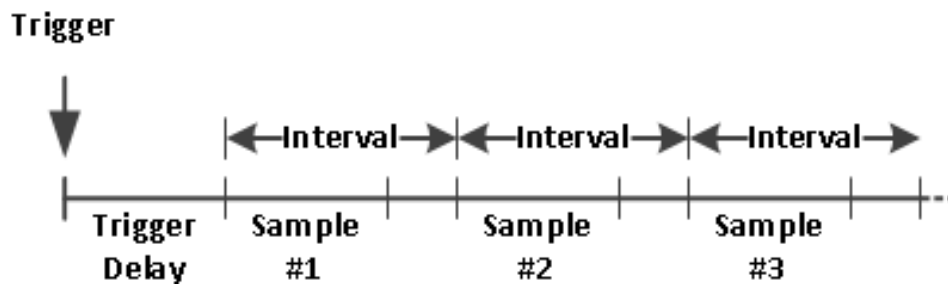

In this configuration, the sample timing *is* deterministic because the start of each sample is determined by the specified sample interval (the trigger delay affects only the start of the first sample). Integration time and autoranging affect the sampling time for each sample, but not the sample interval. Periodic sampling continues until the sample count (set with the **Samples/Trig** softkey) is satisfied.

NOTE From the front panel, the instrument prevents you from specifying a sample timer that is shorter than the time required to make measurements based on the present function, range, and integration time.

Storing and clearing readings

You can store up to 1,000 measurements in the reading memory of the 34460A, 10,000 measurements on the 34461A, 50,000 measurements on the 34465A/70A (*without* the MEM option), or 2,000,000 measurements on the 34465A/70A (*with* the MEM option). Readings are stored in a first-in, first-out (FIFO) buffer; when reading memory is full, the oldest readings are lost as newer readings are taken.

In Local (front panel) mode, the instrument collects readings, statistics, trend chart and histogram information in the background, so if you select any of those options, the data is ready for viewing. In Remote (SCPI) mode, the instrument does not collect this information by default.

Changing the instrument from Local to Remote does NOT clear any readings in memory. Changing the instrument from Remote to Local DOES clear any readings in memory.

In general, you turn the reading of measurements on and off by pressing **[Run/Stop]**, as described above. You can also take one reading or a specified number of readings by pressing **[Single]**.

To save readings, press **[Acquire] > Save Readings**. Then use the menu that appears to configure the location where you want to save the readings:



See [Utility Menu - Manage Files](#) for details.

For the 34460A/61A only, press **Save Readings** to save the readings in memory to a file.

For the 34465A/70A only, press **Options** to configure reading storage options:



Rows/File - Specifies the maximum number of rows or readings to be written to a file.

- For **Max**, the limit is the number of bytes allowed by the file system ($2^{32} = 4.294967296$ GBytes). This represents approximately 252 M readings with Metadata Off, or 159 M readings with Metadata On.
- For **1M**, the limit is 1,000,000 rows in the resulting file. This allows you to accommodate common spreadsheet, database and data analysis programs that have limitations of 1 million rows per file.

Metadata - Enables reading number, time stamp of first reading, and sample interval (if available) in the file.

Separator - Specifies the character (Comma, Tab, or Semicolon) to use for separating the information on each row.

When finished configuring reading storage, press **Done > Save Readings** to save the readings in memory to a file.

Clearing Reading Memory

The following actions clear reading memory:

- Changing the measurement function
- Pressing any **Clear Readings** softkey
- Transitioning in or out of Probe Hold
- Changing temperature units
- Changing any dB/dBm parameters
- Changing any histogram binning parameter
- Changing the temperature probe or R_0
- Recalling a stored state
- Calibrating the instrument
- Switching between 3 A and 10 A inputs
- Changing the position of the Front/Rear switch
- Transferring from Remote to Local mode
- Turning Null on or off or changing the Null value

These actions do not clear reading memory:

- Changing measurement parameters, such as range and aperture.
- Turning limits on or off, or adjusting limit values
- Pressing **[Run/Stop]** in front panel auto trigger mode
- Changing the trend chart **Recent/All** softkey (34461A/65A/70A only)
- Changing samples per trigger or trigger delay
- Changing display modes
- Changing the **VM Comp** output polarity
- Changing the digit mask
- Changing the histogram, bar meter, or trend chart scale
- Changing user preferences
- Executing self-test

Probe Hold

Because probing small areas requires careful concentration, it is often difficult to read the instrument display while taking measurements. Therefore, the instrument includes a front panel **[Probe Hold]** key that allows you to take readings without viewing the display. You can generate up to eight readings and hold them on the display for later viewing. These readings may be of different measurement types and you may clear displayed readings at any time.

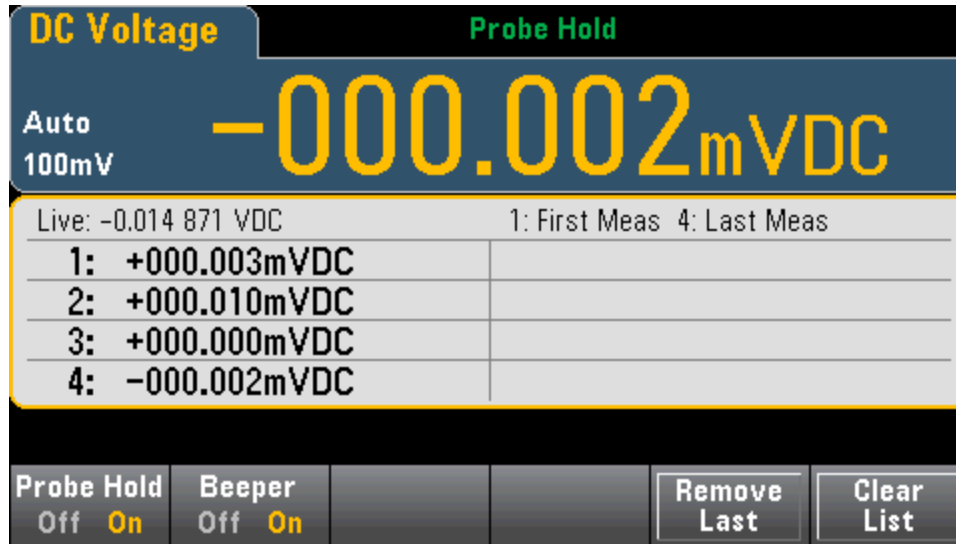

In Probe Hold mode, the instrument optimizes measurement settings to allow reliable detection of stable signals (these settings are restored to their original values when you exit Probe Hold.) When you probe a signal, the instrument beeps (if the beeper is enabled) and automatically records a measurement when it finds a series of stable readings. You may take additional readings without pressing **[Probe Hold]** again.

Press **Remove Last** to remove the last reading from the list. Press **Clear List** to remove all readings from the list.

Because the Probe Hold display is optimized for the Probe Hold readings, you may not combine it with other display modes, such as histogram, bar graph, trend chart, or statistics.

Probe Hold is a front panel only function. Readings recorded in Probe Hold mode cannot be accessed from remote. You can, however, take a screen capture of the probe hold display, see [Utility Menu - Manage Files](#) for details.

Math - Introduction

The **[Math]** key is the shifted **[Null]**:



These math functions are available for the 34460A/61A:

DCV Null	dB / dBm	Statistics	Limits		
Off Value	↓	↓	↓		

- Null
- dB/dBm Scaling
- Statistics
- Limits

These math functions are available for the 34465A/70A:

DCV Null	Smoothing	Scaling	Statistics	Limits	
Off Value	↓ Filter	↓	↓	↓	

- Null
- Smoothing Filter
- Scaling
- Statistics
- Limits

Math - Null

A null reading is a value that is subtracted from all subsequent measurements. The value is specific to the present function and will persist even if you leave this function and return to it later.

One common use of this feature is to remove lead resistance from a resistance measurement. To do this, simply short the test leads together and press **[Null]**. For other measurement functions, place the probes across a null value circuit before pressing **[Null]**.

You can also specify a null value by pressing **[Math]**, changing the first softkey to **Value**, and entering the value using the arrow keys. To turn off the null feature, press **[Null]** again or press **[Math]** and set the first softkey to **Off**.



See Also

[Math - Introduction](#)

[dB/dBm Scaling](#)

[Statistics](#)

[Limits](#)

Math - dB/dBm Scaling

NOTE

This topic describes dB/dBm Scaling for the 34460A/61A. Scaling features are different for the 34465A/70A and are described in the [Scaling](#) topic.

The dB and dBm scaling functions, which apply to ACV and DCV measurements only, allow you to scale measurements relative to a reference value.

NOTE

Scaling is set to OFF when you change measurement functions (for example, changing from DCV to ACV). You must re-enable scaling after changing measurement functions.

Front Panel Menus

The dB and dBm functions are accessed from the second softkey in the **[Math]** menu.



When the first softkey in the dB / dBm menu is enabled, as shown below, you will see one of the following menus:

When function is dB:



When function is dBm:



dB Scaling

Each dB measurement is the difference between the input signal and a stored reference value, with both values converted to dBm:

$$\text{dB} = \text{reading in dBm} - \text{reference value in dBm}$$

The relative value must be from -200 to +200 dBm (default 0). You can either measure this value by pressing **Measure Ref Value**, or you can enter a specified value.

dBm Scaling

The dBm function is logarithmic, comparing power delivered to a reference resistance, relative to 1 milliwatt:

$$\text{dBm} = 10 \times \log_{10} (\text{reading}^2 / \text{reference resistance} / 1 \text{ mW})$$

The reference resistance value (**Ref R**) may be 50, 75, 93, 110, 124, 125, 135, 150, 250, 300, 500, 600 (default), 800, 900, 1000, 1200, or 8000 Ω . Press **Ref R** and use the front panel up and down arrows to make your selection.

See Also

[Math - Introduction](#)

[Null](#)

[Statistics](#)

[Limits](#)

Math - Scaling

NOTE

This topic describes dB/dBm Scaling for the 34465A/70A. Scaling features are different for the 34460A/61A and are described in the [dB dBm Scaling Menu](#) topic.

Press the **Scaling** softkey to open the default dB scaling menu:



Press the **Function** softkey to select a scaling function:

NOTE

Scaling is set to OFF when you change measurement functions (for example, changing from DCV to ACV). You must re-enable scaling after changing measurement functions.

dB Scaling

Each dB measurement is the difference between the input signal and a stored reference value, with both values converted to dBm:

$$\text{dB} = \text{reading in dBm} - \text{reference value in dBm}$$

The relative value must be from -200 to +200 dBm (default 0). You can either measure this value by pressing **Measure Ref Value**, or you can use the **dB Ref Value** softkey to specify a value.

dB scaling applies to ACV and DCV measurements only.

dBm Scaling



The dBm function is logarithmic, comparing power delivered to a reference resistance, relative to 1 milliwatt:

$$\text{dBm} = 10 \times \log_{10} (\text{reading}^2 / \text{reference resistance} / 1 \text{ mW})$$

The reference resistance value (**Ref R**) may be 50, 75, 93, 110, 124, 125, 135, 150, 250, 300, 500, 600 (default), 800, 900, 1000, 1200, or 8000 Ω. Press **Ref R** and use the front panel up and down arrows to make your selection.

dBm scaling applies to ACV and DCV measurements only.

% Scaling



% performs a percent change operation. The result is the percent change of the measurement from the reference value:

$$\text{Result} = ((\text{Measurement} - \text{Reference}) / \text{Reference}) * 100.$$

Press **Measure Reference** to use the first measurement as the reference value, or press **Ref Value** to specify the reference value.

% scaling applies to all measurement functions except Ratio, Continuity, and Diode.

Mx-B Scaling



For Mx-B scaling, the result is the measurement multiplied by the **Gain (M)** value minus the **Offset (B)** value.

The **User Units** softkey allows you to specify the custom alphanumeric label of up to four characters (for example, RPM or °C) for Mx-B scaled measurements.

Mx-B scaling applies to all measurement functions except Ratio, Continuity, and Diode.

See Also

[Math - Introduction](#)

[Null](#)

[Statistics](#)

[Limits](#)

Math - Smoothing

(34465A/70A only) Smoothing uses a moving average (boxcar) filter to reduce random noise in measurements. Smoothing is intended to average out small variations in the measurements. Larger variations will cause the filter to reset.

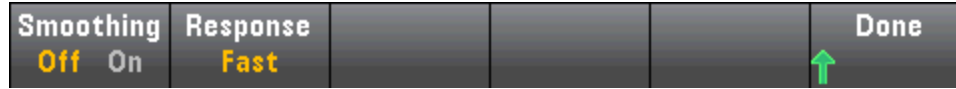

Press **Response** to select **Slow** (100 readings), **Medium** (50 readings), or **Fast** (10 readings) to average.



The smoothing filter applies to all measurement functions except Digitizing, Data Logging, Continuity, Diode, and Probe Hold.

The smoothing filter starts out from a reset condition (no readings in the filter) and is reset if the measurement function is changed or if a reading is too far beyond the current average. After the filter is reset, the reading is the average of all readings up to the specified response (10, 50, 100). At that point, the reading is the moving average of the last 10 (Fast), 50 (Medium), or 100 (Slow) readings. Equal weighting is applied to all readings in the average.

The **Filter** icon (top, right-side of the display) indicates the variation of readings, the amount of allowable readings in the filter, and when the filter is reset as follows:

- Too great of reading variation will constantly reset the filter and the filter icon will be solid yellow (**Filter**).
- As the filter fills with readings, that are within the allowable variation from the readings already in the filter, the filter icon will turn green progressively from left to right (**Filter** -> **Filter**).
- A single reading, that is beyond the allowable variation from the readings in the filter, will reset the filter and set the filter icon to solid yellow (**Filter**).
- If all readings are within the allowable variation from the readings in the filter, the filter icon will be solid green (**filter**).

Math - Statistics

As the instrument takes measurements, it automatically calculates statistics on those measurements.

Front Panel Menus

The statistics menu is accessed from the third softkey in the **[Math]** menu.



NOTE For accurate displayed statistics of AC measurements in Front Panel mode, the default manual trigger delay (**[Acquire] > Delay Man**) must be used.

The first softkey on this menu (shown below) hides or shows the statistics below the data display (number, bar meter, trend chart (not available on the 34460A), or histogram).

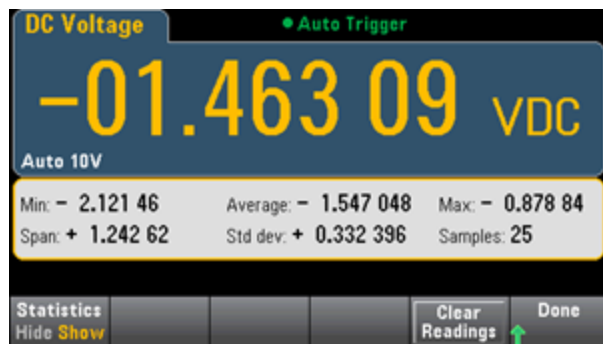

The average and standard deviation are not shown if dB or dBm scaling is in use.

Remarks

- The **Span** value is the **Max** minus the **Min**.
- Press **Clear Readings** to clear reading memory and re-start statistics calculation.

See Also

[Math - Introduction](#)

[Null](#)

[dB/dBm Scaling](#)

[Limits](#)

Math - Limits

Limit checking indicates how many samples have exceeded specified limits and visually indicates when the limits are exceeded.

Front Panel Menus

The limits menu is accessed from the **[Math]** menu.

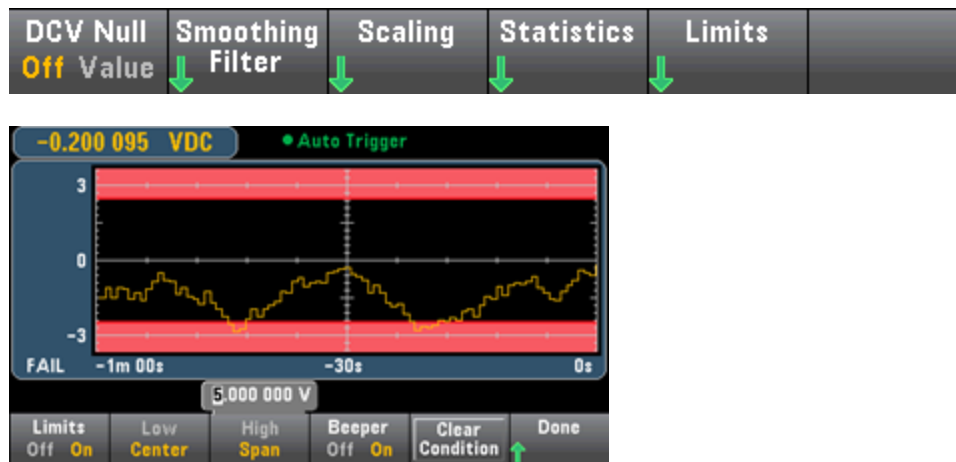

The first softkey enables or disables limits. The second and third softkeys specify the limits either as high and low values or as a span around a center value. For example, a **Low** limit of -4 V and a **High** limit of +7 V are equivalent to a **Center** of 1.5 V and a **Span** of 11 V.

The **Beeper** softkey enables or disables beeping when limits are violated (this also enables or disables the beeper for the other functions that use the beeper - probe hold, diode, continuity, and errors). **Clear Condition** resets the limit borders to green, as described below.

Limit Indications

The display uses colors to indicate limits and limit violations.

Trend Chart (34461A/65A/70A only)

The limit area is shown in light red on the graph. The limit borders are green (shown below) as long as the limits have not been exceeded.

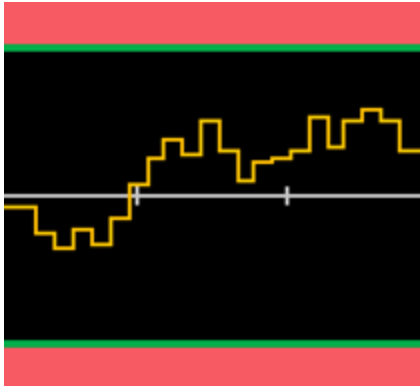

When a limit is exceeded, the border turns red. In the image below, the top border is still green, but the bottom border has changed to red because the trend line has gone into the lower limit area.

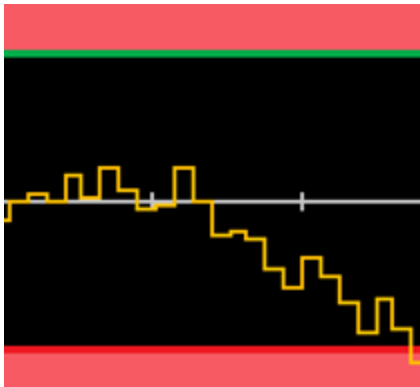

The border will remain red even if the trend line moves out of the limit area. When the trend line is within limits, you can reset the borders to green by pressing **Clear Condition**.

Note also that the number of the newest displayed measurement, +09.994 VDC below, indicates whether the measurement is within limits. Because the limit is 10 V, the 9.994 VDC value is shown with the standard background.

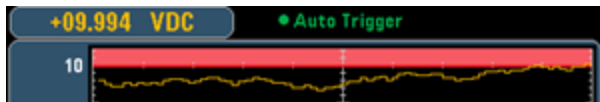

In contrast, the 11.083 VDC reading is highlighted in red to indicate that it is outside the limits.

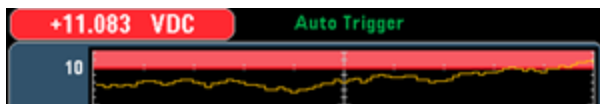

Features and Functions

Histogram

The same color scheme applies to histograms. In the image below, the green vertical lines that separate the black histogram background from the light red limit areas indicate that limits have not been exceeded.

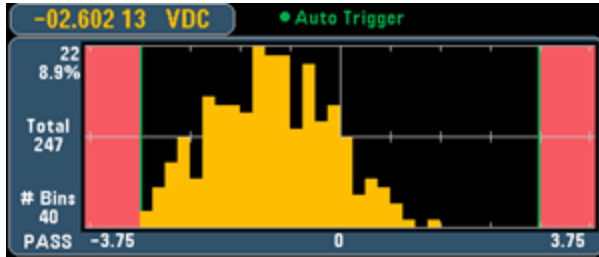

In the image below, the lower (left) limit border is red, indicating that the lower limit has been exceeded. (The reading in the upper left corner (-01.68487 VDC) is within limits, so it is not red.)

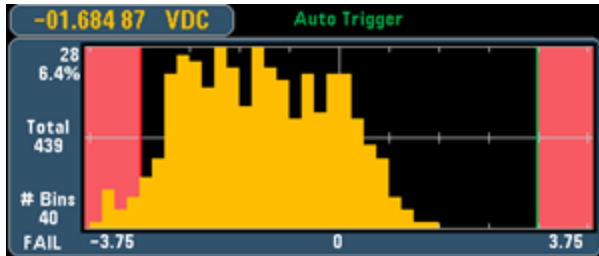

Bar Meter

The bar meter (below) uses the same color scheme. The green limit border on the left indicates that the lower limit has not been exceeded, and the red limit border on the right indicates that the upper limit has been exceeded. The numbers 0 and 259 below the light red limit areas indicate how many times each limit has been exceeded, and the word **FAIL** indicates that a limit has been exceeded.

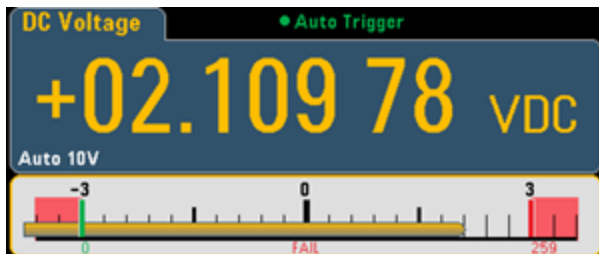

Number

The bright red color (shown below) indicates that the displayed measurement exceeds the limits. The **Number** display also indicates how many times the limits have been exceeded.

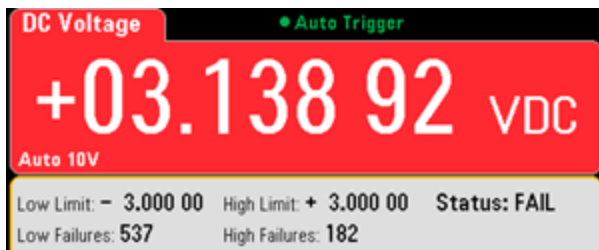

See Also

[Math - Introduction](#)

[Null](#)

[dB/dBm Scaling](#)

[Statistics](#)

Display - Introduction

By default, the instrument displays readings as a number. You can also select a Bar Meter, Trend Chart (34461A/65A/70A only), or Histogram display:



For the Number and Bar Meter displays, many primary measurement functions allow you to display a secondary measurement. See [Secondary Measurements](#) for details.

Selecting the Display

Pressing the **Utility** **Display** key, followed by the **Display** softkey allows you to select the display type:



The following table summarizes the various instrument display types for each measurement mode.

Mode	Display Type				Comments/Uses
	Number	Bar Meter	Trend Chart	Histogram	
Continuous	Power-on default, present measurement on display.	Number + bar graph, present measurement on display.	Measurements spanning a specified amount of time, and displayed as strip chart (Trend), or histogram. Exact measurement values not accessible from front panel.		Trend and Histogram data is display only, individual reading values not available from front panel.
Data Log	Present reading on display. All other points stored as specified in Acquire menus. Remaining time and remaining samples displayed near bottom.		Chart or Graph populated as samples taken. Zoom, pan and cursors available to facilitate individual measurement viewing.		Standard on the 34465A and 34470A only. See Data Log Mode for details.
Digitize	Present reading on display. All other points stored as specified in Acquire menus. Remaining time and remaining samples displayed near bottom.		Chart or Graph populated as samples taken. Zoom, pan and cursors available to facilitate individual measurement viewing.		34465A and 34470A only, requires DIG option. Optimized for high speed sampling. Max sample interval 100 ms, min 20 μ s. See Digitize Mode for details.

Click a link below for more information on any of the display types:

[Number](#)

[Bar Meter](#)

[Trend Chart \(34461A/65A/70A only\)](#)

[Histogram](#)

[Secondary Measurements](#)

Number

By default, the instrument displays readings as a number:

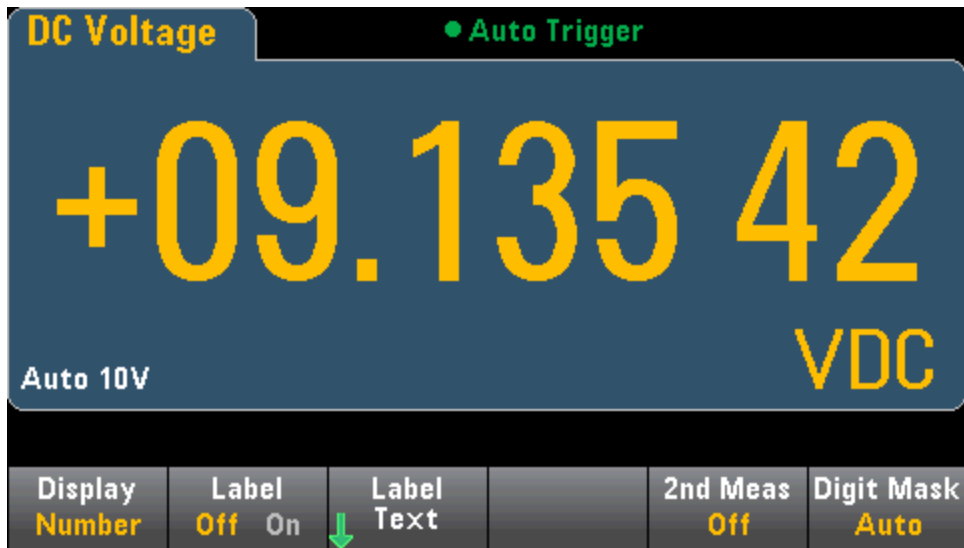

Adding a Label

The **Label** softkey allows you to add a large text label on the screen. For example, you can use this to indicate what measurement is being taken by the DMM.

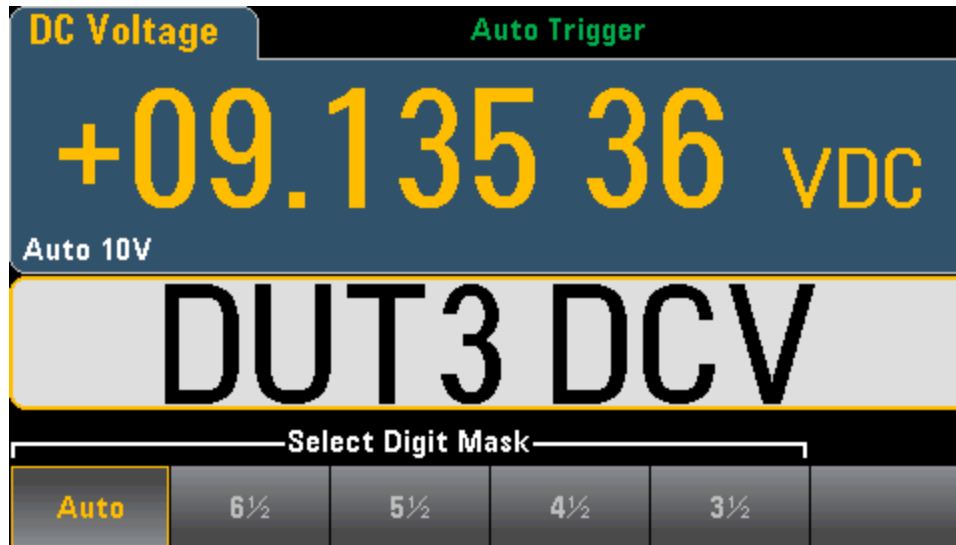

To enter the text, press **Label Text** and use the softkeys and front panel arrow keys to modify the label (below). Then press **Done**. The label's font automatically shrinks to accommodate longer labels.



Selecting a Secondary Measurement

Press **2nd Meas** to select and display a secondary measurement. For example, for the DCV measurement function, you can select ACV, Peak, or Pre-Math as the secondary measurement function. With ACV selected as secondary, the display shows the DCV measurement near to top of the display, and the ACV measurement near the bottom of the display:



Refer to [Secondary Measurements](#) for more information on secondary measurements available for each measurement function.

Specifying the Digit Masking

The Digit Mask softkey specifies the number of digits shown.



For example, the following image shows 6½ digits.

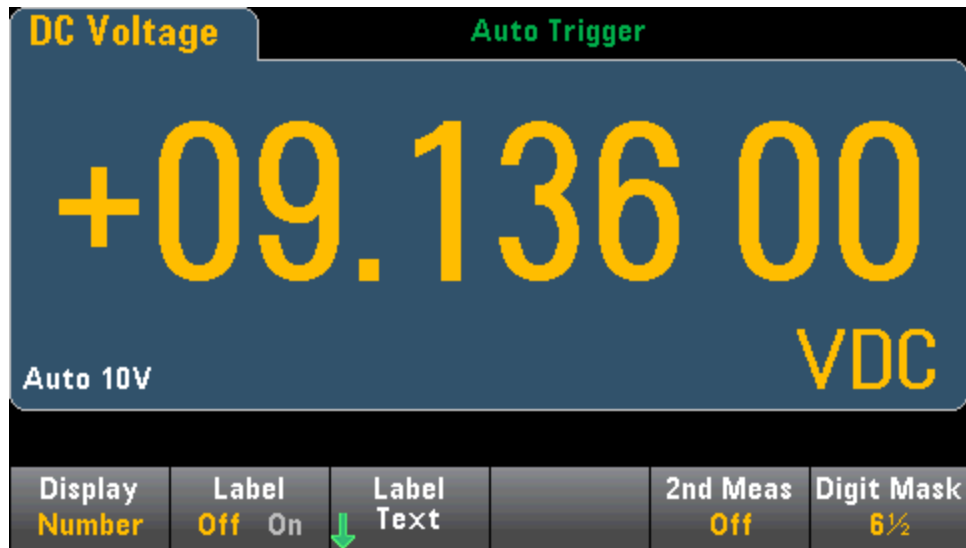

In contrast, this image shows 4½ digits.



The **Auto** softkey specifies that the number of digits displayed is based on other function-specific settings, such as the measurement aperture, set in NPLCs. Measurements are always rounded, never truncated.

Features and Functions

See Also

[Display - Introduction](#)

[Bar Meter](#)

[Trend Chart \(34461A/65A/70A only\)](#)

[Histogram](#)

[Secondary Measurements](#)

Bar Meter

The bar meter (below) adds a moving bar below the standard Number display.

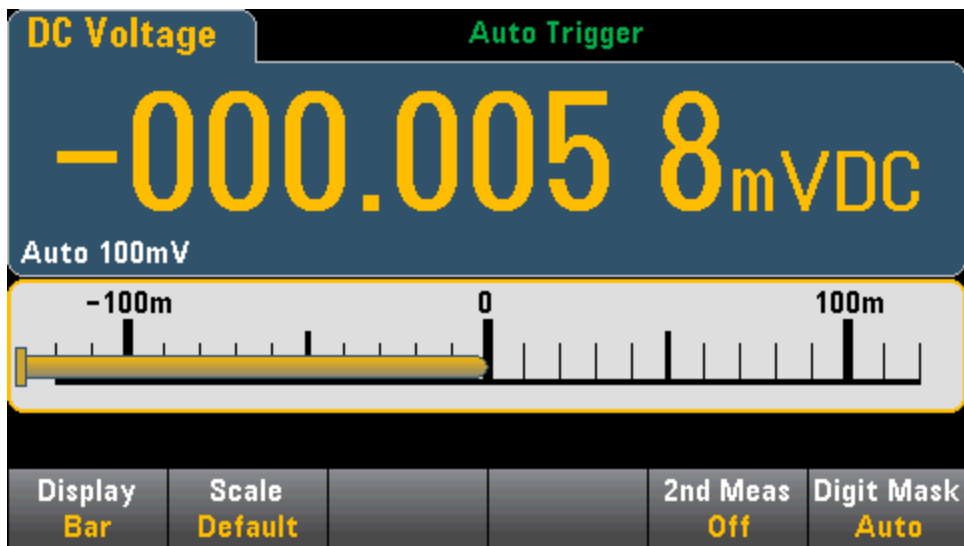

The **Display** and **Digit Mask** softkeys behave as they do in the **Number** display.

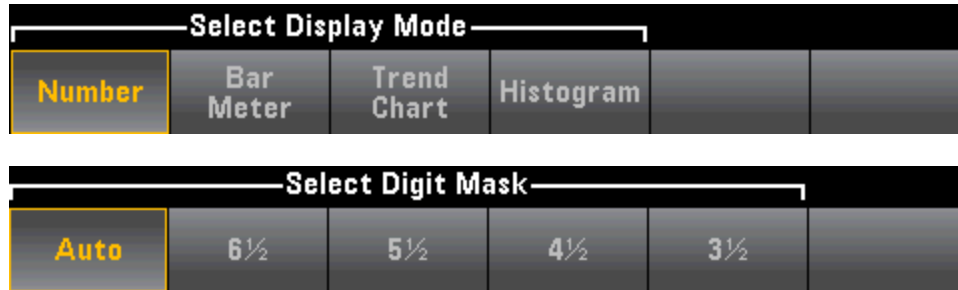

The **Scale** softkey specifies the horizontal scale:



- **Default** sets the scale to equal the measurement range.
- **Manual** allows you to configure the scale either as **High** and **Low** values or as a **Span** around a **Center** value. For example, a scale that goes from a **Low** of -500 Ω to a **High** of 1000 Ω could also be specified as a **Center** of 250 Ω with a **Span** of 1500 Ω.



Selecting a Secondary Measurement

Press **2nd Meas** to select and display a secondary measurement. For example, for the DCV measurement function, you can select ACV, Peak, or Pre-Math as the secondary measurement function. With ACV selected as secondary, the display shows the DCV measurement as a number near to top of the display, DCV in the bar meter, and the ACV measurement above the bar meter:

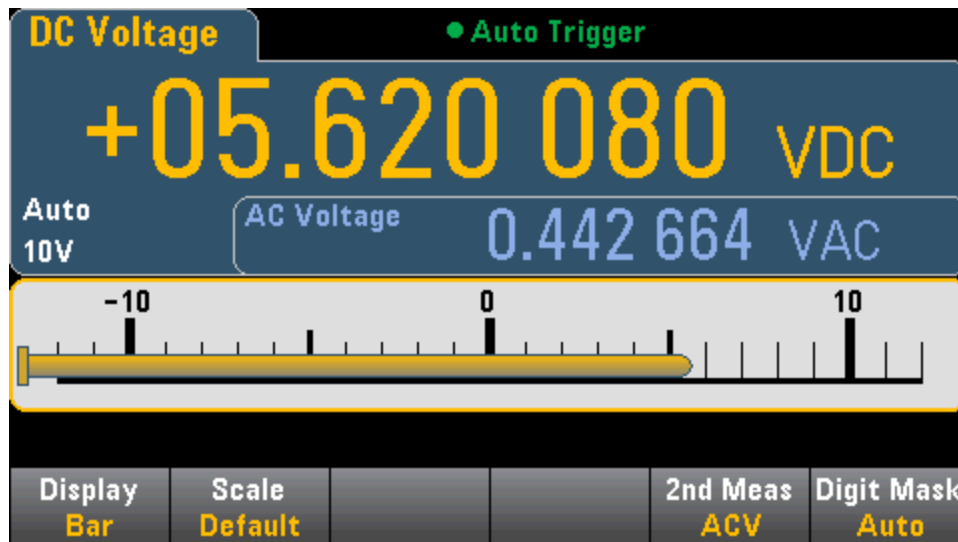

Refer to [Secondary Measurements](#) for more information on secondary measurements available for each measurement function.

See Also

[Display - Introduction](#)

[Number](#)

[Trend Chart \(34461A/65A/70A only\)](#)

[Histogram](#)

[Secondary Measurements](#)

Trend Chart (Continuous Measurement Mode)

This topic describes trend chart behavior for the 34461A/65A/70A only, in Continuous measurement mode. The trend chart is not available for the 34460A.

To select the trend chart, press [**Display**] followed by the **Display** softkey:



In the Continuous measurement mode, the trend chart shows data trends over time:

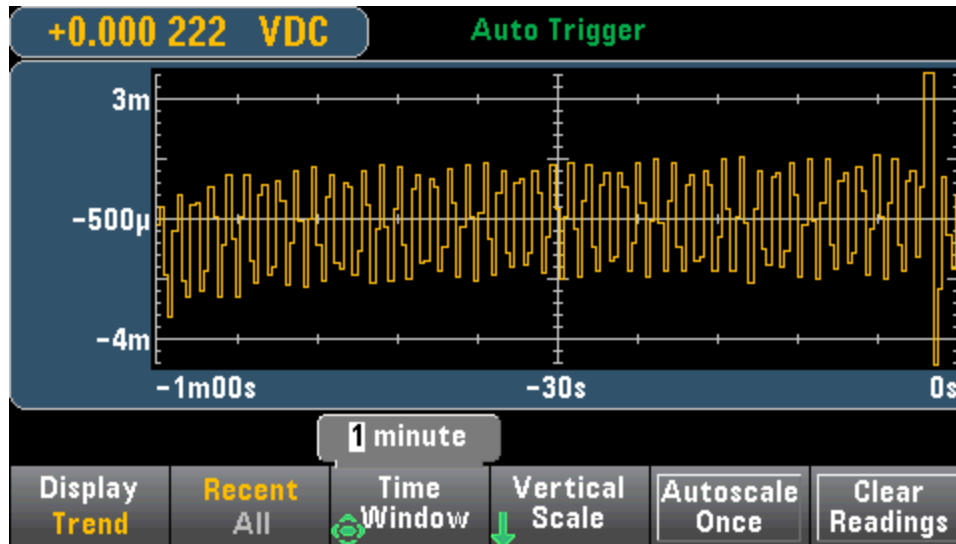

Data is collected and displayed in pixel columns as described below.

Recent/All

The **Recent/All** softkey shows either all of the data in the trend chart (**All**) or just the most recent data (**Recent**). Neither selection clears reading memory.

In All mode, the trend chart displays all readings being taken and builds from left to right. After the display is filled, the data becomes compressed on the left side of the display as new data is added on the right side of the display.

In Recent mode, the trend chart displays data taken during a specified amount of time. For the 34465A/70A, this time is selected with the **Time Window** softkey (1 minute to 1 hour). For the 34461A, this time is fixed at 1 minute, and there is no **Time Window** softkey. Changing this setting clears the trend chart but does not clear reading memory, statistics or histogram data.

Pixel Columns

The trend chart display area is 400 pixels wide by 147 pixels high. A pixel column is 1 pixel wide by 147 pixels high. Each pixel column on the trend chart display represents 1/400 of the Time Window value; the Time Window setting determines the amount of time represented by each pixel column as follows:

- 1 Minute = 150 ms per pixel column - this time is used for the 34461A's Recent mode, and the All mode (34461A/65A/70A)
- 5 Minutes = 750 ms per pixel column (34465A/70A only)
- 10 Minutes = 1.5 s per pixel column (34465A/70A only)
- 30 Minutes = 4.5 s per pixel column (34465A/70A only)
- 1 Hour = 9 s per pixel column (34465A/70A only)

When the reading rate is faster than the time per each pixel column, the column will represent multiple readings. In this situation, the trend chart draws a vertical line in each pixel column showing the maximum to minimum measurement values acquired during that time period:

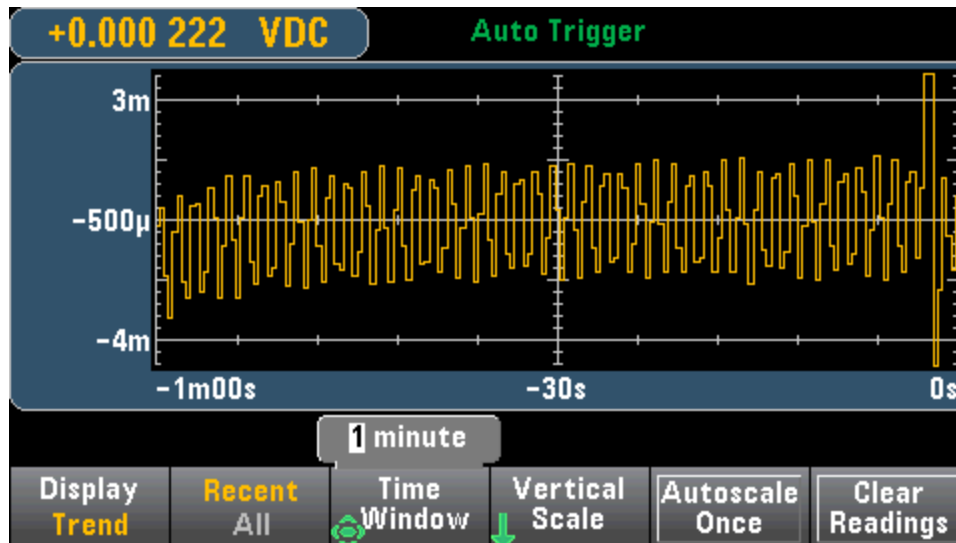

When the reading rate is slower than the time per pixel column, some pixel columns may represent no readings. In this situation, the trend chart continues with a horizontal line across the pixel:

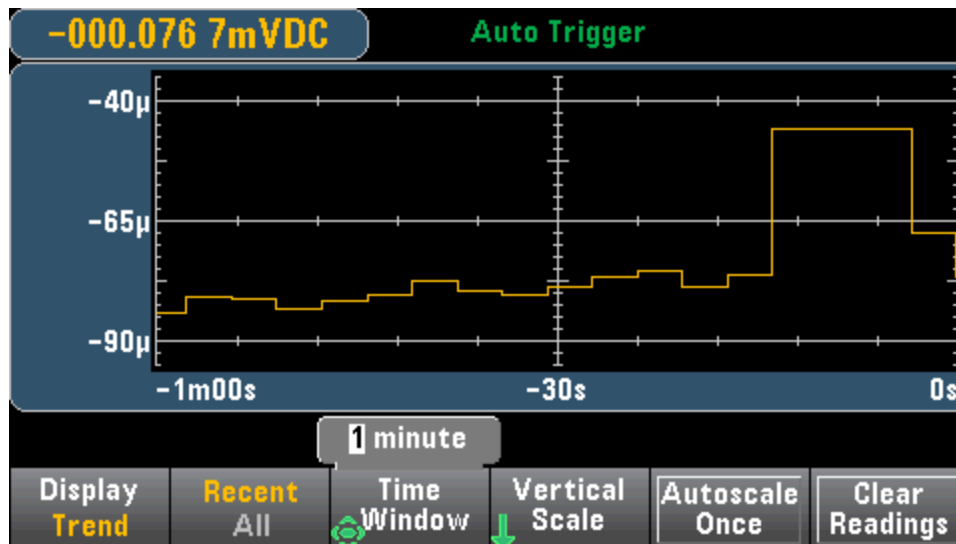

Scaling

The **Vertical Scale** softkey specifies how the current vertical scale is determined.



Press **Vertical**, to change the scaling:



- **Default** sets the scale to equal the measurement range.
- **Auto** automatically adjusts the scale to appropriately fit the line currently shown on the screen.
- **Manual** allows you to configure the scale either as **High** and **Low** values or as a **Span** around a **Center** value. For example, a scale from a **Low** of 0 V to a **High** of 5 V is equivalent to a **Center** of 2.5 V and a **Span** of 5 V.



If you have enabled limits, the **(Limits)** softkey also appears. This sets the vertical scale to match the limits.

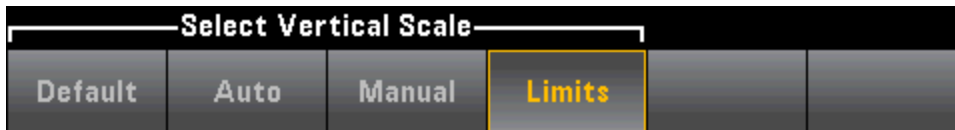

See Also

[Display - Introduction](#)

[Number](#)

[Bar Meter](#)

[Histogram](#)

Trend Chart (Digitize and Data Log Modes)

This topic applies only to 34465A/70 DMMs.

Trend Chart - Digitize Mode

When the 34465A/70A DMM is in digitize mode (DIG option required), Zoom, Pan, and Cursor trend chart controls are available. To enter digitize mode, press **[Acquire]** > **Acquire** softkey > **Digitize**.

To select the trend chart, press **[Display]** followed by the **Display** softkey:



In the digitize mode, these trend chart softkeys are available:

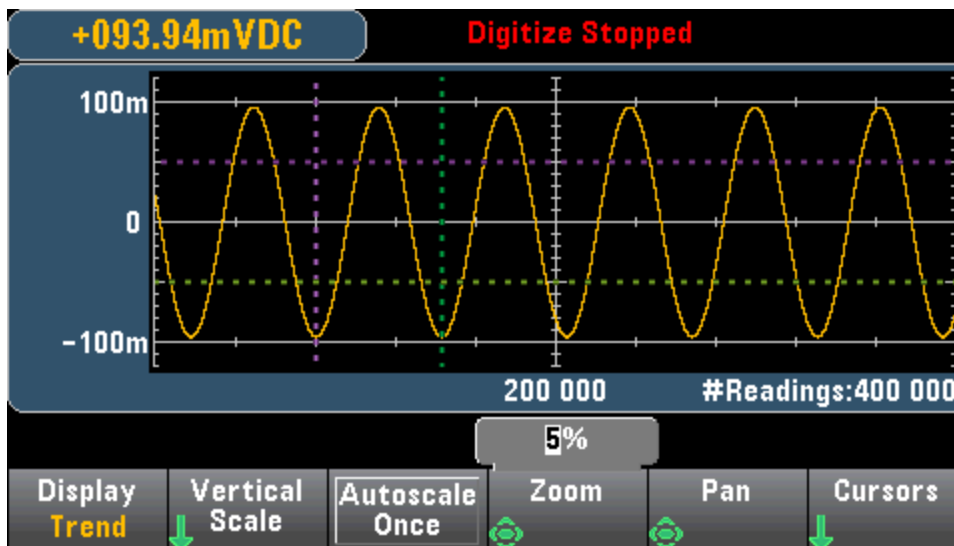

Zoom - Sets the horizontal axis zoom percentage. Press **Zoom** and use the up/down arrow keys to select the amount of zoom, in percent. 100% is the maximum amount of zoom with a maximum of one reading shown per display pixel column. The display is 400 pixels wide. You can select a zoom percentage of 1%, 2%, 5%, 10%, 20%, 50%, or 100%. For example, the graphic above shows 5% zoom and the graphic below shows the same signal at 100% zoom:

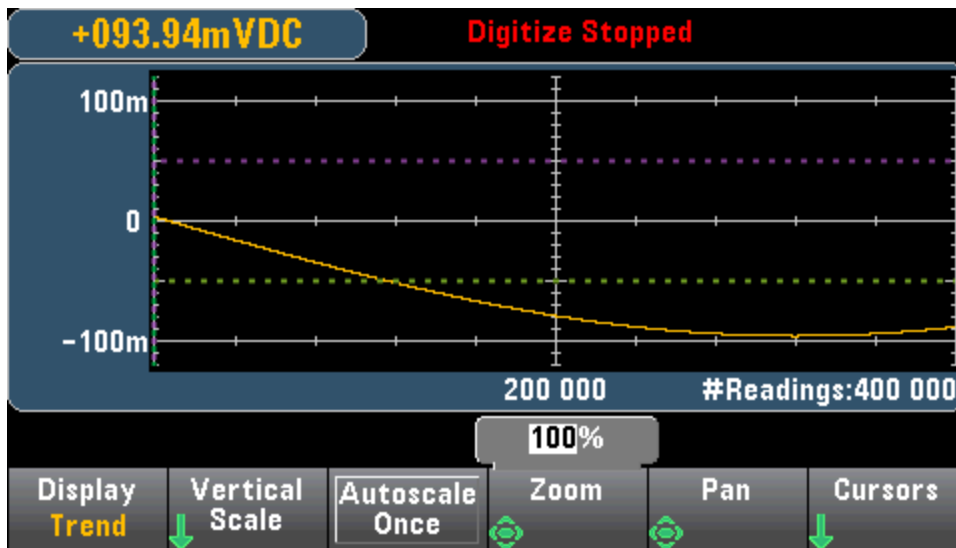

Pan - Selects which reading in memory is displayed at the center of the screen. Use the up or right arrow key to increase the reading number displayed - this causes the graph data to move to the left. Use the down or left arrow key to decrease the reading number displayed - this causes the graph data to move to the right.

Press and release an arrow key to move the cursor one display pixel. Hold down an arrow key to move the cursor in 20 pixel increments. The number of readings represented per pixel depends on the zoom percentage.

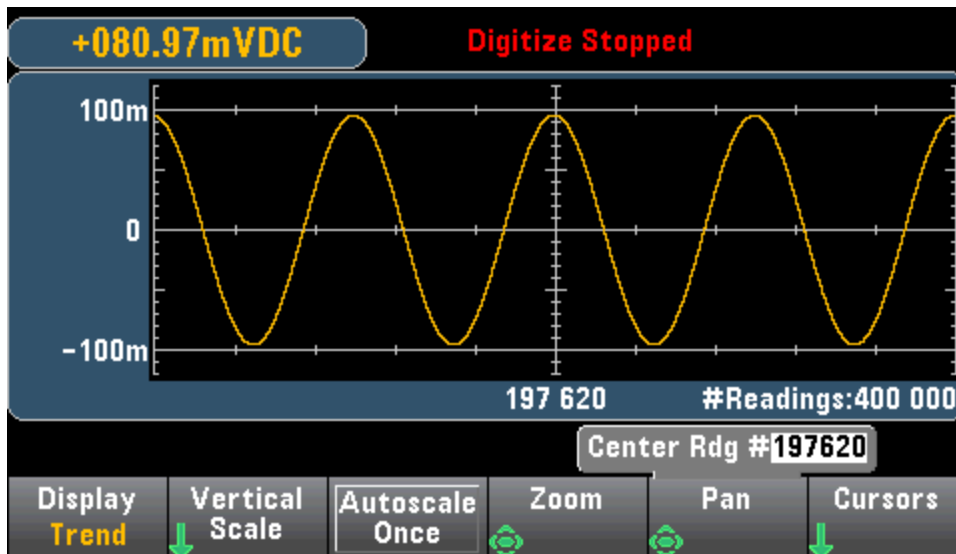

Tip: Zoom to 100% to pan one reading at a time. After selecting a reading, you can then decrease the zoom, if necessary, to view the surrounding signal.

Cursors - Display and control X1, X2, Y1, Y2, and tracking cursors (shown as lines) on the trend chart.

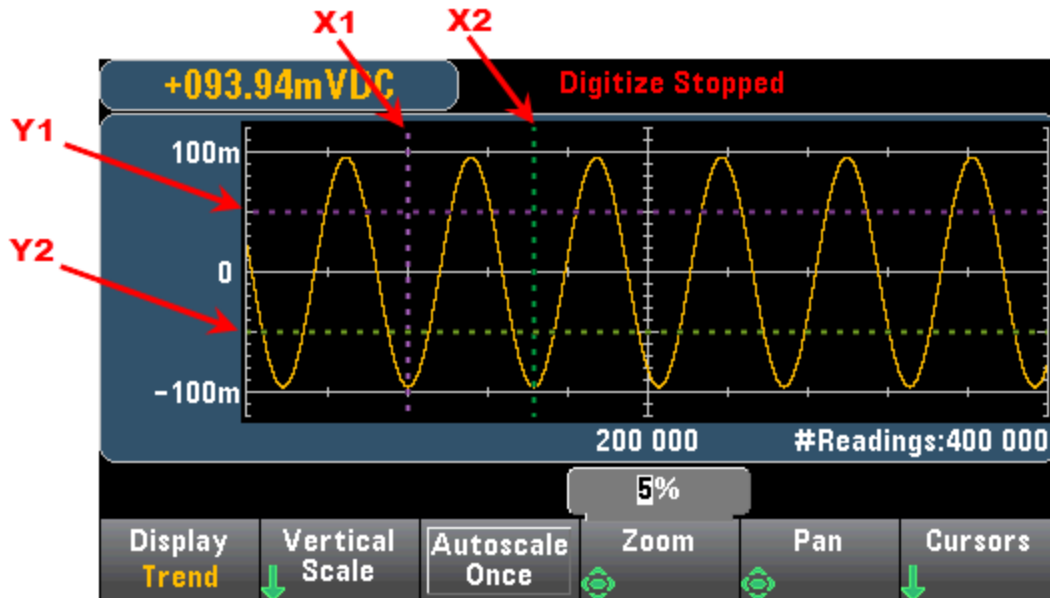

X cursors are vertical lines along the sample or time axis. Use the up or right arrow key to move the cursor to the right; the down or left arrow key to move the cursor to the left. Press and release an arrow key to move the cursor one display pixel. Hold down an arrow key to move the cursor in 10 pixel increments. Y cursors are horizontal lines along the measurement (magnitude) axis in units of the selected measurement (DCV or DCI). Use the left and or right arrow keys to select a digit of magnitude displayed above the Y1 or Y2 softkey. You can then use the up or down arrows keys to increment/decrement the digit and move the cursor up or down by that amount. Cursor X1 and Y1 are violet; cursor X2 and Y2 are green.

Press **Cursors > Cursors** to display the choices:



X Only – Displays only the X1 and X2 cursors. In this mode, these softkeys are available:

- **X1** - Use the arrow keys to control the X1 cursor.
- **X2** - Use the arrow keys to control the X2 cursor.
- **ΔX Lock** - When **ON**, keeps the X cursors a fixed distance apart as either cursor is moved.

Y Only – Displays only the Y1 and Y2 cursors. In this mode, these softkeys are available:

- **Y1** - Use the arrow keys to control the Y1 cursor.
- **Y2** - Use the arrow keys to control the Y2 cursor.
- **ΔY Lock** - When **ON**, keeps the Y cursors a fixed distance apart as either cursor is moved.
- **Place Yn on Screen** - Press **Y1** or **Y2** followed by this softkey to set the cursor to a value that puts it into view on the chart.

X and Y – Displays the X1, X2, Y1 and Y2 cursors. In this mode, these softkeys are available:

Features and Functions

- **X1** - Use the arrow keys to control the X1 cursor.
- **X2** - Use the arrow keys to control the X2 cursor.
- **Y1** - Use the arrow keys to control the Y1 cursor.
- **Y2** - Use the arrow keys to control the Y2 cursor.

Track Rdngr at X - Select two readings, by reading number, using X1 and X2 softkeys to display X (time) and Y (magnitude) values for each reading, and the delta X and delta Y values.

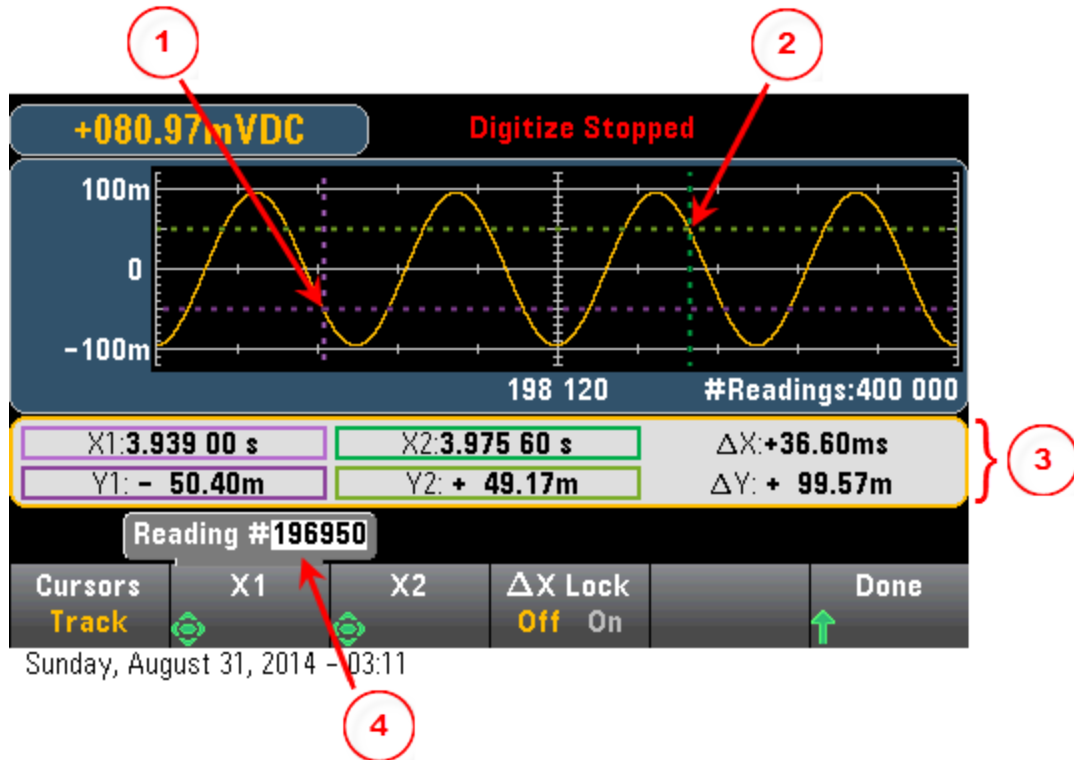

In the graphic above:

- 1 Y1 cursor tracks X1 cursor position.
- 2 Y2 cursor tracks X2 cursor position.
- 3 Cursor time and amplitude information, ΔX , ΔY .
- 4 Press X1 or X2 to display reading number.

These softkeys are available for **Track Rdngr at X** mode:

- **X1** - Use the arrow keys to control the X1 cursor.
- **X2** - Use the arrow keys to control the X2 cursor.
- **ΔX Lock** - When **ON**, keeps the X cursors a fixed distance apart as either cursor is moved.

Tip: To record the X and Y data and the delta X and Y data as a screen shot, take a screen shot of the Web UI, not the front panel screen shot utility.

Trend Chart - Data Log Mode

This topic applies only to the 34465A/70 DMMs, data logging is standard for these DMMs. See [Data Logging](#) for more information on how to configure data logging.

When the DMM is in data log mode, Zoom, Pan, and Cursor trend chart controls are available. To enter data log mode, press [Acquire] > Acquire softkey > Data Log.

To select the trend chart, press [Display] followed by the Display softkey:



In the data log mode, trend chart behavior depends on whether you are data logging to instrument memory, or data logging to a file(s).

Data Logging to Memory

When data logging to memory, the trend chart maps each reading to a dot in a pixel column, draws a line between multiple dots in each column, and draws a line from the last reading in a column to the first reading in the next column.

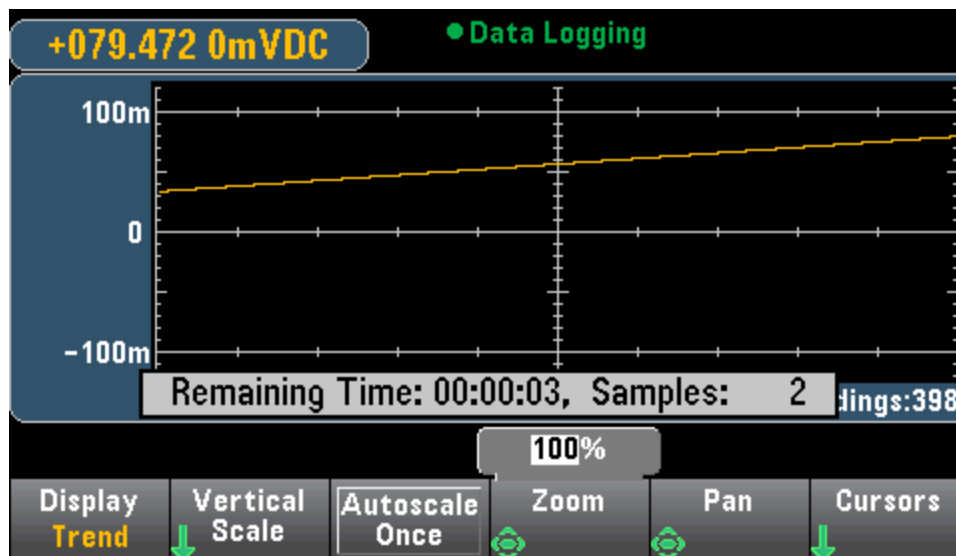

When data logging to memory, Zoom, Pan, and Cursors are available and operate as described above in the digitize section.

Data Logging to File(s)

When data logging to files, the trend chart behaves in a manner similar to that of the continuous measurement mode. That is, the number of readings shown per pixel column depends on the reading rate and the selected Time Window.

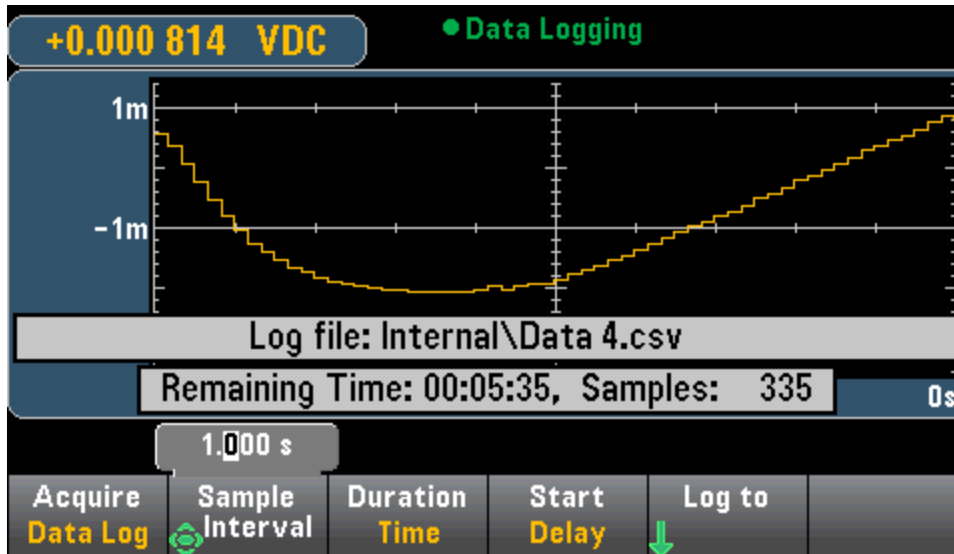

Zoom, Pan, and Cursors are not available when data logging to files. Refer to [Trend Chart \(Continuous Measurement Mode\)](#) for more information.

See Also

[Display - Introduction](#)

[Trend Chart \(Continuous Measurement Mode\)](#)

[Number](#)

[Bar Meter](#)

[Histogram](#)

Histogram

The histogram shows measurement data as a graphical representation of the distribution of measurement data. Data is grouped in bins represented by vertical bars in the histogram display.

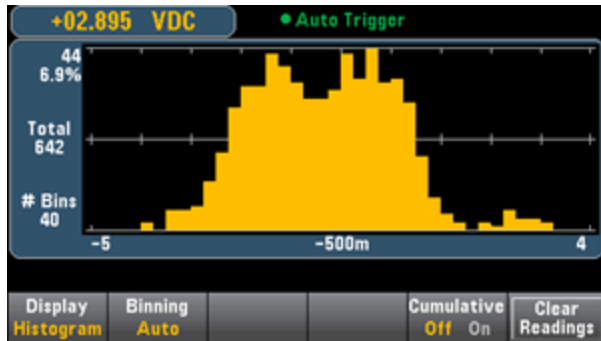

NOTE Autoranging can adversely affect the histogram display when measuring repetitive signals spanning multiple ranges. To avoid this, select a fixed range when using the histogram display.

Selecting the Display

Pressing the **Utility** **Display** key, followed by the **Display** softkey allows you to select the display type:



Binning

The **Binning** softkey allows you to either let the instrument control how the histogram is binned (automatic binning), or to manually specify the binning parameters with the **Bin Settings** softkey. Changing any binning parameter, or switching between automatic and manual binning, will automatically start the histogram over with new data. On the 34461A/65A/70A, this also resets the trend chart.



For **Binning Auto**, the algorithm starts by continuously readjusting the histogram span based on the readings coming in, completely re-binning the data whenever a new value comes in outside of the current span. After acquiring a large number of readings, a new reading outside of the range causes the bins to be compressed by a factor of two such that the new bin range will cover the new reading. The number of bins shown is a function of the number of readings received: 0 to 100 readings = 10 bins, 101 to 500 readings = 20 bins, 501 to 1000 readings = 40 bins, 1001 to 5000 readings = 100 bins, 5001 to 10000 readings = 200 bins, >10000 readings = 400 bins. If the NPLC setting is < 1 PLC, or Aperture Time (34465A/70A only) is < 20 ms, the maximum number of bins is 100.

Features and Functions

For **Binning Manual**, you can set number of bins to 10, 20, 40, 100, 200, or 400. You can specify the bin range as either **Low** and **High** values, or as a **Span** around a **Center** value. For example, the histogram range shown above (from -5 to 4 V) could be specified as a **Low** of -5 V and a **High** of 4 V, or a **Center** of -0.5 V and a **Span** of 9 V.

The **Outer Bins** softkey displays two additional bins, for readings above and below the bin range. For example, this image shows the **Outer Bins** softkey set to **Off**.

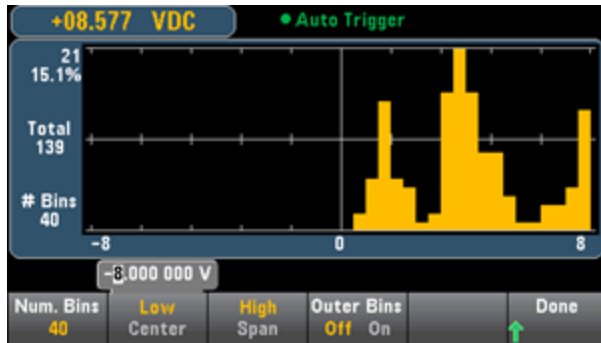

The image below adds the outer bins to the display. The relatively large number of readings above the bin range (the cyan bar) causes the bars within the bin range to shrink.

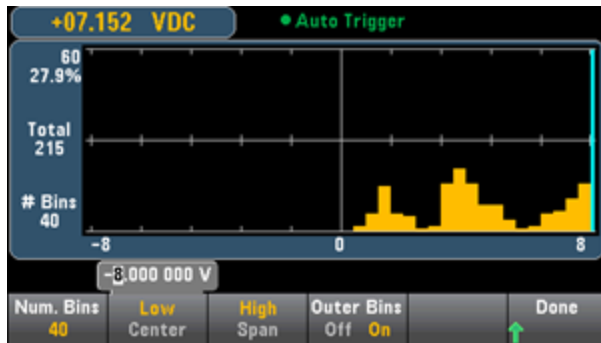

The main histogram menu includes a **Cumulative** softkey that hides or shows a line representing the cumulative distribution of the histogram data. Note that this line represents *all* of the data only when the outer bins are shown; if the outer bins are not shown, the outer bin data is not represented in the line. The cumulative distribution line always goes from 0 to 100% on the vertical scale, regardless of the histogram's scale.

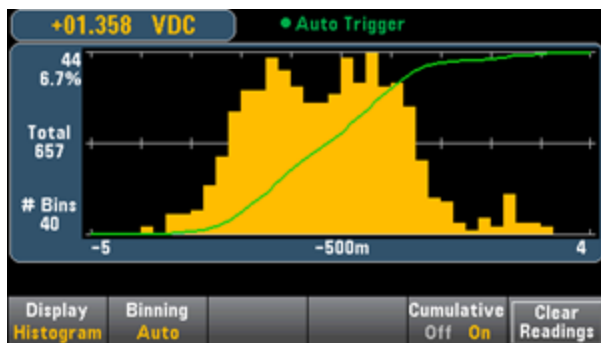

The final button on the histogram menu, **Clear Readings**, clears reading memory and starts a new histogram.

Histogram Data

The graphic below shows a histogram of frequency measurements. Data is displayed on the left side of the histogram. In the graphic below, reading from top left downward:

- **3.011 06 kHz** - present measurement value.
- **48** - Number of samples in the largest bin.
- **19.0%** - Percentage of samples in the largest bin.
- **Total 253** - Total number of samples.
- **# Bins 20** - Total number of bins.
- **0, 2.5k, 5k** - (Below the histogram) Range of frequency values.

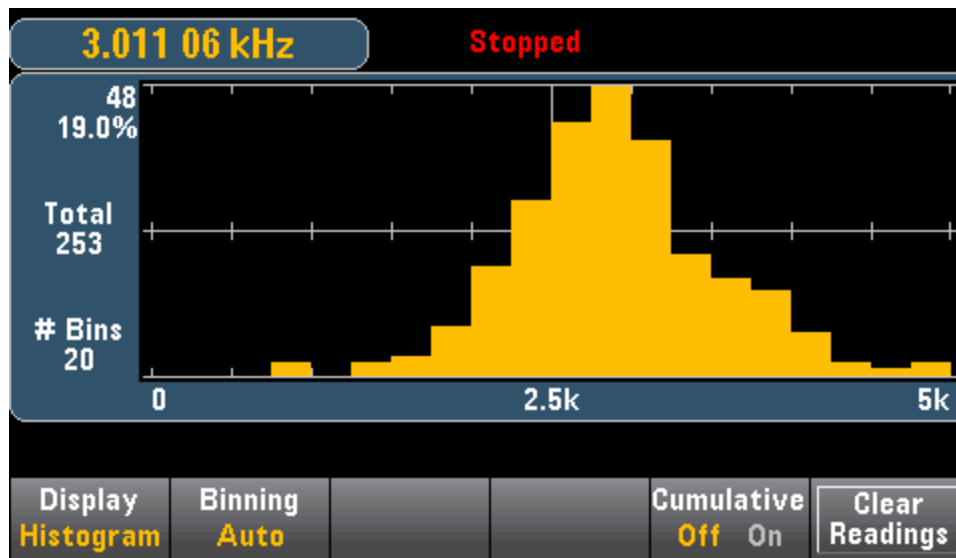

Cursors (34465A/70A only)

Press the **Cursors** softkey (34465A/70A only) to display the histogram cursors.



Cursors in the histogram are specified as bin numbers and display the range of values covered by those bins, the count and the percentage of the total. The total count and percentage of total, as well as the measurement range covered, between the cursor bins, is also displayed. In the graphic below, cursor B1 (violet vertical lines) is positioned on bin number 10 and cursor B2 (green vertical lines) is positioned on bin number 14 (bin number shown above the **B1** softkey). The bin information for cursor B1 is shown in the violet box, the bin information for B2 in the green box. For example, the information in the B1 box is in the graphic below is:

- **2.250 00 k to 2.500 00k** - Range of frequency measurement values for this bin.
- **#29** - Number of samples in this bin.
- **11.5%** - Percentage of the total number of samples in this bin.

The data between the B1 and B2 cursors, including the data in the B1 and B2 bins, is shown to the right of the violet and green boxes. In the graphic below:

- **Span:** - The measurement range covered from B1 to B2.
- **#178** - The number of samples from B1 to B2.
- **70.4%** - The percentage of the total number of samples from B1 to B2.

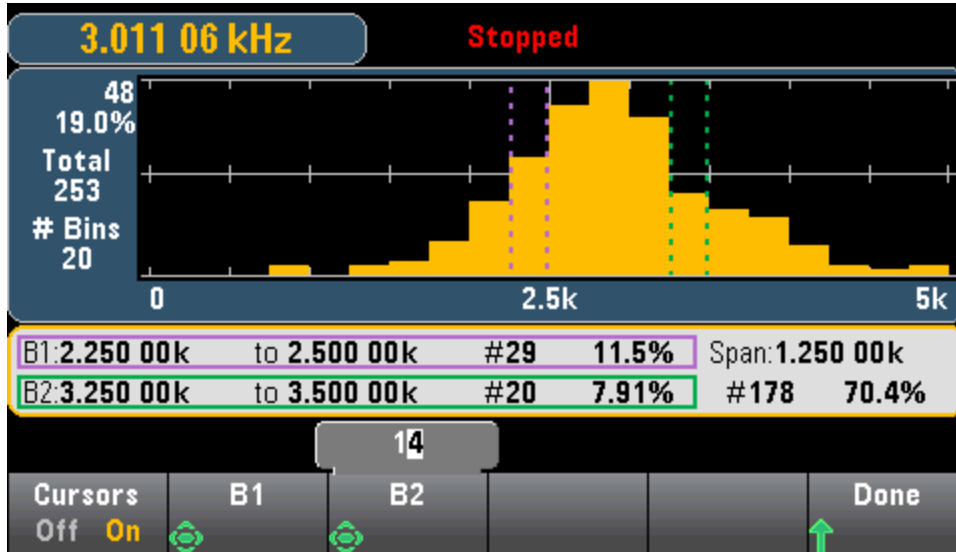

When Outer Bins are shown (when using manual binning) a zero cursor value indicates the outlier count below the histogram range, and one plus the number of bins indicates the outlier count above the histogram range.

Histogram with Statistics

Showing statistics (**Shift > Math > Statistics**) is particularly useful for the histogram display. For example, in the graphic below, the thick blue line is the average, each thin blue line represents one standard deviation from the average.

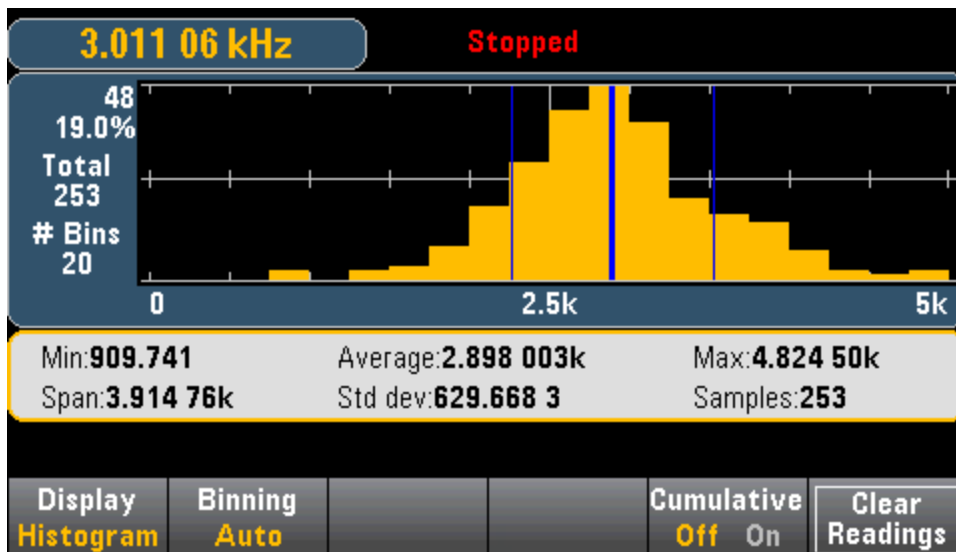

See Also

[Display - Introduction](#)

[Number](#)

[Bar Meter](#)

[Trend Chart \(34461A/65A/70A only\)](#)

Utility Menu - Introduction

The **[Utility]** key is the shifted **[Display]** key:



[Utility] provides the following features:



Store and Recall State and Preference Files

Manage files, including creating screen shots

Configure LAN (optional on 34460A), GPIB (optional on all models), and USB

Perform instrument self-tests and administrative functions

Configure the instrument's date and time and various user settings

Utility - Autocalibration (34465A/70A only)

Autocalibration compensates for drift caused by time and temperature change in DC voltage and resistance measurements, and adjusts some aspects of other measurement functions.

To quickly perform autocalibration without editing the cal string message, press **Shift > ACAL (Up Arrow)** key.

Use the procedure below to use menus and softkeys to edit the cal string message and perform autocal

Step 1: Press **Utility** on the front panel.

Step 2: Press the **Test/Admin** softkey:



Step 3: Press the **Calibrate** softkey:



Step 4: (Optional step) Press the **Edit Cal String** softkey and enter the information for the cal string message. Common messages include the last calibration date, calibration due date, or calibration department contact information. When finished, press the **Done** softkey

Step 5: Press the **Perform Autocal** softkey:

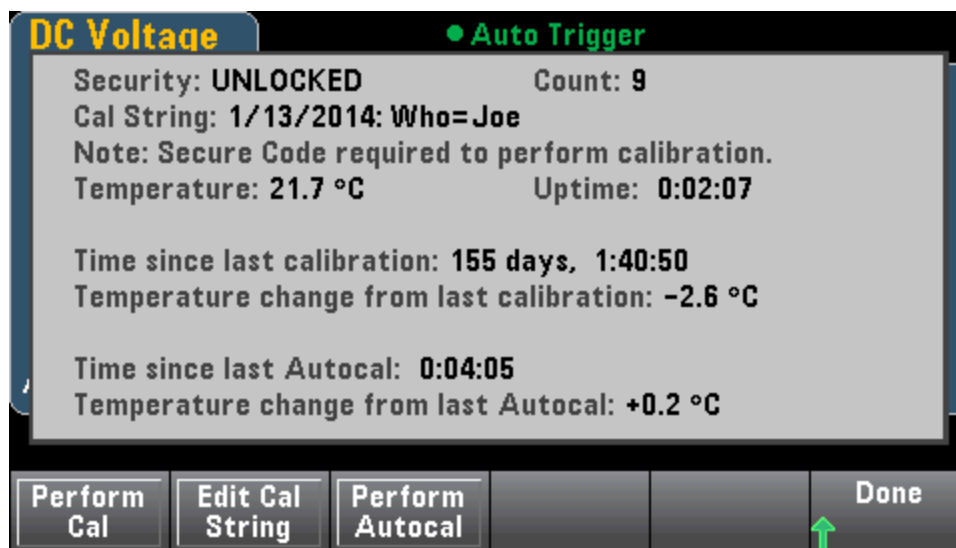

Utility - Store and Recall State and Preference Files

The Utility menu is shown below.

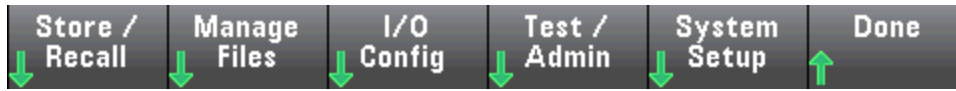

Press **Store/Recall** to save and recall state and preference files. In general, state files store volatile settings associated with measurements. Preferences are non-volatile parameters associated with the instrument, but not any specific measurement. For details, see the table in the [MMEMory State and Preferences Subsystem](#).



Store Settings

Store Settings allows you to browse to a directory and specify a file name, and to choose whether you want to store a state file or a preference file.



Press **Type** to select whether you want to store a state or preferences file, and press **Store State** (shown above) or **Store Pref** (the softkey's label if you are storing preferences) to store the specified file.

Action allows you to either store a file or to create a new folder.



Recall Settings

Recall Settings allows you to browse to the file to be recalled. Use the arrow keys to navigate to the desired state file (*.sta) or preferences file (*.prf).



Power On

Power On selects the state that is loaded at power-up. This can be either the state when the instrument was powered down with the power switch (**Last**), a user-selected state file (**User Defined**), or the factory default state (**Factory Defaults**).



Set to Defaults

Set to Defaults loads the instrument's factory default state or preference settings.

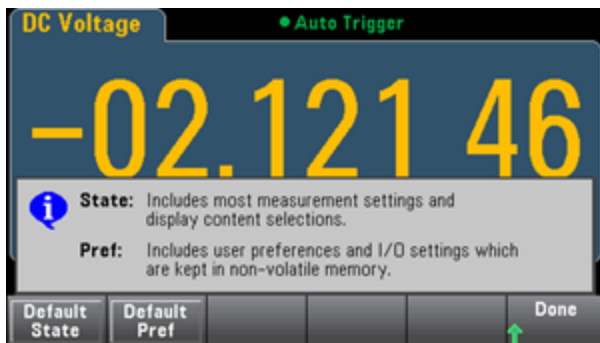

Utility Menu - Manage Files



The **Manage Files** softkey allows you to create, copy, delete, and rename files and folders in the instrument's internal flash memory or on a USB drive attached to the front panel. It also allows you to capture the current screen to either a bitmap (*.bmp) or portable network graphics (*.png) file. This is the default option, as shown below.



Action

Action specifies the action to perform. Pressing **Capture Display** saves a screen capture of the display at the moment that you pressed **[Shift]** to go to the **[Utility]** menu.



Delete - To delete a file or folder, press **Delete** and **Browse** to the folder or file to delete. Press **Select** > **Perform Delete** > **Done**.

Folder - To create a folder, **Browse** to the internal or external location for the folder, press **File Name**, enter a folder name and press **Done**. Press **Create Folder** > **Done**.

Copy - To copy a file or folder, press **Copy**. **Browse** to the folder or file to be copied and press **Select**. Press **Copy Path** and select an internal or external path for copying. Press **Perform Copy** > **Done**.

Rename - To rename a file or folder, press **Rename**. **Browse** to the folder or file to be renamed and press **Select**. Press **New Name**, enter a new name and press **Done**. Press **Perform Rename** > **Done**.

Browse

Browse selects the file or folder upon which the action will be performed.

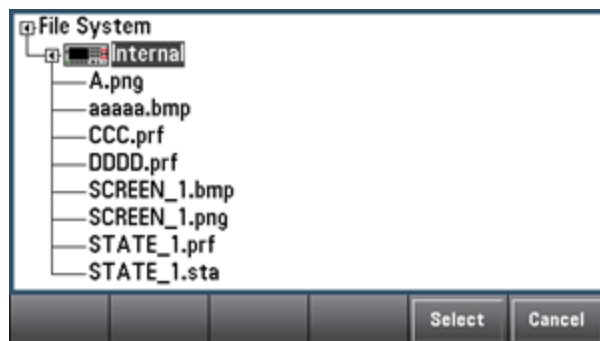

Use the front panel arrows and **[Select]** key to navigate through the list, and press **Select** or **Cancel** to exit the browse window. The left and right arrows contract or expand a folder to hide or show its files.

File Name

File Name allows you to use the front panel arrows, the **[Select]** key, and the softkeys to enter a file name. Use the front panel arrows to point to a letter, and **Previous Char** and **Next Char** to move the cursor in the area where the name is entered. In the image below, there is no **Next Char** softkey because the cursor is at the end.

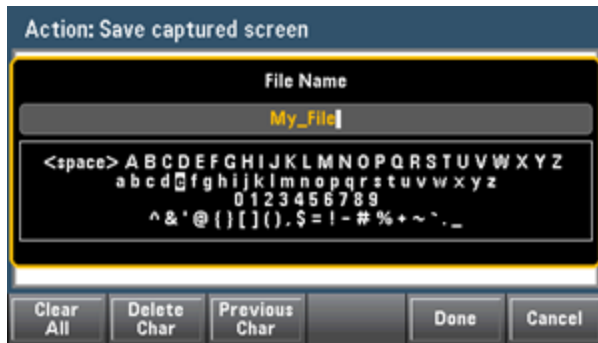

Press **[Done]** or **[Cancel]** to finish.

Utility Menu - I/O Configuration



I/O Config configures the I/O parameters for remote operations over the LAN (optional on 34460A), USB, or GPIB (optional) interface.



LAN enables and disables the instrument's LAN interface, and **LAN Reset** resets the LAN using its current settings and enables DHCP and mDNS. The **LAN Reset** softkey also clears any user-defined Web Interface password.

LAN Settings

LAN Settings opens the menu shown below. **Set to Defaults** resets the LAN settings to their default values.



Modify Settings

Modify Settings enables DHCP or Manual (Auto-IP) assignment of the instrument's IP address. It also enables configuration of network parameters based on the protocol (DHCP or Manual) selected.



For example, press **Host Name** or **Service mDNS** to modify the instrument's host name or mDNS Service Name, shown below.

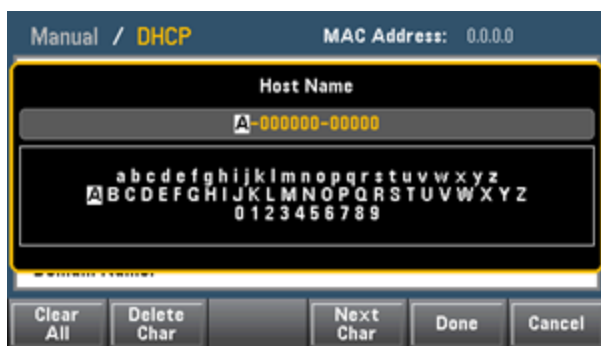

LAN Services

LAN Services enables and disables the LAN services shown below.

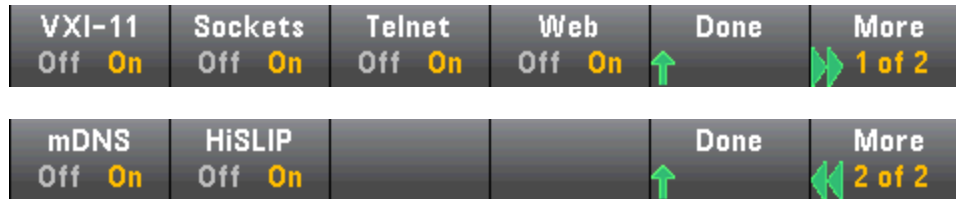

After enabling/disabling one or more services, press **Done** > **Apply Changes**. After that, you must cycle instrument power for the new settings to take effect.

The Web server enables or disables instrument programming from the instrument's Web interface.

The multicast DNS (mDNS) service is for use in networks where no conventional DNS server is installed. Cycling power or resetting the LAN always enables mDNS.

The instrument Telnet port is 5024. Open SCPI sessions on the Telnet connection by entering:

```
telnet IP address 5024
```

Refer to the Keysight IO Libraries help for information on the VXI-11, Sockets, and HiSLIP protocols.

USB Settings

USB Settings configures the front panel USB (storage) and rear-panel USB (connectivity) connectors.



NOTE The SEC licensed option also gives you the ability to enable or disable the front panel USB interface via a **USB Front** softkey. This option can be ordered as factory option or as customer-installable option. See [Models and Options](#) for details. Without this option, the front panel USB interface is always enabled.

USB SCPI

USB SCPI enables or disables the rear-panel USB control port. After changing the interface state, cycle instrument power to make the change take effect. When disabled, the interface cannot be configured by the Keysight IO Libraries Connection Expert utility.

Features and Functions

Easy File Access (File Access Softkey)

Easy File Access uses media transfer protocol (MTP) to easily download instrument files to your PC. Simply connect the rear-panel USB port on the instrument to a USB port on your PC. The DMM will appear as a read-only drive on your PC's file system.

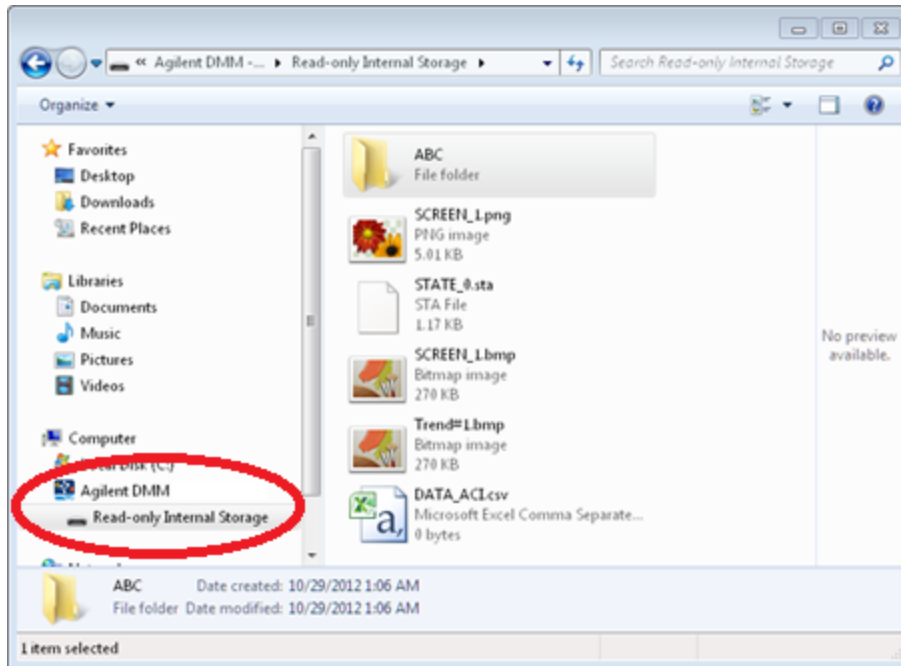

You can use your PC's standard file management features to copy files from the DMM to your PC.

NOTE To use **Easy File Access** at the same time that you are remotely programming the instrument with SCPI over the USB interface (**USB SCPI**), you must have Keysight IO Libraries Suite 16.3 or later installed on your PC. You may download the latest version at www.keysight.com/find/iosuite.

To use **Easy File Access** on a PC running the Windows XP operating system, make sure you have Microsoft Windows Media Player 11 for Windows XP SP1, or are using a Microsoft Windows XP SP2, SP3, or a newer version of Windows. You may download this software at www.microsoft.com/en-us/download/details.aspx?id=8163.

GPIB Settings (optional)

GPIB Settings enables or disables your instrument's GPIB interface.

When disabled, the interface cannot be configured by the Keysight IO Libraries Connection Expert utility.

You can also set GPIB address to a value from 0 to 30. After enabling or disabling GPIB or changing the address, cycle instrument power for the change to take effect.



Utility Menu - Test/Admin



Test/Admin provides access to self-test, calibration, and administrative functions:



Self-Test

Self-Test verifies proper instrument operation. See [Self-Test Procedures](#) for details, and always safely disconnect inputs to the DMM terminals before running the Full Test.

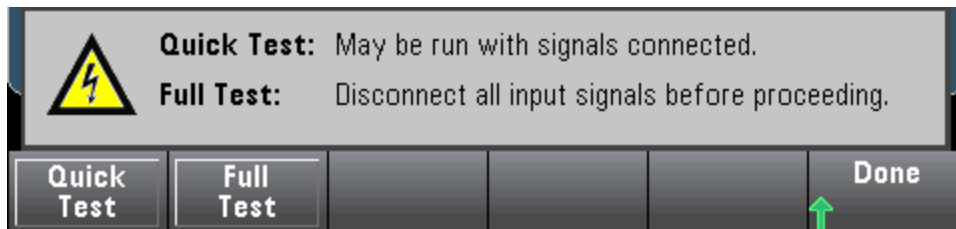

Calibrate

Calibrate accesses the instrument calibration procedure. See [Calibration](#) for details.

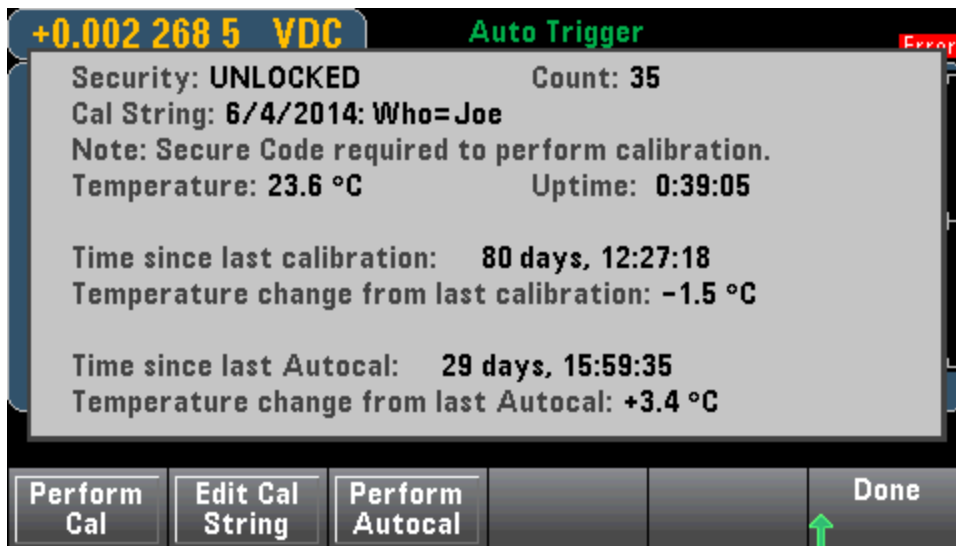

Security

Security manages the secure code and security features. If you have the SEC option, you must enter the Secure Code to configure some features.

NISPOM Sanitize sanitizes all user-accessible instrument memory except for the calibration constants and reboots the instrument. This complies with requirements in chapter 8 of the National Industrial Security Program Operating Manual (NISPOM).

CAUTION

The **NISPOM Sanitize** softkey and the SYSTem:SECurity:IMMEdiate command are equivalent. They are for customers, such as military contractors, who must comply with NISPOM.

This feature destroys all user-defined state information, measurement data, and user-defined I/O settings such as the IP address. This feature is not recommended for use in routine applications because of the possibility of unintended data loss.

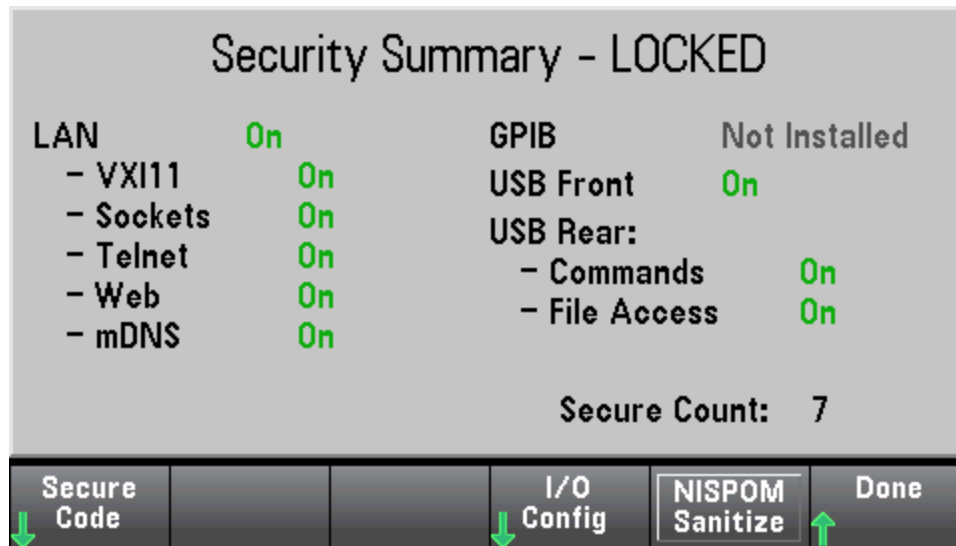

Install License

Install License enables licensed instrument features. For information on obtaining licenses, go to www.keysight.com/find/truevolt.

After receiving a license file from Keysight, use the following procedure to install the license:

1. Save the license file to a USB drive and connect the USB drive to the DMM's front panel USB connector.
2. Press [Shift] > [Utility] > Test/Admin > Install License.
3. Use the front panel arrow keys to navigate to the license file location and press **Select**.
4. Upon successful license installation, the DMM displays **License Installation Successful**.

Firmware Update

Firmware Update updates the instrument firmware to a new version. See [Firmware Update](#) for details.

Utility Menu - System Setup



System Setup configures user preferences, sets the date and time, and sets a power-on message.



User Settings

User Settings specifies user preferences that control how you interact with the instrument. These settings are stored in non-volatile memory and can be saved in a preferences (.prf) file.



Help Language

Help Lang selects the help language for front panel use: English, French, German, Japanese, Korean, Russian, or Simplified Chinese. All messages, context-sensitive help, and help topics appear in the selected language. The softkey labels are always in English.

Number Format

Number Format specifies how numbers are displayed on the front panel: 12,345.6 or 12.345,6. Other possibilities also exist. For example, you can use the space as a separator.



Sounds



Disables or enables the click heard when a front panel key or softkey is pressed.

Also enables or disables the audible tone (**Beeper On or Off**) associated with the following features:

- Limits – a measurement limit is exceeded (if limits are enabled)
- Probe Hold – the measured signal records a stable reading
- Diode – the forward bias voltage is between 0.3 and 0.8 V
- Continuity – a short is measured (less than or equal to 10 Ω)
- Error - an error is generated from the front panel or remote interface

Features and Functions

This non-volatile setting appears in several different menus on the front panel. Turning the beeper on or off in one menu affects all of the other menus and functions. For example, turning the beeper off for probe hold, also turns the beeper off for limits, diode, continuity, and errors.

Display Options

Display Options configures the display.



You can enable or disable the display, adjust the brightness (10 to 100%), enable or disable the screen saver, and pick a color scheme. If you turn off the display, press any front panel key to turn it on again.

By default, the screen saver turns off and blanks the screen after eight hours of inactivity. You may disable this screen saver from the front panel only.

The display is enabled when power is cycled, after an instrument reset (***RST**), or when you return to local (front panel) operation. Press the **[Local]** key or execute the IEEE-488 GTL (Go To Local) command from the remote interface to return to the local state.

SCPI ID

SCPI ID determines the instrument's response to a ***IDN?** query. Choices for each DMM model are:

- **34460A** - 34460A, AT34460A, HP34401A
- **34461A** - 34461A, AT34461A, HP34401A
- **34465A** - 34465A, AT34410A, AT34411A
- **34470A** - 34470A, AT34410A, AT34411A

Choices above with no prefix (34460A, for example) return Keysight Technologies as the manufacturer. Choices above with an AT or HP prefix, return Agilent Technologies or Hewlett Packard, respectively, as the manufacturer. These choices are included for ***IDN?** compatibility with existing programs that expect ***IDN?** to return a particular manufacturer and model number.

If you have an older Agilent 34460A or 34461A and upgrade to the new (Keysight) firmware, your instrument continues to respond with the manufacturer name “Agilent”, not “Keysight” until you set the front panel SCPI ID to 34460A or 34461A, send the **SYST:IDEN DEF** command, or reset user preferences. After doing this, the instrument responds with “Keysight” as the manufacturer.

Important: In order to update the instrument firmware *from remote*, the model number in the ***IDN?** response must match the actual instrument model number. If you have changed the instrument's ***IDN?** response to another instrument, when attempting to update the firmware from remote, you will see this error: *The instrument is not supported by this firmware file.* To update the firmware, either update using the front panel procedure or, from remote, use **SYSTem:IDENtify** to set the ***IDN?** to match the actual model number, update the firmware, and then use **SYSTem:IDENtify** again to set the ***IDN?** response to the other model number.

Date / Time

Date / Time sets the instrument's real-time clock, which always uses a 24-hour format (00:00:00 to 23:59:59). There is no automatic setting of the date and time, such as to adjust for daylight savings time. Use the front panel arrow keys to set the year, month, day, hour, and minute.

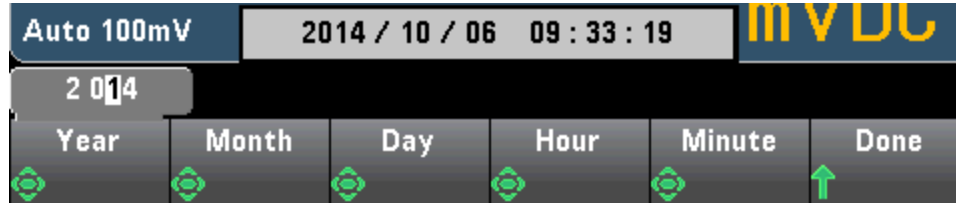

Power on Message

Power on Message sets a message that is displayed when the instrument powers up and when you press [Help] > About.



Use the front panel arrows and [Select] key to select the letters. Then press **Done** to exit and save the message. The message will appear as shown below when you turn the instrument on or press [Help] > **About**.



Web Interface

The Keysight Truevolt Series DMMs include a built-in Web Interface for monitoring and controlling the instrument via a Web browser. To begin, connect your instrument to the LAN and enter the instrument's IP address into the address bar at the top of your PC's Web browser, or select the instrument in Connection Expert and click the **Instrument Web Interface...** button. The Web Interface will appear in the browser as shown below (34465A DMM shown).

NOTE The following is a high-level overview of the four Web Interface tabs shown on the left side of

the Web Interface window. When using the Web Interface, click the help button  for detailed information on any page, for example:



Welcome Page

The Welcome Page displays basic instrument information. To change any of the information displayed on this page, use the [Configuration Page](#).

Instrument Documentation and Technical Support | Keysight Home

KEYSIGHT TECHNOLOGIES 34465A 6-1/2 Digit Multimeter

Welcome to your

Web-Enabled 34465A
[Instrument Documentation and Technical Support](#)

Information about this Web-Enabled 34465A:

Instrument:	34465A
Serial Number:	PROTO00027
Description:	Keysight 34465A Digital Multimeter - PROTO00027
DNS Hostname:	DavesUnit
NetBIOS Name:	DavesUnit
mDNS Hostname:	DavesUnit.local.
IP Address:	156.140.92.2
Instrument Address String:	TCPIP::DavesUnit::hisip0::INSTR TCPIP::DavesUnit::inst0::INSTR

Turn On Front Panel Identification Indicator

Advanced information about this Web-Enabled 34465A

Use the navigation bar on the left to access your 34465A and related information.

© Keysight Technologies 2014



Instrument Monitor and Control Page

This page allows you to monitor and control the DMM. This page opens in the *Observe Only* mode and automatically opens the Monitor DMM window (described below). In *Observe Only* mode, the instrument control settings are grayed out (disabled). This mode allows you to keep track of DMM operations remotely. The **About** section shows installed licenses, the instrument firmware revision, and the instrument serial number.

In *Allow Full Control* mode, this window configures the instrument and takes measurements. Simply select the DMM settings and click **Apply**.

The six buttons along the top of the screen are described below.

Monitor DMM

When the main page is set to *Observe Only* mode, this window opens showing a textual display of DMM readings, secondary measurements (if enabled), and statistics. In *Allow Full Control* mode, the **Clear All** and, if applicable, **Clear Peaks** buttons become active:

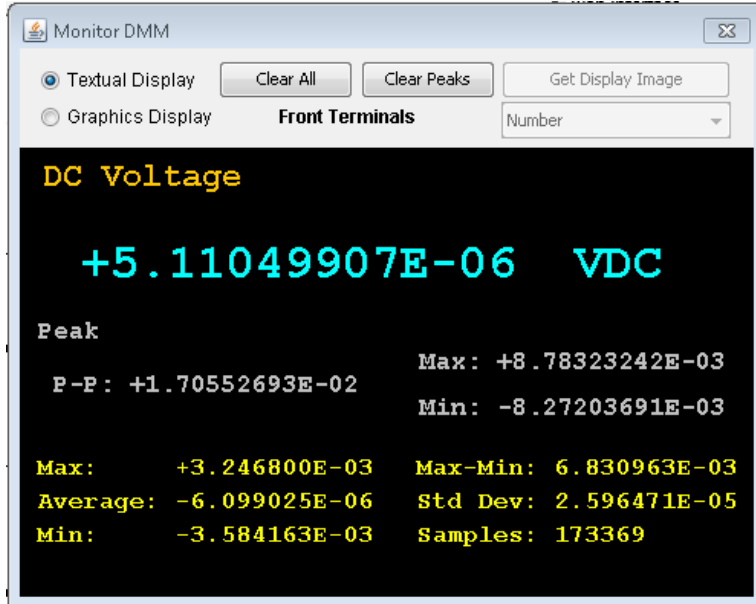

In *Allow Full Control* mode, to view data as shown on the instrument's graphical display (trend chart, histogram, and so on), click the **Graphics Display** radio button and click **Get Display Image** to update the graphical display:

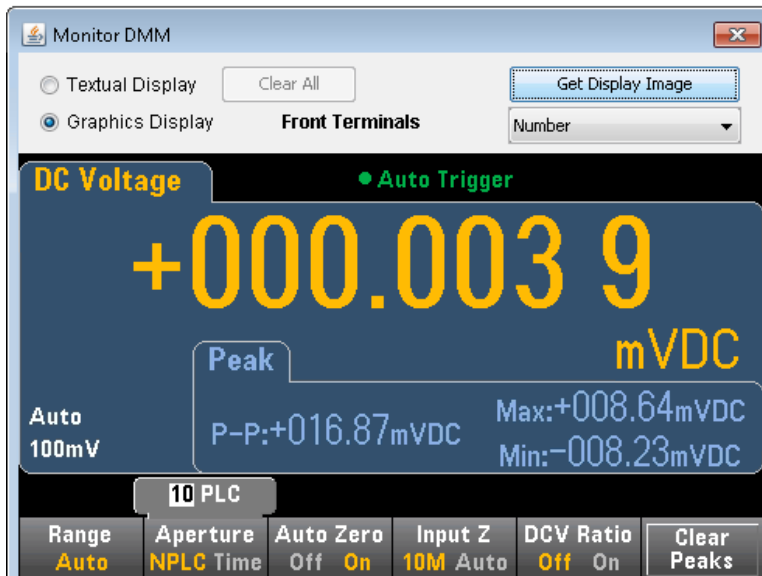

View Data

For both the *Observe Only* and *Allow Full Control* modes, this window keeps a running display of **Readings in Memory** and has these active controls:

- **Readings** - Enter a **Start Index** (reading number) and **Number of Readings to Get** and click **Get Data** to display those readings at the bottom of the window. Readings are not cleared from instrument memory. Use the checkboxes to enable/disable the displayed **Index** or **Units**. Use the mouse to highlight any displayed data and press **Ctrl-C** to copy to the Windows Clipboard. Click **Clear Data Window** to erase the readings in the display.
- **Last Value** - Click **Last Value** > **Get Data** to display the last reading taken by the DMM.
- **Statistics Data** - Click **Statistics Data** > **Get Data** to display Maximum, Average, Minimum, Max-Min, Standard Deviation, and Samples (number of readings).
- **Histogram Data** - Click **Histogram Data** > **Get Data** to display Reading Count, Auto Bin (On or OFF), Number of Bins, Upper Range, Lower Range, and Bin Data.

For the *Allow Full Control* mode, this window has these additional controls:

- **Read and Remove Readings** - The **Start Index** is fixed at 1. Enter the number of **Readings to Remove** and click **Get Data** to display those readings at the bottom of the window. The readings displayed ARE cleared from instrument memory.
- **Delete All Readings** - Deletes all readings in the instrument reading memory and does not display any readings.

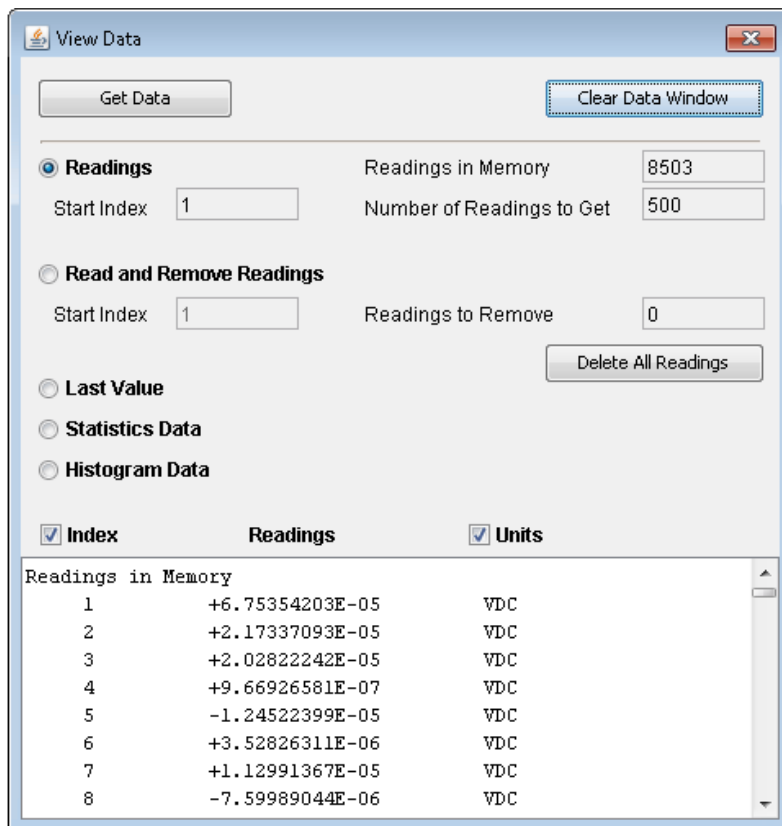

DMM Overview

This window generates reports with information such as the instrument's firmware, configuration, calibration, SCPI configuration, and error queue. Check the desired boxes on the left side of the screen and then click **Generate Report**. The **Change in SCPI Configuration** box produces a list of all of the SCPI

Features and Functions

commands required to change the instrument state since the last time a report was generated. This provides a convenient way for you to learn SCPI syntax.

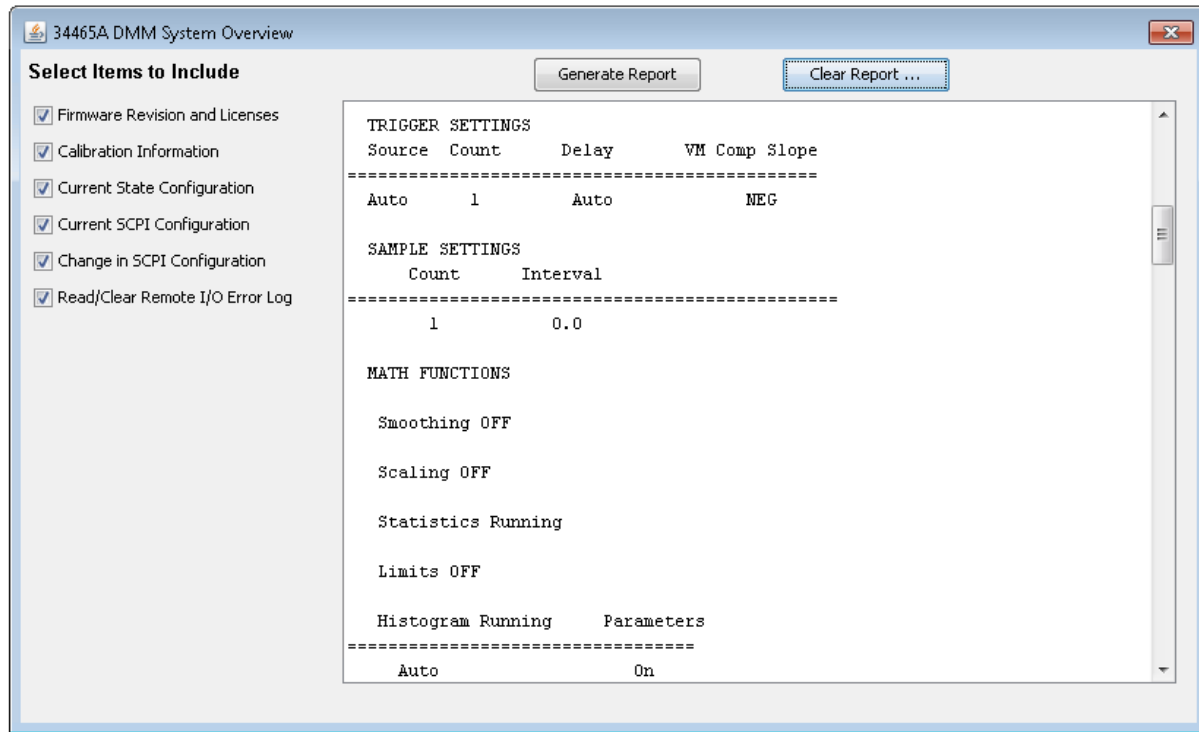

Store/Recall

In the *Allow Full Control* mode, this window saves, recalls, and deletes instrument states.

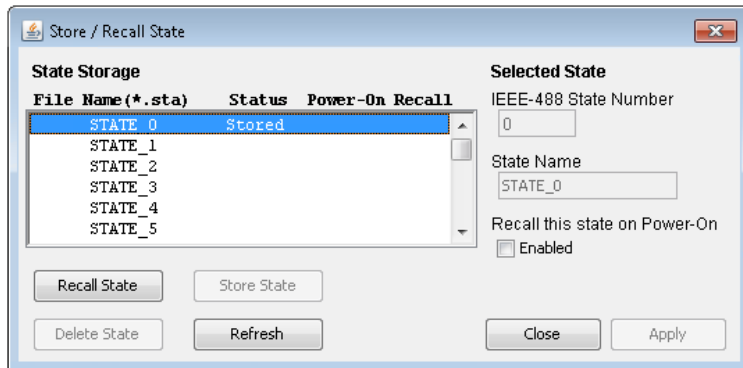

Commands

In the *Allow Full Control* mode, this window lets you interactively send commands to the DMM and read responses. You can use this to become familiar with the instrument's command set, and to rapidly prototype commands and check responses before writing code. Buttons on the right side of the window send a Device Clear, *RST, or send and read *IDN? or SYST:ERR?.

Use the **Enter SCPI command or query** field to enter SCPI commands and click **Send**, to execute the command, **Read** to read back a response, or **Send & Read** to execute the command and read back the response.

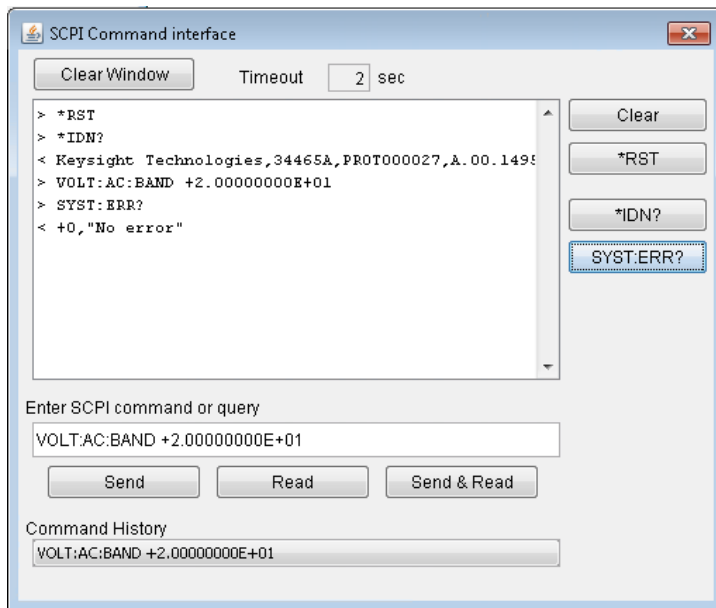

Run Autocal

In the *Allow Full Control* mode, click the **Run Autocal** button to perform an autocalibration (autocal). During the autocal, this button is grayed-out until the autocal is complete (typically 15 to 20 seconds).

Configuration Page

The Configuration page allows you to view the instrument's network configuration parameters, which configure the instrument to operate in your environment. To modify a parameter, click **Modify Configuration**.

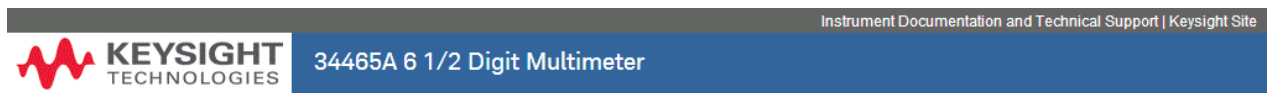

Configuration of your 34465A

Modify Configuration

Parameter	Currently in use
IP Address Configuration:	Automatic
IP Address:	169.254.4.61
Subnet Mask:	255.255.0.0
Default Gateway:	169.254.4.61
DNS Server(s):	
Desired Hostname	A-34465A-00027
Domain:	
Description:	Agilent 34465A Digital Multimeter - PROTO00027

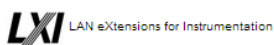



Help

Help is available for each of the tabs described above. For example:



34465A 6 1/2 Digit Multimeter

Configuration Page Help

The Configuration page allows you to view the instrument's network configuration parameters, which configure the instrument to operate in your environment. To modify a parameter, click **Modify Configuration**.

You may set or clear a password from the Modify Configuration page. The default is no password (disabled). If a password has been set, you will be prompted for it before going to the Modify Configuration and Browser Web Control pages.

The parameters on the Current Configuration page are:

- **IP Address Configuration**
If this is set to Automatic, the IP Address, Subnet Mask, and Default Gateway were determined automatically, either from DHCP or if a DHCP server was not found, from Dynamically Configured Link Local Addressing (Auto-IP). If it is set to Manual, the IP Address, Subnet Mask, and Default Gateway were set to the manually configured values.
- **IP Address**
This is used for TCP/IP communications with the instrument. The IP Address Configuration indicates how the address was determined.
- **Subnet Mask**
This parameter enables the instrument to determine whether an IP Address is on the same local subnet. When an address is on a different subnet, all packets must be sent to a gateway. The IP Address Configuration (above) indicates how the subnet mask was determined.
- **Default Gateway**
This is the IP address of the default gateway that allows the instrument to communicate with devices that are not on the local subnet. Packets that are destined for a device not on the local subnet, as determined by the subnet mask, are sent to the default gateway. The IP Address Configuration (above) indicates how the default gateway was determined.
- **DNS Server(s)**
These are the IP addresses of the Domain Name System (DNS) servers. The server provides a hostname for a given IP Address based on entries in its

Measurement Tutorial

Follow the suggestions in the sections below to achieve the greatest accuracy with Keysight Truevolt Series multimeters.

[Metrology](#)

[DC Measurement Considerations](#)

[Noise Rejection](#)

[Resistance Measurement Considerations](#)

[True RMS AC Measurements](#)

[Capacitance](#)

[Digitizing](#)

[Data Logging](#)

[Other Primary Measurement Functions](#)

[Level Triggering](#)

[High-Speed Measurements](#)

[Other Sources of Measurement Error](#)

Measurement Considerations

To achieve the greatest accuracy with the Keysight Truevolt Series multimeters, you must eliminate potential measurement errors. This chapter describes common errors and suggests ways to avoid them.

Metrology

The 34470A 7½-digit DMM is well-suited for high-accuracy metrology applications. Keysight has a number of application notes pertaining to maximizing measurement accuracy, such as:

Practical Tips for Optimizing Measurement Accuracy with your Digital Multimeter - This Web page has a number of links to application notes addressing DMM measurement errors and how to make temperature measurements.

Making Better Measurements with your Digital Multimeter - This Web page has a number of links to application notes addressing better RMS measurements, system cabling errors, DC, frequency, and period measurement errors, and AC voltage measurement errors.

Make Better AC Measurements with Your Digital Multimeter - Focuses on AC measurement accuracy.

Make Better RMS Measurements with Your Digital Multimeter - Focuses on RMS measurement accuracy.

Practical Temperature Measurements - A detailed tutorial describing how to make accurate temperature measurements.

Search www.keysight.com for application notes that address your measurement and accuracy needs.

DC Measurement Considerations

Thermal EMF Errors

Thermoelectric voltages are the most common error source in low-level DC voltage measurements. Thermoelectric voltages are generated by circuit connections using dissimilar metals at different temperatures. Each metal-to-metal junction forms a thermocouple that generates a voltage proportional to the junction temperature, as shown in the table below. You should minimize thermocouple voltages and temperature variations in low-level voltage measurements. The best connections use copper-to-copper crimped connections, as the DMM's input terminals are a copper alloy.

Copper to:	Approx. $\mu\text{V} / ^\circ\text{C}$
Cadmium-Tin Solder	0.2
Copper	<0.3
Gold	0.5
Silver	0.5
Brass	3
Beryllium Copper	5
Aluminum	5
Tin-Lead Solder	5
Kovar or Alloy 42	40
Silicon	500
Copper Oxide	1000

Loading Errors (DC Voltage)

Measurement loading errors occur when the resistance of the DUT is an appreciable percentage of the multimeter's input resistance, as shown below.

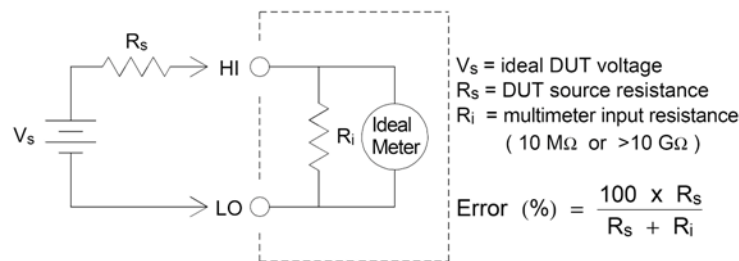

To reduce the effects of loading errors and to minimize noise pickup, set the multimeter's input resistance to >10 G Ω (high-impedance) for the 100 mVDC, 1 VDC, and 10 VDC ranges. The input resistance is maintained at 10 M Ω for the 100 VDC and 1000 VDC ranges.

Noise Rejection

Rejecting Power-Line Noise Voltages

A desirable characteristic of integrating analog-to-digital (A/D) converters is their ability to reject power-line related noise present with DC input signals. This is called normal mode noise rejection, or NMR. The multimeter achieves NMR by measuring the average DC input by "integrating" it over a fixed period. If you set the integration time to a whole number of power line cycles (PLCs), these errors (and their harmonics) will average out to approximately zero.

The multimeter provides three integration selections (1, 10, and 100 PLCs) that achieve NMR. The multimeter measures the power-line frequency (50 Hz or 60 Hz), and then determines the corresponding integration time. For a complete listing of NMR, approximate added rms noise, reading rate, and resolution for each integration setting, see the Performance vs. Integration Time table.

Common Mode Rejection (CMR)

Ideally, a multimeter is completely isolated from earth-referenced circuits. However, there is finite resistance between the multimeter's input LO terminal and earth ground, as shown below. This can cause errors when measuring low voltages which are floating relative to earth ground.

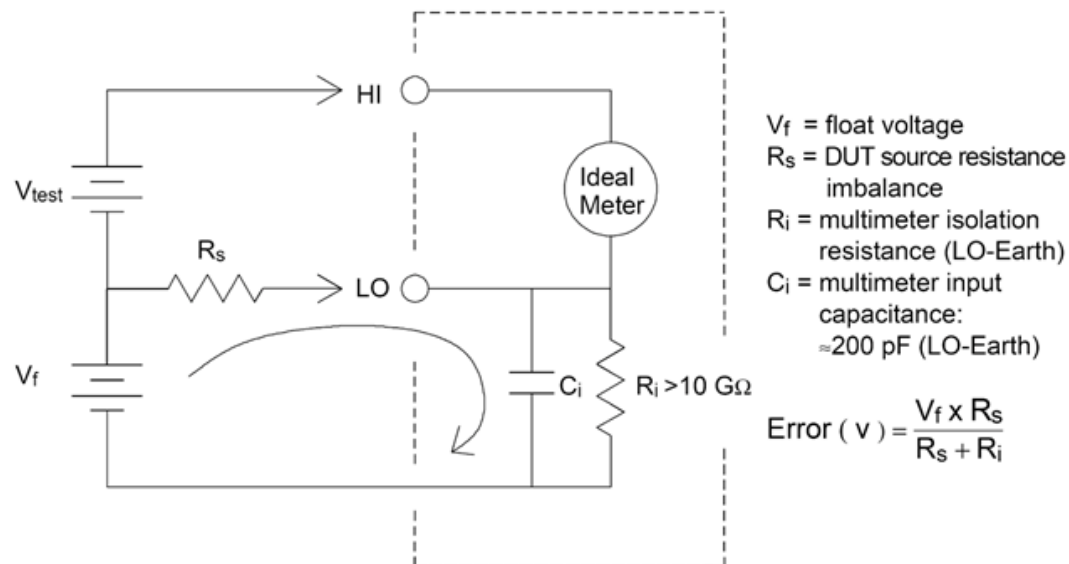

Noise Caused by Magnetic Loops

When making measurements near magnetic fields, avoid inducing voltages in the measurement connections. You should be especially careful when working near conductors carrying large currents. Use twisted-pair connections to the multimeter to reduce the noise pickup loop area, or dress the test leads as close together as possible. Loose or vibrating test leads will also induce error voltages. Tie down test leads securely when operating near magnetic fields. Whenever possible, use magnetic shielding materials or increased distance from magnetic sources.

Noise Caused by Ground Loops

When measuring voltages in circuits where the multimeter and the DUT are referenced to a common earth ground, a "ground loop" is formed. As shown below, any voltage difference between the two ground reference points (V_{ground}) causes current to flow through the measurement leads. This causes noise and offset voltage (usually power-line related), which are added to the measured voltage.

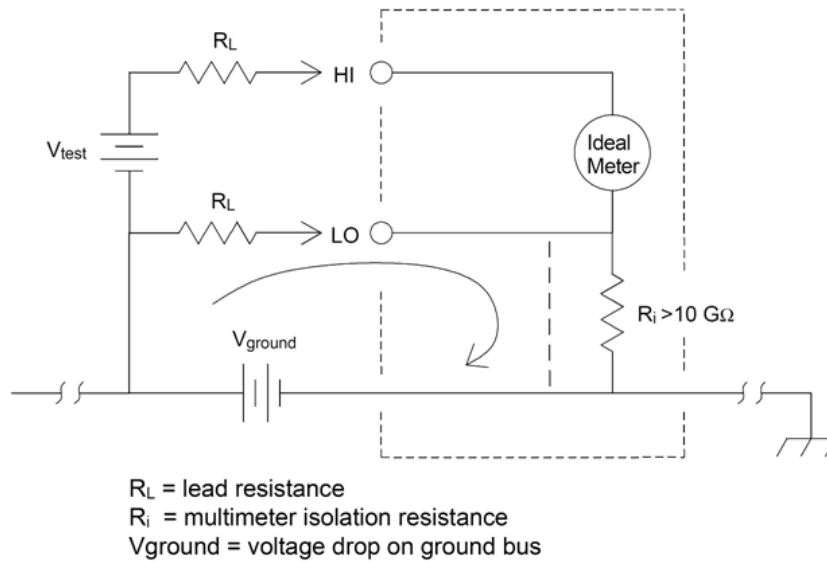

The best way to eliminate ground loops is to isolate the multimeter from earth by not grounding the input terminals. If the multimeter must be earth-referenced, connect it and the DUT to one common ground point. Also connect the multimeter and DUT to the same electrical outlet whenever possible.

Resistance Measurement Considerations

The multimeter offers two resistance measurements: 2-wire and 4-wire ohms. For both methods, the test current flows from the input HI terminal, through the resistor being measured. For 2-wire ohms, the voltage drop across the resistor being measured is sensed internal to the multimeter. Therefore, test lead resistance is also measured. For 4-wire ohms, separate "sense" connections are required. Because no current flows in the sense leads, the resistance in these leads does not give a measurement error.

NOTE The errors mentioned earlier in this chapter for DC voltage measurements also apply to resistance measurements. Additional error sources unique to resistance measurements are discussed below.

The 4-wire ohms method provides the most accurate way to measure small resistances because it reduces test lead and contact resistances. This is often used in automated test applications where resistive and/or long cable, numerous connections, or switches exist between the multimeter and the DUT. The recommended connections for 4-wire ohms measurements are shown below.

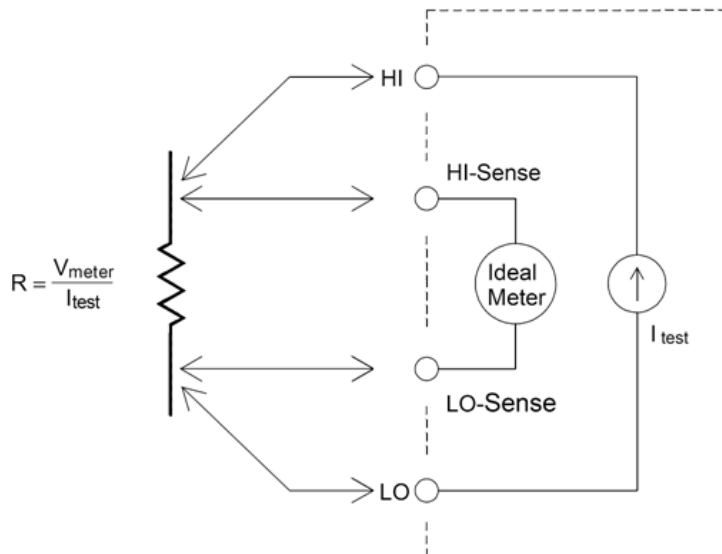

For the 34465A and 34470A, you can also enable offset compensated resistance measurements using `[SENSe:]{RESistance|FRESistance}:OCOMpensated {OFF|ON}`. Offset compensation removes the effects of small dc voltages in the circuit being measured. The technique involves taking the difference between two resistance measurements, one with the current source set to the normal value, and one with the current source set to a lower value.

Removing Test Lead Resistance Errors

To eliminate offset errors associated with test lead resistance in 2-wire ohms measurements, follow these steps:

Short the test lead ends together and read the displayed test lead resistance.

Press **Null**. The multimeter will store the test lead resistance as the 2-wire ohms null value, and subtract that value from subsequent measurements.

See also "Null Measurements."

Minimizing Power Dissipation Effects

When measuring resistors designed for temperature measurements (or other resistive devices with large temperature coefficients), be aware that the multimeter will dissipate some power in the DUT. The following table shows several examples.

Range	Standard Test Current	Power Dissipation in DUT
1 G Ω	500 nA	2.5 μ W
100 M Ω	500 nA	2.5 μ W
10 M Ω	500 nA	2.5 μ W
1 M Ω	5 μ A	25 μ W
100 k Ω	10 μ A	10 μ W
10 k Ω	100 μ A	100 μ W
1 k Ω	1 mA	1 mW
100 Ω	1 mA	100 μ W

If power dissipation is a problem, you should select a higher fixed range (all multimeter models) or, for the 34465A/70A, select the low power resistance measurement mode (see **Resistance** (front panel), or **[SENSe:]{RESistance|FRESistance}:POWer:LIMit[:STATe]** (remote)). The low power mode sources less test current per measurement range than is normally sourced for standard resistance measurements, to reduce power dissipation and self-heating in the DUT. The following table shows the various resistance ranges, the standard test current delivered for 2- and 4-wire resistance measurements, and the low power mode test current.

Range	Standard Test Current	Low Power Mode Test Current
1 G Ω	500 nA	500 nA
100 M Ω	500 nA	500 nA
10 M Ω	500 nA	500 nA
1 M Ω	5 μ A	5 μ A
100 k Ω	10 μ A	5 μ A
10 k Ω	100 μ A	10 μ A
1 k Ω	1 mA	100 μ A
100 Ω	1 mA	100 μ A



Errors in High Resistance Measurements

When you are measuring large resistances, significant errors can occur due to insulation resistance and surface cleanliness. You should take the necessary precautions to maintain a "clean" high-resistance system. Test leads and fixtures are susceptible to leakage due to moisture absorption in insulating materials and "dirty" surface films. Nylon and PVC are relatively poor insulators ($10^9 \Omega$) when compared to PTFE insulators ($10^{13} \Omega$). Leakage from nylon or PVC insulators can easily contribute a 0.1% error when measuring a 1 M Ω resistance in humid conditions.

True RMS AC Measurements

True rms responding multimeters, like the Keysight Truevolt Series, measure the "heating" potential of an applied voltage. Power dissipated in a resistor is proportional to the square of an applied voltage, independent of the waveshape of the signal. This multimeter accurately measures true rms voltage or current, as long as the wave shape contains negligible energy above the meter's effective bandwidth.

The Keysight Truevolt Series uses the same techniques to measure true rms voltage and true rms current. The effective AC voltage bandwidth is 300 kHz, while the effective AC current bandwidth is 10 kHz.

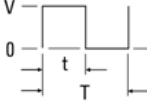
Waveform Shape	Crest Factor (C.F.)	AC RMS	AC + DC RMS	Average Responding Error
	1.414	$\frac{V}{1.414}$	$\frac{V}{1.414}$	Calibrated for 0 error
	1.732	$\frac{V}{1.732}$	$\frac{V}{1.732}$	-3.9%
	$\sqrt{\frac{T}{t}}$	$\frac{V}{C.F.} \times \sqrt{1 - \left(\frac{1}{C.F.}\right)^2}$	$\frac{V}{C.F.}$	-46% for C.F. = 4

The DMM's AC voltage and AC current functions measure the AC-coupled true rms value. In this DMM, the "heating value" of only the AC components of the input waveform are measured (dc is rejected). As seen in the figure above; for sine waves, triangle waves, and square waves, the AC-coupled and AC+DC values are equal, because these waveforms do not contain a DC offset. However, for non-symmetrical waveforms (such as pulse trains) there is a DC voltage content, which is rejected by Keysight's AC-coupled true rms measurements. This can provide a significant benefit.

An AC-coupled true rms measurement is desirable when you are measuring small AC signals in the presence of large DC offsets. For example, this situation is common when measuring AC ripple present on DC power supplies. There are situations, however, where you might want to know the AC+DC true rms value. You can determine this value by combining results from DC and AC measurements, as shown below:

$$ac + dc = \sqrt{ac^2 + dc^2}$$

For the best AC noise rejection, you should perform the DC measurement using an integration time of at least 10 power-line cycles (PLCs).

True RMS Accuracy and High-Frequency Signal Content

A common misconception is that because an AC multimeter is true rms, its sine wave accuracy specifications apply to all waveforms. Actually, the shape of the input signal dramatically affects measurement accuracy for any multimeter, especially when that input signal contains high-frequency the instrument's bandwidth.

For example, consider a pulse train, one of the most challenging waveforms for a multimeter. The pulse width of that waveform largely determines its high-frequency content. The frequency spectrum of an individual pulse is determined by its Fourier Integral. The frequency spectrum of the pulse train is the Fourier Series that samples along the Fourier Integral at multiples of the input pulse repetition frequency (prf).

The figure below shows the Fourier Integral of two very different pulses: one of broad width (200 μs); the other narrow (6.7 μs). The bandwidth of the ACV path in the DMM is 300 kHz; therefore, frequency content above 300 kHz is not measured.

Notice that the $\frac{\sin(\pi f T)}{\pi f T}$ spectrum of the narrow pulse significantly exceeds the effective bandwidth of the instrument. The net result is a less accurate measurement of the narrow, high-frequency pulse.

In contrast, the frequency spectrum of the broad pulse has fallen off significantly below the multimeter's 300 kHz (approximately) bandwidth, so measurements of this pulse are more accurate.

Reducing the prf increases the density of lines in the Fourier spectrum, and increases the portion of the input signal's spectral energy within the multimeter's bandwidth, which improves accuracy.

In summary, error in rms measurements arise when there is significant input signal energy at frequencies above the multimeter's bandwidth.

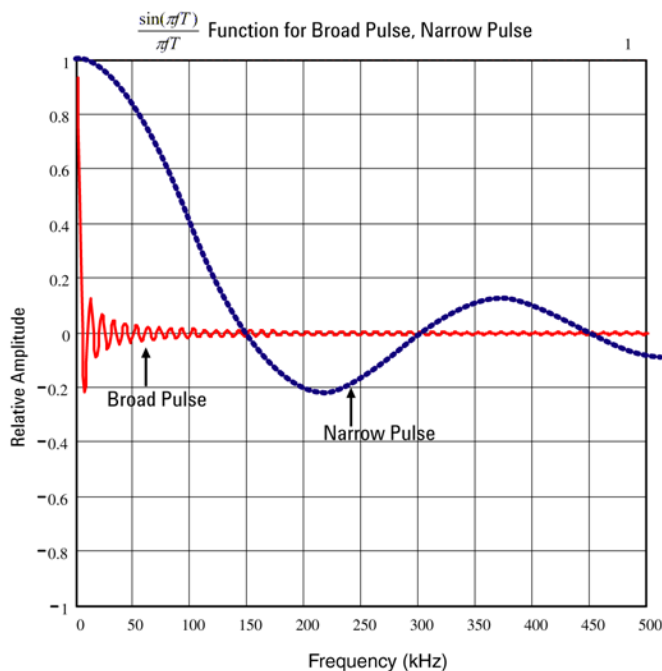

Estimating High-Frequency (Out-of-Band) Error

A common way to describe signal waveshapes is to refer to their "Crest Factor". Crest factor is the ratio of the peak value to rms value of a waveform. For a pulse train, for example, the crest factor is approximately equal to the square root of the inverse of the duty cycle.

$$CF = \frac{1}{\sqrt{d}} = \frac{1}{\sqrt{\frac{t_p}{T}}} = \frac{1}{\sqrt{prf \times t_p}}$$

Notice that crest factor is a composite parameter, dependent upon the pulse width and repetition frequency; crest factor alone is not enough to characterize the frequency content of a signal.

Traditionally, DMMs include a crest factor derating table that applies at all frequencies. The measurement algorithm used in the Truevolt Series DMMs is not inherently sensitive to crest factor, so no such derating is necessary. With this multimeter, as discussed in the previous section, the focal issue is high-frequency signal content which exceeds the multimeter's bandwidth.

For periodic signals, the combination of crest factor and repetition rate can suggest the amount of high-frequency content and associated measurement error. The first zero crossing of a simple pulse occurs at $f_1 = 1/t_p$.

This gives an immediate impression of the high-frequency content by identifying where this crossing occurs as a function of crest factor: $f_1 = (CF^2)(prf)$.

The following table shows the typical error for various pulse waveforms as a function of input pulse frequency:

Typical error for square wave, triangle wave, and pulse trains of CF=3, 5, or 10					
prf	square wave	triangle	CF=3	CF=5	CF=10
200	-0.02%	0.00%	-0.04%	-0.09%	-0.34%
1000	-0.07%	0.00%	-0.18%	-0.44%	-1.71%
2000	-0.14%	0.00%	-0.34%	-0.88%	-3.52%
5000	-0.34%	0.00%	-0.84%	-2.29%	-8.34%
10000	-0.68%	0.00%	-1.75%	-4.94%	-26.00%
20000	-1.28%	0.00%	-3.07%	-8.20%	-45.70%
50000	-3.41%	-0.04%	-6.75%	-32.0%	-65.30%
100000	-5.10%	-0.12%	-21.8%	-50.6%	-75.40%

This table gives an additional error for each waveform, to be added to the value from the accuracy table provided in the instrument's data sheet

The specifications are valid for $CF \leq 10$, provided there is insignificant signal energy above the 300 kHz bandwidth for voltage, or the 10 kHz bandwidth for current. Multimeter performance is not specified for $CF > 10$, or when significant out-of-band signal content is present.

Example

A pulse train with level 1 V_{rms}, is measured on the 1 V range. It has pulse heights of 3 V (that is, a Crest Factor of 3) and duration 111 μs. The prf can be calculated to be 1000 Hz, as follows:

$$prf = \frac{1}{CF^2 \times t_p}$$

Thus, from the table above, this AC waveform can be measured with 0.18 percent additional error.

Other Primary Measurement Functions

Frequency and Period Measurement Errors

The multimeter uses a reciprocal counting technique to measure frequency and period. This method generates constant measurement resolution for any input frequency. The multimeter's AC voltage measurement section performs input signal conditioning. All frequency counters are susceptible to errors when measuring low-voltage, low-frequency signals. The effects of both internal noise and external noise pickup are critical when measuring "slow" signals. The error is inversely proportional to frequency. Measurement errors also occur if you attempt to measure the frequency (or period) of an input following a DC offset voltage change. You must allow the multimeter's input DC blocking capacitor to fully settle before making frequency measurements.

DC Current

When you connect the multimeter in series with a test circuit to measure current, a measurement error is introduced. The error is caused by the multimeter's series burden voltage. A voltage is developed across the wiring resistance and current shunt resistance of the multimeter, as shown below.

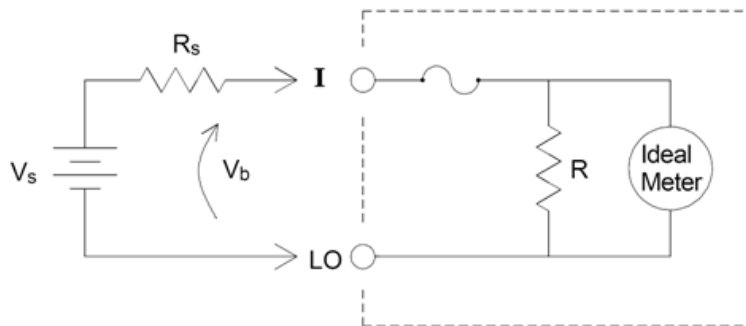

V_s = source voltage
 R_s = DUT source resistance
 V_b = multimeter burden voltage
 R = multimeter current shunt

$$\text{Error (\%)} = \frac{-100\% \times V_b}{V_s}$$

Avoid applying signals to unused current input terminals

If signal inputs are applied to terminals not needed for the current measurement, measurement errors may occur. The unused terminals are still protected but the un-needed signals may interfere with current measurement. For example, applying inputs to the 3A terminals while making measurements on the 10A terminals will typically cause errors.

The Hi and Lo sense terminals are not used for many measurements. Applying signals here when not needed can also cause errors. AC or DC voltages above 15 volts peak on the un-needed sense terminals are likely to cause measurement errors. If unexpected errors are occurring, signals on the un-needed terminals is an area to check.

NOTE

34465A/34470A DMMs with serial number MY59018001 and above will have the hardware design that allows simultaneous connections.

Temperature Measurements

Temperature measurements require a temperature transducer probe. The supported probes are 2-wire and 4-wire RTDs, 2-wire and 4-wire thermistors (2.2 k Ω 44004 type, 5 k Ω 44007 type and 10 k Ω 44006 type, see Thermistor Requirements below), and, for the 34465A/70A only, type E, J, K, N, R, or T thermocouples.

Probe Type Choice

RTD's provide very accurate, highly linear relationships between resistance and temperature, over a range of roughly -200 to 500 $^{\circ}\text{C}$. There is very little conversion complexity for an RTD because it is so intrinsically linear. The multimeter provides measurement for the IEC751 standard RTD, which has a sensitivity of $0.385\%/^{\circ}\text{C}$.

Thermistors consist of semiconductor materials, and provide roughly ten times the sensitivity of the RTD. Because they are semiconductors, their temperature range is more limited, commonly to -80 to 150 $^{\circ}\text{C}$. Thermistors have highly non-linear temperature-resistance relationships; therefore their conversion algorithms are more complex. The Truevolt Series multimeters use the standard Hart-Steinhart Approximation to provide accurate conversions, with a typical resolution of $.08$ $^{\circ}\text{C}$.

Thermistor Requirements

The DMM converts the measured thermistor resistance to temperature using the Steinhart-Hart thermistor equation:

$$1/T = A + B (\ln(R)) + C (\ln(R))^3$$

Where:

A, B, and C are constants provided by the thermistor manufacturer and derived from three temperature test points.

R = Thermistor resistance in Ω .

T = Temperature in degrees K.

Important: Use only a 2.2 k Ω 44004 type, 5 k Ω 44007 type or 10 k Ω 44006 type thermistor. Using an incorrect type of thermistor can result in errors greater than 20 $^{\circ}\text{C}$ for a temperature being measured of 100 $^{\circ}\text{C}$.

For a detailed tutorial on temperature measurements, refer to Keysight Application Note 290 *Practical Temperature Measurements* available at www.keysight.com.

2-Wire vs. 4-Wire Measurements

As with resistance measurements, four-wire temperature measurements are more accurate, because errors due to lead wire resistance are completely eliminated. Alternately, you can use the multimeter's Null function to remove the test lead resistance from the measurement (see NULL Reading below).

NULL Reading

The DMM allows a separate null setting to be saved for the temperature function. When making null measurements, each reading is the difference between a stored null value and the input signal. One application of NULL is to increase accuracy of two-wire resistance measurements by first nulling the closed-circuit test lead resistance.

Autozero On/Off

Enabling the autozero feature (ON) provides greater accuracy; however, the additional measurement (of zero) reduces the reading speed.

Making High-Speed AC Measurements

The multimeter's AC voltage and AC current functions implement three low-frequency filters. These filters allow you to trade-off minimum measured frequency for faster reading speed. The FAST filter settles in 0.025 seconds, and is useful for frequencies above 200 Hz. The MEDIUM filter settles in 0.625 seconds for voltage and 0.25 seconds for current, and is useful for measurements above 20 Hz. The SLOW filter settles in 2.5 seconds for voltage and 1.66 seconds for current, and is useful for frequencies above 3 Hz.

With a few precautions, you can perform AC measurements at speeds up to 500 readings per second. Use manual ranging to eliminate autoranging delays. By setting the trigger delay to 0, the FAST, MEDIUM, and SLOW filters allow up to 500, 150, and 50 readings per second, but with reduced accuracy because the filter may not fully settle. If the sample-to-sample levels are similar, little settling time is required for each new reading. Under this specialized condition, the MEDIUM filter provides reduced accuracy results at 20 readings per second, and the FAST filter provides reduced accuracy results at 200 readings per second.

AC Filter	Filter Bandwidth	Settling Time (s)		Full Settling (rdg-s/s)		Partial Settling	Maximum rdg-s/s
		ACV	ACI	ACV	ACI	ACV/ACI	ACV/ACI
Slow	3 Hz	2.5	1.67	0.4	0.6	2	50
Medium	20 Hz	0.63	0.25	1.6	4	20	150
Fast	200 Hz	0.025	0.025	40	40	200	500

In applications where sample-to-sample levels vary widely, but the DC offset level does not change, the MEDIUM filter settles at 2 to 4 readings per second (depending upon the lowest frequency component in the waveform) as shown in the following table:

Lowest Frequency Component	20 Hz	50 Hz	100 Hz	200 Hz
AC Current (allowable rate in rdgs/s)	4	4	4	4
AC Voltage (allowable rate in rdgs/s)	2	3	4	4

For AC voltage, additional settling time may be required when the DC level varies from sample to sample. The default sample delays allow for a DC level change of 3% of range for all filters. If the DC level change exceeds these levels, additional settling time is required. The multimeter's DC blocking circuitry has a settling time constant of 0.2 seconds. This settling time only affects measurement accuracy when DC offset levels vary from sample to sample. If maximum measurement speed is desired, you may want to add an

external DC blocking circuit for circuitry with significant DC voltages present. This circuit can be as simple as a resistor and a capacitor.

For AC current, additional settling time is not required when the DC level varies sample to sample.

Making High-Speed DC and Resistance Measurements

If you have the DIG (digitizing) option, simply select **[Acquire] > Digitize** to select the fastest DCV or DCI measurements. If you do not have the DIG option, or for resistance measurements, to make the fastest (but least accurate) DC or resistance measurements:

- Set the integration time (NPLC or aperture) to minimum
- Select a fixed range (autorange off)
- Disable autozero
- Disable offset compensation (resistance measurements)

Refer to the particular measurement type in **Measurements** for more information on the above functions.

Capacitance

The multimeter makes capacitance measurements by applying a known current to charge the capacitance and then a resistance to discharge as shown below:

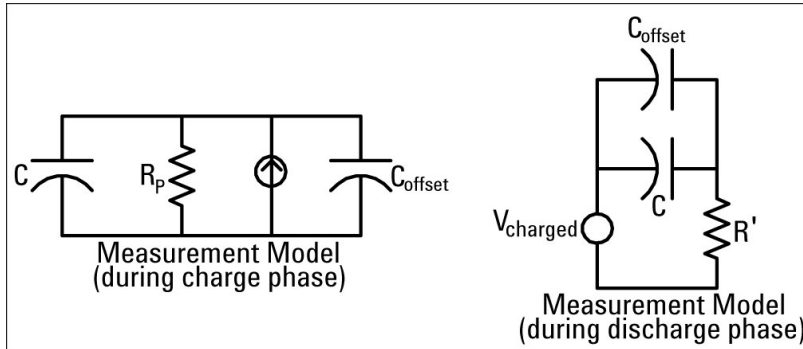

An illustration of the response curve while charging is shown below:

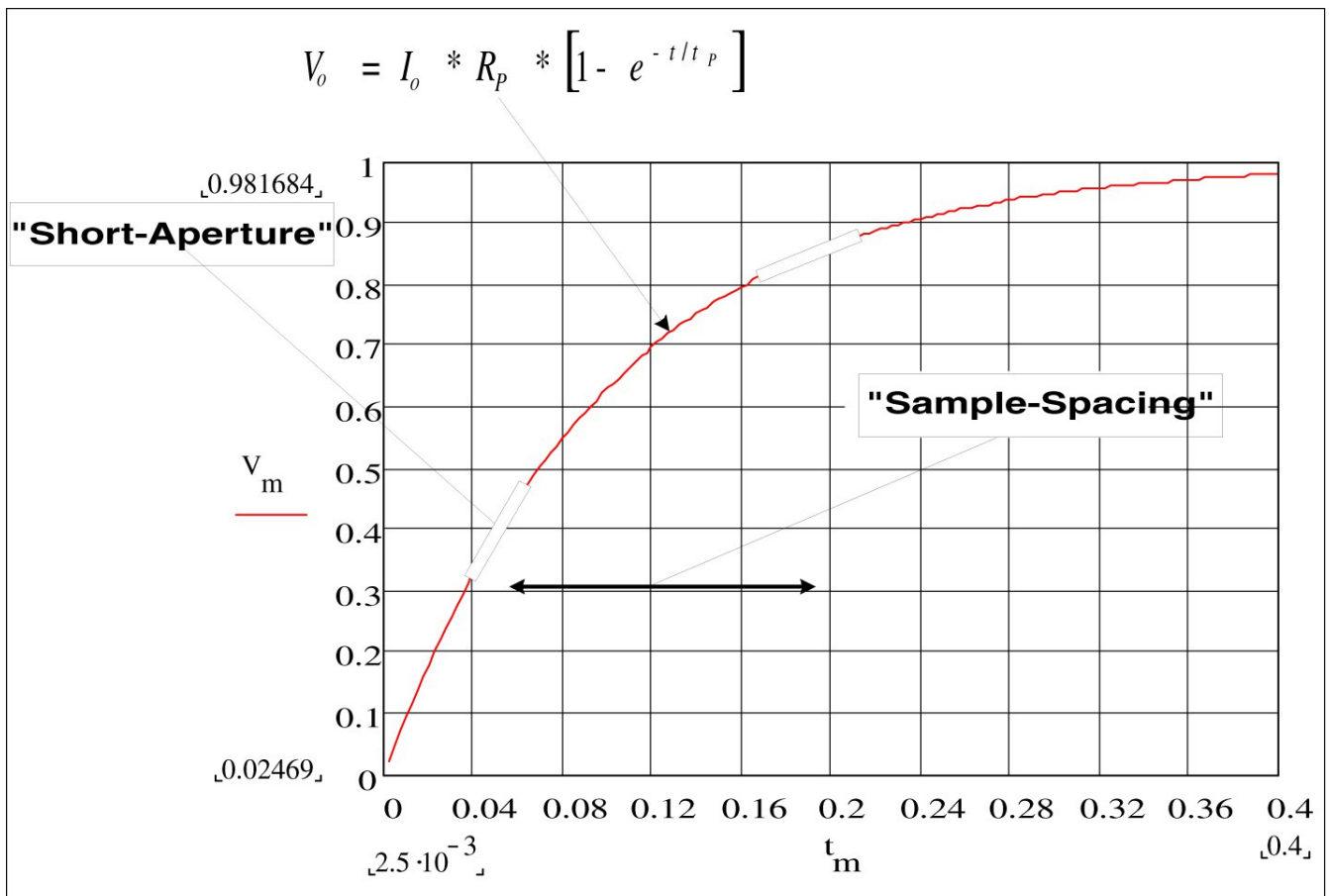

Capacitance is calculated by measuring the change in voltage (DV) that occurs over a “short aperture” time, (Dt). This measurement is repeated at two different times during the exponential rise that occurs. An algorithm takes the data from these four points, and by linearizing that exponential rise over these “short apertures”, accurately calculates the capacitance value.

The measurement cycle consists of two parts: a charge phase (shown in the graph) and a discharge phase. The time-constant during the discharge phase is longer, due to a 100 k Ω protective resistor in the measurement path. This time-constant plays an important role in the resultant reading rate (measurement time). The incremental times (or “sample times”) as well as the width of the “short apertures”, vary by range, in order to minimize noise and increase reading accuracy.

For the best accuracy, take a zero null measurement with open probes, to null out the test lead capacitance, before connecting the probes across the capacitor to be measured (see [Capacitance Measurements](#) for details).

Capacitance Measurement Considerations

Capacitors that have a high dissipation factor or other non-ideal characteristics will affect capacitance measurements. Capacitors with high dissipation factors may exhibit a variance between the measured value using the multimeter versus the single frequency method of some other LCR meters. The single frequency method will also see more variation at different frequencies. For example, some inexpensive capacitance substitution boxes, when measured with the multimeter, are almost 5% different compared to the same capacitance measured with the single frequency method of an LCR meter. The LCR meter will also show different values at different frequencies.

Capacitors with long time constants (dielectric absorption) will result in slow measurement settling time, and will take a number of seconds to stabilize. You may see this when first connecting a capacitor or when the delay time to make a measurement is varied. A high quality film capacitor typically shows the least of this and an electrolytic capacitor the most, with ceramic capacitors typically in between.

Digitizing Measurements

The digitize mode applies only to the 34465A/70A with the DIG option, and as is available only from the DMM's front panel. The digitized mode provides a front-panel user interface that allows you to quickly set up digitized measurements.

Digitizing is the process of converting a continuous analog signal, such as a sine wave, into a series of discrete samples (readings). The figure below shows the result of digitizing a sine wave. This chapter discusses the various ways to digitize signals. The importance of the sampling rate, and how to use level triggering.

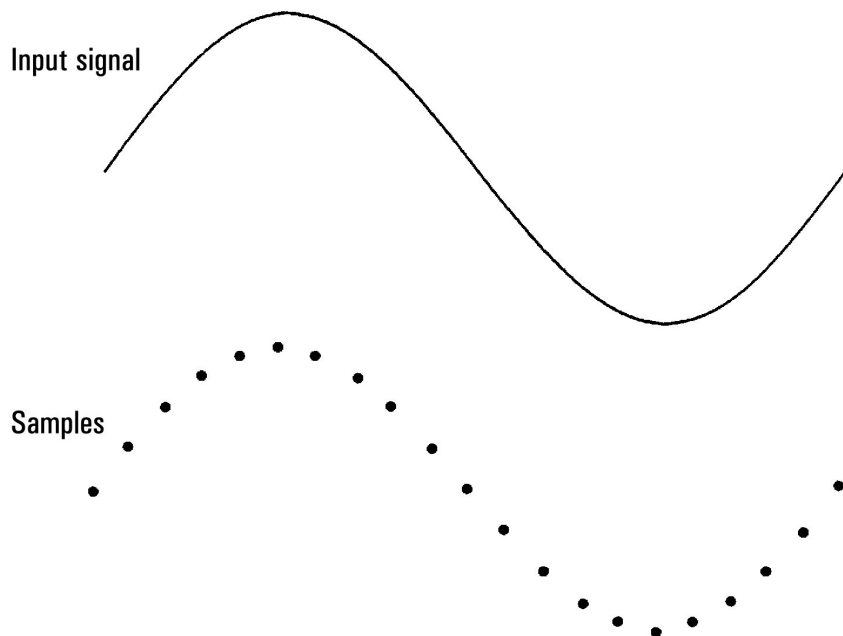

The Sampling Rate

The Nyquist or Sampling Theorem states: *If a continuous, bandwidth-limited signal contains no frequency components higher than F , then the original signal can be recovered without distortion (aliasing) if it is sampled at a rate that is greater than $2F$ samples per second.*

In practice, the multimeter's sampling rate must be greater than twice the highest frequency component of the signal being measured. From the front panel you can select a sample rate in samples per second using the **Sample Rate** softkey. You can also set the sample rate indirectly by specifying the sample interval (the time from the beginning of one sample to the beginning of the next sample) using the **Sample Interval** softkey.

The figure below shows a sine wave sampled at a rate slightly less than $2F$. As shown by the dashed line, the result is an alias frequency which is much different than the frequency of the signal being measured. Some digitizers have a built-in anti-aliasing low-pass filter with a sharp cutoff at a frequency equal to $1/2$ the digitizer's sampling rate. This limits the bandwidth of the input signal so that aliasing cannot occur. Since the multimeter has a variable sample rate for DCV digitizing, and to preserve the upper bandwidth

for high-frequency measurements, no anti-aliasing filter is provided in the multimeter. If you are concerned about aliasing, you should add an external anti-aliasing filter.

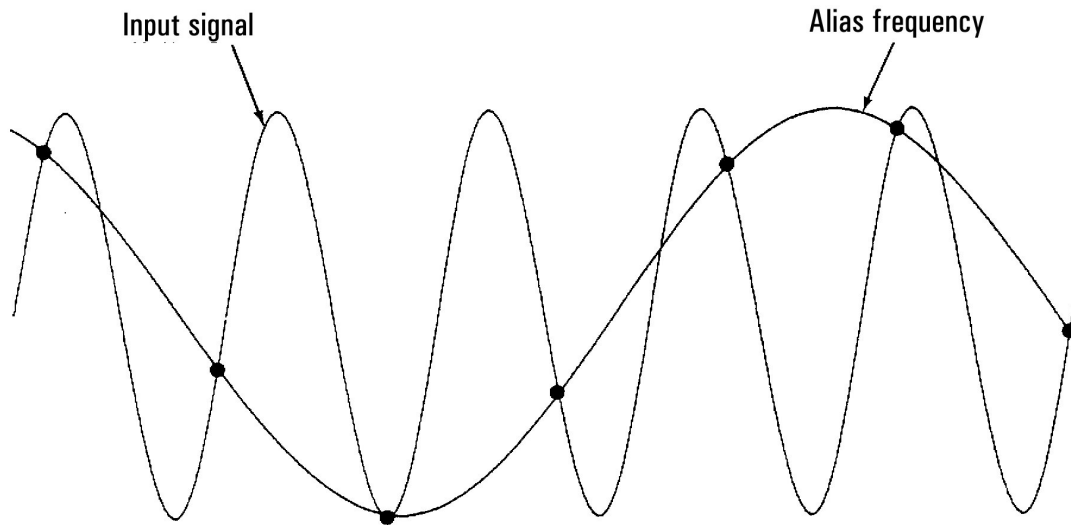

Level Triggering

When digitizing, it is important to begin sampling at some defined point on the input signal such as when the signal crosses zero volts or when it reaches the midpoint of its positive or negative peak amplitude. Level triggering allows you to specify when (with respect to voltage and slope) to begin sampling. Refer to [Level Triggering](#) for more information.

About Digitize Mode

- Digitizing is available only for the 34465A/70A and requires the DIG option.
- Digitizing allows you to take samples of the input signal, at a specified Sample Rate (for example, 50 kHz) or Sample Interval (for example, 20 μ S). You can specify the Duration as either an amount of Time or a number of Readings (samples). You can use either auto, external, or level triggering. After pressing **[Acquire]**, press **Acquire > Digitize**. You can then select the digitizing/triggering parameters. After configuring the digitizing parameters, press **[Run/Stop]**. Digitizing will begin when the specified trigger event occurs.
- Digitize mode is available only from the front panel and can only be used for DCV or DCI measurement functions.
- When you specify digitizing settings that conflict with present settings, the instrument displays a message, and in most cases, adjusts settings to legal values. For example, if you configure digitizing for a greater sample rate than can be achieved with the present integration time (NPLC setting), the instrument displays a message and reduces the integration time. When you see a displayed message, such as *NPLC setting reduced to achieve digitize rate/interval*, you can press **Shift > Help > 1 View the last message displayed > Select** to view more information.
- The DIG option increases the maximum reading rates from 5k readings/s (standard) to 50k readings/s (maximum).

- The DIG option enables pretriggering, level triggering, and trigger delay capability.
- With the DIG option, level triggering, pretriggering, and sample timer capabilities are enabled when using the DMM from remote. From the front panel, level trigger is available for digitizing and for certain measurement functions in continuous mode (see [Level Triggering](#) for more information). Pretrigger front panel controls are only available in the digitize mode. The sample timer controls are available from the front panel for all measurement modes.
- For pretrigger, if a trigger comes before all pretriggers are received, trigger is executed to begin readings.
- While digitizing, **Digitizing** flashes near the top of the display. When stopped, **Digitize Stopped** is displayed. While digitizing, the remaining time and remaining samples are displayed near the bottom of the display.



- All samples taken during digitizing are saved in volatile memory. After completing a digitize operation, press the **Save Readings** softkey and specify a file to save the digitized readings to a file.
- The maximum number of readings that can be captured is based on volatile memory space available.
- Reading store is cleared at the start of a new acquisition.
- The slowest sample rate for digitizing is 20 ms (1 PLC); the fastest is 19.953 μ s/50.118 kHz (.001 PLC).
- Any display mode can be set to view data during acquisition but responsiveness to data views may not respond until data acquisition is complete. After acquisition is complete – trend chart pan, zoom, and cursors can be used to review data.
- Statistics and histogram data are calculated after the digitizing is completed.

Data Log and Digitizing Local Remote Interaction

CAUTION

Loss of data possible - local to remote transition clears instrument memory: When data logging or digitizing to *memory*, if you access the instrument from remote (send a SCPI or common command)* and then return to local (by pressing [**Local**]), the readings in memory are cleared and the instrument returns to Continuous mode.

For data logging only, you can prevent this situation by data logging to a file instead of to memory (see **Data Log Mode** for details). You can also prevent this from happening for data logging or digitizing by taking steps to keep the instrument from being accessed from remote. To prevent remote access, you may want to disconnect the LAN, GPIB, and USB interface cables from the instrument before starting the measurements. To prevent remote access via LAN, you can connect the instrument behind a router to minimize the possibility of remote access. You can also disable the various I/O interfaces from the front panel menus under [**Utility**] > **I/O Config**.

To view the status of a data logging or digitizing operation remotely, use the instrument's **Web User Interface**. The Web User Interface monitor does not set the instrument to remote.

**When accessed from remote, the instrument will continue data logging or digitizing to completion, and you can retrieve the readings from remote.*

Data Log Mode

The Data Log mode is standard on the 34465A and 34470A only, as is available only from the DMM's front panel. Data Log mode provides a front-panel user interface that allows you to set up data logging into the instrument's non-volatile memory, or to internal/external file(s), without programming, and without a connection to a computer. Once you have finished collecting data, you can view it from the front panel, or you can transfer the data to your computer. Data Log mode allows you to log a specified number of readings, or readings acquired for a specified period of time, to instrument memory or to internal or external data files.

To select Data Log mode, press **[Acquire] Acquire > Data Log**. You can then select the Sample Interval (time between measurements - for example, 500 ms), Duration as either an amount of Time or a number of Readings, whether to Start after a Delay or at a specific Time of Day, and whether to Log to Memory or Log to File(s). After configuring the data logging parameters, press **[Run/Stop]**. Data logging will begin following the specified Delay or at the specified Time of Day.

CAUTION

Loss of data possible - local to remote transition clears instrument memory: When data logging or digitizing *to memory*, if you access the instrument from remote (send a SCPI or common command)* and then return to local (by pressing **[Local]**), the readings in memory are cleared and the instrument returns to Continuous mode.

For data logging only, you can prevent this situation by data logging to a file instead of to memory (see [Data Log Mode](#) for details). You can also prevent this from happening for data logging or digitizing by taking steps to keep the instrument from being accessed from remote. To prevent remote access, you may want to disconnect the LAN, GPIB, and USB interface cables from the instrument before starting the measurements. To prevent remote access via LAN, you can connect the instrument behind a router to minimize the possibility of remote access. You can also disable the various I/O interfaces from the front panel menus under **[Utility] > I/O Config**.

To view the status of a data logging or digitizing operation remotely, use the instrument's [Web User Interface](#). The Web User Interface monitor does not set the instrument to remote.

**When accessed from remote, the instrument will continue data logging or digitizing to completion, and you can retrieve the readings from remote.*

Data Log Mode Features

- The Data Log mode is available for DC voltage, DC current, AC voltage, AC current, 2-wire and 4-wire resistance, frequency, period, temperature, capacitance, and ratio measurements. The Data Log mode is not available for the continuity or diode functions.
- The maximum data log rate is 1000 readings/sec. Note: The maximum reading rate may be limited by settings already configured when entering data log mode (particularly NPLC settings for DC and resistance measurements). In this situation, press the measurement function key (for example, DCV) and decrease the aperture setting (either NPLC or Time).

- Data Log mode settings and measurement settings interact. These include the sample interval, destination (memory or file), measurement function, NPLC, Aperture, Autorange, Autozero, Offset Compensation, AC Filter, TC Open Check, and Gate Time. When you specify data log settings that conflict with present settings, the instrument displays a message, and in most cases, adjusts settings to legal values. For example, if you configure data logging for more readings than can be saved to reading memory, the instrument displays a message and reduces the maximum number of readings. When you see a displayed message, such as *The data logging Sample Interval increased*, you can press **Shift > Help > 1 View the last message displayed > Select** to view more information.
- The maximum data logging duration is 100 hours, the minimum is 1 second.
- By default, data logging implements auto trigger. The level and external trigger sources are not supported for data logging.
- When the data log mode is running, **Data Logging** flashes near the top of the display, and the log file path (when data logging to a file) remaining time, and remaining samples is displayed near the bottom of the display.

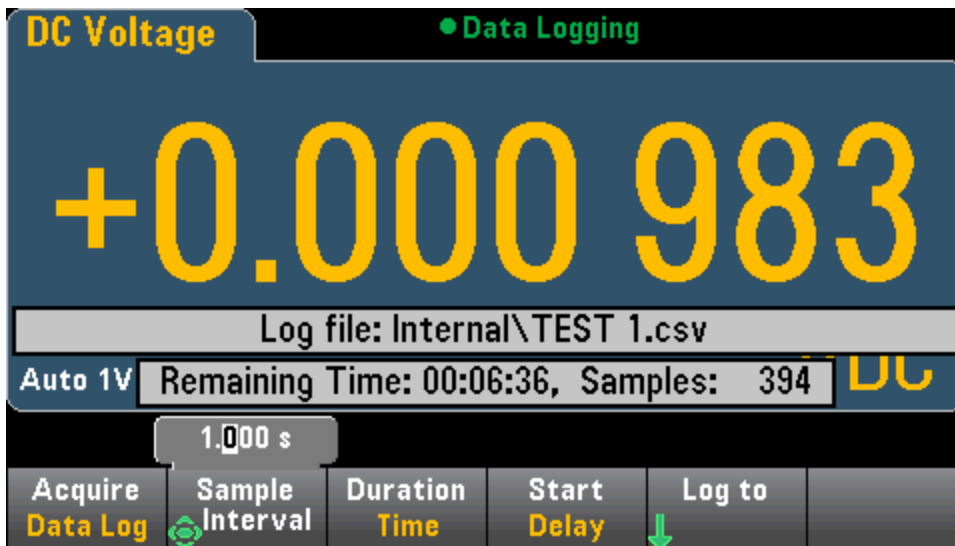

- You can store data logging readings in volatile memory for display or write the readings to one or more files.
- When data logging to memory, the data is volatile (not remaining during power off) but can be saved to an internal or external file after data logging is complete. The number of readings you can store in memory depends on the MEM option. With the MEM option, the limit is 2,000,000 readings. Without the MEM option, the limit is 50,000 readings.
- When data logging to file(s):
 - You can append the data logging start date and time to the file name using the format: `_YYYYMMDD_HHMMSS`. For example, for a file named *Data*, the result will be similar to *Data_20140720_032542.csv*.
 - You specify internal or external and a file name. If more than one file needs to be created to hold the data, the second filename will be appended with `_00001`, the third filename with `_00002`, and so on. When data logging to files, the maximum number of readings you can data log to files is $100 \text{ hours} \times 1000 \text{ rdgs/sec} = 360,000,000$.

- As shown in the sample data file graphic below, when **Metadata** is **On**, (see [Data Logging/Options](#) for details), each data log file contains a Start Date and Start Time showing when the first reading was taken, the reading numbers, the sample interval, and the reading data. You can specify a comma, tab, or semicolon delimiter to separate the values.

	A	B	C	D	E
1	Start date:	11/6/2014	Start time	31:21.6	
2	Sample interval:	0.59			
3	Reading #	Reading			
4	1	2.12E-05			
5	2	-1.36E-03			
6	3	-2.04E-05			
7	4	-1.99E-05			
8	5	6.53E-06			
9	6	-1.35E-05			
10	7	-1.32E-04			
11	8	-2.32E-05			
12	9	-2.23E-05			
13	10	-2.34E-05			
14	11	-6.93E-06			
15	12	-3.31E-05			
16	13	-1.35E-05			
17	14	-1.07E-05			
18	15	-2.99E-05			
19	16	-1.09E-05			
20	17	3.33E-04			
21	18	-6.88E-05			
22	19	1.19E-05			
23	20	-2.68E-05			

When **Metadata** is off, only the reading data is saved:

Measurement Tutorial

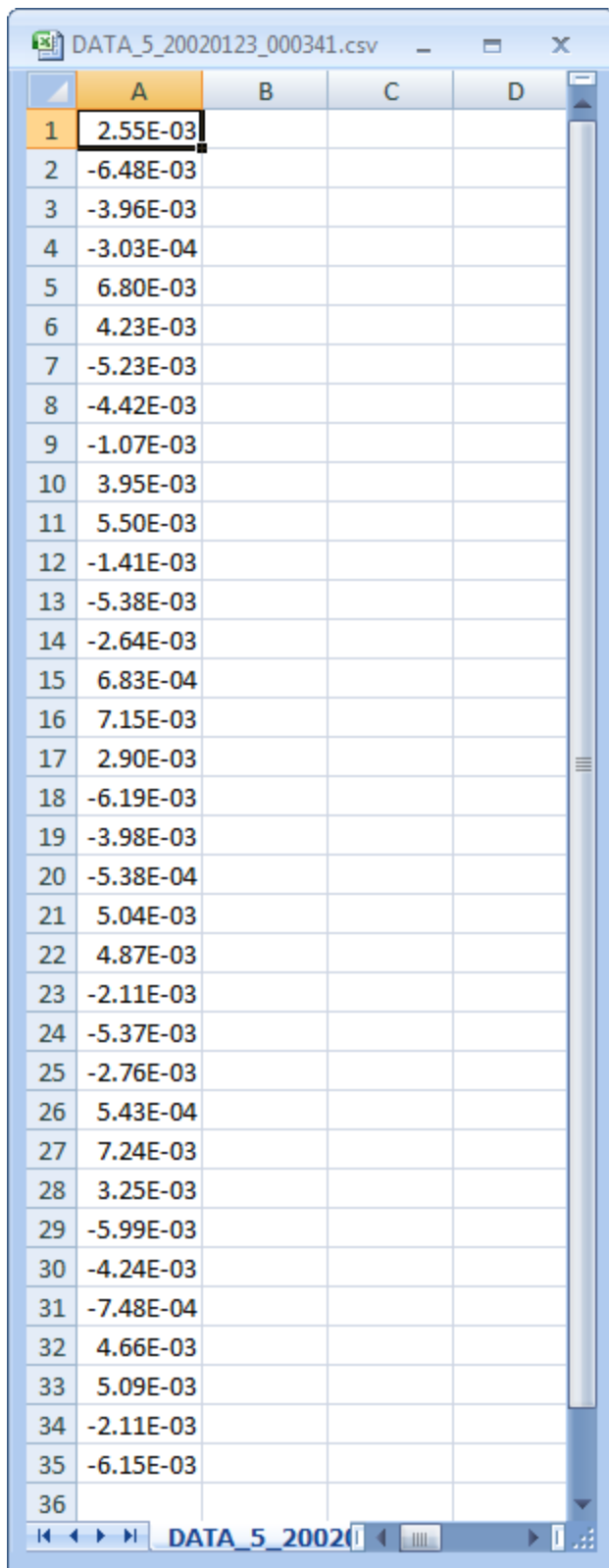

The image shows a spreadsheet window titled "DATA_5_20020123_000341.csv". The spreadsheet has four columns labeled A, B, C, and D. Column A contains 35 rows of data, with the first row highlighted. The values in column A are as follows:

Row	Value
1	2.55E-03
2	-6.48E-03
3	-3.96E-03
4	-3.03E-04
5	6.80E-03
6	4.23E-03
7	-5.23E-03
8	-4.42E-03
9	-1.07E-03
10	3.95E-03
11	5.50E-03
12	-1.41E-03
13	-5.38E-03
14	-2.64E-03
15	6.83E-04
16	7.15E-03
17	2.90E-03
18	-6.19E-03
19	-3.98E-03
20	-5.38E-04
21	5.04E-03
22	4.87E-03
23	-2.11E-03
24	-5.37E-03
25	-2.76E-03
26	5.43E-04
27	7.24E-03
28	3.25E-03
29	-5.99E-03
30	-4.24E-03
31	-7.48E-04
32	4.66E-03
33	5.09E-03
34	-2.11E-03
35	-6.15E-03
36	

Data Logging and the Trend Chart Display

- When data logging to memory, the trend chart maps each reading to a dot in a pixel column, draws a line between multiple dots in each column, and draws a line from the last reading in a column to the first reading in the next column.
- When data logging to a file, if the instrument determines the readings will fit in memory, the trend chart behaves as it does when data logging to memory. If there are too many readings to save in memory, the trend chart behaves in a manner similar to that of the continuous measurement mode. That is, the number of readings shown per pixel column depends on the reading rate and the selected Time Window.

Data Log and Digitizing Local Remote Interaction

CAUTION

Loss of data possible - local to remote transition clears instrument memory: When data logging or digitizing to *memory*, if you access the instrument from remote (send a SCPI or common command)* and then return to local (by pressing [**Local**]), the readings in memory are cleared and the instrument returns to Continuous mode.

For data logging only, you can prevent this situation by data logging to a file instead of to memory (see **Data Log Mode** for details). You can also prevent this from happening for data logging or digitizing by taking steps to keep the instrument from being accessed from remote. To prevent remote access, you may want to disconnect the LAN, GPIB, and USB interface cables from the instrument before starting the measurements. To prevent remote access via LAN, you can connect the instrument behind a router to minimize the possibility of remote access. You can also disable the various I/O interfaces from the front panel menu under [**Utility**] > **I/O Config**.

To view the status of a data logging or digitizing operation remotely, use the instrument's **Web User Interface**. The Web User Interface monitor does not set the instrument to remote.

**When accessed from remote, the instrument will continue data logging or digitizing to completion, and you can retrieve the readings from remote.*

Level Triggering

Level triggering is available only on the 34465A/70A with the DIG option. Level triggering allows you to trigger measurements at some defined point on the input signal, such as when the signal crosses zero volts or when it reaches the midpoint of its positive or negative peak amplitude. For example, this graphic shows sampling beginning as the input signal crosses 0V with a positive slope:

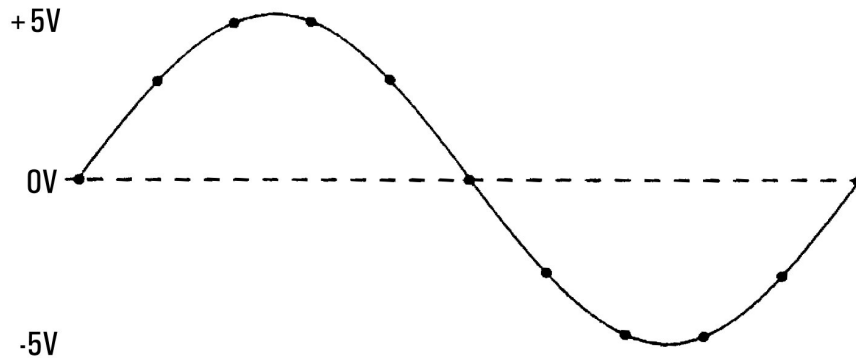

About Level Trigger

Level triggering is available for these measurement functions:

- DC voltage and DC current
- AC voltage and AC current
- 2-wire and 4-wire resistance with offset compensation off, and low power off
- Temperature, RTD or thermistor sensors only
- Frequency and period

The level trigger is edge-sensitive. That is, the instrument must detect a *change* in the quantity being measured from one side of the level setting to the other side (direction controlled by Slope setting). For example, if the Slope is positive, then the quantity being measured must first reach a value *below* the set level before a trigger event can be detected.

Level trigger performance is not uniform. Its accuracy, latency, and sensitivity are dependent on other DMM features. These dependencies vary by measurement function as described below.

DC voltage, DC current, and 2-wire resistance considerations

These measurement functions can use a fast-response detector built into the hardware for fixed-range measurements. For lowest latency and highest sensitivity, use a fixed range when using level trigger. However, trigger level accuracy is reduced when the hardware detector is used.

To increase trigger level accuracy and reduce sensitivity (avoid false triggers due to noise), use autorange:

Measurement Tutorial

- When auto-range is enabled, trigger level accuracy is increased, latency is increased, and sensitivity is decreased as the aperture or NPLC setting is increased.
- When auto-range is enabled, trigger level accuracy is increased, latency is increased, and sensitivity is decreased if autozero is enabled.
- When auto-range is enabled, range changes may be made while waiting for the trigger crossing which can cause additional latency/uncertainty.

4-wire resistance and temperature considerations

- Trigger level accuracy is increased, latency is increased, and sensitivity is decreased as aperture or NPLC is increased.
- Fixed range (only available for resistance) eliminates uncertainties (due to range change) in trigger latency.

AC voltage and AC current considerations

- Trigger latency is increased, and sensitivity is decreased as filter bandwidth is increased.
- Trigger latency can be controlled by trigger delay setting.
- Fixed range eliminates uncertainties (due to range change) in trigger latency.
- Autorange uncertainties become worse as filter bandwidth is increased.

Frequency and period considerations

- Trigger level accuracy is increased, latency is increased, and sensitivity is decreased as gate time is increased.
- Fixed voltage range eliminates uncertainties (due to range change) in trigger latency.

Other Sources of Measurement Error

Settling Time Effects

The multimeter can insert automatic measurement settling delays. These delays are adequate for resistance measurements with less than 200 pF of combined cable and device capacitance. This is particularly important when measuring resistances above 100 kΩ. Settling due to RC time constant effects can be quite long. Some precision resistors and multi-function calibrators use large parallel capacitors (1000 pF to 0.1 μF) with high resistor values to filter out noise currents injected by their internal circuitry. Non-ideal capacitances in cables and other devices may have much longer settling times than expected just by RC time constants due to dielectric absorption (soak) effects. Errors are measured when settling after the initial connection and after a range change.

Loading Errors (AC volts)

In the AC voltage function, the input of the multimeter appears as a 1 MΩ resistance in parallel with 100 pF of capacitance. The cabling that you use to connect signals to the multimeter also adds capacitance and loading. The table below shows the multimeter's approximate input resistance at various frequencies.

Input Frequency	Input Resistance (kΩ)
100 Hz	941
1 kHz	614
10 kHz	137
100 kHz	15.7

For low frequencies, the loading error is:

$$\text{Error (\%)} = \frac{-100 \times R_s}{R_s + 1 \text{ M}\Omega}$$

At high frequencies, the additional loading error is:

$$\text{Error (\%)} = 100 \times \left[\frac{1}{\sqrt{1 + (2 \pi \times F \times R_s \times C_{in})^2}} - 1 \right]$$

R_s = source resistance

F = input frequency

C_{in} = input capacitance (100 pF) plus cable capacitance

Measurements Below Full Scale

You can make the most accurate AC measurements when the multimeter is at or near the full scale of the selected range. Autoranging occurs at 10% (down-range) and 120% (up-range) of full scale. This enables you to measure some inputs at full scale on one range and 10% of full scale on the next higher range. In general, the accuracy is better on the lower range; for the highest accuracy, select the lowest manual range possible for the measurement.

High-Voltage Self-Heating Errors

If you apply more than 300 Vrms, self-heating occurs in the multimeter's internal signal-conditioning components. These errors are included in the multimeter's specifications. Temperature changes inside the multimeter due to self-heating may cause additional error on other AC voltage ranges. The additional error is less than 0.02% and dissipates in a few minutes.

AC Current Measurement Errors (Burden Voltage)

Burden voltage errors, which apply to DC current, also apply to AC current measurements. However, the burden voltage for AC current is larger due to the multimeter's series inductance and your measurement connections. The burden voltage increases as the input frequency increases. Some circuits may oscillate when performing current measurements due to the multimeter's series inductance and your measurement connections.

Low-Level Measurement Errors

AC voltage measurements less than 100 mV are especially susceptible to errors introduced by extraneous noise sources. An exposed test lead acts as an antenna and a properly functioning DMM will measure the signals received. The entire measurement path, including the power line, act as a loop antenna. Circulating currents in the loop create error voltages across any impedances in series with the DMM's input. Therefore, you should apply low-level AC voltages to the DMM through shielded cables, with the shield connected to the input LO terminal.

Connect the DMM and the AC source to the same electrical outlet whenever possible. You should also minimize the area of any ground loops that cannot be avoided. A high-impedance source is more susceptible to noise pickup than a low-impedance source. You can reduce the high-frequency impedance of a source by placing a capacitor in parallel with the DMM's input terminals. You may have to experiment to determine the correct capacitor for your application.

Most extraneous noise is not correlated with the input signal. You can determine the error as shown below.

$$\text{Voltage Measured} = \sqrt{V_{\text{in}}^2 + \text{Noise}^2}$$

Correlated noise, while rare, is especially detrimental because it always adds directly to the input signal. Measuring a low-level signal with the same frequency as the local power line is a common situation that is prone to this error.

Common Mode Errors

Errors are generated when the multimeter's input LO terminal is driven with an AC voltage relative to earth. The most common situation where unnecessary common mode voltages are created is when the output of an AC calibrator is connected to the multimeter "backwards." Ideally, a multimeter reads the same regardless of how the source is connected. Both source and multimeter effects can degrade this ideal situation. Because of the capacitance between the input LO terminal and earth (approximately 200 pF), the source will experience different loading depending on how the input is applied. The magnitude of the error is dependent upon the source's response to this loading.

The DMM's measurement circuitry, while extensively shielded, responds differently in the backward input case due to slight differences in stray capacitance to earth. The DMM's errors are greatest for high-voltage, high-frequency inputs. Typically, the DMM exhibits about 0.06% additional error for a 100 V, 100 kHz reverse input. You can use the grounding techniques described for DC common mode problems to minimize AC common mode voltages.

Leakage Current Errors

The DMM's input capacitance will "charge up" due to input bias currents when the terminals are open-circuited (if the input resistance is $>10\text{ G}\Omega$). The DMM's measuring circuitry exhibits approximately 30pA of input bias current for ambient temperatures from 0 to 30 °C. Bias current doubles for every 8 °C change in ambient temperature above 30 °C. This current generates small voltage offsets dependent upon the source resistance of the DUT. This effect becomes evident for a source resistance of greater than 100 k Ω , or when the DMM's operating temperature is significantly greater than 30 °C.

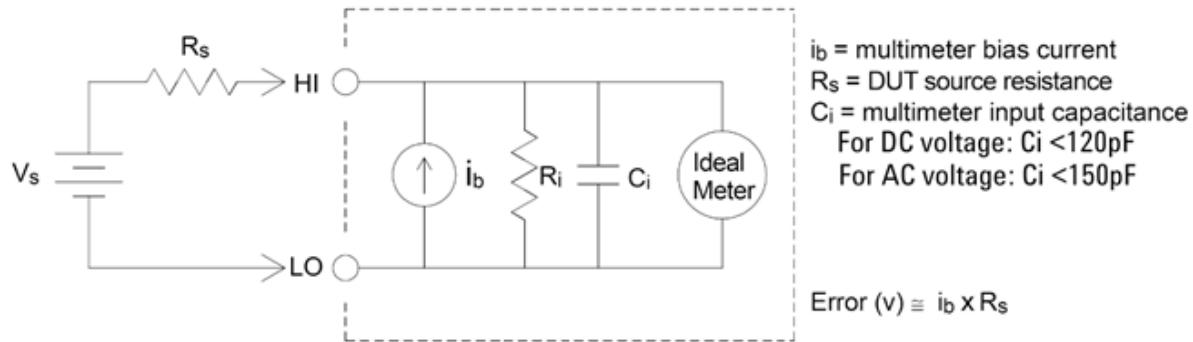

Unnecessary Signal Errors

Both 3A and 10A terminals are available for AC and DC current measurements. If signals are applied to terminals not being used for the current measurement, measurement errors may occur. The unused terminals are protected but the additional signals may interfere with current measurements. For example, applying inputs to the 3A terminals while making measurements on the 10A terminals will typically cause errors.

Unnecessary signals applied to the Hi and Lo Sense terminals can also cause errors. AC or DC voltages above 15 volts peak on the sense terminals are likely to cause measurement errors.

How Sample Rate/Interval is Determined

The DMM always attempts to make the sample interval greater than the expected time required to take the measurements, whether in continuous, data log, or digitize mode. A number of settings go into the calculation of the minimum allowable sample interval. These settings include the measurement function, NPLC, aperture, autorange, autozero, offset compensation, AC filter, TC open check and gate time. For example, when autorange is on, the assumption is that no more than one range change will be required. If more than one level of change occurs, the measurement may be delayed and an error will be issued.

When you change any of these settings, the sample interval (sample timer in continuous mode, sample interval in data log or digitize mode) is increased to be greater than the calculated measurement time. In the continuous and data log modes, attempting to reduce the sample interval below the calculated value results in an error message. You must then choose among the various ways you can achieve a smaller measurement time to achieve the smaller sample interval, such as decreasing the NPLC setting. For digitizing, the emphasis is on high sample rates and all settings except aperture/NPLC are fixed to achieve minimum measurement time. NPLC and aperture are automatically set to their minimum values upon entering digitize mode. If you set NPLC or aperture to greater values, the sample interval will be increased (or the sample rate decreased) to accommodate the longer measurement. However, in digitize mode, unlike continuous and data log modes, if you subsequently decrease the sample interval (or increase the sample rate), the NPLC or aperture will be reduced as needed.

Another way to put it is that for continuous and data log modes, sample timer/interval is always controlled by the other measurement settings. In digitize mode, the sample timer/interval, NPLC, and aperture have equal control; changing any one setting can change the other settings.

SCPI Programming Reference

This section contains information to help you program the Keysight Truevolt Series digital multimeters over a remote interface using the SCPI programming language.

[Introduction to the SCPI Language](#)

[Commands by Subsystem](#)

[Command Quick Reference](#)

[SCPI Error Messages](#)

[Power-On and Reset State](#)

Related Information

IO Libraries and Instrument Drivers

The Keysight IO Libraries Suite software and installation instructions are on the *Keysight Automation Ready CD-ROM* provided with your instrument (optional for 34460A).

Keysight Truevolt Series Documentation

The latest product documentation is available at www.keysight.com/find/truevolt-doc. For documentation for mobile devices, see www.keysight.com/find/truevolt-mobilehelp.

For information about connecting instruments to USB, LAN and GPIB interfaces and how to configure and troubleshoot these interfaces, refer to Keysight IO Libraries help. The Keysight IO Libraries can be downloaded from www.keysight.com/find/iosuite.

Web Interface

The 34461A/65A/70A and the 34460A (with option 34460A-LAN or option 3446LANU) have a Web Interface built into the instrument. You can use this interface over LAN for remote access and control of the instrument via a Web browser. See [Web Interface](#) for details.

Introduction to the SCPI Language

SCPI (Standard Commands for Programmable Instruments) is an ASCII-based programming language for test and measurement instruments. SCPI commands use a hierarchical structure known as a tree system. Associated commands are grouped under a common node or root, thus forming subsystems. A portion of the SENSE subsystem illustrates this, below.

```
SENSe:
  VOLTage:
    DC:RANGe {<range>|MIN|MAX|DEF}
    DC:RANGe? [MINimum|MAXimum|DEFault]
```

SENSe is the root keyword of the command, **VOLTage** is a second-level keyword, and **DC** is a third-level keyword. A colon (:) separates consecutive keywords.

Syntax Conventions

The command syntax format is illustrated below:

```
VOLTage:DC:RANGe {<range>|MIN|MAX|DEF}
```

Most commands (and some parameters) are a mixture of upper- and lower-case letters. The upper-case letters indicate the command's abbreviated spelling, which yields shorter program lines. For better program readability, use the long form.

For example, consider the keyword VOLTage, above. You can type VOLT or VOLTage in any combination of upper- or lower-case letters. Therefore, VolTaGe, volt and Volt are all acceptable. Other forms, such as VOL and VOLTAG, generate errors.

Braces ({ }) enclose the parameter choices. The braces are not sent with the command string.

A vertical bar (|) separates parameter choices. For example, {<range>|MIN|MAX|DEF} in the above command indicates that you can specify a numeric range parameter, or "MIN", "MAX" or "DEF". The bar is not sent with the command string.

Angle brackets (< >) indicate that you must specify a value for the enclosed parameter. For example, the above syntax statement shows the <range> parameter in angle brackets. Do not send the brackets with the command string. You must specify a value for the parameter (for example "VOLT:DC:RANG 10") unless you select one of the other options shown in the syntax (for example "VOLT:DC:RANG MIN").

Optional parameters are enclosed in square brackets ([]). The brackets are not sent with the command string. If you do not specify a value for an optional parameter, the instrument uses a default value.

Command Separators

A colon (:) separates consecutive keywords. You must insert a blank space to separate a parameter from a command keyword. If a command requires more than one parameter, separate adjacent parameters using a comma:

```
CONF:VOLT:DC 10,0.003
```

A semicolon (;) separates commands within the same subsystem and can also minimize typing. For example, the following string:

```
TRIG:SOUR EXT;COUNT 10
```

is equivalent to the following two commands:

```
TRIG:SOUR EXT  
TRIG:COUNT 10
```

Use a colon and a semicolon to link commands from different subsystems. For example, in the following example, an error is generated if you do not use both the colon and semicolon:

```
TRIG:COUN MIN;:SAMP:COUN MIN
```

Using the MIN, MAX and DEF Parameters

For many commands, you can substitute "MIN" or "MAX" in place of a parameter. In some cases you may also substitute "DEF". For example, consider The following example:

```
VOLTage:DC:RANGe {<range>|MIN|MAX|DEF}
```

Instead of selecting a specific value for the <range> parameter, you can substitute MIN to set the range to its minimum value, MAX to set the range to its maximum value or DEF to set the range to its default value.

Querying Parameter Settings

You can query the current value of most parameters by adding a question mark (?) to the command. For example, The following example sets the trigger count to 10 measurements:

```
TRIG:COUN 10
```

You can then query the count value by sending:

```
TRIG:COUN?
```

You can also query the minimum or maximum count allowed as follows:

```
TRIG:COUN? MIN  
TRIG:COUN? MAX
```

SCPI Command Terminators

A command string sent to the instrument must terminate with a <new line> (<NL>) character (ASCII decimal 10). The IEEE-488 EOI (End-Or-Identify) message is interpreted as a <NL> character and can be used to terminate a command string in place of a <NL> character. A <carriage return> followed by a <NL> is also accepted. Command string termination always resets the current SCPI command path to the root level.

NOTE

For every SCPI message that includes a query and is sent to the instrument, the instrument terminates the returned response with a <NL> or line-feed character (EOI). For example, if R? is sent, the response is terminated with a <NL> after the block of data that is returned. If a SCPI message includes multiple queries separated by semicolons (for example "ROUTE:TERMinals?;R?"), the returned response is again terminated by a <NL> after the response to the last query. In either case, the program must read this <NL> in the response before another command is sent to the instrument or an error occurs.

IEEE-488.2 Common Commands

The IEEE-488.2 standard defines a set of common commands that perform functions such as reset, self-test and status operations. Common commands always begin with an asterisk (*), are three characters in length and may include one or more parameters. The command keyword is separated from the first parameter by a blank space. Use a semicolon (;) to separate multiple commands as shown below:

```
*RST; *CLS; *ESE 32; *OPC?
```

SCPI Parameter Types

The SCPI language defines several data formats to be used in program messages and response messages.

Numeric Parameters

Commands that require numeric parameters accept all commonly used decimal representations of numbers including optional signs, decimal points, and scientific notation. Special values for numeric parameters such as MIN, MAX and DEF are also accepted. You can also send engineering unit suffixes with numeric parameters (e.g., M, k, m or u). If a command accepts only certain specific values, the instrument rounds the input numeric parameters to the accepted values. The following command requires a numeric parameter for the range value:

```
VOLTage:DC:RANGe {<range>|MIN|MAX|DEF}
```

NOTE

Because the SCPI parser is case-insensitive, there is some confusion over the letter "M" (or "m"). For your convenience, the instrument interprets "mV" (or "MV") as millivolts, but "MHZ" (or "mhz") as megahertz. Likewise "MΩ" (or "mΩ") is interpreted as megΩ. You can use the prefix "MA" for mega. For example, "MAV" is interpreted as megavolts.

Discrete Parameters

Discrete parameters are used to program settings that have a limited number of values (like IMMEDIATE, EXTERNAL or BUS). They have a short form and a long form just like command keywords. You can mix upper- and lower-case letters. Query responses always return the short form in all upper-case letters. The following example requires a discrete parameters for the temperature units:

```
UNIT:TEMPERature {C|F|K}
```

Boolean Parameters

Boolean parameters represent a single binary condition that is either true or false. For a false condition, the instrument accepts "OFF" or "0". For a true condition, the instrument accepts "ON" or "1". When you query a Boolean setting, the instrument returns "0" or "1". The following example requires a Boolean parameter:

```
DISPlay:STATe {ON|1|OFF|0}
```

ASCII String Parameters

String parameters can contain virtually any set of ASCII characters. A string must begin and end with matching quotes; either with a single quote or a double quote. You can include the quote delimiter as part of the string by typing it twice without any characters in between. The following command uses a string parameter:

```
DISPlay:TEXT <quoted string>
```

For example, The following example displays the message "WAITING..." on the instrument's front panel (the quotes are not displayed).

```
DISP:TEXT "WAITING..."
```

You can also display the same message using The following example with single quotes.

```
DISP:TEXT 'WAITING...'
```

Using Device Clear

Device Clear is an IEEE-488 low-level bus message that you can use to return the instrument to a responsive state. Different programming languages and IEEE-488 interface cards provide access to this capability through their own unique commands. The status registers, the error queue, and all configuration states are left unchanged when a Device Clear message is received.

Device Clear performs the following actions:

- If a measurement is in progress, it is aborted.
- The instrument returns to the trigger "idle" state.
- The instrument's input and output buffers are cleared.
- The instrument is prepared to accept a new command string.
- An overlapped command, if any, is terminated with no "Operation Complete" indication (applies to INIT).

NOTE The `ABORt` command is the recommended method to terminate a measurement.

Commands by Subsystem

`ABORt`

`CALCulate:CLEAr[:IMMEDIATE]`

`CALCulate:AVERage` Subsystem

`CALCulate:LIMit` Subsystem

`CALCulate:SCALE` Subsystem

`CALCulate:SMOothing` Subsystem

`CALCulate:TCHart[:STATE]`

`CALCulate:TRANSform:HISTogram` Subsystem

`CALibration` Subsystem

`CONFigure` Subsystem

`DATA` Subsystem

`DISPlay` Subsystem

`FETCH?`

`FORMat` Subsystem

`HCOPY` Subsystem

IEEE 488.2 Common Commands

`INITiate[:IMMEDIATE]`

`LXI` Subsystem

SCPI Programming Reference

MEASure Subsystem

MMEMory Subsystem - Data Transfer Commands

MMEMory Subsystem - General Purpose File Management

MMEMory Subsystem - STATE and PREFerence Files

OUTPut:TRIGger:SLOPe

R?

READ?

ROUte:TERMinals?

SAMPle Subsystem

[SENSe:]CAPacitance Subsystem

[SENSe:]CURRent Subsystem

[SENSe:]DATA2 Subsystem

[SENSe:]{FREQuency|PERiod} Subsystem

[SENSe:]{RESistance|FRESistance} Subsystem

[SENSe:]TEMPerature Subsystem

[SENSe:]VOLTage Subsystem

STATus Subsystem

SYSTem Subsystem - General Purpose Commands

SYSTem Subsystem - I/O Configuration

SYSTem:LICense Subsystem

SYSTem:LOCK Subsystem

TEST:ALL?

TRIGger Subsystem

UNIT:TEMPerature

ABORt

Aborts a measurement in progress, returning the instrument to the trigger idle state.

Parameter	Typical Return
(none)	(none)
Abort a measurement in progress: ABORt	

- Use this to abort a measurement when the instrument is waiting for a trigger, or for aborting a long measurement or series of measurements.

FETCh?

Waits for measurements to complete and copies all available measurements to the instrument's output buffer. The readings remain in reading memory.

Parameter	Typical Return
(none)	(none)
<p>Use FETCh? with CONFIgure and INITiate. The INITiate command places the instrument in the "wait-for-trigger" state, triggers a measurement when the rear-panel Ext Trig input is pulsed (low by default), and sends the measurement to reading memory. The FETCh? query transfers the measurement from reading memory to the instrument's output buffer.</p> <p>CONF:VOLT:DC 10,0.003 TRIG:SOUR EXT SAMP:COUN 4 INIT FETC?</p> <p>Typical Response: -4.98748741E-01,-4.35163427E-01,-4.33118686E-01,-3.48109378E-01</p>	

- The FETCh? query does not erase measurements from the reading memory. You can send the query multiple times to retrieve the same data.
- You can store up to 1,000 measurements in the reading memory of the 34460A, 10,000 measurements on the 34461A, 50,000 measurements on the 34465A/70A (*without* the MEM option), or 2,000,000 measurements on the 34465A/70A (*with* the MEM option). If reading memory overflows, new measurements overwrite the oldest measurements stored; the most recent measurements are always preserved. No error is generated, but the Reading Mem Ovfl bit (bit 14) is set in the Questionable Data Register's condition register (see [Status System Introduction](#)).
- The instrument clears all measurements from reading memory when the measurement configuration changes, or when any of these commands are executed: **INITiate**, **MEASure:<function>?**, **READ?**, ***RST**, **SYSTem:PRESet**.

INITiate[:IMMEDIATE]

Changes the state of the triggering system from "idle" to "wait-for-trigger", and clears the previous set of measurements from reading memory. Measurements begin when the specified trigger conditions are satisfied following the receipt of **INITiate**.

Parameter	Typical Return
(none)	(none)
Return five DC voltage measurements, using a software trigger to start the measurements: CONF:VOLT:DC 10,0.003 TRIG:SOUR BUS SAMP:COUN 5 INIT *TRG FETC?	

- Storing measurements in reading memory with **INITiate** is faster than sending measurements to the instrument's output buffer using **READ?** (provided you do not send **FETCh?** until done). The **INITiate** command is also an "overlapped" command. This means that after executing **INITiate**, you can send other commands that do not affect the measurements.
- You can store up to 1,000 measurements in the reading memory of the 34460A, 10,000 measurements on the 34461A, 50,000 measurements on the 34465A/70A (*without* the MEM option), or 2,000,000 measurements on the 34465A/70A (*with* the MEM option). If reading memory overflows, new measurements overwrite the oldest measurements stored; the most recent measurements are always preserved. No error is generated, but the Reading Mem Ovfl bit (bit 14) is set in the Questionable Data Register's condition register (see **Status System Introduction**).
- To retrieve the measurements from the reading memory, use **FETCh?**. Use **DATA:REMOve?** or **R?** to read and erase all or part of the available measurements.
- Use **ABORt** to return to idle.

OUTPut:TRIGger:SLOPe {POSitive|NEGative}
 OUTPut:TRIGger:SLOPe?

Selects the slope of the *voltmeter complete* output signal on the rear-panel **VM Comp** BNC connector.

Parameter	Typical Return
{POSitive NEGative}. Default: NEG	POS or NEG
Configure DC voltage measurements and make two measurements. The signal on the rear-panel VM Comp connector outputs a positive pulse as each measurement is completed: CONF:VOLT:DC 10 SAMP:COUN 2 OUTP:TRIG:SLOP POS INIT	

- On the 34460A, this requires option 34460A-LAN or option 3446LANU.
- This parameter is set to its default value after a Factory Reset (***RST**) or Instrument Preset (**SYSTem:PRESet**).

R? [<max_readings>]

Reads and erases all measurements from reading memory up to the specified <max_readings>. The measurements are read and erased from the reading memory starting with the oldest measurement first.

Parameter	Typical Return
1 to 2,000,000 (readings) Default is all readings in memory.	(none)
Read and remove the three oldest readings: R? 3 Typical Response: #247-4.98748741E-01,-4.35163427E-01,-7.41859188E-01 The "#2" means that the next 2 digits indicate how many characters are in the returned memory string. These two digits are the "47" after the "#2". Therefore, the remainder of the string is 47 digits long: -4.98748741E-01,-4.35163427E-01,-7.41859188E-01	

- The **R?** and **DATA:REMove?** queries can be used during a long series of readings to periodically remove readings from memory that would normally cause the reading memory to overflow. **R?** does not wait for all readings to complete. It sends the readings that are complete at the time the instrument receives the command. Use **Read?** or **Fetch?** if you want the instrument to wait until all readings are complete before sending readings.
- If you do not specify a value for <max_readings>, all measurements are read and erased.
- No error is generated if the reading memory contains less readings than requested. In this case, all available readings in memory are read and deleted.
- The number of readings returned may be less than that requested depending on the amount of reading memory in your instrument. You can store up to 1,000 measurements in the reading memory of the 34460A, 10,000 measurements on the 34461A, 50,000 measurements on the 34465A/70A (*without* the MEM option), or 2,000,000 measurements on the 34465A/70A (*with* the MEM option). If reading memory overflows, new measurements overwrite the oldest measurements stored; the most recent measurements are always preserved. No error is generated, but the Reading Mem Ovfl bit (bit 14) is set in the Questionable Data Register's condition register (see **Status System Introduction**).
- The instrument clears all measurements from reading memory when the measurement configuration changes, or when any of these commands are executed: **INITiate**, **MEASure:<function>?**, **READ?**, ***RST**, **SYSTem:PRESet**.

READ?

Starts a new set of measurements, waits for all measurements to complete, and transfers all available measurements. Sending READ? is similar to sending **INITiate** followed immediately by **FETCh?**.

Parameter	Typical Return
(none)	(none)
Transfer measurements from reading memory: READ? Typical Response: -4.98748741E-01,-4.35163427E-01,-4.33118686E-01,-3.48109378E-01	

- The **FETCh?** query does not erase measurements from the reading memory. You can send the query multiple times to retrieve the same data.
- You can store up to 1,000 measurements in the reading memory of the 34460A, 10,000 measurements on the 34461A, 50,000 measurements on the 34465A/70A (*without* the MEM option), or 2,000,000 measurements on the 34465A/70A (*with* the MEM option). If reading memory overflows, new measurements overwrite the oldest measurements stored; the most recent measurements are always preserved. No error is generated, but the Reading Mem Ovfl bit (bit 14) is set in the Questionable Data Register's condition register (see **Status System Introduction**).
- The instrument clears all measurements from reading memory when the measurement configuration changes, or when any of these commands are executed: **INITiate**, **MEASure:<function>?**, **READ?**, ***RST**, **SYSTem:PRESet**.

ROUTe:TERMinals?

Indicates which input terminals are selected on the 34461A front panel **Front/Rear** switch. This switch is not programmable; this query reports the position of the switch, but cannot change it.

WARNING Do not toggle the Front/Rear switch with active signals on the terminals. This switch is not intended to be used in this way and may be damaged by high voltages or currents, possibly compromising the instrument's safety features.

Parameter	Typical Return
(none)	FRON or REAR
Return the state of the Front/Rear switch: ROUT:TERM?	

- On the 34460A, this query always returns FRON.

TEST:ALL?

Runs an instrument self-test and returns a pass/fail indication. The **TEST:ALL?** self-test is more comprehensive than the ***TST?** self-test.

CAUTION You must remove all input connections to the instrument before running the full self-test.

Parameter	Typical Return
(none)	(none)
Run a self-test: TEST:ALL? Typical Response: +0 (pass) or +1 (one or more tests failed)	

- If one or more tests fail, the query returns +1 and stores an error in the error queue. For a complete listing of the error messages related to self-test failures, see [Self-test Error Messages](#).
- Following the test, the instrument returns to the instrument state that existed before the self-test.

UNIT:TEMPerature {C|F|K}

UNIT:TEMPerature?

Selects the units (°C, °F or Kelvin) to be used for all temperature measurements except the **SYSTem:TEMPerature?** query.

Parameter	Typical Return
{C F K}. Default: C.	C, F, or K
Make a four-wire RTD measurement and return the result in °F: UNIT:TEMP F MEAS:TEMP? FRTD Typical Response: +6.82320000E+01	

- The command also accepts CEL or FAR, but the query returns C or F.
- This parameter is set to its default value after a Factory Reset (***RST**) or Instrument Preset (**SYSTem:PRESet**).

See Also

CONFigure:TEMPerature

MEASure:TEMPerature?

[SENSe:]FUNction[:ON]

CALCulate Subsystem Introduction

The CALCulate subsystem receives real-time data from the measurement hardware and sends them to reading memory. It also optionally performs the following math operations, as shown in the diagram below:

- Smoothing
- Scaling
- Statistics
- Limit checking
- Histogram

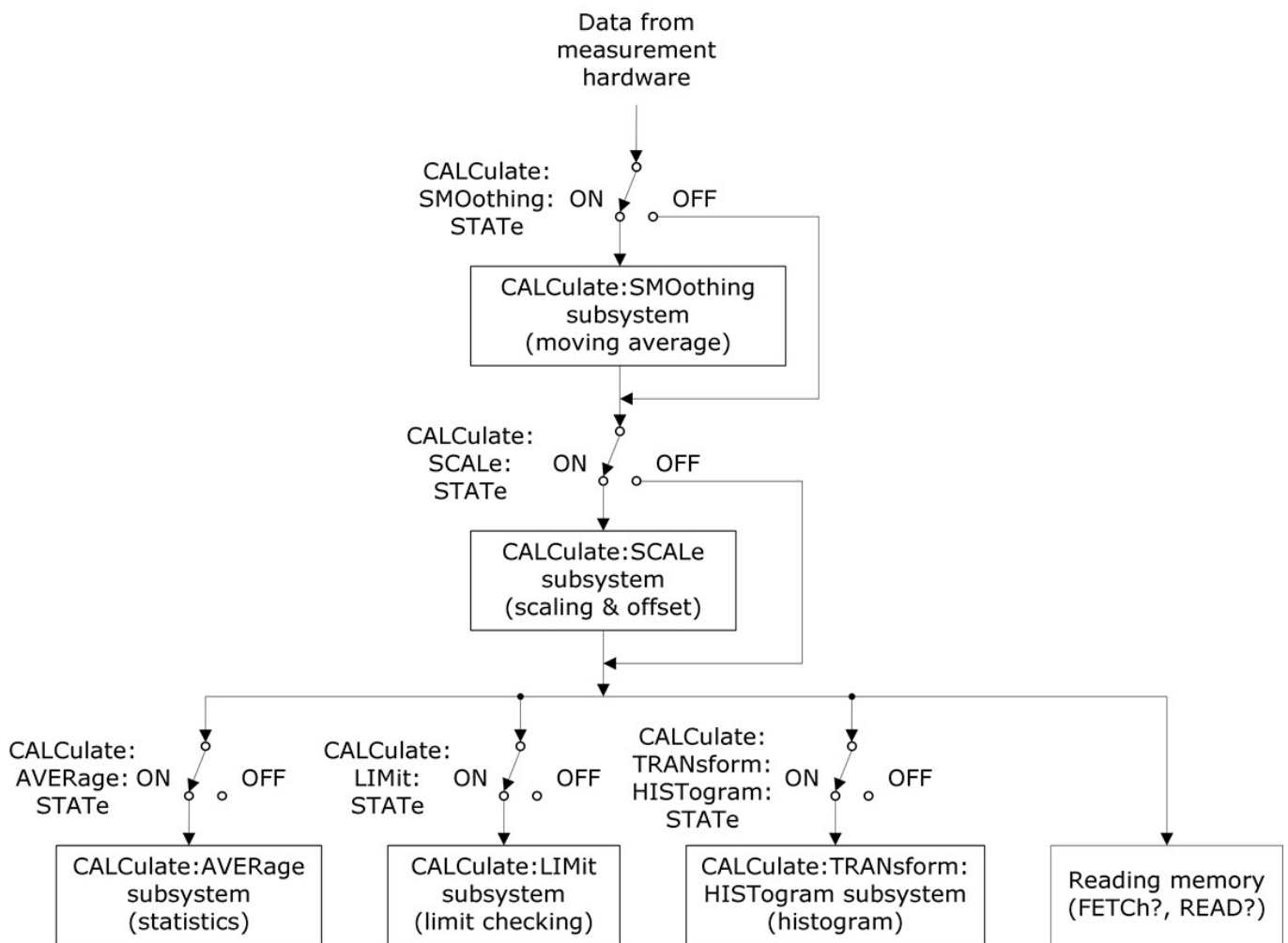

Only calculations enabled by **CALC:SCAL:STAT**, **CALC:TRAN:HIST:STAT**, **CALC:LIM:STAT**, and **CALC:AVER:STAT** are performed.

Parts of the CALCulate Subsystem

CALCulate:CLEAr[:IMMEdiate]

AVERAge Subsystem

HISTogram Subsystem

LIMit Subsystem

SCALing Subsystem

SMOothing Subsystem

CALCulate:CLEar[:IMMediate]

Clears all limits, histogram data, statistics, and measurements.

Parameter	Typical Return
(none)	(none)
Clear all limits, histogram data, statistics, and measurements: CALC:CLE:IMM	

- Items are cleared synchronously; histogram, statistics, and limit data all restart at the same time that measurements restart.

CALCulate:LIMit Subsystem

This subsystem specifies measurements and indicates when a limit has been exceeded.

Example

The following example enables limit testing of 100 DC voltage measurements and indicates whether measurements were outside the range of 3.2 to 3.4 V. Measurements above 3.4 V set bit 12 (Upper Limit Failed) of the Questionable Status Register; measurements below 3.2 V set bit 11 (Lower Limit Failed).

```
*CLS
STAT:PRES
CONF:VOLT 10,.001
SAMP:COUN 100
CALC:LIM:LOW 3.2
CALC:LIM:UPP 3.4
CALC:LIM:STAT ON
INIT
*WAI
STAT:QUES?
```

Typical Response: +4096 (at least one measurement was above the upper limit)

Command Summary

CALCulate:LIMit:CLEar[:IMMEDIATE]

CALCulate:LIMit:{LOWer|UPPer}[:DATA]

CALCulate:LIMit[:STATe]

CALCulate:LIMit:CLEar[:IMMEDIATE]

Clears front panel indications of limits being exceeded and clears bit 11 ("Lower Limit Failed") and bit 12 ("Upper Limit Failed") in the Condition Register of the Questionable Data Register event register group. The corresponding event register bits are unaffected.

A condition register continuously monitors the state of the instrument. Condition register bits are updated in real time; they are neither latched nor buffered.

An event register is a read-only register that latches events from the condition register. While an event bit is set, subsequent events corresponding to that bit are ignored.

Parameter	Typical Return
(none)	(none)
Clear the limit test results:	
CALC:LIM:CLE	

- Does not clear measurements in reading memory.
- The instrument clears front panel indications of limits being exceeded and clears bits 11 and 12 in the Questionable Data Register when the measurement function changes, or when any of the following commands is executed:

CALCulate:LIMit:STATe ON

INITiate

MEASure:<function>?

READ?

CALCulate:LIMit:CLEar

*RST

SYSTem:PRESet

- To clear statistics, limits, histogram data, and measurement data, use **CALCulate:CLEar[:IMMEDIATE]**.

CALCulate:LIMit:{LOWer|UPPer}[:DATA] {<value>|MIN|MAX|DEF}
CALCulate:LIMit:{LOWer|UPPer}[:DATA]? [{MIN|MAX|DEF}]

Sets an upper or lower limit.

Parameter	Typical Return
-1.0E+15 to -1.0E-15, or 0.0 (default) or +1.0E-15 to 1.0E+15	+1.00000000E+00
See Example .	

- You can assign a lower limit, an upper limit or both. Do not set the lower limit above the upper limit.
- *Limit crossing*: If a measurement is less than the specified lower limit, bit 11 ("Lower Limit Failed") is set in the Questionable Data Condition Register. A measurement greater than the specified upper limit sets bit 12 ("Upper Limit Failed"). See [STATus Subsystem Introduction](#) for further information.
- **CONFigure** resets both limits to 0.
- This parameter is set to its default value after a Factory Reset (***RST**) or Instrument Preset (**SYSTem:PRESet**).

CALCulate:LIMit[:STATe] {ON|1|OFF|0}
CALCulate:LIMit[:STATe]?

Enables or disables limit testing.

Parameter	Typical Return
{ON 1 OFF 0}. Default: OFF.	0 (OFF) or 1 (ON)
See Example .	

- The instrument clears front panel indications of limits being exceeded and clears bits 11 and 12 in the Questionable Data Register when the measurement function changes, or when any of the following commands is executed:

CALCulate:LIMit:STATe ON

INITiate

MEASure:<function>?

READ?

CALCulate:LIMit:CLEar

***RST**

SYSTem:PRESet

- The instrument turns this setting OFF when the measurement function is changed or after ***RST** or **SYSTem:PRESet**.

CALCulate:TRANSform:HISTogram Subsystem

The HISTogram subsystem configures the histogram display. The instrument clears histogram data when the measurement function changes and when any of the following commands are sent:

CALCulate:TRANSform:HISTogram:CLEar[:IMMediate]

CALCulate:TRANSform:HISTogram:POINts

CALCulate:TRANSform:HISTogram:RANGe:AUTO

CALCulate:TRANSform:HISTogram:RANGe:{LOWer|UPPer}

CALCulate:TRANSform:HISTogram[:STATe]

INITiate[:IMMediate]

MEASure:<function>?

READ?

*RST

SYSTem:PRESet

Command Summary

CALCulate:TRANSform:HISTogram:ALL?

CALCulate:TRANSform:HISTogram:CLEar[:IMMediate]

CALCulate:TRANSform:HISTogram:COUNt?

CALCulate:TRANSform:HISTogram:DATA?

CALCulate:TRANSform:HISTogram:POINts

CALCulate:TRANSform:HISTogram:RANGe:AUTO

CALCulate:TRANSform:HISTogram:RANGe:{LOWer|UPPer}

CALCulate:TRANSform:HISTogram[:STATe]

Example

This example enables an automatically scaled, 100-bin histogram of 1000 DCV measurements. It then returns the computed histogram, including the lower and upper range values, the total measurement count, and the bin data.

```
CONF:VOLT:DC 10,0.001
SAMP:COUN 1000
CALC:TRAN:HIST:RANG:AUTO ON
CALC:TRAN:HIST:POIN 100
CALC:TRAN:HIST:STAT ON
INIT
*WAI
CALC:TRAN:HIST:ALL?
```

Typical Response: +9.99383828E+00,+1.00513398E+01,+1000,<102 bin counts>

NOTE The above response indicates 102 bin counts because the histogram includes bins for values below and above the histogram range.

CALCulate:TRANSform:HISTogram:ALL?
CALCulate:TRANSform:HISTogram:DATA?

The ALL form of the query returns a comma-separated list of the lower and upper range values, the number of measurements, and the bin data collected since the last time the histogram data was cleared. The DATA form returns only the bin data.

Parameter	Typical Return
(none)	See Example .
See Example .	

- The bin data includes the following, in order:
 - The number of measurements less than the lower range value
 - The number of measurements in the each of the bins, starting at the lower range value bin
 - The number of measurements greater than the upper range value
- Range values are real numbers returned in the form +1.00000000E+00. The number of measurements and bin data are signed, positive integers returned in the form +100.

CALCulate:TRANSform:HISTogram:CLEar[:IMMediate]

Clears the histogram data and restarts histogram ranging if it is enabled (**CALCu-
late:TRANSform:HISTogram:RANGe:AUTO ON**).

Parameter	Typical Return
(none)	(none)
Clear the histogram data:	
CALC:TRAN:HIST:CLE	

- Does not clear measurements in reading memory.
- To clear statistics, limits, histogram data, and measurement data, use **CALCulate:CLEar[:IMMediate]**.

CALCulate:TRANSform:HISTogram:COUNT?

Returns the number of measurements collected since the last time the histogram was cleared.

Parameter	Typical Return
(none)	+87
Return the number of measurements used to compute the current histogram:	
CALC:TRAN:HIST:COUN?	

CALCulate:TRANSform:HISTogram:POINts {<value>|MIN|MAX|DEF}

CALCulate:TRANSform:HISTogram:POINts? [{MIN|MAX|DEF}]

Sets the number of bins between the lower and upper range values for the histogram. Two additional bins always exist: one for measurements below the lower range and one for measurements above the upper range.

Parameter	Typical Return
{10 20 40 100 200 400 MIN MAX DEF}. Default: 100.	+100
See Example .	

- You can specify the lower and upper range values using **CALCulate:TRANSform:HISTogram:RANGe: {LOWer|UPPer}**. Lower and upper range values are computed automatically if **CALCu-
late:TRANSform:HISTogram:RANGe:AUTO** is ON.
- This parameter is set to its default value after a Factory Reset (***RST**) or Instrument Preset (**SYSTem:PRESet**).

CALCulate:TRANSform:HISTogram:RANGe:AUTO {ON|1|OFF|0}
CALCulate:TRANSform:HISTogram:RANGe:AUTO?

Enables or disables automatic selection of the histogram's lower and upper range values.

Parameter	Typical Return
{ON 1 OFF 0}. Default: ON.	0 (OFF) or 1 (ON)
See Example .	

- **ON**: the instrument uses the first 1,000 measurements to set the lower and upper range values.
- **OFF**: the lower and upper range values are specified by **CALCulate:TRANSform:HISTogram:RANGe:{LOWer|UPPer}**.
- Setting the lower or upper range value (**CALCulate:TRANSform:HISTogram:RANGe:{LOWer|UPPer}**) disables automatic selection of the lower and upper range values (**CALCulate:TRANSform:HISTogram:RANGe:AUTO OFF**).
- The instrument restarts automatic range value selection (if enabled) when **INITiate**, **MEASure?** or **READ?** is executed.
- This parameter is set to its default value after a Factory Reset (***RST**) or Instrument Preset (**SYSTem:PRESet**).

CALCulate:TRANSform:HISTogram:RANGe:{LOWer|UPPer} {<value>|MIN|MAX|DEF}
CALCulate:TRANSform:HISTogram:RANGe:{LOWer|UPPer}? [{MIN|MAX|DEF}]

Sets the histogram's lower and upper range values. Setting the lower or upper range value (**CALCulate:TRANSform:HISTogram:RANGe:{LOWer|UPPer}**) disables automatic selection of the lower and upper range values (**CALCulate:TRANSform:HISTogram:RANGe:AUTO OFF**).

Parameter	Typical Return
-1.0E+15 to -1.0E-15, or 0.0 (default) or +1.0E-15 to 1.0E+15	+1.000000000E+06
See Example .	

- If automatic range value selection is enabled (**CALCulate:TRANSform:HISTogram:RANGe:AUTO ON**), the query returns the computed range value. If no histogram data exists, 9.91E37 (Not a Number) is returned.
- Lower and upper range values are computed automatically if **CALCulate:TRANSform:HISTogram:RANGe:AUTO** is ON.
- This parameter is set to its default value after a Factory Reset (***RST**) or Instrument Preset (**SYSTem:PRESet**).

CALCulate:TRANSform:HISTogram[:STATe] {ON|1|OFF|0}
CALCulate:TRANSform:HISTogram[:STATe]?

Enables or disables histogram computation.

Parameter	Typical Return
{ON 1 OFF 0}. Default: OFF.	0 (OFF) or 1 (ON)
See Example .	

- The instrument turns this setting OFF when the measurement function is changed or after ***RST** or **SYSTem:PRESet**.

CALCulate:SCALE Subsystem

This subsystem controls math scaling.

Command Summary

CALCulate:SCALE:DB:REFerence

CALCulate:SCALE:DBM:REFerence

CALCulate:SCALE:FUNction

CALCulate:SCALE:GAIN

CALCulate:SCALE:OFFSet

CALCulate:SCALE:REFerence

CALCulate:SCALE:REFerence:AUTO

CALCulate:SCALE[:STATe]

CALCulate:SCALE:UNIT

CALCulate:SCALE:UNIT:STATe

CALCulate:SCALE:DB:REFerence {<reference>|MIN|MAX|DEF}
CALCulate:SCALE:DB:REFerence? [{MIN|MAX|DEF}]

Stores a relative value in the multimeter's dB Relative Register, which is used for the dB function in **CALCulate:SCALE:FUNction**. When the dB function is enabled, this value is subtracted from each voltage measurement after the measurement is converted to dBm.

Parameter	Typical Return
-200.0 dBm to +200.0 dBm. Default: 0.	+3.00000000E+02
Enable dB scaling with a -10 dB reference and a 300 Ω dBm reference resistance:	
CALC:SCAL:DBM:REF 300	
CALC:SCAL:DB:REF -10.0	
CALC:SCAL:FUNC DB	
CALC:SCAL:STAT ON	

- Specifying a reference value disables automatic reference selection (**CALCulate:SCALE:REFerence:AUTO OFF**).
- The dB relative value parameter is relative to the dBm reference resistance set with **CALCulate:SCALE:DBM:REFerence**.
- The instrument sets the reference value to 0.0 with automatic reference selection enabled after a Factory Reset (***RST**), an Instrument Preset (**SYSTem:PRESet**), or a change in measurement function.

CALCulate:SCALE:DBM:REFerence {<reference>|MIN|MAX|DEF}
CALCulate:SCALE:DBM:REFerence? [{MIN|MAX|DEF}]

Selects the reference resistance for converting voltage measurements to dBm. This reference value affects the dBm and dB scaling functions.

Parameter	Typical Return
50, 75, 93, 110, 124, 125, 135, 150, 250, 300, 500, 600, 800, 900, 1000, 1200 or 8000 Ω. Default: 600.	+3.00000000E+02
Enable dBm scaling with a reference resistance of 300 Ω: CALC:SCAL:DBM:REF 300 CALC:SCAL:FUNC DBM CALC:SCAL:STAT ON	

- The instrument sets the reference value to its default value after a Factory Reset (***RST**), an Instrument Preset (**SYSTem:PRESet**), or a change in measurement function.

CALCulate:SCALE:FUNcTION {DB|DBM|PCT|SCALE}
CALCulate:SCALE:FUNcTION?

Selects the operation performed by the scaling function.

Parameter	Typical Return
{DB DBM PCT SCALE}	DB, DBM, PCT, or SCALE
Enable the DB scaling function referenced to the next measurement taken: CALC:SCAL:FUNC DB CALC:SCAL:STAT ON	

- The PCT and SCALE functions apply only to the 34465A and 34470A.
- DB performs a relative dB computation. The result is the difference between the input signal and the stored DB relative value reference (**CALCulate:SCALE:DB:REFerence**), with both values converted to dBm (dB = measurement in dBm – relative value in dBm). For the dB function, the reference value can be automatically selected using the first measurement converted to dBm as the reference value (see **CALCulate:SCALE:REFerence:AUTO**), or it can be specified by **CALCulate:SCALE:DB:REFerence**. dB scaling applies to ACV and DCV measurements only.
- DBM performs a dBm computation. The result is logarithmic and is based on a calculation of power delivered to a reference resistance (**CALCulate:SCALE:DBM:REFerence**), relative to 1 milliwatt. (dBm = 10 × log₁₀(measurement² / reference resistance / 1 mW)). dBm scaling applies to ACV and DCV measurements only.

- PCT performs a percent change operation. The result is the percent change of the measurement from the reference value:

$$\text{Result} = ((\text{Measurement} - \text{Reference}) / \text{Reference}) * 100$$

For the PCT function, the reference value can be automatically selected using the first measurement as the reference value (see `CALCulate:SCALE:REFerence:AUTO`), or it can be specified by `CALCulate:SCALE:REFerence`. % scaling applies to all measurement functions except Ratio, Continuity, and Diode.

- SCALE performs an Mx-B operation. The result is the measurement multiplied by the gain value M (`CALCulate:SCALE:GAIN`) minus the offset value B (`CALCulate:SCALE:OFFSet`). Mx-B scaling applies to all measurement functions except Ratio, Continuity, and Diode.
- Scaling function results must be in the range of -1.0E+24 to -1.0E-24, or +1.0E-24 to 1.0E+24. Results outside these limits will be replaced with -9.9E37 (negative infinity), 0, or 9.9E37 (positive infinity).
- You must execute `CALCulate:SCALE:FUNction` before executing `CALCulate:SCALE[:STATe]`, otherwise an incompatibility error will be generated.
- This parameter is set to its default value after a Factory Reset (`*RST`) or Instrument Preset (`SYSTem:PRESet`).
- Scaling is set to OFF when you change measurement functions (for example, changing from DCV to ACV). You must re-enable scaling after changing measurement functions.

`CALCulate:SCALE:GAIN {<gain>|MIN|MAX|DEF}`
`CALCulate:SCALE:GAIN? [{MIN|MAX|DEF}]`

Stores a gain value *M* for the scaling function in `CALCulate:SCALE:FUNction`.

Parameter	Typical Return
-1.0E+15 to -1.0E-15, 0.0, +1.0E-15 to 1.0E+15. Default: 1.0.	+1.00000000E+02
Enable Mx-B scaling with a gain of 100 and an offset of 5. <code>CALC:SCAL:FUNC SCAL</code> <code>CALC:SCAL:GAIN 100</code> <code>CALC:SCAL:OFFS 5</code> <code>CALC:SCAL:STAT ON</code>	

- Applies only to the 34465A and 34470A.
- The instrument sets the gain value to 0.0 after a Factory Reset (`*RST`) or Instrument Preset (`SYSTem:PRESet`).

CALCulate:SCALE:OFFSet {<offset>|MIN|MAX|DEF}
CALCulate:SCALE:OFFSet? [{MIN|MAX|DEF}]

Stores an offset value *B* for the scaling function in **CALCulate:SCALE:FUNCTion**.

Parameter	Typical Return
-1.0E+15 to -1.0E-15, 0.0, +1.0E-15 to 1.0E+15. Default: 0.0.	+5.00000000E+00
Enable <i>Mx-B</i> scaling with a gain of 100 and an offset of 5. CALC:SCAL:FUNC SCAL CALC:SCAL:GAIN 100 CALC:SCAL:OFFS 5 CALC:SCAL:STAT ON	

- Applies only to the 34465A and 34470A.
- The instrument sets the offset value to 0.0 after a Factory Reset (***RST**) or Instrument Preset (**SYSTem:PRESet**).

CALCulate:SCALE:REFerence {<reference>|MIN|MAX|DEF}
CALCulate:SCALE:REFerence? [{MIN|MAX|DEF}]

Stores a reference value for the PCT function in **CALCulate:SCALE:FUNCTion**.

Parameter	Typical Return
-1.0E+15 to -1.0E-15, 0.0, +1.0E-15 to 1.0E+15. Default: 0.0.	+3.00000000E+02
Enable PCT scaling with a 100V reference. CALC:SCAL:REF 100 CALC:SCAL:FUNC PCT CALC:SCAL:STAT ON	

- Applies only to the 34465A and 34470A.
- Specifying a reference value disables automatic reference selection (**CALCu-late:SCALE:REFerence:AUTO OFF**).
- The instrument sets the reference value to 0.0 with automatic reference selection enabled after a Factory Reset (***RST**) or Instrument Preset (**SYSTem:PRESet**), or a change in measurement function.

CALCulate:SCALE:REFerence:AUTO {ON|1|OFF|0}
CALCulate:SCALE:REFerence:AUTO?

Enables or disables automatic reference selection for the dB scaling functions.

Parameter	Typical Return
{ON 1 OFF 0}. Default: ON.	0 (OFF) or 1 (ON)
Enable the DB function with automatic reference selection and use the first measurement as the reference value: CALC:SCAL:DBM:REF 50 CALC:SCAL:FUNC DB CALC:SCAL:REF:AUTO ON CALC:SCAL:STAT ON READ?	

- **ON:** the first measurement made is used as the reference for all subsequent measurements, and automatic reference selection is disabled:
 - For the dB scaling function, the first measurement is converted to dBm, and **CALCulate:SCALE:DB:REFerence** is set to the result.
 - For the PCT scaling function, **CALCulate:SCALE:REFerence** is set to the first measurement.
- **OFF:** **CALCulate:SCALE:DB:REFerence** specifies the reference for DB scaling, **CALCulate:SCALE:REFerence** specifies the reference for PCT scaling.
- The instrument enables automatic reference selection when the scaling function is enabled (**CALCulate:SCALE:STATe ON**).
- This parameter is set to its default value after a Factory Reset (***RST**), an Instrument Preset (**SYSTem:PRESet**), or a change in measurement function.
- You must execute **CALCulate:SCALE:FUNCTion** *before* executing **CALCulate:SCALE[:STATe]**, otherwise an incompatibility error will be generated.
- Scaling is set to OFF when you change measurement functions (for example, changing from DCV to ACV). You must re-enable scaling after changing measurement functions.

CALCulate:SCALE[:STATe] {ON|1|OFF|0}
CALCulate:SCALE[:STATe]?

Enables or disables the scaling function.

Parameter	Typical Return
{ON 1 OFF 0}. Default: OFF.	0 (OFF) or 1 (ON)
Enable the DB function with automatic reference selection and use the first measurement as the reference value: CALC:SCAL:DBM:REF 50 CALC:SCAL:FUNC DB CALC:SCAL:REF:AUTO ON CALC:SCAL:STAT ON READ?	

- Enabling the scaling function also enables automatic null value selection (**CALCulate:SCALE:REFERENCE:AUTO**).
- This parameter is set to its default value after a Factory Reset (***RST**), an Instrument Preset (**SYSTEM:PRESet**), or a change in measurement function.
- Scaling is set to OFF when you change measurement functions (for example, changing from DCV to ACV). You must re-enable scaling after changing measurement functions.

CALCulate:SCALE:UNIT <quoted_string>
CALCulate:SCALE:UNIT?

Allows you to specify the custom label of up to four characters (for example, RPM or °C) for scaled measurements.

Parameter	Typical Return
<quoted_string> A quoted ASCII string of up to four characters.	"RPM"
Enable scaling with a gain of 100 and an offset of 5, and display "PSI" with measurements on the front panel. CALC:SCAL:FUNC SCAL CALC:SCAL:GAIN 100 CALC:SCAL:OFFS 5 CALC:SCAL:UNIT "PSI" CALC:SCAL:UNIT:STAT ON CALC:SCAL:STAT ON	

- Applies only to the 34465A and 34470A.
- <quoted_string> You can use letters (A-Z), numbers (0-9), an underscore (_), most standard punctuation (comma, ampersand, ...), and some symbols, including the degree symbol (°).
- If you set the measurement label to °C, °F, or K, this has no effect the temperature units set using **UNIT:TEMPerature**.

- **CALCulate:SCALE:UNIT:STATe** controls whether the unit string is displayed when the scaling function is enabled.
- The instrument resets the units to the null string after a Factory Reset (***RST**) or an Instrument Preset (**SYSTem:PRESet**).

CALCulate:SCALE:UNIT:STATe {OFF|ON}

CALCulate:SCALE:UNIT:STATe?

Enables or disables displaying the unit string with measurements on the front panel when the scaling function is enabled.

Parameter	Typical Return
{ON 1 OFF 0}. Default: OFF.	0 (OFF) or 1 (ON)
Enable scaling with a gain of 100 and an offset of 5, and display "PSI" with measurements on the front panel. CALC:SCAL:FUNC SCAL CALC:SCAL:GAIN 100 CALC:SCAL:OFFS 5 CALC:SCAL:UNIT "PSI" CALC:SCAL:UNIT:STAT ON CALC:SCAL:STAT ON	

- Applies only to the 34465A and 34470A.
- **CALCulate:SCALE:UNIT** specifies the unit string to be displayed.
- The instrument disables displaying the unit string after a Factory Reset (***RST**) or an Instrument Preset (**SYSTem:PRESet**).

CALCulate:AVERage Subsystem

This subsystem calculates measurement statistics.

Command Summary

CALCulate:AVERage:ALL?

CALCulate:AVERage:AVERage?

CALCulate:AVERage:CLEar[:IMMEDIATE]

CALCulate:AVERage:COUNT?

CALCulate:AVERage:MAXimum?

CALCulate:AVERage:MINimum?

CALCulate:AVERage:PTPeak?

CALCulate:AVERage:SDEVIation?

CALCulate:AVERage[:STATE]

CALCulate:AVERage:ALL?

CALCulate:AVERage:AVERage?

CALCulate:AVERage:COUNT?

CALCulate:AVERage:MAXimum?

CALCulate:AVERage:MINimum?

CALCulate:AVERage:PTPeak?

CALCulate:AVERage:SDEviation?

The CALCulate:AVERage:ALL? query returns the arithmetic mean (average), standard deviation, minimum value and maximum value of all measurements taken since the statistics were last cleared. The count and peak-to-peak statistics are not returned by CALCulate:AVERage:ALL?.

The other six queries listed above return individual values.

Parameter	Typical Return
(none)	(see below)
Return the statistics of 100 frequency measurements: CONF:FREQ 1.0E3,.001 SAMP:COUN 100 CALC:AVER:STAT ON INIT *WAI CALC:AVER:ALL? Typical Response: +1.00520000E+03,+1.00512000E+03,+1.00527000E+03,+4.13500000E-01	

- Statistics are cleared when the measurement function changes or when any of these commands is executed:

CALCulate:AVERage:STATe ON

CALCulate:AVERage:CLEar

INITiate

MEASure:<function>?

READ?

*RST

SYSTem:PRESet

- All values are returned in the form +1.23450000E+01.
- When dB or dBm scaling is used, the CALC:AVER:AVER and CALC:AVER:SDEV queries return +9.91000000E+37 (not a number).

CALCulate:AVERage:CLEar[:IMMEDIATE]

Clears all computed statistics: minimum, maximum, average, peak-to-peak, count and standard deviation.

Parameter	Typical Return
(none)	(none)
Clear the stored statistical data: CALC:AVER:CLE	

- Does not clear measurements in reading memory.
- Statistics are cleared when the measurement function changes or when any of these commands is executed:

CALCulate:AVERage:STATe ON

CALCulate:AVERage:CLEar

INITiate

MEASure:<function>?

READ?

*RST

SYSTem:PRESet

- To clear statistics, limits, histogram data, and measurement data, use CALCulate:CLEar[:IMMEDIATE].

CALCulate:AVERage[:STATe] {ON|1|OFF|0}

CALCulate:AVERage[:STATe]?

Enables or disables statistics computation.

Parameter	Typical Return
{ON 1 OFF 0}. Default: OFF.	0 (OFF) or 1 (ON)
Return the statistics of 100 frequency measurements: CONF:FREQ 1.0E3,.001 SAMP:COUN 100 CALC:AVER:STAT ON INIT *WAI CALC:AVER:ALL? Typical Response: +1.00520000E+03,+1.00512000E+03,+1.00527000E+03,+4.13500000E-01	

- Statistics are cleared when the measurement function changes or when any of these commands is executed:

CALCulate:AVERage:STATe ON

CALCulate:AVERage:CLEar

INITiate

MEASure:<function>?

READ?

*RST

SYSTem:PRESet

- The instrument turns this setting OFF when the measurement function is changed or after *RST or SYSTem:PRESet.

CALCulate:SMOothing Subsystem

This subsystem controls the smoothing (moving average) filter. This subsystem applies only to the 34465A and 34470A.

Command Summary

CALCulate:SMOothing:RESPonse

CALCulate:SMOothing[:STATe]

CALCulate:SMOothing:RESPonse {SLOW|MEDIum|FAST}

CALCulate:SMOothing:RESPonse?

Selects the number of measurements to be averaged by the moving average (boxcar) filter.

Parameter	Typical Return
{SLOW MEDIum FAST} SLOW = 100 measurements, MEDIum = 50 measurements, FAST = 10 measurements. Default: 10 measurements.	SLOW
Enable a 50-point moving average filter on 1000 measurements: CONF:VOLT 10 SAMP:COUN 1000 CALC:SMO:RESP MED CALC:SMO:STAT ON CALC:STAT ON READ?	
Typical Response: +9.99383828200000E+00,+9.99352315400000E+00,... (1000 measurements)	

- Applies only to the 34465A and 34470A.
- The smoothing (moving average) filter produces one result for each measurement made.
- The smoothing (moving average) filter is reset when the measurement function changes, by **INITiate:IMMEDIATE**, **READ?**, or **MEASure?**, or if a reading is too far beyond the current average.
- After the smoothing (moving average) filter is reset, the filter produces results which are the average of all measurements made after the reset, until the required number of measurements are made as selected by **CALCulate:SMOothing:RESPonse**. Once the required number measurements are made, the results are the moving average of the last 10, 50, or 100 measurements. Equal weighting is applied to all measurements used in the average.
- The instrument sets the response time to FAST after a Factory Reset (***RST**) or after an Instrument Preset (**SYSTem:PRESet**).

CALCulate:SMOothing[:STATe] {OFF|ON}
CALCulate:SMOothing[:STATe]?

Enables or disables a smoothing (moving average) filter on the measurements. Smoothing is intended to average out small variations in the measurements. Larger variations will cause the filter to reset.

Parameter	Typical Return
{ON 1 OFF 0}. Default: ON.	0 (OFF) or 1 (ON)
Enable a 50-point moving average filter on 1000 measurements: CONF:VOLT 10 SAMP:COUN 1000 CALC:SMO:RESP MED CALC:SMO:STAT ON CALC:STAT ON READ? Typical Response: +9.99383828200000E+03,+9.99352315400000E+03,... (1000 measurements)	

- Applies only to the 34465A and 34470A.
- The **CALCulate** subsystem and the individual calculate functions are disabled for timestamp measurements.
- The instrument disables the smoothing (moving average) filter after a Factory Reset (***RST**) or an Instrument Preset (**SYSTem:PRESet**).

CALCulate:TCHart[:STATe] {ON|1|OFF|0}
CALCulate:TCHart[:STATe]?

Enables or disables trend chart data when controlling the instrument from remote.

Parameter	Typical Return
{OFF ON 0 1}. Default: OFF.	OFF or ON
Enable trend chart data on 500 measurements: CALCulate:TCHart:STATe ON CONF:VOLT:DC 10,0.003 SAMP:COUN 500 INIT FETC? Typical Response: +9.99383828200000E+00,+9.99352315400000E+00,... (500 measurements)	

- You must enable this (ON) *before* sending **INIT** or **READ?** to see trend chart data when controlling the instrument from remote. If it is disabled or enabled *after* **INIT** or **READ?**, viewing the trend chart results in a chart with no data.
- Trend chart data must be disabled (OFF) to make measurements at the highest speed (50 kHz).
- This parameter is set to its default value after a Factory Reset (***RST**) or Instrument Preset (**SYSTem:PRESet**).

CALibration Subsystem

NOTE

Read the **calibration procedure** before calibrating. Improper calibration can reduce accuracy and reliability.

CALibration:ADC?

CALibration[:ALL]?

CALibration:COUNT?

CALibration:DATE?

CALibration:SECure:CODE

CALibration:SECure:STAtE

CALibration:STORe

CALibration:STRing

CALibration:TEMPerature?

CALibration:TIME?

CALibration:VALue

CALibration:ADC?

Performs a low-level calibration of the ADC (analog-to-digital converter) circuitry.

NOTE

You must unsecure the instrument to calibrate it or to change the calibration code or security code.

Parameter	Typical Return
(none)	0 (successful) or 1 (unsuccessful)
Calibrate the ADC:	
CAL:ADC?	

- This is the first step in a re-calibration sequence, and must be done before doing the offset calibration.

CALibration[:ALL]?

Performs a calibration using the calibration value based on the function and range (CALibration:VALue). A short must be applied for the resistance and voltage measurement functions, and the inputs must be open for the current measurement functions.

NOTE You must unsecure the instrument to calibrate it or to change the calibration code or security code.

Parameter	Typical Return
(none)	+0 (pass) or +1 (fail)
Perform a zero calibration of the ACV measurement function and return a pass/fail indication:	
CONF:VOLT:AC	
CAL:SEC:STAT OFF,MY_CAL_CODE	
CAL:VAL 0.0	
CAL?	
CAL:STOR	
CAL:SEC:STAT ON	

- This query increments the instrument’s calibration count (CALibration:COUNT?) and modifies the volatile version of the calibration constants. Use CALibration:STORe to save these constants in non-volatile memory at end of calibration.

CALibration:COUNT?

Returns the calibration count. Read and record the initial count when you first receive your instrument.

Parameter	Typical Return
(none)	+117
Return the calibration count:	
CAL:COUN?	

- Because the value increments each time you store the calibration constants, a complete calibration adds many counts. The calibration count also increments whenever you save a calibration string, change the calibration password, or override the calibration security.
- You can perform this query regardless of whether the instrument is secured.
- This setting is non-volatile; it will not be changed by power cycling or *RST or SYSTem:PRESet.

See Also

SYSTem:SECurity:COUNT?

CALibration:DATE?

Returns the date of the last calibration in the format *yyyy,mm,dd*.

Parameter	Typical Return
(none)	2014,4,26
Return the calibration date: CAL:DATE?	

- You can perform this query regardless of whether the instrument is secured.
- The date is based on the instrument's real-time clock. Set the date for the instrument's real-time clock with **SYSTem:DATE** and **SYSTem:TIME**.
- This setting is non-volatile; it will not be changed by power cycling or ***RST** or **SYSTem:PRESet**.

See Also

SYSTem:DATE

SYSTem:TIME

CALibration:SECure:CODE <new_code>

Sets the security code (calibration password) to prevent unauthorized calibrations.

NOTE You must unsecure the instrument to calibrate it or to change the calibration code or security code.

Parameter	Typical Return
Unquoted string up to 12 characters Must start with letter (A-Z) May contain letters, numbers (0-9) and underscores	(none)
Set new security code (calibration password): CAL:SEC:STAT OFF,OLD_CAL_CODE CAL:SEC:CODE TST_DUT165 CAL:SEC:STAT ON	

- To change the code: unsecure calibration memory with the old code, then set the new code.
- If you forget your security code, see **Security Code Override**.
- When shipped from the factory, the instrument is secured, with the security code (calibration password) set to **AT3446XA**.
- This setting is non-volatile; it will not be changed by power cycling or ***RST** or **SYSTem:PRESet**.

**CALibration:SECure:STATe {ON|1|OFF|0}[, <code>]
CALibration:SECure:STATe?**

Unsecures or secures the instrument for calibration.

NOTE You must unsecure the instrument to calibrate it or to change the calibration code or security code.

Parameter	Typical Return
{ON 1 OFF 0}. Default: ON.	0 (OFF) or 1 (ON)
Unsecure calibration:	
CAL:SEC:STAT OFF,MY_CODE_272	
Secure calibration:	
CAL:SEC:STAT ON	

- The <code> is optional to secure the instrument, but must be correct if provided.
- When shipped from the factory, the instrument is secured, with the security code (calibration password) set to **AT3446XA**.
- Front panel and remote interface calibration share the same code.
- This setting is non-volatile; it will not be changed by power cycling or ***RST** or **SYSTem:PRESet**.

CALibration:STORe

Takes calibration constants in volatile memory (**CALibration:ALL?**), and places them in nonvolatile memory, where they are not changed by cycling power, ***RST**, or **SYSTem:PRESet**. Do this at the end of calibration to avoid losing changes.

NOTE You must unsecure the instrument to calibrate it or to change the calibration code or security code.

Parameter	Typical Return
(none)	(none)
Store calibration constants into non-volatile memory:	
CAL:STOR	

CALibration:STRing "<string>"
CALibration:STRing?

Stores a message in calibration memory. Common messages include the last calibration date, calibration due date, or calibration department contact information. You can perform this query regardless of whether the instrument is secured.

NOTE You must unsecure the instrument to calibrate it or to change the calibration code or security code.

Parameter	Typical Return
Quoted string up to 40 characters May contain letters, numbers, spaces, and other common characters.	"FOR CAL HELP, CALL JOE AT EXT 1234" (If no string stored, returns "")
CAL:STR "FOR CAL HELP, CALL JOE AT EXT 1234"	

- This string may be stored only from the remote interface, but you can read the message from the front panel or remote interface.
- Storing a calibration message overwrites the previous message.
- This setting is non-volatile; it will not be changed by power cycling or ***RST** or **SYSTem:PRESet**.

CALibration:TEMPerature?

Returns the temperature of the last calibration in °C.

Parameter	Typical Return
(none)	+2.42850208E+001
Return the calibration temperature: CAL:TEMP?	

- You can perform this query regardless of whether the instrument is secured.
- This setting is non-volatile; it will not be changed by power cycling or ***RST** or **SYSTem:PRESet**.

CALibration:TIME?

Returns the amount of time since the last calibration in the format *hh,mm,ss.sss*.

Parameter	Typical Return
(none)	20,15,30.000
Return the calibration time: CAL:TIME?	

- You can perform this query regardless of whether the instrument is secured.
- This setting is non-volatile; it will not be changed by power cycling or ***RST** or **SYSTem:PRESet**.

See Also

SYSTem:TIME

SYSTem:DATE

CALibration:VALue <value>

CALibration:VALue?

Specifies the value of the applied calibration signal.

NOTE You must unsecure the instrument to calibrate it or to change the calibration code or security code.

Parameter	Typical Return
Numeric, default 0.0	+2.37000000E-02
Specify calibration value 0.0237: CAL:VAL 2.37E-2	

- This parameter is set to its default value after a Factory Reset (***RST**) or Instrument Preset (**SYSTem:PRESet**).

CONFigure Subsystem

The CONFigure commands are the most concise way to configure measurements. Like the **MEASure?** queries, these commands use default measurement configuration values. However, these commands do not automatically start measurements, so you can modify measurement attributes before initiating the measurement.

NOTE Use **INITiate** or **READ?** to initiate measurements.

Command Summary

- CONFigure?
- CONFigure:CAPacitance
- CONFigure:CONTInuity
- CONFigure:CURREnt:{AC|DC}
- CONFigure:DIODE
- CONFigure:{FREQuency|PERiod}
- CONFigure:{RESistance|FRESistance}
- CONFigure:TEMPerature
- CONFigure[:VOLTage]:{AC|DC}
- CONFigure[:VOLTage][:DC]:RATio

Default Settings for the CONFigure Command

The CONFigure commands select the function, range and resolution in one command. Specify *<resolution>* in the measurement's units (V, A, Hz, Ω, and so on). All other parameters are set to their default values (below).

Measurement Parameter	Default Setting
AC Input Filter (bandwidth)	20 Hz (medium filter)
Autozero	OFF if resolution setting results in NPLC < 1 ON if resolution setting results in NPLC ≥ 1
Range	AUTO (including voltage range for frequency and period measurements)
Samples per Trigger	1 sample
Trigger Count	1 trigger
Trigger Delay	Automatic delay
Trigger Source	Immediate
Trigger Slope	NEGative
Math Functions	Disabled. Other parameters are unchanged.
Per-function Null State	Disabled

Using CONFigure

The following example uses CONFigure and READ? to make an externally-triggered measurement. CONFigure specifies DC voltage measurements but does not place the instrument in the "wait-for-trigger" state.

READ? places the instrument in the "wait-for-trigger" state, initiates a measurement when the rear-panel Ext Trig input is pulsed (low by default), stores the measurement in reading memory, and transfers the measurement to the instrument's output buffer. The default range (autorange) and resolution (10 PLC) are used for the measurement.

```
CONF:VOLT:DC
TRIG:SOUR EXT
READ?
```

Typical Response: +4.27150000E+00

The following example is like the previous one, but it uses INITiate and FETCh? instead of READ?. The INITiate command places the instrument in the "wait-for-trigger" state, triggers a measurement when the rear-panel Ext Trig input is pulsed (low by default), and sends the measurement to reading memory. The FETCh? query transfers the measurement from reading memory to the instrument's output buffer.

```
CONF:VOLT:DC
TRIG:SOUR EXT
INIT
FETC?
```

Typical Response: +5.34250000E+00

Storing measurements in reading memory with INITiate is faster than sending measurements to the instrument's output buffer using READ? (provided you do not send FETCh? until done). The INITiate command is also an "overlapped" command. This means that after executing INITiate, you can send other commands that do not affect the measurements. This allows you to check for data availability before initiating a read attempt that might otherwise time out. The FETCh? query waits until all measurements are complete to terminate. You can store up to 1,000 measurements in the reading memory of the 34460A, 10,000 measurements on the 34461A, 50,000 measurements on the 34465A/70A (*without* the MEM option), or 2,000,000 measurements on the 34465A/70A (*with* the MEM option).

The following example configures the instrument for 2-wire resistance measurements, triggers the instrument to make one measurement using INITiate, and stores the measurement in reading memory. The 10 k Ω range is selected with 100 Ω resolution.

```
CONF:RES 10000,100
INIT
FETC?
```

Typical Response: +5.95850000E+03

CONFigure?

Returns a quoted string indicating the present function, range, and resolution. The short form of the function name (CURR:AC, FREQ) is always returned.

Parameter	Typical Return
(none)	"VOLT +1.00000000E+01,+3.00000000E-06"
Return the present function, range, and resolution: CONF?	

CONFigure:CAPacitance [{<range>|AUTO|MIN|MAX|DEF} [, {<resolution>|MIN|MAX|DEF}]]

Sets all measurement and trigger parameters to their **default values** for capacitance measurements. Also specifies the range.

Parameter	Typical Return
<range>: {1 nF 10 nF 100 nF 1 µF 10 µF 100 µF}. Default: AUTO.	(none)
<resolution>: optional and ignored; fixed at 4½ digits.	
Configure capacitance measurements using the 1 µF range. Make and read two measurements: CONF:CAP SAMP:COUN 2 READ? Typical Response: +3.01574316E-10,+3.01659030E-10	

- You can let autoranging select the measurement range, or you can manually select a fixed range. Autoranging conveniently selects the range for each measurement based on the input signal. For fastest measurements, use manual ranging (autoranging may require additional time for range selection).
- Autoranging (AUTO or DEFault), will generate an error if you specify a <resolution> because the instrument cannot accurately resolve the integration time (especially if the input continuously changes). If your application requires autoranging, specify DEFault for the <resolution> or omit the <resolution> altogether.
- Autoranging goes down a range at less than 10% of range and up a range at greater than 120% of range. For capacitance measurements only, when autorange is off, the instrument does not report an overload for readings greater than 120% of range. Overload only occurs when the algorithm times out because the applied capacitance is too large for the algorithm to measure. If you apply a DC voltage or a short to the input terminals in capacitance measurement mode, the instrument reports an overload.
- If the input signal is greater than can be measured on the specified manual range, the instrument displays the word *Overload* on front panel and returns "9.9E37" from the remote interface.
- Use **READ?** or **INITiate** to start the measurement.

CONFigure:CONTInuity

Sets all measurement parameters and trigger parameters to their **default values** for continuity measurements.

Parameter	Typical Return
(none)	+1.32130000E-02
Configure the instrument for continuity measurements. Then make a measurement using an external trigger with positive slope (rising edge) and read the measurement: CONF:CONT TRIG:SOUR EXT;SLOP POS READ?	

- The range and resolution are fixed at 1 kΩ for continuity tests (a 2-wire resistance measurement).
- The instrument beeps (if the beeper is enabled) for each measurement less than or equal to the continuity threshold ($\leq 10 \Omega$), and the actual resistance measurement appears on the display.
- From 10 Ω to 1.2 kΩ, the instrument displays the actual resistance measurement with no beep. Above 1.2 kΩ, the instrument displays "OPEN" with no beep.
- The **FETCh?**, **READ?**, and **MEASure:CONTInuity?** queries return the measured resistance, regardless of its value.
- Use **READ?** or **INITiate** to start the measurement.

CONF:CURR:{AC|DC} [{<range>|AUTO|MIN|MAX|DEF} [, {<resolution>|MIN|MAX|DEF}]]

Sets all measurement parameters and trigger parameters to their **default values** for AC or DC current measurements. Also specifies the range and resolution.

Parameter	Typical Return
<range>: {100 μ A 1 mA 10 mA 100 mA 1 A 3 A 10 A}. Default: AUTO (autorange).	(none)
<resolution> (AC): optional and ignored; fixed at 6½ digits.	
<resolution> (DC): See Resolution Table or Range, Resolution and NPLC . The default is equivalent to 10 PLC. Specify <resolution> in the measurement's units (V, A, Hz, Ω , and so on).	
Configure AC current measurements using the 1 A range. Make and read two measurements: CONF:CURR:AC 1 SAMP:COUN 2 READ? Typical Response: +8.54530000E-01,+8.54520000E-01 Configure DC current measurements using the 1 A range with 1 mA resolution. Then make a measurement using an external trigger with positive slope (rising edge) and read the measurement: CONF:CURR:DC 1,0.001 TRIG:SOUR EXT;SLOP POS INIT FETC? Typical Response: +4.27150000E-01	

- Choosing the 10 A range automatically sets the [SENSe:]CURRent:{AC|DC}:TERMinals parameter to 10 A, and setting the range to 3 A or less sets the [SENSe:]CURRent:{AC|DC}:TERMinals parameter to 3 A.
- For the 34461A/65A/70A, when the Front/Rear switch is set to Front, setting the range to MAX selects the 10A range and the 10A terminals. When the Front/Rear switch is set to Rear, setting the range to MAX selects the 3A range and 3A terminals.
- You can let autoranging select the measurement range, or you can manually select a fixed range. Autoranging conveniently selects the range for each measurement based on the input signal. For fastest measurements, use manual ranging (autoranging may require additional time for range selection).
- Autoranging (AUTO or DEFault), will generate an error if you specify a <resolution> because the instrument cannot accurately resolve the integration time (especially if the input continuously changes). If your application requires autoranging, specify DEFault for the <resolution> or omit the <resolution> altogether.
- Autoranging goes down a range at less than 10% of range and up a range at greater than 120% of range.
- If the input signal is greater than can be measured on the specified manual range, the instrument displays the word *Overload* on front panel and returns "9.9E37" from the remote interface.
- To control the measurement rate for AC measurements, change the trigger delay or AC filter band-

width.

- Use **READ?** or **INITiate** to start the measurement.

See Also

CONFigure?

MEASure:CURRent:{AC|DC}?

[SENSe:]CURRent:AC:BANDwidth

CONFigure:DIODe

Sets all measurement parameters and trigger parameters to their **default values** for diode tests.

Parameter	Typical Return
(none)	(none)
Configure, make, and read a default diode measurement: CONF:DIOD READ? Typical Response: +1.32130000E-01	

- The range and resolution are *fixed* for diode tests: the range is 1 VDC (with a 1 mA current source output).
- The voltage is displayed on the front panel if it is between 0 and 5.05 V. The instrument beeps when the signal transitions into the range between 0.3 and 0.8 V (unless beeper is disabled). If the signal exceeds 5.05 V, the front panel shows "OPEN", and the value returned from SCPI is 9.9E37.
- The **FETCh?**, **READ?**, and **MEASure:DIODe?** queries return the measured voltage, regardless of its value.
- Use **READ?** or **INITiate** to start the measurement.

CONFigure:{FREQUENCY|PERIOD} [{<range>|MIN|MAX|DEF} [, {<resolution>|MIN|MAX|DEF}]]

Sets all measurement and trigger parameters to their **default values** for frequency or period measurements. Also specifies the *frequency* or *period* range and resolution.

Parameter	Typical Return
<range>: 3 Hz to 300 kHz. Default: 20 Hz. (FREQUENCY)	(none)
<range>: 3.33 μs to 333.33 ms. Default: 50 ms (PERIOD).	
<resolution>: See table below. Specify <resolution> in the measurement's units (V, A, Hz, Ω, and so on).	
Configure frequency measurements using the default aperture and the 200 Hz (fast) AC filter. Then make and read one measurement: CONF:FREQ FREQ:RANG:LOW 200 READ? Typical Response: +1.32130000E+03	

- The 1 ms aperture applies only to the 34465A and 34470A.
- The frequency or period <range> parameter is required only to specify the measurement resolution parameter. It is not necessary to send a new command for each new frequency or period to be measured. The <range> and <resolution> parameters affect the aperture (gate time) as follows:

Resolution (34460A/61A)	Resolution (34465A/70A)	Aperture
Not Applicable	100 ppm × <range> (MAXimum)	1 ms
100 ppm × <range> (MAXimum)	10 ppm × <range> (DEFault)	10 ms
10 ppm × <range> (DEFault)	1 ppm × <range>	100 ms
1 ppm × <range> (MINimum)	0.1 ppm × <range> (MINimum)	1 s

- The input signal for frequency or period measurements has an AC voltage component. Use [SENSe:]{FREQUENCY|PERIOD}:VOLTage:RANGe:AUTO to disable or enable voltage autoranging or use CONFigure:{FREQUENCY|PERIOD} to select voltage autoranging by default. Use [SENSe:]{FREQUENCY|PERIOD}:VOLTage:RANGe to select a fixed voltage range for frequency and period measurements.
- If the input voltage is too large for the selected voltage range (manual ranging), the instrument displays the word Overload on the front panel and returns "9.9E37" from the remote interface. Autoranging can be enabled for the input voltage.
- Use READ? or INITiate to start the measurement.

See Also

CONFigure?

MEASure:{FREQUENCY|PERIOD}?

CONFigure:{RESistance|FRESistance} [{<range>|AUTO|MIN|MAX|DEF} [, {<resolution>|MIN|MAX|DEF}]]

Sets all measurement parameters and trigger parameters to their **default values** for 4-wire (FRESistance) or 2-wire (RESistance) resistance measurements. Also specifies the range and resolution.

Parameter	Typical Return
<range>: 100 Ω, 1 kΩ, 10 kΩ, 100 kΩ, 1 MΩ, 10 MΩ, 100 MΩ, 1 GΩ, AUTO, or DEFault. Default: AUTO.	+8.54530000E+01
<resolution>: See Resolution Table or Range, Resolution and NPLC . The default is equivalent to 10 PLC. Specify <resolution> in the measurement's units (V, A, Hz, Ω, and so on).	
Configure 4-wire resistance measurements using the 100 Ω range with default resolution. Make and read two measurements: CONF:FRES 100 SAMP:COUN 2 READ? Typical Response: +8.54530000E+01,+8.54520000E+01	

- The 1 GΩ range applies only to the 34465A and 34470A.
- You can let autoranging select the measurement range, or you can manually select a fixed range. Autoranging conveniently selects the range for each measurement based on the input signal. For fastest measurements, use manual ranging (autoranging may require additional time for range selection).
- Autoranging (AUTO or DEFault), will generate an error if you specify a <resolution> because the instrument cannot accurately resolve the integration time (especially if the input continuously changes). If your application requires autoranging, specify DEFault for the <resolution> or omit the <resolution> altogether.
- Autoranging goes down a range at less than 10% of range and up a range at greater than 120% of range.
- If the input signal is greater than can be measured on the specified manual range, the instrument displays the word *Overload* on front panel and returns "9.9E37" from the remote interface.
- Use **READ?** or **INITiate** to start the measurement.

See Also

CONFigure?

MEASure:{RESistance|FRESistance}?

CONF:TEMPerature [{FRTD|RTD|FTHermistor|THERmistor|TCouple|DEFAULT} [, {<type>|DEFAULT} [,1 [, {<resolution>|MIN|MAX|DEF}]]]]

Sets all measurement parameters and trigger parameters to their **default values** for temperature measurements. Also specifies the transducer and the measurement resolution.

Parameter	Typical Return
<probe_type>: {FRTD RTD FTHermistor THERmistor TCouple}. Default: FRTD.	+2.12320000E+01
<type>: 85 (only possible value for RTD/FRTD), 5000 (only possible value for THERmistor/FTHermistor), or E, J, K, N, R, T (TCouple).	
<resolution>: See Resolution Table or Range, Resolution and NPLC . The default is equivalent to 10 PLC.	
Configure a 4-wire RTD measurement. Then make a measurement using an external trigger with positive slope (rising edge) and read the measurement: CONF:TEMP FRTD,85 TRIG:SOUR EXT;SLOP POS READ?	

- Thermocouple measurements (TC) apply only to the 34465A and 34470A.
- For temperature measurements, the instrument internally selects the range; you cannot select the range to be used.
- The <resolution> parameter only determines the integration time; it does not specify the resolution of the temperature measurement. This parameter is optional; however, if you specify <resolution>, you must also specify "1" as the implied range parameter. For example: CONF:TEMP RTD,85,1,0.000001 selects the 10 PLC integration time on the 34461A.
- To change temperature units, use **UNIT:TEMPerature**.
- For RTD and thermistor measurements, the instrument autoranges to the correct range for the transducer resistance measurement. For thermocouple measurements, the 100 mV range is selected.
- For thermocouple measurements, the internal reference is selected. See **SENSe:TEMPerature:TCouple:RJUNction:TYPE**.
- If the input signal is greater than can be measured on the specified manual range, the instrument displays the word *Overload* on front panel and returns "9.9E37" from the remote interface.
- Use **READ?** or **INITiate** to start the measurement.

CONFigure[:VOLTage]:{AC|DC} [{<range>|AUTO|MIN|MAX|DEF} [, {<resolution>|MIN|MAX|DEF}]]

Sets all measurement parameters and trigger parameters to their **default values** for AC or DC voltage measurements. Also specifies the range and resolution.

WARNING The maximum range parameter (MAX) is 1000 V. However, the SAFETY LIMIT on the front and rear HI/LO input terminals is 750 VAC (rms). The rms voltage is waveform dependent. A sine wave is limited to 750 VAC (rms), but a 1000 Vpk square wave is safe. Connection to AC mains power is further limited to CAT II (300 V). See **Safety and Regulatory Information** for more information on the safety features and the safe operation of this instrument.

Parameter	Typical Return
<range>: {100 mV 1 V 10 V 100 V 1000 V}. Default: AUTO (autorange).	(none)
<resolution> (AC): optional and ignored; fixed at 6½ digits.	
<resolution> (DC): See Resolution Table or Range, Resolution and NPLC . The default is equivalent to 10 PLC. Specify <resolution> in the measurement's units (V, A, Hz, Ω, and so on).	
Configure AC voltage measurements using the 100 V range. Make and read two measurements: CONF:VOLT:AC 100 SAMP:COUN 2 READ? Typical Response: +8.54530000E+01,+8.54520000E+01 Configure DC voltage measurements using the 10 V range with 1 mV resolution. Then make a measurement using an external trigger with positive slope (rising edge) and read the measurement: CONF:VOLT:DC 10,0.001 TRIG:SOUR EXT;SLOP POS INIT FETC? Typical Response: +4.27150000E+00	

- You can let autoranging select the measurement range, or you can manually select a fixed range. Autoranging conveniently selects the range for each measurement based on the input signal. For fastest measurements, use manual ranging (autoranging may require additional time for range selection).
- Autoranging (AUTO or DEFault), will generate an error if you specify a <resolution> because the instrument cannot accurately resolve the integration time (especially if the input continuously changes). If your application requires autoranging, specify DEFault for the <resolution> or omit the <resolution> altogether.
- Autoranging goes down a range at less than 10% of range and up a range at greater than 120% of range.
- If the input signal is greater than can be measured on the specified manual range, the instrument displays the word *Overload* on front panel and returns "9.9E37" from the remote interface.
- To control the measurement rate for AC measurements, change the trigger delay or AC filter band-

width.

- Use `READ?` or `INITiate` to start the measurement.

See Also

`CONFigure?`

`MEASure[:VOLTage]:{AC|DC}?`

`[SENSe:]CURREnt:AC:BANDwidth`

CONFigure[:VOLTage][:DC]:RATio [{<range>|AUTO|MIN|MAX|DEF} [, {<resolution>|MIN|MAX|DEF}]]

Sets all measurement and trigger parameters to their **default values** for DC voltage to DC voltage ratio measurements. Also specifies the range and resolution.

To calculate a ratio, the instrument measures a DC reference voltage applied to the *Sense* terminal and the DC signal voltage applied to the *Input* terminals. It then uses the formula:

$$\text{Ratio} = \text{DC signal voltage} / \text{DC reference voltage}$$

Parameter	Typical Return
<range>: {100 mV 1 V 10 V 100 V 1000 V}. Default: AUTO (autorange).	(none)
<resolution>: See Resolution Table or Range, Resolution and NPLC . The default is equivalent to 10 PLC.	
Configure the instrument for DC voltage ratio measurements using the 100 V range with 1 mV resolution. Then make a measurement using an external trigger with positive slope (rising edge) and read the measurement: CONF:VOLT:DC:RAT 100,0.001 TRIG:SOUR EXT;SLOP POS INIT FETC? Typical Response: +4.27150000E+00	

- The *Sense* terminals have a maximum measurable input of ±12 VDC. Autoranging is automatically selected for reference voltage measurements on the *Sense* terminals.
- The *Input LO* and *Sense LO* terminals must have a common reference and cannot have a voltage difference greater than ±2 V.
- The specified measurement range applies only to the signal connected to the *Input* terminals. The signal on the *Input* terminals can be any DC voltage up to 1,000 V.
- For the *Input* terminals, you can allow the instrument to select the measurement range by autoranging or you can select a fixed range using *manual ranging*. Autoranging decides which range to use for each measurement based on the input signal. For faster measurements, use manual ranging on each measurement (additional time is required for autoranging to select a range).
- Autoranging (AUTO or DEFault), will generate an error if you specify a <resolution> because the instrument cannot accurately resolve the integration time (especially if the input continuously changes). If your application requires autoranging, specify DEFault for the <resolution> or omit the <resolution> altogether.
- Autoranging goes down a range at less than 10% of range and up a range at greater than 120% of range.
- If the input signal is greater than can be measured on the specified manual range, the instrument displays the word *Overload* on front panel and returns "9.9E37" from the remote interface.
- Use **READ?** or **INITiate** to start the measurement.

See Also

CONFigure?

MEASure[:VOLTage][:DC]:RATio?

DATA Subsystem

This subsystem allows you to configure and remove data from reading memory. The instrument clears all measurements from reading memory when the measurement configuration changes, or when any of these commands are executed: **INITiate**, **MEASure:<function>?**, **READ?**, ***RST**, **SYSTem:PRESet**.

Command Summary

DATA:LAST?

DATA:POINts?

DATA:POINts:EVENT:THReshold

DATA:REMOve?

DATA:LAST?

Returns the last measurement taken. You can execute this query at any time, even during a series of measurements.

Parameter	Typical Return
(none)	(none)
Return the last measurement: DATA:LAST? Typical Response: One measurement with units. If no data is available, 9.91E37 (Not a Number) is returned with units. Example: +1.73730000E+00 VDC	

DATA:POINts?

Returns the total number of measurements currently in reading memory. You can execute this query at any time, even during a series of measurements.

Parameter	Typical Return
(none)	(none)
Return the number of measurements in reading memory: DATA:POIN? Typical Response: +215	

- You can store up to 1,000 measurements in the reading memory of the 34460A, 10,000 measurements on the 34461A, 50,000 measurements on the 34465A/70A (*without* the MEM option), or 2,000,000 measurements on the 34465A/70A (*with* the MEM option).

DATA:POINts:EVENT:THReshold <count>
DATA:POINts:EVENT:THReshold?

Sets the number of measurements to store in reading memory before setting bit 9 in the Standard Operation Register group event register to 1. An event register is a read-only register that latches events from the condition register. While an event bit is set, subsequent events corresponding to that bit are ignored.

NOTE For more information on the SCPI Status System, see [Status Subsystem Introduction](#).

Parameter	Typical Return
34460A: 1 to 1,000 readings 34461A: 1 to 10,000 readings 34465A/70A: 1 to 50,000 readings (without the MEM option), or 1 to 2,000,000 readings (with the MEM option) The default value is 1 for both models.	+125
Set the reading memory threshold to 125 measurements: DATA:POIN:EVENT:THR 125	

- To report any subsequent events, the measurement count must first drop below the programmed threshold before reaching the threshold again.
- Use [STATus:OPERation:ENABle](#) to enable the Memory Threshold bit (bit 9 in the Standard Operation Event register) to be reported to the Status Byte.
- Once the Memory Threshold bit (bit 9 in the Standard Operation Event register) is set, it remains set until cleared by [STATus:OPERation:EVENT?](#) or [*CLS](#).
- The Standard Operation Condition register shows the current condition. See [STATus Subsystem Introduction](#) for further information.
- This parameter is set to its default value after a Factory Reset ([*RST](#)) or Instrument Preset ([SYSTem:PRESet](#)).

DATA:REMove? <num_readings> [,WAIT]

Reads and erases <num_readings> measurements from the reading memory. If fewer than <num_readings> measurements are available, the query returns an error unless the WAIT parameter is specified, in which case the query waits until <num_readings> measurements are available.

Parameter	Typical Return
34460A: 1 to 1,000 readings 34461A: 1 to 10,000 readings 34465A/70A: 1 to 50,000 readings (without the MEM option), or 1 to 2,000,000 readings (with the MEM option)	(none)
Read and erase the three oldest readings from reading memory: DATA:REMove? 3 Typical Response: -4.97215654E-01,-4.97343268E-01,-4.97121213E-01	

- The **R?** and **DATA:REMove?** queries can be used during a long series of readings to periodically remove readings from memory that would normally cause the reading memory to overflow. **R?** does not wait for all readings to complete. It sends the readings that are complete at the time the instrument receives the command. Use **Read?** or **Fetch?** if you want the instrument to wait until all readings are complete before sending readings.
- You can store up to 1,000 measurements in the reading memory of the 34460A, 10,000 measurements on the 34461A, 50,000 measurements on the 34465A/70A (*without* the MEM option), or 2,000,000 measurements on the 34465A/70A (*with* the MEM option). If reading memory overflows, new measurements overwrite the oldest measurements stored; the most recent measurements are always preserved. No error is generated, but the Reading Mem Ovfl bit (bit 14) is set in the Questionable Data Register's condition register (see **Status System Introduction**).

DISPlay Subsystem

This subsystem controls the instrument's display.

Command Summary

DISPlay[:STATe]

DISPlay:TEXT[:DATA]

DISPlay:TEXT:CLEAr

DISPlay:VIEW

DISPlay[:STATe] {ON|1|OFF|0}

DISPlay[:STATe]?

Disables or enables the front panel display. When disabled, the display dims, and all annunciators are disabled. However, the screen remains on.

Parameter	Typical Return
{ON 1 OFF 0}. Default: ON.	0 (OFF) or 1 (ON)
Turn display off: DISP OFF	

- Disabling the display improves command execution speed from the remote interface and provides basic security.
- Sending **DISPlay:TEXT <string>** will display the text even with **DISP:STAT OFF**.
- The display is enabled when power is cycled, or when you return to local (front panel) operation by pressing the [Local] key.

DISPlay:TEXT[:DATA] "<string>"

DISPlay:TEXT[:DATA]?

Displays a text message on the front panel display.

Parameter	Typical Return
A quoted string of up to 40 characters. You can use letters (A-Z), numbers (0-9) and special characters such as @, %, *, and so forth. Default ""	"Test in progress..."
Show message on display: DISP:TEXT "Test in progress..."	

- Sending **DISPlay:TEXT <string>** will display the text even with **DISP:STAT OFF**.
- While a message is displayed, information relating to the current instrument operation is not sent to the front panel display.
- The display text is unaffected by ***RST**. It is cleared at power-on.

DISPlay:TEXT:CLEAr

Clears the text message from the display.

Parameter	Typical Return
(none)	(none)
Clear displayed message: DISP:TEXT:CLE	

- With **DISPlay ON**, DISP:TEXT:CLEAr returns the display to its normal mode.
- With **DISPlay OFF**, DISP:TEXT:CLEAr clears the message and the display remains disabled. To enable the display, send **DISPlay ON** or press the front panel **[Local]** key.
- The display text is unaffected by ***RST**. It is cleared at power-on.

DISPlay:VIEW {NUMeric|HISTogram|TCHart|METER} DISPlay:VIEW?

Specifies whether measurement data is displayed in numeric, histogram, trend chart (not available on the 34460A), or bar meter form.

Parameter	Typical Return
{NUMeric HISTogram TCHart METER}. Default: NUM.	HIST
Display histogram: DISP:VIEW HIST	

- The display is not turned on if the display state is OFF.
- This parameter is set to its default value after a Factory Reset (***RST**) or Instrument Preset (**SYSTem:PRESet**).

FORMat Subsystem

This subsystem applies only to the 34465A and 34470A.

Command Summary

FORMat:BORDER

FORMat[:DATA]

FORMat:BORDER {NORMal|SWAPped}

FORMat:BORDER?

Used for binary block transfers only. Selects the byte order for binary block transfers using MEASure?, READ?, FETCh?, DATA:REMove? and R?.

Parameter	Typical Return
{NORMal SWAPped} (see bullet points below). Default: NORM.	NORM
Select the swapped byte order: FORMat:BORDER SWAP	

- Applies only to the 34465A and 34470A.
- In the *NORMal* byte order (default) the most-significant byte (MSB) of each data point is assumed first.
- In the *SWAPped* byte order the least-significant byte (LSB) of each data point is assumed first. Most PCs use the "swapped" byte order.
- The byte order setting is stored in non-volatile memory and does not change when power has been off. The default value is restored after a Factory Reset (*RST), or after an Instrument Preset (SYSTem:PRESet).

FORMat[:DATA] {ASCIi|REAL} [, <length>]

FORMat[:DATA]?

Specifies the data format to be either ASCII or REAL. Affects the data format of the MEASure?, READ?, FETCh?, DATA:REMove? and R? commands only.

Parameter	Typical Return
<length> ASCIi: "9" or REAL: "64"	ASC,9
Specify the 64-bit REAL data format: FORM:DATA REAL,64 or FORM:DATA REAL	

- Applies only to the 34465A and 34470A.
- If ASCII is specified, numeric data is transferred as ASCII characters. The numbers are separated by commas as specified in IEEE 488.2. The `<length>` parameter is optional, but "9" is the default and only allowed value, and the instrument returns 9 significant digits (for example: +4.57553816E-05).
- If REAL is specified, numeric data is transferred as REAL binary data in IEEE 488.2 definite-length block format. The `<length>` parameter is optional, but "64" is the default and only allowed value. The byte order is controlled by **FORMat:BORe**.

HCOPy Subsystem

The HCOPy subsystem produces display images ("screen shots").

Example

The following example captures and returns the display image in BMP format.

```
HCOP:SDUM:DATA:FORM BMP
HCOP:SDUM:DATA?
```

HCOPy:SDUMp:DATA?

Returns the front panel display image ("screen shot").

Parameter	Typical Return
(none)	(A definite-length binary block containing the image.) A definite-length block allows data to be transmitted as a series of 8-bit data bytes. This is particularly useful for transferring large quantities of data or 8-bit extended ASCII codes.
See Example .	

- The image format (PNG or BMP) is specified by [HCOPy:SDUMp:DATA:FORMat](#).

HCOPy:SDUMp:DATA:FORMat {PNG|BMP}

HCOPy:SDUMp:DATA:FORMat?

Specifies the format for images returned by [HCOPy:SDUMp:DATA?](#).

Parameter	Typical Return
{PNG BMP}. Default: PNG.	PNG or BMP
See Example .	

IEEE 488.2 Common Commands

These commands and queries are associated with the IEEE 488.2 standard.

Command Summary

*CAL?

*CLS

*ESE

*ESR?

*IDN?

*LRN?

*OPC

*OPC?

*OPT?

*PSC

*RCL

*RST

*SAV

*SRE

*STB?

*TRG

*TST?

*WAI

Standard Event Register

The following table describes the Standard Event Register.

Bit Number	Bit Name	Decimal Value	Definition
0	Operation Complete	1	All commands prior to and including *OPC have been executed.
1	Not Used	2	0 is returned.
2	Query Error	4	The instrument tried to read the output buffer but it was empty. Or, a new command line was received before a previous query has been read. Or, both the input and output buffers are full.
3	Device-Specific Error	8	A device-specific error, including a self-test error or calibration error, occurred (an error in the -300 range or any positive error has been generated). See SCPI Error Messages for the complete SCPI error message list.
4	Execution Error	16	An execution error occurred (an error in the -200 range has been generated).
5	Command Error	32	A command syntax error occurred (an error in the -100 range has been generated).
6	Not Used	64	0 is returned.
7	Power On	128	Power has been cycled since the last time the event register was read or cleared.

Status Byte Register

The following table describes the Status Byte Register.

Bit Number	Bit Name	Decimal Value	Definition
0	Not Used	1	(Reserved for future use)
1	Not Used	2	(Reserved for future use)
2	Error Queue	4	One or more errors have been stored in the Error Queue. Use SYSTem:ERRor? to read and delete errors.
3	Questionable Data Summary	8	One or more bits are set in the Questionable Data Register (bits must be enabled, see STATus:QUEStionable:ENABle).
4	Message Available	16	Data is available in the instrument's output buffer.
5	Standard Event Summary	32	One or more bits are set in the Standard Event Register (bits must be enabled, see *ESE).
6	Master Summary	64	One or more bits are set in the Status Byte Register and may generate a Request for Service (RQS). Bits must be enabled using *SRE .
7	Standard Operation Summary	128	One or more bits are set in the Standard Operation Register (bits must be enabled, see STATus:OPERation:ENABle).

***CAL?**

Calibration Query. Performs autocalibration (autocal) and returns the result.

Parameter	Typical Return
(none)	+0 (no error) +1 (cal error)
Perform autocalibration, return result: *CAL?	

- (34465A/70A only)
- Autocalibration takes just a few seconds to complete.
- Autocalibration compensates for drift caused by time and temperature change in DC voltage and resistance measurements, and adjusts some aspects of other measurement functions.
- Following the autocalibration, the instrument returns to the instrument state that existed before the autocalibration.

***CLS**

Clear Status Command. Clears the event registers in all register groups. Also clears the error queue.

Parameter	Typical Return
(none)	(none)
Clear event register bits and error queue: *CLS	

***ESE <enable_value>**

***ESE?**

Event Status Enable Command and Query. Enables bits in the enable register for the **Standard Event Register** group. The selected bits are then reported to bit 5 of the Status Byte Register. An enable register defines which bits in the event register will be reported to the Status Byte register group. You can write to or read from an enable register.

NOTE For more information on the SCPI Status System, see **Status Subsystem Introduction**.

Parameter	Typical Return
Decimal sum of the bits in the register, default 0. For example, to enable bit 2 (value 4), bit 3 (value 8), and bit 7 (value 128), the decimal sum would be 140 (4 + 8 + 128). Default: 0.	+48
Configure 100 DC voltage measurements and enable the generation of an SRQ when the measurements complete: <pre>*CLS *ESE 1 *SRE 32 CONF:VOLT:DC SAMP:COUN 100 INIT *OPC</pre>	

- Use ***PSC** to control whether the Standard Event enable register is cleared at power on. For example, ***PSC 0** preserves the enable register contents through power cycles.
- ***CLS** clears the event register, but not the enable register.
- The <enable> setting is nonvolatile; it does not change after a Factory Reset (***RST**), Instrument Pre-set (**SYSTem:PRESet**), Status Preset (**STATus:PRESet**) or Clear Status (***CLS**).

***ESR?**

Standard Event Status Register Query. Queries the event register for the **Standard Event Register** group.

An event register is a read-only register that latches events from the condition register. While an event bit is set, subsequent events corresponding to that bit are ignored.

Parameter	Typical Return
(none)	+24
Read the event register (bits 3 and 4 are set):	
*ESR?	

- In order to be reported to the Status Byte Register, the corresponding bits in the enable register must be enabled by ***ESE**.
- Any or all conditions can be reported to the Standard Event summary bit through the enable register. To set the enable register mask, write a decimal value to the register using ***ESE**.
- Once a bit is set, it remains set until cleared by reading the event register or by sending ***CLS** (clear status).

***IDN?**

Identification Query. Returns the instrument's identification string.

Parameter	Typical Return
(none)	(see below)
Return the instrument's identification string: *IDN?	

- **For firmware revisions prior to 2.0**, the identification string contains these four comma separated fields:

Manufacturer name, Model number, Serial number, Revision code

If **SYSTem:IDENtify DEFault** is set, the returned string has the following format:

Agilent Technologies,34460A,<Serial Number>,h.ff.ff-pp.pp-mm.mm-gg.gg-bb-fp

Agilent Technologies,34461A,<Serial Number>,h.ff.ff-pp.pp-mm.mm-gg.gg-bb-fp

If **SYSTem:IDENtify HP34401A** is set, the returned string has the following format:

HEWLETT-PACKARD,34401A,<Serial Number>,h.ff.ff-pp.pp-mm.mm-gg.gg-bb-fp

Where:

h. - Hardware revision

ff.ff - Main firmware revision

pp.pp - Front panel firmware revision

mm.mm - Measurement board firmware revision

gg.gg - Measurement board FPGA revision

bb - Measurement board revision

fp - Front panel board revision

- **For firmware revision 2.0 and later**, the identification string contains these four comma separated fields:

Manufacturer name, Model number, Serial number, Revision code

If **SYSTem:IDENtify DEFault** is set, the returned string has the following format:

Keysight Technologies,34460A,<Serial Number>,h.ff.ff-pp.pp-mm.mm-gg.gg-bb-fp
Keysight Technologies,34461A,<Serial Number>,h.ff.ff-pp.pp-mm.mm-gg.gg-bb-fp
Keysight Technologies,34465A,<Serial Number>,h.ff.ff-pp.pp-mm.mm-gg.gg-bb-fp
Keysight Technologies,34470A,<Serial Number>,h.ff.ff-pp.pp-mm.mm-gg.gg-bb-fp

If **SYSTem:IDENtify AT34460A or AT34461A** is set, the returned string has the following format (34460A or 34461A only):

Agilent Technologies,34460A,<Serial Number>,h.ff.ff-pp.pp-mm.mm-gg.gg-bb-fp
Agilent Technologies,34461A,<Serial Number>,h.ff.ff-pp.pp-mm.mm-gg.gg-bb-fp

If **SYSTem:IDENtify HP34401A** is set, the returned string has the following format:

HEWLETT-PACKARD,34401A,<Serial Number>,h.ff.ff-pp.pp-mm.mm-gg.gg-bb-fp

If **SYSTem:IDENtify AT34410A or AT34411A** is set, the returned string has the following format (34465A or 34470A only):

Agilent Technologies,34410A,<Serial Number>,h.ff.ff-pp.pp-mm.mm-gg.gg-bb-fp
Agilent Technologies,34411A,<Serial Number>,h.ff.ff-pp.pp-mm.mm-gg.gg-bb-fp

Where:

h. - Hardware revision

ff.ff - Main firmware revision

pp.pp - Front panel firmware revision

mm.mm - Measurement board firmware revision

gg.gg - Measurement board FPGA revision

bb - Measurement board revision

fp - Front panel board revision

***LRN?**

Returns an ASCII string of all of the commands required to put the instrument into its current state.

Parameter	Typical Return
(none)	An ASCII string of SCPI commands, delimited with semicolons (";") between commands.
Return the learn string: *LRN?	

- Some parameters can be set with either [SENSe:]FREQUency or [SENSe:]PERiod versions of the same command. The *LRN string always returns the FREQUency version of the command, even if the parameter was set via the PERiod version. Similarly, parameters that can be set with RESistance or FRESistance versions of the same command always return the FRESistance version.

***OPC**

Sets "Operation Complete" (bit 0) in the Standard Event register at the completion of the current operation.

Parameter	Typical Return
(none)	(none)
Configure 100 DC voltage measurements and enable the generation of an SRQ when the measurements complete: *CLS *ESE 1 *SRE 32 CONF:VOLT:DC SAMP:COUN 100 INIT *OPC	

- Other commands may be executed before Operation Complete bit is set.
- The difference between *OPC and *OPC? is that *OPC sets a status bit when the operation completes, and *OPC? outputs "1" when the operation completes.

***OPC?**

Returns 1 to the output buffer after all pending commands complete. Other commands cannot be executed until this command completes.

Parameter	Typical Return
(none)	1
Configure 100 DC voltage measurements and return "1" when the measurements complete: CONF:VOLT:DC SAMP:COUN 100 INIT *OPC?	

- Use this command to synchronize your application with the instrument.
- The difference between *OPC and *OPC? is that *OPC sets a status bit when the operation completes, and *OPC? outputs "1" when the operation completes.

***OPT?**

Returns a string identifying any installed options.

Parameter	Typical Return
(none)	(see below)
Return the installed options: *OPT?	

- This query returns a string with the following format:

```
34460A: {GPB|0},{LAN|0},{SEC|0}
34461A: {GPB|0},{SEC|0}
34465A/70A: {GPB|0},{SEC|0},{DIG|0},{MEM|0}
```

A 0 is returned for options that are not installed. For example, a 34461A with only GPIB installed returns GPB,0. A 34460A with only GPB and SEC installed returns GPB,0,SEC.

- Options vary by model, as [shown here](#).

***PSC {0|1}**

***PSC?**

Power-On Status Clear. Enables (1) or disables (0) the clearing of certain enable registers at power on:

- Questionable Data Register (**STATus:QUEStionable:ENABle**)
- Standard Operation Register (**STATus:OPERation:ENABle**)
- Status Byte Condition Register (***SRE**)
- Standard Event Enable Register (***ESE**)

NOTE

The ***PSC** command does not affect the clearing of the condition or event registers, just the enable registers. For more information on the SCPI Status System, see **Status Sub-system Introduction**.

Parameter	Typical Return
{0 1}. Default: 1	0 or 1
Disable power-on clearing of affected registers: *PSC 0	

***RCL {0|1|2|3|4}**

***SAV {0|1|2|3|4}**

Stores the current instrument state to, or recalls the instrument state from, the state file *STATE_<n>.sta* in the root folder of the internal flash file system, where <n> is the number specified.

Parameter	Typical Return
{0 1 2 3 4}	(none)
Store the instrument state to the state file <i>STATE_1.sta</i> in the root folder of the internal flash file system: *SAV 1	

- ***SAV <n>** is equivalent to **MMEMory:STORe:STATe "INT:\STATE_<n>.sta"**.
- ***RCL <n>** is equivalent to **MMEMory:LOAD:STATe "INT:\STATE_<n>.sta"**.
- The state file created by ***SAV 0**, called *STATE_0.sta*, resides in the root folder of the internal flash file system. It is overwritten with the power-down state of the instrument when power is cycled.
- The instrument state enable settings are stored in nonvolatile memory. They do not change when power has been off, after a Factory Reset (***RST**) or after an Instrument Preset (**SYSTem:PRESet**).

***RST**

Resets instrument to **factory default state**. This is similar to **SYSTem:PRESet**. The difference is that *RST resets the instrument for SCPI operation, and SYSTem:PRESet resets the instrument for front panel operation. As a result, *RST turns the histogram and statistics off, and SYSTem:PRESet turns them on.

Parameter	Typical Return
(none)	(none)
Reset the instrument:	
*RST	

- Does not affect stored instrument states (see *SAV).

***SRE <enable_value>**

***SRE?**

Service Request Enable. Enables bits in the enable register for the **Status Byte Register** group. An enable register defines which bits in the event register will be reported to the Status Byte register group. You can write to or read from an enable register.

Parameter	Typical Return
Decimal sum of the bits in the register, default 0. For example, to enable bit 2 (value 4), bit 3 (value 8), and bit 7 (value 128), the decimal sum would be 140 (4 + 8 + 128). Default: 0.	+24
Enable bits 3 and 4 in the enable register:	
*SRE 24	

- To enable specific bits, specify the decimal value corresponding to the binary-weighted sum of the bits in the register. The selected bits are summarized in the "Master Summary" bit (bit 6) of the Status Byte Register. If any of the selected bits change from 0 to 1, the instrument generates a Service Request signal.
- ***CLS** clears the event register, but not the enable register. An event register is a read-only register that latches events from the condition register. While an event bit is set, subsequent events corresponding to that bit are ignored.
- ***PSC** (power-on status clear) determines whether Status Byte enable register is cleared at power on. For example, *PSC 0 preserves the enable register contents through power cycles.
- The Status Byte enable register is not cleared by ***RST**.

***STB?**

Read Status Byte Query. Queries the condition register for the **Status Byte Register** group and returns a decimal value equal to the binary-weighted sum of all bits set in the register.

A condition register continuously monitors the state of the instrument. Condition register bits are updated in real time; they are neither latched nor buffered.

Parameter	Typical Return
(none)	+40
Read condition register (with bits 3 and 5 set): *STB?	

- Similar to a Serial Poll, but processed like any other instrument command. This register is read-only; bits are not cleared when read.
- Returns same result as a Serial Poll, but the "Master Summary" bit (bit 6) is not cleared by ***STB?**.
- Power cycle and ***RST** clear all bits in the condition register.

***TRG**

Triggers the instrument if **TRIGger:SOURce BUS** is selected.

Parameter	Typical Return
(none)	(none)
Return five DC voltage measurements, using a software trigger to start the measurements: CONF:VOLT:DC SAMP:COUN 5 TRIG:SOUR BUS INIT *TRG FETCH? Typical Response: +1.00520000E+01, ... (5 measurements)	

- After setting the trigger source, you must send **INITiate** to place the DMM in the "wait-for-trigger" state. The ***TRG** command is not accepted unless the DMM is in the "wait-for-trigger" state.

***TST?**

Performs a basic self-test of the instrument and returns a pass/fail indication. The **TEST:ALL?** self-test is more comprehensive than the ***TST?** self-test.

Parameter	Typical Return
(none)	+0 (pass) or +1 (one or more tests failed)
Perform self-test: *TST?	

- The self-test takes just a few seconds to complete.
- If one or more tests fail, the query returns +1 and stores an error in the error queue. For a complete listing of the error messages related to self-test failures, see [Self-test Error Messages](#).
- Following the test, the instrument returns to the instrument state that existed before the self-test.

***WAI**

Configures the instrument's output buffer to wait for all pending operations to complete before executing any additional commands over the interface.

Parameter	Typical Return
(none)	(none)
Wait until all pending operations complete: *WAI	

- Configuration changes and measurements are considered pending operations. Therefore, ***WAI** causes these changes to occur and complete.

LXI Subsystem

This subsystem supports LAN eXtensions for Instrumentation (LXI) functionality.

Command Summary

LXI:IDENtify[:STATe]

LXI:MDNS:ENABle

LXI:MDNS:HNAME[:RESolved]?

LXI:MDNS:SNAME:DESired

LXI:MDNS:SNAME[:RESolved]?

LXI:RESet

LXI:REStart

LXI:IDENtify[:STATe] {ON|1|OFF|0}

LXI:IDENtify[:STATe]?

Shows or removes the LXI Web Identify indicator on the display.

Parameter	Typical Return
{ON 1 OFF 0}. Default: OFF.	0 (OFF) or 1 (ON)
Turn on the LXI Web Identify indicator:	
LXI:IDEN ON	

- The indicator helps you identify the device associated with the LAN address.
- Press the [Local] key or send *RST to turn off the indicator.

LXI:MDNS:ENABle {ON|1|OFF|0}

LXI:MDNS:ENABle?

Disables or enables the multicast Domain Name System (mDNS), which provides the capabilities of a DNS server for service discovery in a small network without a DNS server.

Parameter	Typical Return
{ON 1 OFF 0}. Default: ON.	0 (OFF) or 1 (ON)
Turn mDNS ON:	
LXI:MDSN:ENAB ON	

- This setting is non-volatile; it is not changed by power cycling, a Factory Reset (*RST), or an Instrument Preset (SYSTEM:PRESet).
- This parameter is set to its default value when the instrument is shipped from the factory and after SYSTEM:SECurity:IMMediate.

LXI:MDNS:HNAME[:RESolved]?

Returns the resolved (unique) mDNS hostname in the form K-*<model number>*-*<serial>*-N , where *<serial>* is the last 5 digits of the instrument's serial number. The N is an integer appended if necessary to make the name unique. The desired name may be truncated, if necessary, to make room for the appended integer.

Parameter	Typical Return
(none)	"K-34460A-yyyyy", where yyyyy is the last five digits of the serial number.
Return the resolved mDNS hostname:	
LXI:MDNS:HNAME:RESolved?	

LXI:MDNS:SNAME:DESired "<name>"

LXI:MDNS:SNAME:DESired?

Sets the desired mDNS service name.

Parameter	Typical Return
Quoted string of up to 63 characters. Default: "Keysight <i><model number></i> Digital Multimeter - <i><serial></i> " where <i><serial></i> is the last 5 digits of the instrument's serial number	"Keysight 34460A Digital Multimeter - 98765"
Set the mDNS service name:	
LXI:MDNS:SNAM:DES "LAB1-DMM"	

- This setting is non-volatile; it is not changed by power cycling, a Factory Reset (***RST**), or an Instrument Preset (**SYSTem:PRESet**).
- This parameter is set to its default value when the instrument is shipped from the factory and after **SYSTem:SECurity:IMMEDIATE**.

LXI:MDNS:SNAME[:RESolved]?

The resolved mDNS service name will be the desired service name (**LXI:MDNS:SNAME:DESired**), possibly with "*<N>*" appended. The N is an integer appended if necessary to make the name unique. The desired name may be truncated, if necessary, to make room for the appended integer.

Parameter	Typical Return
(none)	"Keysight 34461A Digital Multimeter - 00123"
Return resolved mDNS service name:	
LXI:MDNS:SNAME:RESolved?	

LXI:RESet

Resets LAN settings to a known operating state, beginning with DHCP, and clears the Web Interface password. If DHCP fails, it uses Auto-IP.

Parameter	Typical Return
(none)	(none)
Reset the LAN settings: LXI:RES	

- Depending on your network, the LAN interface may take several seconds to restart after this command is sent.
- If the LAN interface or specific LAN services (VXI-11, sockets, and so on) have been disabled by **SYSTem:COMMunicate:ENABle**, you must separately re-enable the interface or services and cycle instrument power for the LAN to be operational.

LXI:REStArt

Restarts the LAN with the current settings as specified by the **SYSTem:COMMunicate:LAN** commands.

Parameter	Typical Return
(none)	(none)
Restart the LAN interface: LXI:REST	

- Depending on your network, the LAN interface may take several seconds to restart after this command is sent.
- If the LAN interface or specific LAN services (VXI-11, sockets, and so on) have been disabled by **SYSTem:COMMunicate:ENABle**, you must separately re-enable the interface or services and cycle instrument power for the LAN to be operational.

MEASure Subsystem

The MEASure queries are the easiest way to program measurements because they always use default measurement parameters. You set the function, range, and resolution in one command, but you cannot change other parameters from their default values. The results are sent directly to the instrument's output buffer.

NOTE A MEASure query is functionally equivalent to sending CONFigure followed immediately by READ?. The difference is that CONFigure commands allow you to change parameters between the CONFigure and the READ?

Command Summary

MEASure:CAPacitance?

MEASure:CONTInuity?

MEASure:CURRent:{AC|DC}?

MEASure:DIODE?

MEASure:{FREQuency|PERiod}?

MEASure:{RESistance|FRESistance}?

MEASure:TEMPerature?

MEASure[:VOLTage]:{AC|DC}?

MEASure[:VOLTage][:DC]:RATio?

Default Settings for MEASure?

With the MEASure? queries, you can select the function, range and resolution in one command. All other parameters are set to their default values (below).

Measurement Parameter	Default Setting
AC Input Filter (bandwidth)	20 Hz (medium filter)
Autozero	OFF if resolution setting results in NPLC < 1 ON if resolution setting results in NPLC ≥ 1
Range	AUTO (including voltage range for frequency and period measurements)
Samples per Trigger	1 sample
Trigger Count	1 trigger
Trigger Delay	Automatic delay
Trigger Source	Immediate
Trigger Slope	NEGative
Math Functions	Disabled. Other parameters are unchanged.
Per-function Null State	Disabled

Using the MEASure? Query

The following example configures DC voltage measurements, internally triggers the instrument to take a measurement, and reads the measurement. The default range (autorange) and resolution (10 PLC) are used for the measurement.

```
MEAS:VOLT:DC?
```

Typical Response: +4.23450000E-03

The following example configures the instrument for 2-wire resistance measurements, triggers the instrument to take a measurement, and reads the measurement. The 1 k Ω range is selected with 0.1 Ω resolution.

```
MEAS:RES? 1000,0.1
```

Typical Response: +3.27150000E+02

MEASure:CAPacitance? [{<range>|AUTO|MIN|MAX|DEF} [, {<resolution>|MIN|MAX|DEF}]]

Sets all measurement parameters and trigger parameters to their **default values** for capacitance measurements and immediately triggers a measurement. The results are sent directly to the instrument's output buffer.

Parameter	Typical Return
<range>: {1 nF 10 nF 100 nF 1 μF 10 μF 100 μF}. Default: AUTO.	(none)
<resolution>: optional and ignored; fixed at 4½ digits.	
Configure capacitance measurements. Then make and read one measurement: MEAS:CAP? Typical Response: +3.01534021E-10	

- You can let autoranging select the measurement range, or you can manually select a fixed range. Autoranging conveniently selects the range for each measurement based on the input signal. For fastest measurements, use manual ranging (autoranging may require additional time for range selection).
- Autoranging (AUTO or DEFault), will generate an error if you specify a <resolution> because the instrument cannot accurately resolve the integration time (especially if the input continuously changes). If your application requires autoranging, specify DEFault for the <resolution> or omit the <resolution> altogether.
- Autoranging goes down a range at less than 10% of range and up a range at greater than 120% of range. For capacitance measurements only, when autorange is off, the instrument does not report an overload for readings greater than 120% of range. Overload only occurs when the algorithm times out because the applied capacitance is too large for the algorithm to measure. If you apply a DC voltage or a short to the input terminals in capacitance measurement mode, the instrument reports an overload.
- If the input signal is greater than can be measured on the specified manual range, the instrument displays the word *Overload* on front panel and returns "9.9E37" from the remote interface.

MEASure:CONTInuity?

Sets all measurement parameters and trigger parameters to their **default values** for continuity test and immediately triggers a measurement. The results are sent directly to the instrument's output buffer.

Parameter	Typical Return
(none)	(none)
Configure the instrument for continuity measurements. Then make and read one measurement:	
MEAS:CONT?	
Typical Response: +1.32130000E-02	

- The range and resolution are fixed at 1 kΩ for continuity tests (a 2-wire resistance measurement).
- The instrument beeps (if the beeper is enabled) for each measurement less than or equal to the continuity threshold ($\leq 10 \Omega$), and the actual resistance measurement appears on the display.
- From 10 Ω to 1.2 kΩ, the instrument displays the actual resistance measurement with no beep. Above 1.2 kΩ, the instrument displays "OPEN" with no beep.
- The **FETCh?**, **READ?**, and **MEASure:CONTInuity?** queries return the measured resistance, regardless of its value.

MEASure:CURRent:{AC|DC}? [{<range>|AUTO|MIN|MAX|DEF} [, {<resolution>|MIN|MAX|DEF}]]

Sets all measurement parameters and trigger parameters to their **default values** for AC or DC current measurements and immediately triggers a measurement. The results are sent directly to the instrument's output buffer.

Parameter	Typical Return
<range>: {100 μ A 1 mA 10 mA 100 mA 1 A 3 A 10 A}. Default: AUTO (autorange).	(none)
<resolution> (AC): optional and ignored; fixed at 6½ digits. <resolution> (DC): See Resolution Table or Range, Resolution and NPLC . The default is equivalent to 10 PLC. Specify <resolution> in the measurement's units (V, A, Hz, Ω , and so on).	
Configure AC current measurements using the 1 A range. Then make and read one measurement: MEAS:CURR:AC? 1 Typical Response: +8.54430000E-01	

- You can let autoranging select the measurement range, or you can manually select a fixed range. Autoranging conveniently selects the range for each measurement based on the input signal. For fastest measurements, use manual ranging (autoranging may require additional time for range selection).
- Autoranging (AUTO or DEFault), will generate an error if you specify a <resolution> because the instrument cannot accurately resolve the integration time (especially if the input continuously changes). If your application requires autoranging, specify DEFault for the <resolution> or omit the <resolution> altogether.
- Autoranging goes down a range at less than 10% of range and up a range at greater than 120% of range.
- If the input signal is greater than can be measured on the specified manual range, the instrument displays the word *Overload* on front panel and returns "9.9E37" from the remote interface.

MEASure:DIODe?

Sets all measurement parameters and trigger parameters to their **default values** for diode test measurements and immediately triggers a measurement. The results are sent directly to the instrument's output buffer.

Parameter	Typical Return
(none)	(none)
Configure, make, and read a default diode measurement:	
MEAS:DIOD?	
Typical Response: +1.32130000E-01	

- The range and resolution are *fixed* for diode tests: the range is 1 VDC (with a 1 mA current source output).
- The voltage is displayed on the front panel if it is between 0 and 5.05 V. The instrument beeps when the signal transitions into the range between 0.3 and 0.8 V (unless beeper is disabled). If the signal exceeds 5.05 V, the front panel shows "OPEN", and the value returned from SCPI is 9.9E37.
- The **FETCh?**, **READ?**, and **MEASure:DIODe?** queries return the measured voltage, regardless of its value.

MEASure:{FREQUENCY|PERiod}? [{<range>|MIN|MAX|DEF} [, {<resolution>|MIN|MAX|DEF}]]

Sets all measurement parameters and trigger parameters to their **default values** for frequency or period measurements and immediately triggers a measurement. The results are sent directly to the instrument's output buffer.

Parameter	Typical Return
<range>: 3 Hz to 300 kHz. Default: 20 Hz. for FREQUENCY <range>: 3.33 μs to 333.33 ms. Default: 50 ms (PERiod).	(none)
<resolution>: See table below. Specify <resolution> in the measurement's units (V, A, Hz, Ω, and so on).	
Configure frequency measurements using the default aperture. Then make and read one measurement: MEAS:FREQ? Typical Response: +1.32130000E+03	

- The 1 ms aperture applies only to the 34465A and 34470A.
- The frequency or period <range> parameter is required only to specify the measurement resolution parameter. It is not necessary to send a new command for each new frequency or period to be measured. The <range> and <resolution> parameters affect the aperture (gate time) as follows:

Resolution (34460A/61A)	Resolution (34465A/70A)	Aperture
Not Applicable	100 ppm × <range> (MAXimum)	1 ms
100 ppm × <range> (MAXimum)	10 ppm × <range> (DEFault)	10 ms
10 ppm × <range> (DEFault)	1 ppm × <range>	100 ms
1 ppm × <range> (MINimum)	0.1 ppm × <range> (MINimum)	1 s

- The input signal for frequency or period measurements has an AC voltage component. By default, this command uses autorange to select the voltage range.
- With no signal applied, 0 is returned.

MEASure:{RESistance|FRESistance}? [{<range>|AUTO|MIN|MAX|DEF} [, {<resolution>|MIN|MAX|DEF}]]

Sets all measurement and trigger parameters to their **default values** for 4-wire resistance (FRESistance) or 2-wire (RESistance) measurements, and immediately triggers a measurement. The results are sent directly to the instrument's output buffer.

Parameter	Typical Return
<range>: 100 Ω, 1 kΩ, 10 kΩ, 100 kΩ, 1 MΩ, 10 MΩ, 100 MΩ, 1 GΩ, AUTO, or DEFault. Default: AUTO.	(none)
<resolution>: See Resolution Table or Range, Resolution and NPLC . The default is equivalent to 10 PLC. Specify <resolution> in the measurement's units (V, A, Hz, Ω, and so on).	
Configure 4-wire resistance measurements using the 100 Ω range with default resolution. Then make and read one measurement: MEAS:FRES? 100 Typical Response: +8.54530000E+01	

- The 1 GΩ range applies only to the 34465A and 34470A.
- You can let autoranging select the measurement range, or you can manually select a fixed range. Autoranging conveniently selects the range for each measurement based on the input signal. For fastest measurements, use manual ranging (autoranging may require additional time for range selection).
- Autoranging (AUTO or DEFault), will generate an error if you specify a <resolution> because the instrument cannot accurately resolve the integration time (especially if the input continuously changes). If your application requires autoranging, specify DEFault for the <resolution> or omit the <resolution> altogether.
- Autoranging goes down a range at less than 10% of range and up a range at greater than 120% of range.
- If the input signal is greater than can be measured on the specified manual range, the instrument displays the word *Overload* on front panel and returns "9.9E37" from the remote interface.

MEASure:TEMPerature? [{FRTD|RTD|FTHermistor|THERmistor|TCouple|DEFault} [, {<type>|DEFault} [,1 [, {<resolution>|MIN|MAX|DEF}]]]]

Sets all measurement parameters and trigger parameters to their **default values** for temperature measurements and immediately triggers a measurement. The results are sent directly to the instrument's output buffer.

Parameter	Typical Return
<probe_type>: {FRTD RTD FTHermistor THERmistor TCouple}. Default: FRTD.	(none)
<type>: 85 (only possible value for RTD/FRTD), 5000 (only possible value for THERmistor/FTHermistor), or E, J, K, N, R, T (TCouple).	
<resolution>: See Resolution Table or Range, Resolution and NPLC . The default is equivalent to 10 PLC.	
Configure a 4-wire RTD measurement with default resolution. Then make and read one measurement: MEAS:TEMP? FRTD,85 Typical Response: +2.12320000E+01	

- Thermocouple measurements (TC) apply only to the 34465A and 34470A.
- For temperature measurements, the instrument internally selects the range; you cannot select the range to be used. The range ("1" is the only allowed value) is used only in conjunction with resolution to determine NPLC.
- The <resolution> parameter only determines the integration time; it does not specify the resolution of the temperature measurement. This parameter is optional; however, if you specify <resolution>, you must also specify "1" as the implied range parameter. For example: CONF:TEMP RTD,85,1,0.000001 selects the 10 PLC integration time on the 34461A.
- To change temperature units, use **UNIT:TEMPerature**.
- For RTD and thermistor measurements, the instrument autoranges to the correct range for the transducer resistance measurement. For thermocouple measurements, the 100 mV range is selected.
- For thermocouple measurements, the internal reference is selected. See **SENSe:TEMPerature:TCouple:RJUNction:TYPE**.
- If the input signal is greater than can be measured on the specified manual range, the instrument displays the word *Overload* on front panel and returns "9.9E37" from the remote interface.

MEASure[:VOLTage]:{AC|DC}? [{<range>|AUTO|MIN|MAX|DEF} [, {<resolution>|MIN|MAX|DEF}]]

Sets all measurement parameters and trigger parameters to their **default values** for AC or DC voltage measurements and immediately triggers a measurement. The results are sent directly to the instrument's output buffer.

WARNING The maximum range parameter (MAX) is 1000 V. However, the SAFETY LIMIT on the front and rear HI/LO input terminals is 750 VAC (rms). The rms voltage is waveform dependent. A sine wave is limited to 750 VAC (rms), but a 1000 Vpk square wave is safe. Connection to AC mains power is further limited to CAT II (300 V). See **Safety and Regulatory Information** for more information on the safety features and the safe operation of this instrument.

Parameter	Typical Return
<range>: 100 mV, 1 V, 10 V, 100 V, 1000 V, AUTO (default) or DEFault	(none)
<resolution> (AC): optional and ignored; fixed at 6½ digits.	
<resolution> (DC): See Resolution Table or Range, Resolution and NPLC . The default is equivalent to 10 PLC. Specify <resolution> in the measurement's units (V, A, Hz, Ω, and so on).	
Configure DC voltage measurements using the 10 V range with 1 mV resolution. Then make and read one measurement: MEAS:VOLT:DC? 10,0.001 Typical Response: +8.54530000E+01	

- You can let autoranging select the measurement range, or you can manually select a fixed range. Autoranging conveniently selects the range for each measurement based on the input signal. For fastest measurements, use manual ranging (autoranging may require additional time for range selection).
- Autoranging (AUTO or DEFault), will generate an error if you specify a <resolution> because the instrument cannot accurately resolve the integration time (especially if the input continuously changes). If your application requires autoranging, specify DEFault for the <resolution> or omit the <resolution> altogether.
- Autoranging goes down a range at less than 10% of range and up a range at greater than 120% of range.
- If the input signal is greater than can be measured on the specified manual range, the instrument displays the word *Overload* on front panel and returns "9.9E37" from the remote interface.

MEASure[:VOLTage][:DC]:RATio? [{<range>|AUTO|MIN|MAX|DEF} [, {<resolution>|MIN|MAX|DEF}]]

Sets all measurement parameters and trigger parameters to their **default values** for DC voltage ratio measurements and immediately triggers a measurement. The results are sent directly to the instrument's output buffer.

To calculate a ratio, the instrument measures a DC reference voltage applied to the *Sense* terminal and the DC signal voltage applied to the *Input* terminals. It then uses the formula:

$$\text{Ratio} = \text{DC signal voltage} / \text{DC reference voltage}$$

Parameter	Typical Return
<range>: 100 mV, 1 V, 10 V, 100 V, 1000 V, AUTO (default) or DEFault	(none)
<resolution>: See Resolution Table or Range, Resolution and NPLC . The default is equivalent to 10 PLC.	
Configure DC voltage ratio measurements using the 100 V range with 1 mV resolution. Then make and read one measurement: MEAS:VOLT:DC:RAT? 100,0.001 Typical Response: +4.27150000E+00	

- The *Sense* terminals have a maximum measurable input of ±12 VDC. Autoranging is automatically selected for reference voltage measurements on the *Sense* terminals.
- The *Input LO* and *Sense LO* terminals must have a common reference and cannot have a voltage difference greater than ±2 V.
- The specified measurement range applies only to the signal connected to the *Input* terminals. The signal on the *Input* terminals can be any DC voltage up to 1,000 V.
- For the *Input* terminals, you can allow the instrument to select the measurement range by autoranging or you can select a fixed range using *manual ranging*. Autoranging decides which range to use for each measurement based on the input signal. For faster measurements, use manual ranging on each measurement (additional time is required for autoranging to select a range).
- Autoranging (AUTO or DEFault), will generate an error if you specify a <resolution> because the instrument cannot accurately resolve the integration time (especially if the input continuously changes). If your application requires autoranging, specify DEFault for the <resolution> or omit the <resolution> altogether.
- Autoranging goes down a range at less than 10% of range and up a range at greater than 120% of range.
- If the input signal is greater than can be measured on the specified manual range, the instrument displays the word *Overload* on front panel and returns "9.9E37" from the remote interface.

MMEMory Subsystem - General Purpose File Management

The MMEMory subsystem's general purpose file management commands are listed below. The MMEMory subsystem also includes two other types of commands:

STATe and PREFerence File Management

Data Transfer

Commands and Queries

MMEMory:CATalog[:ALL]?

MMEMory:CDIRectory

MMEMory:COPI

MMEMory:DELeTe

MMEMory:MDIRectory

MMEMory:MOVE

MMEMory:RDIRectory

Folder and file formats

Many MMEMory commands refer to folders and files. These have specific structures, described below.

Format for a <folder>

- The format for <folder> is "[[<drive>:]<path>]", where <drive> can be INTernal or USB, and <path> is a folder path, and <filespec> specifies a subset of files.
- INTernal specifies the internal flash file system. USB specifies a front panel USB storage device.
- If <drive> is specified, <path> is interpreted as an absolute folder path. Absolute paths begin with "\" or "/" and start at the root folder of <drive>.
- If <drive> is omitted, <path> is relative to the folder specified by **MMEMory:CDIRectory**. Relative paths must NOT begin with \ or /.
- Folder and file names cannot contain the following characters: \ / : * ? " < > |
- The <folder> parameter cannot exceed 240 characters.
- The specified folder must exist and cannot be marked as hidden or system. The exception is **MMEMory:MDIRectory**, which creates a folder. For MMEMory:MDIRectory, all folder levels above the new one must exist.

Format for a <file>

- The format for a file name is "[[<drive>:]<path><file_name>]", where <drive> can be INTernal or USB, and <path> is a folder path.
- INTernal specifies the internal flash file system. USB specifies a front panel USB storage device.
- If <drive> is specified, <path> is interpreted as an absolute folder path. Absolute paths begin with "\" or "/" and start at the root folder of <drive>.
- If <drive> is omitted, <path> is relative to the folder specified by **MMEMory:CDIRectory**. Relative paths must NOT begin with \ or /.
- Folder and file names cannot contain the following characters: \ / : * ? " < > |
- The combination of folder and file name cannot exceed 240 characters.

MMEMory:CATalog[:ALL]? [<folder>[<filespec>]]

Returns a list of files in the specified folder.

Parameter	Typical Return
Any valid folder name ; defaults to folder selected by MMEMory:CDIRectory	+1000000000,+327168572, "command.exe,,375808", "MyDCVMeas.sta,STAT,8192",MyData.csv,ASC,11265"
List all files in the folder MyData on the front panel USB storage device: MMEM:CAT? "USB:\MyData"	
List all state files in the root directory of internal memory: MMEM:CAT? "INT:*.sta"	

- If <filespec> is omitted or is *.* , the command or query acts on all files. You can also use the * as a generic wildcard: *.sta, abc*.* , and so on.
- The catalog takes the following form:

<mem_used>,<mem_free>{"<file_listing>"}

The instrument returns two numbers and a string for each file in the folder. The first number is the number of bytes used on the drive. The second indicates the number of bytes available. Each <file_listing> is in the format "<file_name>,<file_type>,<file_size>" (including the quotation marks), where <file_name> is the name of the file including file extension, if any; <file_type> is either STAT for STATE (.sta) files, ASC for DATA (.csv) files, PREF for PREFERenCe (.prf) files, FOLD for folders, or null for all other file extensions; <file_size> is the file size in bytes.

- If no files exist, only <mem_used>,<mem_free> is returned.
- Because the instrument uses a small amount of space in the flash file system for internal use, the <mem_used> value is never zero.

MMEMory:CDIRectory <folder>

MMEMory:CDIRectory?

MMEMory:MDIRectory <folder>

MMEMory:RDIRectory <folder>

MMEMory:CDIRectory selects the default folder for MMEMory subsystem commands. This folder must exist and is used when folder or file names do not include a drive and folder name. They query returns the current default folder.

MMEMory:MDIRectory makes a new directory (folder) on the mass storage medium.

MMEMory:RDIRectory removes a directory (folder) on the mass storage medium.

Parameter	Typical Return
Any directory name, including the mass storage unit specifier. Default INT: \.	"INT:\BACKUP"
Make and remove a new directory named "test" on the internal mass memory system: MMEM:MDIR "test" MMEM:RDIR "test" Select the \BACKUP folder on the internal flash file system as the default folder: MMEM:CDIR "INT:\BACKUP" Return the default folder for MMEMory subsystem commands: MMEM:CDIR?	

- This parameter is set to its default value after a Factory Reset (***RST**) or Instrument Preset (**SYSTem:PRESet**).
- You can only remove an empty folder. Otherwise, the instrument generates a "Directory not empty" error.

MMEMory:COPY <file1>,<file2>

Copies <file1> to <file2>. Each file name must include the file extension.

Parameter	Typical Return
Any valid file name (both files)	(none)
Copy state file from the root directory to the folder "Backup" on the internal flash file system: MMEM:COPY "INT:\MyVoltMeas.sta","INT:\Backup"	

- The source file and folder must exist and cannot be marked as hidden or system.
- The destination folder must exist and cannot be marked as hidden or system.
- If the destination file exists, it will be overwritten, unless marked as hidden or system.
- To copy a file to a file of the same name in a different folder, specify just the <drive> and/or <path> for <destination>.

MMEMory:DELeTe {<file>|<filespec>}

Deletes a file. To delete a folder, use MMEMory:RDIRectory.

Parameter	Typical Return
Any valid file name , including file extension, or a <filespec>, as described below.	(none)
Delete a file from the root directory of the internal flash file system: MMEM:DEL "INT:\MySetup.sta"	

- A <filespec> may include the * as a wildcard character: *.bmp, *.sta, abc*.*, and so on.
- The specified folder must exist and cannot be marked as hidden or system.
- **SYSTEM:SECurity:IMMediate** deletes and sanitizes all files.

MMEMory:MOVE <file1>,<file2>

Moves and/or renames <file1> to <file2>. Each file name must include the file extension.

Parameter	Typical Return
Any valid file name (both files)	(none)
Move the specified state file from the currently selected default directory to the folder "Backup" on the internal flash file system: MMEM:MOVE "MyVoltMeas.sta","INT:\Backup"	

- To rename a file, specify the same folder for <file1> and <file2>.
- To move a file to a file of the same name in a different folder, you can specify just the <drive>:<path> for <file2>.

MMEMory Subsystem - STATe and PREFerence Files

These MMEMory subsystem commands save and load instrument states (state files) and preferred settings for non-volatile parameters (preference files). In general, state files store volatile settings associated with measurements. Preferences are non-volatile parameters associated with the instrument, but not any specific measurement. The following table summarizes what information is in each file.

State File	Preference File
<p>State Files for the 34460A/61A/65A/70A have this information:</p> <p>Active measurement function</p> <p>Ranges</p> <p>Integration time/resolution (NPLC)</p> <p>Auto range</p> <p>Auto zero</p> <p>Auto impedance (Input Z)</p> <p>AC bandwidth</p> <p>Trigger and sample settings</p> <p>Math settings (enables, null value(s), limits, ...)</p> <p>Data threshold for status bit</p> <p>VM Comp slope (Voltmeter Complete)</p> <p>Temperature units</p> <p>Default file system directory</p> <p>Display selection and settings (numeric, meter, histogram, trend chart, ...)</p> <p>Numeric front panel digit masking</p> <p>DBM reference resistance</p> <p>State Files for the 34465A/70A have this additional information:</p> <p>Binary/ASCII data format and byte order</p> <p>Trend chart and histogram display settings</p> <p>Data Log and Digitize mode settings</p> <p>Temperature probe settings</p> <p>Thermocouple reference junction offset adjustment</p>	<p>Preference Files for the 34460A/61A/65A/70A have this information:</p> <p>I/O enables, addresses, settings; mDNS settings</p> <p>Display brightness</p> <p>Screen saver enable, brightness</p> <p>Numeric separator (comma, space, none) and decimal point symbol</p> <p>Beeper and key click enable</p> <p>Help language</p> <p>Power-on status clear enable, status enables, transition filters</p> <p>Power-on state (*RST, user-defined, last)</p> <p>SCPI ID (string returned by *IDN)</p> <p>Power-on message text</p> <p>Color Scheme (A/B)</p> <p>Label enable, text</p> <p>Preference Files for the 34465A/70A have this additional information:</p> <p>Data Log mode file format settings</p> <p>Thermocouple reference junction offset adjustment</p>

The MMEMory subsystem also includes two other types of commands:

[General Purpose File Management](#)

[Data Transfer](#)

Command Summary

MMEMory:LOAD:PREFerences

MMEMory:STORe:PREFerences

MMEMory:LOAD:STATe

MMEMory:STORe:STATe

MMEMory:STATe:RECall:AUTO

MMEMory:STATe:RECall:SElect

MMEMory:STATe:VALid?

Folder and file formats

Many MMEMory commands refer to folders and files. These have specific structures, described below.

Format for a <folder>

- The format for <folder> is "[[<drive>:]<path>]", where <drive> can be INTernal or USB, and <path> is a folder path, and <filespec> specifies a subset of files.
- INTernal specifies the internal flash file system. USB specifies a front panel USB storage device.
- If <drive> is specified, <path> is interpreted as an absolute folder path. Absolute paths begin with "\" or "/" and start at the root folder of <drive>.
- If <drive> is omitted, <path> is relative to the folder specified by MMEMory:CDIRectory. Relative paths must NOT begin with \ or /.
- Folder and file names cannot contain the following characters: \ / : * ? " < > |
- The <folder> parameter cannot exceed 240 characters.
- The specified folder must exist and cannot be marked as hidden or system. The exception is MMEMory:MDIRectory, which creates a folder. For MMEMory:MDIRectory, all folder levels above the new one must exist.

Format for a <file>

- The format for a file name is "[[<drive>:]<path><file_name>]", where <drive> can be INTernal or USB, and <path> is a folder path.
- INTernal specifies the internal flash file system. USB specifies a front panel USB storage device.
- If <drive> is specified, <path> is interpreted as an absolute folder path. Absolute paths begin with "\" or "/" and start at the root folder of <drive>.
- If <drive> is omitted, <path> is relative to the folder specified by MMEMory:CDIRectory. Relative paths must NOT begin with \ or /.
- Folder and file names cannot contain the following characters: \ / : * ? " < > |
- The combination of folder and file name cannot exceed 240 characters.

Mass Memory (MMEMory) and State Storage

States saved by the front panel can be accessed from remote, and vice versa. For example, configure the instrument as desired and insert a USB drive into the front panel. Then enter the following commands. If you do not have a USB drive change "USB:\\" to "INT:\\" to use the instrument's internal flash drive instead.

```
MMEMory:CDIRectory "USB:\\"
MMEMory:MDIRectory "States"
MMEMory:STORe:STATE "USB:\States\State1"
```

To return to this state at any time:

```
MMEMory:LOAD:STATE "USB:\States\State1"
```

You can also recall a state file from the front panel by pressing [Utility] > Store/Recall.

MMEMory:LOAD:PREFerences <file>

MMEMory:STORe:PREFerences <file>

LOAD: Reboots the instrument and loads the nonvolatile I/O settings and user preferences from a file. The specified file cannot be empty or marked as hidden or system.

STORE: Stores nonvolatile I/O settings and user preferences to a file. If the destination file exists, it will be overwritten, unless marked as hidden or system.

CAUTION When loading a preferences file that specifies a static IP address, be careful that this does not result in two instruments with the same IP address on your LAN. This could cause LAN configuration errors on both instruments.

Parameter	Typical Return
Any valid file name The .prf file extension is optional. If you do not include this extension, the instrument firmware will automatically append it.	(none)
Stores the current nonvolatile I/O settings and user preferences into the specified file: MMEM:STOR:PREF "INT:\MyPreferences" Load nonvolatile I/O settings and user preferences from the specified file: MMEM:LOAD:PREF "INT:\MyPreferences"	

- See the [State File/Preferences File table](#) for a listing of the information contained in each file.
- The specified folder must exist and cannot be marked as hidden or system.

MMEMory:LOAD:STATe <filename>
MMEMory:STORe:STATe <filename>

Loads an instrument state from a state file or saves the current instrument state to a state file. The file name optionally includes the folder name and the .sta file extension. If you do not include this extension, the instrument firmware will automatically append it.

Parameter	Typical Return
Any valid file name	(none)
Store the current instrument state to the specified state file in the root directory of the internal flash file system: MMEM:STOR:STAT "INT:\MySetup"	
Load the instrument state from MySetup.sta saved by the previous command: MMEM:LOAD:STAT "INT:\MySetup.sta"	

- See the [State File/Preferences File table](#) for a listing of the information contained in each file.
- The specified folder must exist and cannot be marked as hidden or system.
- The specified file cannot be empty or marked as hidden or system.
- The state file created by *SAV 0, called STATE_0.sta, resides in the root folder of the internal flash file system. It is overwritten with the power-down state of the instrument when power is cycled.

MMEMory:STATe:RECall:AUTO {ON|1|OFF|0}
MMEMory:STATe:RECall:AUTO?

Disables or enables the automatic recall of a specific stored instrument state at power-on. Specify ON to automatically recall the power-down state file (STATE_0 in the root folder of the internal flash file system) or a user-specified state file (MMEMory:STATe:RECall:SElect). Select "OFF" to issue a Factory Reset (*RST) at power-on.

Parameter	Typical Return
{ON 1 OFF 0}. Default: ON.	0 (OFF) or 1 (ON)
Select the power-down state to be used at power-on. MMEM:STAT:REC:SEL "INT:\STATE_0" MMEM:STAT:REC:AUTO ON	
Save the current state into a file in the root directory of the internal flash file system and load it at power-on: MMEM:STOR:STAT "INT:\MyVoltMeas" MMEM:STAT:REC:SEL "INT:\MyVoltMeas" MMEM:STAT:REC:AUTO ON	

- When shipped from the factory, the instrument is configured to automatically recall the power-down state file when power is restored.
- This setting is non-volatile; it is not changed by power cycling, a Factory Reset (*RST), or an Instrument Preset (SYSTEM:PRESet).

MMEMory:STATe:RECall:SElect <file>
MMEMory:STATe:RECall:SElect?

Selects which instrument state to use at power-on if the automatic recall mode is enabled (**MMEMory:STATe:RECall:AUTO ON**). If the automatic recall mode is disabled (**MMEMory:STATe:RECall:AUTO OFF**), a Factory Reset (***RST**) is issued at power-on.

Parameter	Typical Return
Any valid file name	"INT:\MyVoltMeas"
Select the power-down state to be used at power-on. MMEM:STAT:REC:SEL "INT:\STATE_0" MMEM:STAT:REC:AUTO ON Save the current state into a file in the root directory of the internal flash file system and load it at power-on: MMEM:STOR:STAT "INT:\MyVoltMeas" MMEM:STAT:REC:SEL "INT:\MyVoltMeas" MMEM:STAT:REC:AUTO ON	

- The specified folder must exist and cannot be marked as hidden or system.
- The state file created by *SAV 0, called STATE_0.sta, resides in the root folder of the internal flash file system. It is overwritten with the power-down state of the instrument when power is cycled.
- When shipped from the factory, the instrument is configured to automatically recall the power-down state file when power is restored.
- This setting is non-volatile; it is not changed by power cycling, a Factory Reset (***RST**), or an Instrument Preset (**SYSTem:PRESet**).

MMEMory:STATe:VALid? <file>

Returns 1 if the specified state file exists and contains a valid state file. Returns 0 otherwise.

Parameter	Typical Return
Any valid file name	1
Return the status of MyState.sta in the root folder of the internal flash file system. MMEM:STAT:VAL? "INT:\MyState.sta"	

- The specified folder must exist and cannot be marked as hidden or system.
- The specified file cannot be empty or marked as hidden or system.
- Use this query before sending ***RCL** or **MMEMory:LOAD:STATe** to determine whether a state has been stored in the file.

MMEMory Subsystem - Data Transfer Commands

These commands transfer files into and out of the instrument's mass memory.

The MMEMory subsystem also includes two other types of commands:

General Purpose File Management

STATe and PREFerence File Management

Command Summary

MMEMory:DOWNload:DATA

MMEMory:DOWNload:FNAME

MMEMory:FORMat:READing:CSEPARATOR

MMEMory:FORMat:READing:INFORMATION

MMEMory:FORMat:READing:RLIMIT

MMEMory:STORe:DATA

MMEMory:UPLoad?

Folder and file formats

Many MMEMory commands refer to folders and files. These have specific structures, described below.

Format for a <folder>

- The format for <folder> is "[[<drive>:]<path>]", where <drive> can be INTernal or USB, and <path> is a folder path, and <filespec> specifies a subset of files.
- INTernal specifies the internal flash file system. USB specifies a front panel USB storage device.
- If <drive> is specified, <path> is interpreted as an absolute folder path. Absolute paths begin with "\" or "/" and start at the root folder of <drive>.
- If <drive> is omitted, <path> is relative to the folder specified by **MMEMory:CDIRectory**. Relative paths must NOT begin with \ or /.
- Folder and file names cannot contain the following characters: \ / : * ? " < > |
- The <folder> parameter cannot exceed 240 characters.
- The specified folder must exist and cannot be marked as hidden or system. The exception is **MMEMory:MDIRectory**, which creates a folder. For MMEMory:MDIRectory, all folder levels above the new one must exist.

Format for a <file>

- The format for a file name is "[[<drive>:]<path><file_name>]", where <drive> can be INTernal or USB, and <path> is a folder path.
- INTernal specifies the internal flash file system. USB specifies a front panel USB storage device.
- If <drive> is specified, <path> is interpreted as an absolute folder path. Absolute paths begin with "\" or "/" and start at the root folder of <drive>.
- If <drive> is omitted, <path> is relative to the folder specified by **MMEMory:CDIRectory**. Relative paths must NOT begin with \ or /.
- Folder and file names cannot contain the following characters: \ / : * ? " < > |
- The combination of folder and file name cannot exceed 240 characters.

MMEMory:DOWNload:DATA <binary_block>

Downloads data from the host computer to a file whose name has been specified by **MMEMory:DOWNload:FNAME**.

The data in <binary_block> is written to the selected file.

NOTE Any data previously stored in the file is lost when you execute this command.

Parameter	Typical Return
Any IEEE-488.2 definite- or indefinite-length block	(none)
Write "Hello" to the file "\Myfile" on internal storage.	
MMEM:DOWN:FNAME "INT:\Myfile"	
MMEM:DOWN:DATA #15Hello	

MMEMory:DOWNload:FNAME <filename>

MMEMory:DOWNload:FNAME?

Creates or opens the specified filename prior to writing data to that file with **MMEMory:DOWNload:DATA**.

Parameter	Typical Return
Any valid file name	(none)
Write "Hello" to the file "\Myfile" on internal storage.	
MMEM:DOWN:FNAME "INT:\Myfile"	
MMEM:DOWN:DATA #15Hello	

- The specified folder must exist and cannot be marked as hidden or system.
- If the destination file exists, it will be overwritten, unless marked as hidden or system.
- The file is created if it does not already exist.

MMEMory:FORMat:READing:CSEparator {COMMa|SEMicolon|TAB}

MMEMory:FORMat:READing:CSEparator?

Specifies the character used to separate the columns in stored data.

Parameter	Typical Return
{COMMa SEMicolon TAB}. Default: COMMa.	TAB, COMM or SEM
Specify tabs as the column separator:	
MMEMory:FORMat:READing:CSEparator TAB	

- Applies only to the 34465A and 34470A.
- Affects the format for the .csv file created by the **MMEMory:STORe:DATA** command, or by the data logging/digitizing features in the 34465A/34470A.

MMEMory:FORMat:READing:INFormation {OFF|ON}

MMEMory:FORMat:READing:INFormation?

Disables/enables header information and reading numbers in stored data.

Parameter	Typical Return
{OFF ON}. Default OFF.	OFF or ON
Enable the format for the .csv file: MMEM:FORMat:READing:INFormation ON	

- Applies only to the 34465A and 34470A.
- The format for the .csv file (**MMEMory:STORe:DATA**), or by the data logging/digitizing features in the 34465A/34470A, are affected as follows:
OFF = one reading per row, no other header or reading information.
ON = enables a file header and reading numbers. The file header contains the start date and start time of the first reading and, if the sample source is timer (SAMPLE:SOURce:TIMer), the sample interval. Each data row includes a reading number and the reading.
- Affects the .dat (binary) file created by **MMEMory:STORe:DATA** as follows:
OFF = one reading per row, no other header or per reading information.
ON = one time stamp row consisting of eight 16-bit integers for: year, month, day of week, day, hour, minute, and milliseconds. 32-bit integer reading number and 64-bit IEEE-754 reading.

MMEMory:FORMat:READing:RLIMit {OFF|ON}

MMEMory:FORMat:READing:RLIMit?

When enabled, limits the maximum number rows per stored .csv data file to one million, including any header row, if enabled.

Parameter	Typical Return
{OFF ON}. Default ON.	OFF or ON
Disable row limits for the .csv file: MMEM:FORM:READ:RLIMit OFF	

- Applies only to the 34465A and 34470A.
- Affects the format for the .csv file created by the **MMEMory:STORe:DATA** command, or by the data logging/digitizing features in the 34465A/34470A.
- This feature enables you to accommodate common spreadsheet, database and data analysis programs that have limitations of 1 million rows per file.
- ON - Readings are stored in files named dat00001.csv, dat00002.csv, dat00003.csv ...
- OFF - Readings are is stored in a single file named dat00001.csv. The file size is limited to $2^{32} = 4.294967296$ GBytes (the maximum allowed by the FAT32 file system).

MMEMory:STORe:DATA RDG_STORE, <file>

Stores all measurements in reading memory to the specified data file. The file name optionally includes the folder name and the .csv or .dat file extension.

Parameter	Typical Return
Any valid file name	(none)
Store all measurements in reading memory to MyVoltMeas.csv in the root folder of the internal flash file system.	
MMEM:STOR:DATA RDG_STORE,"INT:\MyVoltMeas"	

- If a .csv file extension is specified, or if no file extension is specified, the data is stored in ASCII format. If the .dat file extension is specified, the data is stored in binary format.
- The format of the file is affected by **MMEMory:FORMat:READing:CSEParator**, **MMEMory:FORMat:READing:INFormation**, and **MMEMory:FORMat:READing:RLIMit**.
- The destination folder must exist and cannot be marked as hidden or system.
- If the destination file exists, it will be overwritten, unless marked as hidden or system.

MMEMory:UPLoad? <filename>

Uploads the contents of a file from the instrument to the host computer.

Parameter	Typical Return
Any valid file name	IEEE 488.2 definite-length block
Upload the state file "Myfile.sta" in the root directory of the internal flash file system to the host computer:	
MMEM:UPL? "INT:\Myfile.sta"	

SAMPlE Subsystem

The SAMPlE commands are used with the TRIGger commands to set up the triggering parameters. Use the SAMPlE commands to set a sample count, sample source, and delay time for triggered sampling.

NOTE

It is recommended that all triggered measurements be made using an appropriate fixed manual range. That is, turn autorange off (**SENSe:<function>:RANGe:AUTO OFF**), or set a fixed range using the **SENSe:<function>:RANGe**, **CONFigure**, or **MEASure** command.

Command Summary

SAMPlE:COUNT

SAMPlE:COUNT:PRETrigger

SAMPlE:SOURce

SAMPlE:TIMer

SAMPlE:COUNT {<count>|MIN|MAX|DEF}

SAMPlE:COUNT? [{MIN|MAX|DEF}]

Specifies the number of measurements (samples) the instrument takes per trigger.

Parameter	Typical Return
1 to 1,000,000 (1x10 ⁶). Default: 1. (34460A/61A)	+1
1 to 1,000,000,000 (1x10 ⁹). Default: 1. (34465A/70A)	
Return ten sets of four resistance measurements, using an external trigger to start each measurement set: CONF:RES 1E6 SAMP:COUN 4 TRIG:COUN 10 TRIG:SOUR EXT;SLOP NEG READ? Typical Response: +1.00520000E+06, ... (40 measurements)	

- The front panel sample annunciator ("*") turns on during each measurement at slower rates. The annunciator toggles at a fixed rate for fast measurements.
- You can use the specified sample count in conjunction with a trigger count (**TRIGger:COUNT**), which sets the number of triggers to be accepted before returning to the "idle" trigger state. The total number of measurements returned are the product of the sample count and trigger count.
- You can store up to 1,000 measurements in the reading memory of the 34460A, 10,000 measurements on the 34461A, 50,000 measurements on the 34465A/70A (*without* the MEM option), or 2,000,000 measurements on the 34465A/70A (*with* the MEM option). If reading memory overflows, new measurements overwrite the oldest measurements stored; the most recent measurements are always preserved. No error is generated, but the Reading Mem Ovfl bit (bit 14) is set in the Questionable Data Register's condition register (see **Status System Introduction**).

- MAX selects 1 billion readings. However, when pretrigger is selected, the maximum is 50,000 readings (*without* the MEM option) or 2,000,000 readings (*with* the MEM option).
- This parameter is set to its default value after a Factory Reset (***RST**) or Instrument Preset (**SYSTem:PRESet**).

SAMPlE:COUNT:PRETrigger {<count>|MIN|MAX|DEF}

SAMPlE:COUNT:PRETrigger? [{MIN|MAX|DEF}]

Allows collection of the data being digitized *before* the trigger. Reserves memory for pretrigger samples up to the specified number of pretrigger samples.

NOTE

It is recommended that all triggered measurements be made using an appropriate fixed manual range. That is, turn autorange off (**SENSe:<function>:RANGe:AUTO OFF**), or set a fixed range using the **SENSe:<function>:RANGe**, **CONFigure**, or **MEASure** command.

Parameter	Typical Return
0 to 1,999,999. Default: 0.	+999999
Configure AC voltage measurements using the 100 V range. Set the sample count to 10,000 and the pretrigger sample count to 5000 (5000 samples are taken before the trigger, and 5000 after). The trigger occurs when the input signal reaches 0.75 volts. CONF:VOLT:AC VOLT:AC:RANG 100 SAMP:COUN 10000 SAMP:COUN:PRET 5000 TRIG:SOUR INT TRIG:LEV 0.75 INIT	

- Applies only to the 34465A and 34470A.
- Pretrigger applies to all measurement functions except CONTinuity and DIODE test.
- Use **SAMPlE:COUNT** to set the *total* number of samples to take, then use **SAMPlE:COUNT:PRETrigger** to set the number of pretrigger samples to take.

For example, with a sample count of 50,000, and a pretrigger sample count of 20,000, up to 20,000 samples are taken before the trigger, then 30,000 samples are taken after the trigger occurs.

The sample count and pretrigger count do not affect when the trigger occurs. If the memory allocated for pretrigger samples fills up, the oldest readings are discarded. In the example above, the 20,000 *most recent* pretrigger samples are saved, even if more than 20,000 samples occur before the trigger. If the trigger occurs *before* the pretrigger count is satisfied, only the actual pretrigger samples taken are saved.

In all cases, after the trigger is received, only *sample count* minus *specified pretrigger count* readings are taken. In this example, if the trigger occurs after 5 pretrigger samples have been taken (instead of the specified 20,000), only 30,000 post-trigger samples are taken. This is because memory was reserved for 20,000 pretrigger samples.

- If a trigger occurs during a measurement, that measurement is considered to be a pretrigger sample.
- After setting the sample count and pretrigger sample count, you must place the DMM in the "wait-for-trigger" state using **INITiate** or **READ?** An external trigger is buffered until the DMM is in the "wait-for-trigger" state.
- The pretrigger sample count must be less than the sample count set with the **SAMPlE:COUNT** command, and there must be at least one post-trigger sample:

$$\text{Pretrigger Sample Count} \leq \text{Sample Count} - 1$$

- If any of the calculation functions are on (**CALC:STAT ON**), the pretrigger count is limited to 10,000 samples.
- **CONFigure** and **MEASure?** set the pretrigger sample count to "0".
- The instrument sets the pretrigger sample count to "0" after a Factory Reset (***RST** command) or a Preset (**SYSTem:PRESet** command).

See Also

SAMPlE:COUNT

SAMPlE:SOURce {IMMEDIATE|TIMER}
SAMPlE:SOURce?

Determines sample timing, with **TRIGger:DELay** and **SAMPlE:TIMer** to determine sample timing, when the sample count is greater than one.

NOTE It is recommended that all triggered measurements be made using an appropriate fixed manual range. That is, turn autorange off (**SENSe:<function>:RANGe:AUTO OFF**), or set a fixed range using the **SENSe:<function>:RANGe**, **CONFigure**, or **MEASure** command.

Parameter	Typical Return
{IMMEDIATE TIMER}. Default: IMMEDIATE.	IMM or TIM
Set sample source to timer. The INIT command sets the meter to the "wait-for-trigger" state. When a trigger is received from the selected trigger source, the instrument starts taking periodic samples after the trigger delay.	
SAMP:SOUR TIM SAMP:TIM 0.1 INIT	

Operation

In all cases, the first sample is taken one trigger delay time after the trigger (the delay being set with the **TRIGger:DELay** command). Beyond that, the timing mechanism depends on whether you select IMMEDIATE (default) or TIMER as the source:

- IMMEDIATE - The first sample starts one trigger delay time after the trigger, and then the trigger delay time is inserted between the first and second samples, the second and third, and so on:

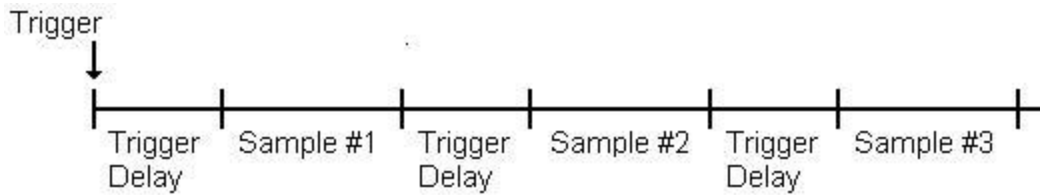

The sample timing *is not* deterministic because the delay time (set with **TRIGger:DElay**) is inserted *after* each sample completes. The actual time required to take each sample depends on the integration time and autoranging time. In this case, the **SAMple:TIMer** command has no effect.

- **TIMer** - The first sample starts one trigger delay time after the trigger. However, the second sample starts one sample interval after the start of the first sample, and so on:

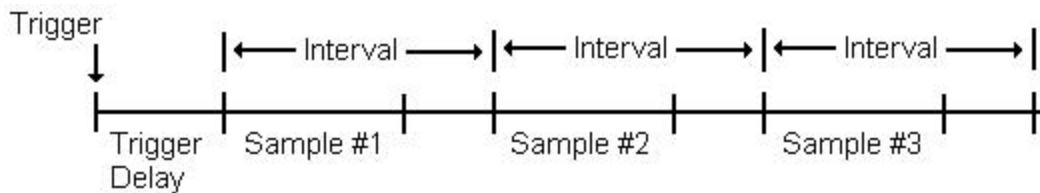

The sample timing *is* deterministic because the start of each sample is determined by the sample interval, set with the **SAMple:TiMer** command (**TRIGger:DElay** affects only the start of the first sample). Integration and autoranging affect the sampling time for each sample, but not the sample interval as long as the sample interval is longer than the sampling time.

Remarks

- Applies only to the 34465A and 34470A.
- This command has no effect if the sample count is 1 (see **SAMple:COUnT**).
- After setting the sample count, sample source, and the sample interval or trigger delay time, you must place the instrument in the "wait-for-trigger" state using the **INITiate** or **READ?** command. A trigger is not accepted from the selected trigger source (see **TRIGger:SOURce** command) until the instrument is in the "wait-for-trigger" state.
- The instrument sets the sample source to "IMM" after a Factory Reset (***RST** command) or an instrument Preset (**SYSTem:PRESet** command).

See Also

TRIGger:COUnT

TRIGger:DElay

TRIGger:SOURce

SAMple:COUnT

SAMple:TIMer

SAMPle:TIMer {<interval>|MIN|MAX|DEF}

SAMPle:TIMer? [{MIN|MAX|DEF}]

Sets a sample interval for timed sampling (**SAMPle:SOURce TIMer**) when the sample count is greater than one.

The first sample is taken one trigger delay time after the trigger (delay set by **TRIGger:DELay**). The second sample starts one sample interval after the start of the first sample, and so forth, as shown below:

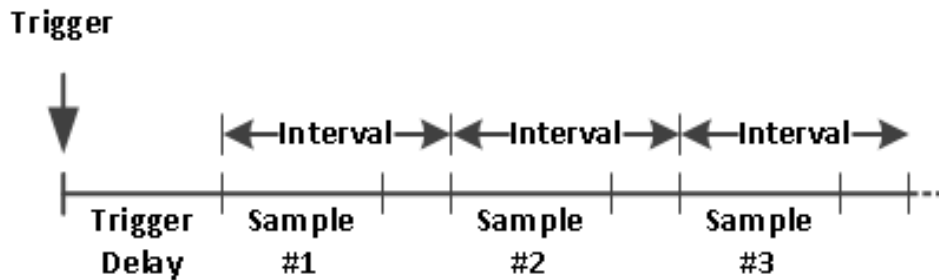

Note that the sample timing is determinant because the start of each sample is determined by the sample interval. Integration and autoranging affect the sampling time for each sample, but not the sample interval as long as the sample interval is longer than the sampling time. Periodic sampling continues until the sample count (set with the **SAMPle:COUNt** command) is satisfied.

NOTE

It is recommended that all triggered measurements be made using an appropriate fixed manual range. That is, turn autorange off (**SENSe:<function>:RANGe:AUTO OFF**), or set a fixed range using the **SENSe:<function>:RANGe, CONFigure**, or **MEASure** command. When autorange is left on, the starting time of a sample becomes uncertain (when a range change occurs) and when ranging exceeds the interval between samples; then all subsequent samples become offset from their desired start points.

Parameter	Typical Return
<interval> MIN (see bullet points below) to 3600 seconds (~1 μs steps).	+3.60000000E+003
Set the sample interval to 0.1 seconds. INIT sets the meter to the "wait-for-trigger" state. When a trigger is received from the selected trigger source, the instrument waits the trigger delay time, and then takes readings every 0.10 seconds until the sample count is satisfied.	
SAMP:SOUR TIM SAMP:TIM 0.1 INIT	

- The value of MIN is measurement dependent. It depends on such things as the integration time, autozero on or off, autorange on or off, and the measurement range. Basically, MIN is automatically determined so that the sample interval is always greater than the sampling time (see above illustration). Execute **SAMPle:TIMer? MIN** to determine the recommended interval for the current measurement configuration.

- Since the minimum value changes depending on configuration, a command order dependency exists. You must completely configure the measurement before setting the sample timer to MIN, or you may generate an error. A complete configuration includes such things as math statistics or scaling.
- When using autorange, the MIN value is the *recommended* value, not the *absolute minimum* value. With autorange enabled, MIN is calculated assuming a single range change will occur for every measurement (not multiple ranges, just one range up or down per measurement). You can specify an *<interval>* between the absolute minimum (assumes no range changes) and the recommended MIN value, but it may generate a timing violation error when making measurements. Applying a value less than the absolute minimum will generate an error.
- To determine the absolute minimum value for the present configuration, set the sample time to 20 μs (which may generate a settings conflict error), then read back the current sample timer value using the `SAMPle:TIMer?` query. The sample source must be set to timer with a sample count or trigger count greater than 1, for the settings conflict error to occur. The settings conflict error causes the timer to be set to the absolute minimum value.
- The sample time resolution is 1 μs , the aperture resolution is 2 μs , and the actual hardware resolution is not exactly 1 μs . There are cases where a sample time value, rounded to the nearest hardware resolution, will result in a smaller value than aperture when rounded to 2 μs . This will create error -221, "*Settings conflict; cannot meet requested timing; SAMP:TIM changed*". For example, the following sequence of commands generates error -221 and sets the sample time to +2.00100000E-003.

```
*RST
FUNC "VOLT:DC"
VOLT:DC:APER 0.002
VOLT:DC:RANGE:AUTO OFF
VOLT:DC:ZERO:AUTO OFF
TRIG:DEL 0
TRIG:SOUR BUS
SAMP:COUN 2
SAMP:TIM 0.002
SAMP:SOUR TIM
```

This error can also occur if you attempt to set both values an odd number of μs . For example, setting both values to 23 μs , generates error -221 and sets the sample timer to 24 μs .

- After setting the sample count, source, and delay time, you must place the meter in the "wait-for-trigger" state using the `INITiate` or `READ?` command. A trigger is not accepted from the selected trigger source (see `TRIGger:SOURce` command) until the instrument is in the "wait-for-trigger" state.
- The interval may be set to any value from the absolute minimum described above to 3600 seconds. However, the value is rounded to the nearest step. For dc measurements, the step size is 1 μs . For ac measurements, it is ac bandwidth dependent.
- The instrument sets the sample timer to 1 second after a reset (`*RST` command) or an instrument preset (`SYSTem:PRESet` command).

See Also

`TRIGger:COUNT`

SCPI Programming Reference

TRIGger:DElay

TRIGger:SOURce

SAMPlE:COUNT

SAMPlE:SOURce

SENSe Subsystem Introduction

The SENSe subsystem configures measurements. The most basic SENSe command is **[SENSe:]FUNction[:ON]**, which selects the measurement function. All other SENSe commands are associated with specific measurement types:

Capacitance (34465A and 34470A only)

Current

Data2

Frequency and Period

2-Wire and 4-Wire Resistance

Temperature

Voltage

[SENSe:]FUNction[:ON] "<function>"
[SENSe:]FUNction[:ON]?

Selects the measurement function (all function-related measurement attributes are retained).

Parameter	Typical Return
CAPacitance CONTinuity CURRent:AC CURRent[:DC] DIODE FREQuency FREStance PERiod RESistance TEMPerature VOLTage:AC VOLTage[:DC] VOLTage[:DC]:RATio The default is VOLTage[:DC].	The short form of the selected function is returned in quotation marks, with no optional keywords: "CONT", "CURR:AC", "CURR", "DIOD", and so on.
Select the AC voltage function: FUNC "VOLT:AC"	

- If you change the measurement function, all measurement attributes of the previous function (range, resolution, etc.) are remembered. If you return to the original function, those measurement attributes are restored.
- Changing the measurement function disables scaling, limit testing, histogram, statistics, and trend chart data collection (**CALC:SCAL:STAT**, **CALC:LIM:STAT**, **CALC:TRAN:HIST:STAT**, **CALC:AVER:STAT**, and **CALC:TCH:STAT** set to OFF).
- This parameter is set to its default value after a Factory Reset (***RST**) or Instrument Preset (**SYSTem:PRESet**).

[SENSe:]CAPacitance Subsystem

This subsystem configures capacitance measurements.

Command Summary

[SENSe:]CAPacitance:NULL[:STATe]

[SENSe:]CAPacitance:NULL:VALue

[SENSe:]CAPacitance:NULL:VALue:AUTO

[SENSe:]CAPacitance:RANGe:AUTO

[SENSe:]CAPacitance:RANGe

[SENSe:]CAPacitance:SECondary

[SENSe:]CAPacitance:NULL[:STATe] {ON|1|OFF|0}

[SENSe:]CAPacitance:NULL[:STATe]?

Turns the null function on or off for capacitance measurements.

Parameter	Typical Return
{ON 1 OFF 0}. Default: ON.	0 (OFF) or 1 (ON)
Configure capacitance measurements, turn null function on, use the AUTO null function. Make two measurements and send them to the instrument's output buffer: CONF:CAP AUTO CAP:NULL ON CAP:NULL:VAL:AUTO ON SAMP:COUN 2 READ? Typical Response: +3.01963841E-10,+3.01566277E-10	

- Enabling the scaling function also enables automatic null value selection ([SENSe:]CAPacitance:NULL:VALue:AUTO).
- To set a fixed null value, use: [SENSe:]CAPacitance:NULL:VALue.
- The instrument disables the null function after a Factory Reset (*RST), Instrument Preset (SYSTem:PRESet), or CONFIgure function.

[SENSe:]CAPacitance:NULL:VALue {<value>|MIN|MAX|DEF}
 [SENSe:]CAPacitance:NULL:VALue? [{MIN|MAX|DEF}]

Stores a null value for capacitance measurements. The null value is subtracted from each sample if the null state is turned on.

Parameter	Typical Return
<value> -120 to +120 μ F. Default: 0.	-1.20000000E-04
Configure capacitance measurements, turn null function on. Make two measurements and send them to the instrument's output buffer: CONF:CAP AUTO CAP:NULL ON CAP:NULL:VAL 1.2E-12 SAMP:COUN 2 READ? Typical Response: +3.01963841E-10,+3.01566277E-10	

- Specifying a null value disables automatic null value selection ([SENSe:]CAPacitance:NULL:VALue:AUTO OFF).
- To use the null value, turn on the null state with the [Sense:]CAPacitance:NULL[:STATe] command.
- This parameter is set to its default value after a Factory Reset (*RST), Instrument Preset (SYSTem:PRESet), or CONFigure function.

[SENSe:]CAPacitance:NULL:VALue:AUTO {ON|1|OFF|0}

[SENSe:]CAPacitance:NULL:VALue:AUTO?

Enables or disables automatic null value selection for capacitance measurements.

Parameter	Typical Return
{ON 1 OFF 0}. Default: ON.	0 (OFF) or 1 (ON)
Configure capacitance measurements, turn null function on, use the AUTO null function. Make two measurements and send them to the instrument's output buffer: CONF:CAP AUTO CAP:NULL ON CAP:NULL:VAL:AUTO ON SAMP:COUN 2 READ? Typical Response: +3.01963841E-10,+3.01566277E-10	

- When automatic reference selection is ON, the first measurement made is used as the null value for all subsequent measurements. **[SENSe:]CAPacitance:NULL:VALue** is set to this value. Automatic null value selection will be disabled.
- When automatic null value selection is disabled (OFF), the null value is specified by: **[SENSe:]CAPacitance:NULL:VALue**.
- The instrument enables automatic null value selection when the null function is enabled (**[SENSe:]CAPacitance:NULL:STATe ON**).
- This parameter is set to its default value after a Factory Reset (***RST**), Instrument Preset (**SYSTem:PRESet**), or CONFIgure function.

[SENSe:]CAPacitance:RANGe:AUTO {OFF|ON|ONCE}

[SENSe:]CAPacitance:RANGe:AUTO?

Disables or enables autoranging for capacitance measurements.

Parameter	Typical Return
{OFF ON ONCE}. Default: ON.	0 (OFF) or 1 (ON)
Configure capacitance measurements, turn autorange on, turn null function on, use the AUTO null function. Make two measurements and send them to the instrument's output buffer: CONF:CAP CAP:RANG:AUTO ON CAP:NULL ON CAP:NULL:VAL:AUTO ON SAMP:COUN 2 READ? Typical Response: +3.01963841E-10,+3.01566277E-10	

- Autoranging goes down a range at less than 10% of range and up a range at greater than 120% of range. For capacitance measurements only, when autorange is off, the instrument does not report an overload for readings greater than 120% of range. Overload only occurs when the algorithm times out because the applied capacitance is too large for the algorithm to measure. If you apply a DC voltage or a short to the input terminals in capacitance measurement mode, the instrument reports an overload.
- ONCE performs an immediate autorange, and then sets autoranging to OFF. (Thus, the query returns "0".)
- Selecting a discrete range (see [Sense:]CAPacitance:RANGe command) disables autoranging.
- This parameter is set to its default value after a Factory Reset (*RST) or Instrument Preset (SYSTEM:PRESet).

[SENSe:]CAPacitance:RANGe {<range>|MIN|MAX|DEF}
 [SENSe:]CAPacitance:RANGe? [{MIN|MAX|DEF}]

Selects a fixed range for capacitance measurements.

Parameter	Typical Return
<range>: {1 nF 10 nF 100 nF 1 µF 10 µF 100 µF}. Default: AUTO.	+1.00000000E-09
Configure capacitance measurements, select 1 nF range, turn null function on, use the AUTO null function. Make two measurements and send them to the instrument's output buffer: CONF:CAP CAP:RANG 1 nF or CAP:RANG 1.0E-9 CAP:NULL ON CAP:NULL:VAL:AUTO ON SAMP:COUN 2 READ? Typical Response: +3.01963841E-10,+3.01566277E-10	

- Selecting a fixed range ([SENSe:]<function>:RANGe) disables autoranging.
- If the input signal is greater than can be measured on the specified fixed range, the instrument displays *Overload* on front panel and returns "9.9E37" from the remote interface.
- This parameter is set to its default value after a Factory Reset (*RST) or Instrument Preset (SYSTEM:PRESet).

[SENSe:]CAPacitance:SEConDary {"OFF"|"CALCulate:DATA"}
 [SENSe:]CAPacitance:SEConDary?

Selects the secondary measurement function for capacitance measurements.

Parameter	Typical Return
{"OFF" "CALCulate:DATA"}, default "OFF"	"CALC:DATA"
Configure capacitance and secondary measurements. Make capacitance measurement and retrieve secondary measurement. CONF:CAP AUTO,MAX CAP:SEC "CALC:DATA" READ?;DATA2? Typical Response: +3.01566373E-10;+3.01566373E-10	

- "CALCulate:DATA" - The measurement value before any math operations are done (including NULL).
- Use **READ?** or **INITiate** to start the measurement. Use [SENSe:]**DATA2?** to retrieve the secondary measurement.
- This parameter is set to its default value after a Factory Reset (***RST**) or Instrument Preset (**SYSTem:PRESet**).

[SENSe:]CURRent Subsystem

This subsystem configures AC and DC current measurements.

Command Summary

[SENSe:]CURRent:AC:BANDwidth

[SENSe:]CURRent:{AC|DC}:NULL[:STATe]

[SENSe:]CURRent:{AC|DC}:NULL:VALue

[SENSe:]CURRent:{AC|DC}:NULL:VALue:AUTO

[SENSe:]CURRent:{AC|DC}:RANGe

[SENSe:]CURRent:{AC|DC}:RANGe:AUTO

[SENSe:]CURRent:{AC|DC}:TERMinals

[SENSe:]CURRent:AC:SECOndary

[SENSe:]CURRent[:DC]:APERture

[SENSe:]CURRent[:DC]:APERture:ENABled

[SENSe:]CURRent[:DC]:NPLC

[SENSe:]CURRent[:DC]:RESolution

[SENSe:]CURRent[:DC]:SECOndary

[SENSe:]CURRent[:DC]:ZERO:AUTO

[SENSe:]CURRent:SWITCh:MODE

[SENSe:]CURRent:AC:BANDwidth {<filter>|MIN|MAX|DEF}
 [SENSe:]CURRent:AC:BANDwidth? [{MIN|MAX|DEF}]

Sets the bandwidth for AC current measurements.

The instrument uses three different AC filters that enable you either to optimize low frequency accuracy or to achieve faster AC settling times following a change in input signal amplitude.

NOTE On the 34461A, 34465A, or 34470A, use the [SENSe:]CURRent:{AC|DC}:TERMinals command to specify which current terminals to use for the measurement.

Parameter	Typical Return
{3 Hz 20 Hz 200 Hz}. Default: 20Hz.	+2.00000000E+01
Make and read an AC current measurement. Use the 3 Hz filter bandwidth: CONF:CURR:AC 1 CURR:AC:BAND 3 READ? Typical Response: +5.23918293E+00	

- If you enter the lowest expected frequency that you intend to encounter, the command will select the appropriate <filter>. For example, if you enter 15 Hz, the slow filter (3 Hz) is selected. If you enter 190 Hz, the medium filter (20 Hz) is selected to provide the appropriate low cutoff.
- Set the lowest frequency that you expect to encounter. Lower bandwidths result in longer settling delays, as shown:

Input Frequency	Default Settling Delay
3 Hz - 300 kHz (<i>Slow</i>)	1.66 s/measurement
20 Hz - 300 kHz (<i>Medium</i>)	0.25 s/measurement
200 Hz - 300 kHz (<i>Fast</i>)	0.025 s/measurement

- This parameter is set to its default value after a Factory Reset (*RST) or Instrument Preset (SYSTem:PRESet).

[SENSe:]CURREnt:{AC|DC}:NULL[:STATe] {ON|1|OFF|0}
 [SENSe:]CURREnt:{AC|DC}:NULL[:STATe]?

Enables or disables the null function for AC or DC current measurements.

NOTE This parameter setting is not shared between AC and DC measurements. The parameters are independent for AC and DC measurements.

NOTE On the 34461A, 34465A, or 34470A, use the [SENSe:]CURREnt:{AC|DC}:TERMinals command to specify which current terminals to use for the measurement.

Parameter	Typical Return
{ON 1 OFF 0}. Default: OFF.	0 (OFF) or 1 (ON)
Configure AC current measurements, using the null function to subtract 100 mA from the measurements. Then make two measurements and send them to the instrument's output buffer: CONF:CURR:AC CURR:AC:NULL:STAT ON;VAL 100 mA SAMP:COUN 2 READ? Typical Response: +1.04530000E+00,+1.04570000E+00	

- Enabling the scaling function also enables automatic null value selection ([SENSe:]CURREnt:{AC|DC}:NULL:VALue:AUTO ON).
- To set a fixed null value, use: [SENSe:]CURREnt:{AC|DC}:NULL:VALue.
- The instrument disables the null function after a Factory Reset (*RST), Instrument Preset (SYSTem:PRESet), or CONFIgure function.

[SENSe:]CURRent:{AC|DC}:NULL:VALue {<value>|MIN|MAX|DEF}
[SENSe:]CURRent:{AC|DC}:NULL:VALue? [{MIN|MAX|DEF}]

Sets the null value for AC or DC current measurements.

NOTE This parameter setting is not shared between AC and DC measurements. The parameters are independent for AC and DC measurements.

NOTE On the 34461A, 34465A, or 34470A, use the **[SENSe:]CURRent:{AC|DC}:TERMinals** command to specify which current terminals to use for the measurement.

Parameter	Typical Return
-12 to 12 A. Default: 0	+1.04530000E+00
Configure AC current measurements, using the null function to subtract 100 mA from the measurements. Then make two measurements and send them to the instrument's output buffer: CONF:CURR:AC CURR:AC:NULL:STAT ON;VAL 100 mA SAMP:COUN 2 READ? Typical Response: +1.04530000E+00,+1.04570000E+00	

- Specifying a null value disables automatic null value selection (**[SENSe:]CURRent:{AC|DC}:NULL:VALue:AUTO OFF**).
- To use the null value, the null state must be on (**[SENSe:]CURRent:{AC|DC}:NULL:STATe ON**).
- This parameter is set to its default value after a Factory Reset (***RST**), Instrument Preset (**SYSTem:PRESet**), or CONFigure function.

[SENSe:]CURRent:{AC|DC}:NULL:VALue:AUTO {ON|1|OFF|0}
 [SENSe:]CURRent:{AC|DC}:NULL:VALue:AUTO?

Enables or disables automatic null value selection for AC or DC current measurements.

- NOTE** This parameter setting is not shared between AC and DC measurements. The parameters are independent for AC and DC measurements.
- NOTE** On the 34461A, 34465A, or 34470A, use the [SENSe:]CURRent:{AC|DC}:TERMinals command to specify which current terminals to use for the measurement.

Parameter	Typical Return
{ON 1 OFF 0}. Default: ON.	0 (OFF) or 1 (ON)
Configure AC current measurements, using the null function to subtract 100 mA from the measurements. Then make two measurements and send them to the instrument's output buffer: CONF:CURR:AC CURR:AC:NULL:STAT ON;VAL 100 mA SAMP:COUN 2 READ? Typical Response: +1.04530000E+00,+1.04570000E+00 Make a second set of measurements using automatic null value selection: CURR:AC:NULL:VAL:AUTO ON READ? Typical Response: +0.00000000E+00,+0.01420000E+00	

- When automatic reference selection is ON, the first measurement made is used as the null value for all subsequent measurements. [SENSe:]CURRent:{AC|DC}:NULL:VALue is set to this value. Automatic null value selection will be disabled.
- When automatic null value selection is disabled (OFF), the null value is specified by: [SENSe:]CURRent:{AC|DC}:NULL:VALue.
- The instrument enables automatic null value selection when the null function is enabled ([SENSe:]CURRent:{AC|DC}:NULL:STATe ON).
- This parameter is set to its default value after a Factory Reset (*RST), Instrument Preset (SYSTem:PRESet), or CONFigure function.

[SENSe:]CURRent:{AC|DC}:RANGe {<range>|MIN|MAX|DEF}
[SENSe:]CURRent:{AC|DC}:RANGe? [{MIN|MAX|DEF}]

Selects a fixed measurement range for AC or DC current measurements on the 3 A terminals. For DMMs with a 10 A range, you cannot select the 10 A range with this command; instead, use **[SENSe:]CURRent:{AC|DC}:TERMinals 10** or **CONF:CURRent:{AC|DC} 10**.

- NOTE** This parameter setting is not shared between AC and DC measurements. The parameters are independent for AC and DC measurements.
- NOTE** On the 34461A, 34465A, or 34470A, use the **[SENSe:]CURRent:{AC|DC}:TERMinals** command to specify which current terminals to use for the measurement.

Parameter	Typical Return
<range> : {100 µA 1 mA 10 mA 100 mA 1 A 3 A}. Default: AUTO (autorange). The 34465A/70A have additional DC current ranges of 1 µA and 10 µA.	+1.00000000E-01
Configure AC current measurements using the 1 A range. Make and read two measurements: CONF:CURR:AC CURR:AC:RANG 1 SAMP:COUN 2 READ? Typical Response: +1.04530000E+00,+1.04570000E+00	

- Selecting a fixed range ([SENSe:]<function>:RANGe) disables autoranging.
- If the input signal is greater than can be measured on the specified manual range, the instrument displays the word *Overload* on front panel and returns "9.9E37" from the remote interface.
- Unlike CONFigure and MEASure?, this command does not support the 10 A range. Selecting the 10 A terminal with **[SENSe:]CURRent:{AC|DC}:TERMinals** forces the specified type of current measurements to use the 10 A range, but it does not affect the values of **[SENSe:]CURRent:{AC|DC}:RANGe** or **[SENSe:]CURRent:{AC|DC}:RANGe:AUTO**.
- Changing the value of this parameter always changes the measurement resolution. The number of PLCs (NPLC) stays fixed, and this results in a change of resolution in terms of the units of the measurement. For example, if you have a measurement with 1 µA resolution on the 100 mA range, changing to the 1 A range results in a resolution of 10 µA.
- This parameter is set to its default value after a Factory Reset (***RST**) or Instrument Preset (**SYSTem:PRESet**).

[SENSe:]CURRent:{AC|DC}:RANGe:AUTO {OFF|ON|ONCE}
 [SENSe:]CURRent:{AC|DC}:RANGe:AUTO?

Disables or enables autoranging for AC or DC current measurements. Autoranging is convenient because it automatically selects the range for each measurement based on the input signal.

Specifying ONCE performs an immediate autorange and then turns autoranging off.

NOTE This parameter setting is not shared between AC and DC measurements. The parameters are independent for AC and DC measurements.

NOTE On the 34461A, 34465A, or 34470A, use the [SENSe:]CURRent:{AC|DC}:TERMinals command to specify which current terminals to use for the measurement.

Parameter	Typical Return
{ON 1 OFF 0}. Default: ON.	0 (OFF) or 1 (ON)
Configure AC current measurements and perform an immediate autorange. Make and read two measurements: CONF:CURR:AC CURR:AC:RANG:AUTO ONCE SAMP:COUN 2 READ? Typical Response: +1.04530000E-01,+1.04570000E-01	

- Autoranging goes down a range at less than 10% of range and up a range at greater than 120% of range.
- With autoranging enabled, the instrument selects the range based on the input signal.
- Selecting a fixed range ([SENSe:]<function>:RANGe) disables autoranging.
- Selecting the 10 A terminal with [SENSe:]CURRent:{AC|DC}:TERMinals forces the specified type of current measurements to use the 10 A range, but it does not affect the values of [SENSe:]CURRent:{AC|DC}:RANGe or [SENSe:]CURRent:{AC|DC}:RANGe:AUTO.
- This parameter is set to its default value after a Factory Reset (*RST) or Instrument Preset (SYSTem:PRESet).

[SENSe:]CURRent:{AC|DC}:TERMinals {3|10}
[SENSe:]CURRent:{AC|DC}:TERMinals?

Configures the AC or DC current measurement to measure the source on the 3 A or 10 A terminals. Note that the 10 A terminal is not available on the 34460A.

Parameter	Typical Return
{3 10}. Default: 3.	+3 or +10
Configure AC current measurements to use the 10 A terminal. Make and read two measurements: CONF:CURR:AC CURR:AC:TERM 10 SAMP:COUN 2 READ? Typical Response: +7.81929394E+00,7.82013671E+00	

- Selecting the 10 A terminal with **[SENSe:]CURRent:{AC|DC}:TERMinals** forces the specified type of current measurements to use the 10 A range, but it does not affect the values of **[SENSe:]CURRent:{AC|DC}:RANGe** or **[SENSe:]CURRent:{AC|DC}:RANGe:AUTO**.
- Changing the value of this parameter always changes the measurement range, which results in a change of measurement resolution. The number of PLCs (NPLC) stays fixed, and this results in a change of resolution in terms of the units of the measurement. For example, if you have a measurement with 1 μ A resolution on the 1 A range, changing to the 10 A terminals results in a resolution of 10 μ A.
- This parameter is set to its default value after a Factory Reset (***RST**) or Instrument Preset (**SYSTem:PRESet**).

[SENSe:]CURRent:AC:SECOndary {"OFF"|"CALCulate:DATA"|"FREQUency"|"CURRent[:DC]"}
 [SENSe:]CURRent:AC:SECOndary?

Selects the secondary measurement function for AC current measurements.

Parameter	Typical Return
{"OFF" "CALCulate:DATA" "FREQUency" "CURRent[:DC]"}, default "OFF"	"CALC:DATA"
Configure AC current measurements using the 1 A range. Select frequency as the secondary measurement. Make and retrieve measurements. CONF:CURR:AC 1 CURR:AC:SEC "FREQ" READ?;DATA2? Typical Response: +0.50000000E+00;+1.00000000E+03	

- "CALCulate:DATA" - (Applies only to the 34465A and 34470A.) The measurement value before any math operations are done (including NULL).
- "FREQUency" - The frequency measurement of the input signal.
- "CURRent[:DC]" - The DC current measurement of the input signal. Applies only when using the instrument from the front panel. Setting is ignored for measurements made from a remote interface. If you require both AC and DC current measurements from remote, program each function separately, see **CONFigure:CURRent:{AC|DC}**.
- This parameter is set to its default value after a Factory Reset (***RST**) or Instrument Preset (**SYSTem:PRESet**).

[SENSe:]CURRent[:DC]:APERture {<seconds>|MIN|MAX|DEF}
 [SENSe:]CURRent[:DC]:APERture? [{MIN|MAX|DEF}]

Specifies the integration time in seconds (called *aperture time*) for dc current measurements.

NOTE Use this command for precise control of the DMM's integration time. Use NPLC (see **[SENSe:]CURRent[:DC]:NPLC**) for better power-line noise rejection characteristics (NPLC > 1).

Parameter	Typical Return
(Without the DIG option) 200 μs to 1 s (2 μs resolution), default: 100 ms. (With the DIG option) 20 μs to 1 s (2 μs resolution), default: 100 ms.	+1.00000000E-01
Enable aperture time mode, set the aperture time to 300 ms: CURR:APER:ENAB ON CURR:DC:APER 300E-03	

- Applies only to the 34465A and 34470A.
- Both the [SENSe:]<function>:NPLC and [SENSe:]<function>:APERTure commands control the instrument's integration time. When using both commands (not recommended), whichever command is sent last will override the other command and set the integration time. Sending the [SENSe:]<function>:APERTure command sets the [SENSe:]<function>:APERTure:ENABLEd command to 1 (ON); sending [SENSe:]<function>:NPLC sets it to 0 (OFF).
- This parameter is set to its default value after a Factory Reset (*RST) or Instrument Preset (SYSTem:PRESet).

[SENSe:]CURRent[:DC]:APERTure:ENABLEd {ON|1|OFF|0}

[SENSe:]CURRent[:DC]:APERTure:ENABLEd?

Enables the setting of integration time in seconds (called *aperture time*) for dc current measurements. If aperture time mode is disabled (default), the integration time is set in PLC (power-line cycles).

Parameter	Typical Return
{ON 1 OFF 0}. Default: OFF.	0 (OFF) or 1 (ON)
Enable aperture time mode, set the aperture time to 300 ms: CURR:APER:ENAB ON CURR:DC:APER 300E-03	

- Applies only to the 34465A and 34470A.
- The CONFigure:CURRent[:DC], MEASure:CURRent[:DC]?, [SENSe:]CURRent[:DC]:NPLC, and [SENSe:]CURRent[:DC]:RESolution commands disable the aperture time mode, and select an integration time in number of power line cycles.
- This parameter is set to its default value after a Factory Reset (*RST) or Instrument Preset (SYSTem:PRESet).

[SENSe:]CURRent[:DC]:NPLC {<PLC>|MIN|MAX|DEF}
[SENSe:]CURRent[:DC]:NPLC? [{MIN|MAX|DEF}]

Sets the integration time in number of power line cycles (PLC) for DC current measurements. Integration time is the period that the instrument's analog-to-digital (A/D) converter samples the input signal for a measurement. A longer integration time gives better measurement resolution but slower measurement speed.

NOTE On the 34461A, 34465A, or 34470A, use the **[SENSe:]CURRent:{AC|DC}:TERMinals** command to specify which current terminals to use for the measurement.

Parameter	Typical Return
0.02, 0.2, 1, 10, 100. Default: 10 (34460A/61A) 0.02, 0.06, 0.2, 1, 10, 100. Default: 10 (34465A/70A without DIG option) 0.001, 0.002, 0.006, 0.02, 0.06, .2, 1, 10, 100. Default: 10 (34465A/70A with DIG option) See Range, Resolution and NPLC for more information.	+1.00000000E+00
Configure DC current measurements using a 10 PLC integration time. Then make and read one measurement: CONF:CURR:DC CURR:DC:NPLC 10 READ? Typical Response: +6.27530000E-01	

- Selecting an integration time in power line cycles overrides an aperture set with the **[SENSe:]CURRent[:DC]:APERTure** command.
- Only integration times of 1, 10, or 100 PLC provide normal mode (line frequency noise) rejection.
- Setting the integration time also sets the measurement resolution. **Resolution Table** shows the relationship between integration time and resolution.
- This parameter is set to its default value after a Factory Reset (***RST**) or Instrument Preset (**SYSTem:PRESet**).

See Also

[SENSe:]CURRent[:DC]:RESolution

[SENSe:]CURRent[:DC]:RESolution {<resolution>|MIN|MAX|DEF}
[SENSe:]CURRent[:DC]:RESolution? [{MIN|MAX|DEF}]

Selects the measurement resolution for DC current measurements. Specify the resolution in the same units as the selected measurement function, not in number of digits.

NOTE On the 34461A, 34465A, or 34470A, use the **[SENSe:]CURRent:{AC|DC}:TERMinals** command to specify which current terminals to use for the measurement.

Parameter	Typical Return
Specify <resolution> in the measurement's units (V, A, Hz, Ω, and so on).	+3.00000000E-05
Configure DC current measurements with a 3 μA resolution. Then make and read one measurement: CONF:CURR:DC 1 CURR:DC:RES 3E-6 READ? Typical Response: +6.27531500E-01	

- You can specify MIN (best resolution) or MAX (worst resolution) instead of <resolution>.
- To achieve normal mode (line frequency noise) rejection, use a resolution that corresponds to an integration time that is an integral number of power line cycles.
- This parameter is set to its default value after a Factory Reset (***RST**) or Instrument Preset (**SYSTem:PRESet**).

See Also

[SENSe:]CURRent[:DC]:NPLC

[SENSe:]CURRent[:DC]:SECondary {"OFF"|"CALCulate:DATA"|"CURRent:AC"|"PTPeak"}
 [SENSe:]CURRent[:DC]:SECondary?

Selects the secondary measurement function for DC current measurements.

Parameter	Typical Return
{"OFF" "CALCulate:DATA" "CURRent:AC" "PTPeak"}, default "OFF"	"CALC:DATA"
Configure DC current measurements using the 1 A range with 1 mA resolution. Select peak-to-peak as the secondary measurement. Make and retrieve measurements. CONF:CURR:DC 1,0.001 CURR:DC:SEC "PTP" READ?;DATA2? Typical Response: +5.54141768E-06;+9.91000000E+3,+9.91000000E+3	

- "CALCulate:DATA" - (Applies only to the 34465A and 34470A.) The measurement value before any math operations are done (including NULL).
- "CURRent:AC" - The AC current measurement of the input signal. Applies only when using the instrument from the front panel. Setting is ignored for measurements made from a remote interface. If you require both AC and DC current measurements from remote, program each function separately, see [CONFigure:CURRent:{AC|DC}](#).
- "PTPeak" - The peak-to-peak, maximum, and minimum values of the input signal.
- This parameter is set to its default value after a Factory Reset (***RST**) or Instrument Preset (**SYSTem:PRESet**).

[SENSe:]CURRent[:DC]:ZERO:AUTO {OFF|ON|ONCE}
[SENSe:]CURRent[:DC]:ZERO:AUTO?

Disables or enables the autozero mode for DC current measurements.

NOTE On the 34461A, 34465A, or 34470A, use the **[SENSe:]CURRent:{AC|DC}:TERMinals** command to specify which current terminals to use for the measurement.

Parameter	Typical Return
{OFF ON ONCE}. Default: ON.	0 (OFF) or 1 (ON)
Configure DC current measurements and perform an immediate autozero. Make and read two measurements: CONF:CURR:DC 1 CURR:DC:ZERO:AUTO ONCE SAMP:COUN 2 READ? Typical Response: +1.04530000E-01,+1.04570000E-01	

- **ON (default):** the DMM internally measures the offset following each measurement. It then subtracts that measurement from the preceding reading. This prevents offset voltages present on the DMM's input circuitry from affecting measurement accuracy.
- **OFF:** the instrument uses the last measured zero measurement and subtracts it from each measurement. It takes a new zero measurement each time you change the function, range or integration time.
- **ONCE:** the instrument takes one zero measurement and sets autozero OFF. The zero measurement taken is used for all subsequent measurements until the next change to the function, range or integration time. If the specified integration time is less than 1 PLC, the zero measurement is taken at 1 PLC to optimize noise rejection. Subsequent measurements are taken at the specified fast (< 1 PLC) integration time.
- The autozero mode is set indirectly when you set the resolution and integration time with **CONFigure:CURRent:DC** or **MEASure:CURRent:DC?**. Autozero is automatically turned OFF when you select an integration time less than 1 PLC with these commands.
- This parameter is set to its default value after a Factory Reset (***RST**) or Instrument Preset (**SYSTem:PRESet**).

[SENSe:]CURRent:SWITCh:MODE {FAST|CONTInuous}
 [SENSe:]CURRent:SWITCh:MODE?

Selects the FAST or CONTInuous range change mode for AC and DC current measurements.

Parameter	Typical Return
{FAST CONTInuous}. Default: CONT	CONT
Configure DC current measurements on the 1 mA range. Specify CONTInuous mode. Make and read two measurements: CONF:CURR:DC .001 CURR:SWIT:MODE CONT SAMP:COUN 2 READ?	
Change the current range to 1 V (no open circuit occurs when changing range). Make and read two measurements: CONF:CURR:DC 1 SAMP:COUN 2 READ?	
Typical Response: -5.28836573E-02,-5.01252821E-02	

- Applies only to the 34465A and 34470A.
- The DMM measures AC or DC current by measuring the voltage drop across one of several internal current shunts and then calculating the current. A different shunt is used depending on the selected current range. In CONTInuous mode (default), when changing current ranges, the DMM switches a low impedance in parallel with the first shunt before switching to the next shunt. This eliminates the momentary open circuit when changing ranges, but can take up to three times longer to change ranges than the FAST mode. In FAST mode, when a range change causes the DMM to switch from one shunt to another, a momentary open circuit occurs on the current input terminals. In most cases, this open circuit does not adversely affect your current measurements. However, if an open circuit adversely affects your circuitry or measurements, you can use CONTInuous mode.
- The switch mode applies to the 3A current terminals only. The 10A terminals are always effectively in FAST mode.
- This parameter is set to its default value after a Factory Reset (***RST**) or Instrument Preset (**SYSTem:PRESet**).

[SENSe:]DATA2 Subsystem

This subsystem retrieves or clears secondary measurements.

[SENSe:]DATA2?

Retrieves the secondary measurement.

Parameter	Typical Return
(none)	See example below
Configure DC voltage measurements using the 10 V range with 1 mV resolution. Select peak-to-peak as the secondary measurement. Make and retrieve measurements. CONF:VOLT:DC 10,0.001 VOLT:DC:SEC "PTP" READ?;DATA2? Typical Response: -1.84694879E-03;-2.23115575E-03,+5.98403324E-04,+2.82955909E-03 (<i>Data returned in this order: DCV reading, Min Peak, Max Peak, Peak-to-Peak</i>)	

- Returns 1, 2, or 3 values depending on the active secondary measurement. For example, ratio returns 2 values (main and sense terminal measurements); PTPeak returns 3 values (minimum peak, maximum peak, peak-to-peak).
- If there is currently no valid secondary measurement specified, the query returns "9.91000000E+37" (which is the IEEE488.2 definition of *Not a Number* - usually referred to as *NaN*).
- Configure secondary measurements using [SENSe:]CAPacitance:SECondary, [SENSe:]CURRent:AC:SECondary, [SENSe:]CURRent:DC:SECondary, [SENSe:]FREQuency:SECondary, [SENSe:]PERiod:SECondary, [SENSe:]TEMPerature:SECondary, [SENSe:]VOLTage:AC:SECondary, [SENSe:]VOLTage:DC:SECondary, or [SENSe:]VOLTage[:DC]:RATio:SECondary.
- Use READ? or INITiate to start the measurement. Use DATA2? to retrieve the secondary measurement.
- The instrument clears all measurements from reading memory when the measurement configuration changes, or when any of these commands are executed: INITiate, MEASure:<function>?, READ?, *RST, SYSTem:PRESet.

[SENSe:]DATA2:CLEar[:IMMediate]

Clears the latest result(s) of the secondary measurement. This is typically used to clear the accumulated history of the peak-to-peak function ([SENSe:]VOLT:[DC:]SECOndary "PTPeak" or [SENSe:]CURRent:[DC:]SECOndary "PTPeak").

Parameter	Typical Return
(none)	See example below
<p>Configure DC voltage measurements using the 10 V range with 1 mV resolution. Select peak-to-peak as the secondary measurement. Make and retrieve measurements.</p> <pre>CONF:VOLT:DC 10,0.001 VOLT:DC:SEC "PTP" READ?;DATA2?</pre> <p>Typical Response: -1.84694879E-03;-2.23115575E-03,+5.98403324E-04,+2.82955909E-03 (<i>Data returned in this order: DCV reading, Min Peak, Max Peak, Peak-to-Peak</i>)</p> <p>Later, clear peak-to-peak secondary measurement data. Make and retrieve measurements.</p> <pre>DATA2:CLE READ?;DATA2?</pre> <p>Typical Response: +1.29177114E-03;+6.07221096E-04,+3.43677658E-03,+2.82955548E-03 (<i>Data returned in this order: DCV reading, Min Peak, Max Peak, Peak-to-Peak</i>)</p>	

[SENSe:]{FREQuency|PERiod} Subsystem

This subsystem configures frequency and period measurements.

Command Summary

[SENSe:]{FREQuency|PERiod}:APERture

[SENSe:]{FREQuency|PERiod}:NULL[:STATe]

[SENSe:]{FREQuency|PERiod}:NULL:VALue

[SENSe:]{FREQuency|PERiod}:NULL:VALue:AUTO

[SENSe:]{FREQuency|PERiod}:RANGe:LOWer

[SENSe:]{FREQuency|PERiod}:TIMEout:AUTO

[SENSe:]{FREQuency|PERiod}:VOLTage:RANGe

[SENSe:]{FREQuency|PERiod}:VOLTage:RANGe:AUTO

[SENSe:]FREQuency:SECondary

[SENSe:]PERiod:SECondary

[SENSe:]{FREQuency|PERiod}:APERture {<seconds>|MIN|MAX|DEF}
 [SENSe:]{FREQuency|PERiod}:APERture? [{MIN|MAX|DEF}]

Sets the aperture time (gate time) for frequency and period measurements.

NOTE This parameter is shared between frequency and period measurements. Setting or querying the parameter with the FREQuency version of this command is identical to setting or querying it with the PERiod version.

Parameter	Typical Return
{1 ms 10 ms 100 ms 1 s}. Default: 100 ms.	+1.00000000E-01
Configure frequency measurements using a 1 s aperture, make a measurement, and return the result: CONF:FREQ FREQ:APER 1 READ?	

- The 1 ms aperture applies only to the 34465A and 34470A.
- The aperture for frequency and period measurements does not autorange.
- The measurement resolution is related to the aperture (gate time) as follows:

Resolution (34460A/61A)	Resolution (34465A/70A)	Aperture
Not Applicable	100 ppm × <range> (MAXimum)	1 ms
100 ppm × <range> (MAXimum)	10 ppm × <range> (DEFault)	10 ms
10 ppm × <range> (DEFault)	1 ppm × <range>	100 ms
1 ppm × <range> (MINimum)	0.1 ppm × <range> (MINimum)	1 s

- This parameter is set to its default value after a Factory Reset (*RST) or Instrument Preset (SYSTem:PRESet).

[SENSe:]{FREQuency|PERiod}:NULL[:STATe] {ON|1|OFF|0}
 [SENSe:]{FREQuency|PERiod}:NULL[:STATe]?

Enables or disables the null function for frequency and period measurements.

NOTE Unlike the SENSe:FREQuency and SENSe:PERiod range and aperture commands, this parameter is not shared between frequency and period measurements. The null parameters are independent for frequency and period measurements.

Parameter	Typical Return
{ON 1 OFF 0}. Default: OFF.	0 (OFF) or 1 (ON)
Configure frequency measurements, using the null function to subtract 1kHz from the measurements. Make and read two measurements: CONF:FREQ FREQ:NULL:STAT ON;VAL 1 kHz SAMP:COUN 2 READ? Typical Response: +1.04530000E+03,+1.04570000E+03	

- Enabling the scaling function also enables automatic null value selection ([SENSe:]{FREQuency|PERiod}:NULL:VALue:AUTO ON).
- To set a fixed null value, use: [SENSe:]{FREQuency|PERiod}:NULL:VALue.
- The instrument disables the null function after a Factory Reset (*RST), Instrument Preset (SYSTem:PRESet), or CONFigure function.

[SENSe:]{FREQuency|PERiod}:NULL:VALue {<value>|MIN|MAX|DEF}
 [SENSe:]{FREQuency|PERiod}:NULL:VALue? [{MIN|MAX|DEF}]

Stores a null value for frequency and period measurements.

NOTE Unlike the SENSe:FREQuency and SENSe:PERiod range and aperture commands, this parameter is not shared between frequency and period measurements. The null parameters are independent for frequency and period measurements.

Parameter	Typical Return
Frequency: -1.2E6 to +1.2E6. Default: 0. Period: -1.2 to +1.2 seconds. Default: 0.	+1.00000000E-02
Configure frequency measurements, using the null function to subtract 1kHz from the measurements. Make and read two measurements: CONF:FREQ FREQ:NULL:STAT ON;VAL 1 kHz SAMP:COUN 2 READ? Typical Response: +1.04530000E+03,+1.04570000E+03	

- Specifying a null value disables automatic null value selection ([SENSe:]{FREQuency|PERiod}:NULL:VALue:AUTO OFF).
- To use the null value, the null state must be on ([SENSe:]{FREQuency|PERiod}:NULL:STATe ON).
- This parameter is set to its default value after a Factory Reset (*RST), Instrument Preset (SYSTem:PRESet), or CONFigure function.

[SENSe:]{FREQuency|PERiod}:NULL:VALue:AUTO {ON|1|OFF|0}
 [SENSe:]{FREQuency|PERiod}:NULL:VALue:AUTO?

Enables or disables automatic null value selection for frequency and period measurements.

NOTE Unlike the SENSe:FREQuency and SENSe:PERiod range and aperture commands, this parameter is not shared between frequency and period measurements. The null parameters are independent for frequency and period measurements.

Parameter	Typical Return
{ON 1 OFF 0}. Default: OFF.	0 (OFF) or 1 (ON)
Configure frequency measurements, using the null function to subtract 1 kHz from them. Make and read two measurements: CONF:FREQ FREQ:NULL:STAT ON;VAL 1 kHz SAMP:COUN 2 READ? Typical Response: +1.04530000E+00,+1.04570000E+00 Make a second set of measurements using automatic null value selection: FREQ:NULL:VAL:AUTO ON READ? Typical Response: +0.00000000E+00,+0.01420000E+00	

- When automatic reference selection is ON, the first measurement made is used as the null value for all subsequent measurements. `[SENSe:]{FREQuency|PERiod}:NULL:VALue` is set to this value. Automatic null value selection will be disabled.
- When automatic null value selection is disabled (OFF), the null value is specified by: `[SENSe:]{FREQuency|PERiod}:NULL:VALue`.
- The instrument enables automatic null value selection when the null function is enabled (`[SENSe:]{FREQuency|PERiod}:NULL:STATe ON`).
- This parameter is set to its default value after a Factory Reset (`*RST`), Instrument Preset (`SYSTem:PRESet`), or CONFIgure function.

`[SENSe:]{FREQuency|PERiod}:RANGe:LOWer {<freq>|MIN|MAX|DEF}`
`[SENSe:]{FREQuency|PERiod}:RANGe:LOWer? [{MIN|MAX|DEF}]`

Sets the AC bandwidth used to detect the signal during frequency and period measurements.

NOTE This parameter is shared between frequency and period measurements. Setting or querying the parameter with the FREQuency version of this command is identical to setting or querying it with the PERiod version.

The instrument uses three different AC filters that enable you either to optimize low frequency accuracy or to achieve faster AC settling times following a change in input signal amplitude. The instrument selects the slow (3 Hz), medium (20 Hz) or fast (200 Hz) filter based on the cutoff frequency specified by this command. Specify the lowest frequency that you expect to encounter.

Parameter	Typical Return
{3 Hz 20 Hz 200 Hz}. Default: 20Hz.	+6.27530000E+03
Make and read a frequency measurement. Use the 3 Hz filter bandwidth:	
CONF:FREQ FREQ:RANG:LOW 3 READ?	

- If you enter the lowest expected frequency that you intend to encounter, the command will select the appropriate *<filter>*. For example, if you enter 15 Hz, the slow filter (3 Hz) is selected. If you enter 190 Hz, the medium filter (20 Hz) is selected to provide the appropriate low cutoff.
- Set the lowest frequency that you expect to encounter. Lower bandwidths result in longer settling delays, as shown:

Input Frequency	Default Settling Delay
3 Hz - 300 kHz (<i>Slow</i>)	1.66 s/measurement
20 Hz - 300 kHz (<i>Medium</i>)	0.25 s/measurement
200 Hz - 300 kHz (<i>Fast</i>)	0.025 s/measurement

- This parameter is set to its default value after a Factory Reset (`*RST`) or Instrument Preset (`SYSTem:PRESet`).

[SENSe:]{FREQuency|PERiod}:TIMeout:AUTO {ON|1|OFF|0}
 [SENSe:]{FREQuency|PERiod}:TIMeout:AUTO?

Controls how long the instrument waits before timing out on a frequency or period measurement when no signal is present.

Parameter	Typical Return
{ON 1 OFF 0}. Default: OFF.	0 (OFF) or 1 (ON)
Configure frequency measurements, using the null function to subtract 1kHz from the measurements. Enable the automatic timeout. Make and read two measurements: CONF:FREQ FREQ:NULL:STAT ON;VAL 1 kHz TIM:AUTO ON SAMP:COUN 2 READ? Typical Response: +1.04530000E+03,+1.04570000E+03	

- When set to OFF, the instrument waits 1 second before timing out. When set to ON, the wait time varies with AC filter bandwidth; for the faster bandwidths, the instrument waits a shorter time before timing out and returning 0.0. This is advantageous in manufacturing test systems where a DUT failure may result in no signal; in this case, the failure can be detected sooner, speeding up test throughput.
- This setting is non-volatile; it will not be changed by power cycling or ***RST** or **SYSTem:PRESet**.

[SENSe:]{FREQuency|PERiod}:VOLTage:RANGe {<range>|MIN|MAX|DEF}
 [SENSe:]{FREQuency|PERiod}:VOLTage:RANGe? [{MIN|MAX|DEF}]

Selects a fixed *voltage* range for frequency and period measurements.

NOTE This parameter is shared between frequency and period measurements. Setting or querying the parameter with the FREQuency version of this command is identical to setting or querying it with the PERiod version.

WARNING The maximum range parameter (MAX) is 1000 V. However, the SAFETY LIMIT on the front and rear HI/LO input terminals is 750 VAC (rms). The rms voltage is waveform dependent. A sine wave is limited to 750 VAC (rms), but a 1000 Vpk square wave is safe. Connection to AC mains power is further limited to CAT II (300 V). See **Safety and Regulatory Information** for more information on the safety features and the safe operation of this instrument.

Parameter	Typical Return
<range>: {100 mV 1 V 10 V 100 V 1000 V}. Default: 10V	+1.04530000E+03
Configures frequency measurements using the 10 VAC range. Make and read two measurements: CONF:FREQ FREQ:VOLT:RANG 10 SAMP:COUN 2 READ?	

- The input signal for frequency or period measurements has an AC *voltage* component. Use this command to select a fixed *voltage* range for frequency and period measurements. Use [SENSe:]{FREQuency|PERiod}:VOLTage:RANGe:AUTO to disable or enable voltage autoranging or use CONFIgure:~{FREQuency|PERiod} to select voltage autoranging by default.
- Selecting a fixed range ([SENSe:]<function>:RANGe) disables autoranging.
- If the input voltage is too large for the selected voltage range (manual ranging), the instrument displays the word Overload on the front panel and returns "9.9E37" from the remote interface. Autoranging can be enabled for the input voltage.
- This parameter is set to its default value after a Factory Reset (*RST) or Instrument Preset (SYSTem:PRESet).

[SENSe:]{FREQuency|PERiod}:VOLTage:RANGe:AUTO {OFF|ON|ONCE}
 [SENSe:]{FREQuency|PERiod}:VOLTage:RANGe:AUTO?

Disables or enables *voltage* autoranging for frequency and period measurements. Autoranging is convenient because it automatically selects the range for each measurement based on the input signal.

Specifying ONCE performs an immediate autorange and then turns autoranging off.

NOTE This parameter is shared between frequency and period measurements. Setting or querying the parameter with the FREQuency version of this command is identical to setting or querying it with the PERiod version.

WARNING The maximum range parameter (MAX) is 1000 V. However, the SAFETY LIMIT on the front and rear HI/LO input terminals is 750 VAC (rms). The rms voltage is waveform dependent. A sine wave is limited to 750 VAC (rms), but a 1000 Vpk square wave is safe. Connection to AC mains power is further limited to CAT II (300 V). See **Safety and Regulatory Information** for more information on the safety features and the safe operation of this instrument.

Parameter	Typical Return
{OFF ON ONCE}. Default: ON.	0 (OFF) or 1 (ON)
Configure frequency measurements and perform an immediate AC voltage autorange. Make and read two measurements: CONF:FREQ FREQ:VOLT:RANG:AUTO ONCE SAMP:COUN 2 READ? Typical Response: +1.04530000E+03,+1.04570000E+03	

- The input signal for frequency or period measurements has an AC *voltage* component. Use this command to disable or enable voltage autoranging or use **CONFigure:}{FREQuency|PERiod}** to select voltage autoranging by default. Use **[SENSe:]{FREQuency|PERiod}:VOLTage:RANGe** to select a fixed voltage range for frequency and period measurements.
- Autoranging goes down a range at less than 10% of range and up a range at greater than 120% of range.
- Selecting a fixed range ([SENSe:]<function>:RANGe) disables autoranging.
- This parameter is set to its default value after a Factory Reset (***RST**) or Instrument Preset (**SYSTem:PRESet**).

[SENSe:]FREQuency:SECOndary {"OFF"|"CALCulate:DATA"|"PERiod"|"VOLTage:AC"}
 [SENSe:]FREQuency:SECOndary?

Selects the secondary measurement function for frequency measurements.

Parameter	Typical Return
{"OFF" "CALCulate:DATA" "PERiod" "VOLTage:AC"}, default "OFF"	"CALC:DATA"
Configure frequency measurements, select period as the secondary measurement, make and retrieve measurements. CONF:FREQ MAX, MAX FREQ:SEC "PERiod" READ?;DATA2? Typical Response: +1.22230020E+02;+8.18129619E-03	

- "CALCulate:DATA" - (Applies only to the 34465A and 34470A.) The measurement value before any math operations are done (including NULL).
- "PERiod" - The period measurement of the input signal.
- "VOLTage:AC" - The AC voltage measurement of the input signal.
- This parameter is set to its default value after a Factory Reset (***RST**) or Instrument Preset (**SYSTem:PRESet**).

[SENSe:]PERiod:SECOndary {"OFF"|"CALCulate:DATA"|"FREQuency"|"VOLTage:AC"}
 [SENSe:]PERiod:SECOndary?

Selects the secondary measurement function for period measurements.

Parameter	Typical Return
{"OFF" "CALCulate:DATA" "FREQuency" "VOLTage:AC"}, default "OFF"	"CALC:DATA"
Configure period measurements, select frequency as the secondary measurement, make and retrieve measurements. CONF:PER MAX, MAX PER:SEC "FREQ" READ?;DATA2? Typical Response: +8.90363477E-03;+1.12313682E+02	

- "CALCulate:DATA" - (Applies only to the 34465A and 34470A.) The measurement value before any math operations are done (including NULL).
- "FREQuency" - The frequency measurement of the input signal.
- "VOLTage:AC" - The AC voltage measurement of the input signal.
- This parameter is set to its default value after a Factory Reset (***RST**) or Instrument Preset (**SYSTem:PRESet**).

[SENSe:]{RESistance|FRESistance} Subsystem

This subsystem configures two- and four-wire resistance measurements.

Command Summary

[SENSe:]{RESistance|FRESistance}:APERture

[SENSe:]{RESistance|FRESistance}:APERture:ENABled

[SENSe:]{RESistance|FRESistance}:NPLC

[SENSe:]{RESistance|FRESistance}:NULL[:STATe]

[SENSe:]{RESistance|FRESistance}:NULL:VALue

[SENSe:]{RESistance|FRESistance}:NULL:VALue:AUTO

[SENSe:]{RESistance|FRESistance}:OCOMPensated

[SENSe:]{RESistance|FRESistance}:POWER:LIMit[:STATe]

[SENSe:]{RESistance|FRESistance}:RANGe

[SENSe:]{RESistance|FRESistance}:RANGe:AUTO

[SENSe:]{RESistance|FRESistance}:RESolution

[SENSe:]{FRESistance|RESistance}:SECOndary

[SENSe:]RESistance:ZERO:AUTO

[SENSe:]{RESistance|FRESistance}:APERture {<seconds>|MIN|MAX|DEF}
 [SENSe:]{RESistance|FRESistance}:APERture? [{MIN|MAX|DEF}]

Specifies the integration time in seconds (called *aperture time*) for resistance measurements.

NOTE

Use this command for precise control of the DMM's integration time. Use NPLC (see [SENSe:]FRESistance:NPLC) for better power-line noise rejection characteristics (NPLC > 1)..

This parameter is common to 2-wire and 4-wire resistance measurements. Using the FRESistance version of this command or query is identical to using the RESistance version.

Parameter	Typical Return
(Without the DIG option) 200 μ s to 1 s (2 μ s resolution), default: 100 ms. (With the DIG option) 20 μ s to 1 s (2 μ s resolution), default: 100 ms.	+1.00000000E-01
Enable aperture, set aperture time to 300 milliseconds: RES:APER:ENAB ON RES:APER 300E-03 or FRES:APER:ENAB ON FRES:APER 300E-03	

- Applies only to the 34465A and 34470A.
- Affects both 2-wire and 4-wire resistance measurements.
- Both the [SENSe:]<function>:NPLC and [SENSe:]<function>:APERture commands control the instrument's integration time. When using both commands (not recommended), whichever command is sent last will override the other command and set the integration time. Sending the [SENSe:]<function>:APERture command sets the [SENSe:]<function>:APERture:ENABLEd command to 1 (ON); sending [SENSe:]<function>:NPLC sets it to 0 (OFF).
- This parameter is set to its default value after a Factory Reset (*RST) or Instrument Preset (SYSTem:PRESet).

[SENSe:]{RESistance|FRESistance}:APERture:ENABLEd {ON|1|OFF|0}
 [SENSe:]{RESistance|FRESistance}:APERture:ENABLEd?

Enables the setting of integration time in seconds (called *aperture time*) for resistance measurements. If aperture time mode is disabled (default), the integration time is set in PLC (power-line cycles).

NOTE This parameter is common to 2-wire and 4-wire resistance measurements. Using the FRESistance version of this command or query is identical to using the RESistance version.

Parameter	Typical Return
{ON 1 OFF 0}. Default: OFF.	0 (OFF) or 1 (ON)
Enable aperture, set aperture time to 300 ms: RES:APER:ENAB ON RES:APER 300E-03 <i>or</i> FRES:APER:ENAB ON FRES:APER 300E-03	

- Applies only to the 34465A and 34470A.
- This query determines whether the aperture used for both 2-wire and 4-wire resistance measurements is enabled.
- The **CONFigure:FRESistance**, **MEASure:FRESistance?**, **[SENSe:]{RESistance|FRESistance}:NPLC**, and **[SENSe:]{RESistance|FRESistance}:RESolution** commands disable the aperture time mode, and select an integration time in number of power line cycles.
- This parameter is set to its default value after a Factory Reset (***RST**) or Instrument Preset (**SYSTem:PRESet**).

[SENSe:]{RESistance|FRESistance}:NPLC {<PLC>|MIN|MAX|DEF}
[SENSe:]{RESistance|FRESistance}:NPLC? [{MIN|MAX|DEF}]

Sets the integration time in number of power line cycles (PLC) for all resistance measurements. Integration time is the period that the instrument's analog-to-digital (A/D) converter samples the input signal for a measurement. A longer integration time gives better measurement resolution but slower measurement speed.

NOTE This parameter is common to 2-wire and 4-wire resistance measurements. Using the FRESistance version of this command or query is identical to using the RESistance version.

Parameter	Typical Return
0.02, 0.2, 1, 10, 100. Default: 10 (34460A/61A) 0.02, 0.06, 0.2, 1, 10, 100. Default: 10 (34465A/70A without DIG option) 0.001, 0.002, 0.006, 0.02, 0.06, .2, 1, 10, 100. Default: 10 (34465A/70A with DIG option) See Range , Resolution and NPLC for more information.	+1.00000000E+01
Configure 4-wire resistance measurements using a 10 PLC integration time. Then make and read one measurement: CONF:FRES FRES:NPLC 10 READ? Typical Response: +6.27530000E+01	

- Selecting an integration time in power line cycles overrides an aperture set with the **[SENSe:]{RESistance|FRESistance}:APERture** command.
- Only integration times of 1, 10, or 100 PLC provide normal mode (line frequency noise) rejection.
- Setting the integration time also sets the measurement resolution. [Resolution Table](#) shows the relationship between integration time and resolution.
- This parameter is set to its default value after a Factory Reset (***RST**) or Instrument Preset (**SYSTem:PRESet**).

[SENSe:]{RESistance|FRESistance}:NULL[:STATe] {ON|1|OFF|0}
 [SENSe:]{RESistance|FRESistance}:NULL[:STATe]?

Enables or disables the null function for all resistance measurements.

NOTE This parameter is common to 2-wire and 4-wire resistance measurements. Using the FRESistance version of this command or query is identical to using the RESistance version.

Parameter	Typical Return
{ON 1 OFF 0}. Default: OFF.	0 (OFF) or 1 (ON)
Configure 2-wire resistance measurements, using the null function to remove 100 mΩ of wiring resistance. Make and read two measurements: CONF:RES RES:NULL:STAT ON;VAL .1 SAMP:COUN 2 READ? Typical Response: +1.04530000E+02,+1.04570000E+02	

- Enabling the scaling function also enables automatic null value selection (SENSe: {RESistance|FRESistance}:NULL:VALue:AUTO ON).
- To set a fixed null value, use: [SENSe:]{RESistance|FRESistance}:NULL:VALue.
- The instrument disables the null function after a Factory Reset (*RST), Instrument Preset (SYSTem:PRESet), or CONFigure function.

[SENSe:]{RESistance|FRESistance}:NULL:VALue {<value>|MIN|MAX|DEF}
[SENSe:]{RESistance|FRESistance}:NULL:VALue? [{MIN|MAX|DEF}]

Stores a null value for all resistance measurements.

NOTE This parameter is common to 2-wire and 4-wire resistance measurements. Using the FRESistance version of this command or query is identical to using the RESistance version.

Parameter	Typical Return
-120 MΩ to +120 MΩ. Default: 0. (34460A/61A) -1.2 GΩ to +1.2 GΩ. Default: 0. (34465A/70A)	+1.04530000E+02
Configure 2-wire resistance measurements, using the null function to remove 100 mΩ of wiring resistance. Make and read two measurements: CONF:RES RES:NULL:STAT ON;VAL .1 SAMP:COUN 2 READ? Typical Response: +1.04530000E+02,+1.04570000E+02	

- Specifying a null value disables automatic null value selection (**[SENSe:]{RESistance|FRESistance}:NULL:VALue:AUTO OFF**).
- To use the null value, the null state must be on (**[SENSe:]{RESistance|FRESistance}:NULL:STATe ON**).
- This parameter is set to its default value after a Factory Reset (***RST**), Instrument Preset (**SYSTem:PRESet**), or CONFigure function.

[SENSe:]{RESistance|FRESistance}:NULL:VALue:AUTO {ON|1|OFF|0}
[SENSe:]{RESistance|FRESistance}:NULL:VALue:AUTO?

Enables or disables automatic null value selection for all resistance measurements.

NOTE This parameter is common to 2-wire and 4-wire resistance measurements. Using the FRESistance version of this command or query is identical to using the RESistance version.

Parameter	Typical Return
{ON 1 OFF 0}. Default: OFF.	0 (OFF) or 1 (ON)
Configure 2-wire resistance measurements, using the null function to remove 100 mΩ of wiring resistance. Make and read two measurements: CONF:RES RES:NULL:STAT ON;VAL .1 SAMP:COUN 2 READ? Typical Response: +1.04530000E+02,+1.04570000E+02 Make a second set of measurements using automatic null value selection: RES:NULL:VAL:AUTO ON READ? Typical Response: +0.00000000E+00,+0.01420000E+00	

- When automatic reference selection is ON, the first measurement made is used as the null value for all subsequent measurements. **[SENSe:]{RESistance|FRESistance}:NULL:VALue** is set to this value. Automatic null value selection will be disabled.
- When automatic null value selection is disabled (OFF), the null value is specified by: **[SENSe:]{RESistance|FRESistance}:NULL:VALue**.
- The instrument enables automatic null value selection when the null function is enabled (**[SENSe:]{RESistance|FRESistance}:NULL:STATe ON**).
- This parameter is set to its default value after a Factory Reset (***RST**), Instrument Preset (**SYSTem:PRESet**), or CONFigure function.

[SENSe:]{RESistance|FRESistance}:OCOMpensated {OFF|ON}
[SENSe:]{RESistance|FRESistance}:OCOMpensated?

Enables or disables offset compensation. Offset compensation removes the effects of small dc voltages in the circuit being measured. The technique involves taking the difference between two resistance measurements, one with the current source set to the normal value, and one with the current source set to a lower value. Enabling Offset Compensation approximately doubles the reading time.

NOTE This parameter is common to 2-wire and 4-wire resistance measurements. Using the FRESistance version of this command or query is identical to using the RESistance version.

Parameter	Typical Return
{ON 1 OFF 0}. Default: OFF.	0 (OFF) or 1 (ON)
Configure low-power 2-wire resistance measurements. Enable offset compensation. Make and read two measurements: RES:POW:LIM ON RES:OCOM ON SAMP:COUN 2 READ? Typical Response: +4.05451008E-03,+4.97391062E-03	

- Applies only to the 34465A and 34470A.
- Affects both 2-wire and 4-wire resistance measurements.
- Applies only to resistance measurements on the 100Ω, 1 kΩ, 10 kΩ and 100 kΩ ranges.
- This parameter is set to its default value after a Factory Reset (***RST**) or Instrument Preset (**SYSTem:PRESet**).

[SENSe:][RESistance|FRESistance]:POWer:LIMit[:STATe] {OFF|ON}
 [SENSe:][RESistance|FRESistance]:POWer:LIMit[:STATe]?

Enables or disables low-power resistance measurements (either 2- or 4-wire).

NOTE This parameter is common to 2-wire and 4-wire resistance measurements. Using the FRESistance version of this command or query is identical to using the RESistance version.

Parameter	Typical Return
{ON 1 OFF 0}. Default: OFF.	0 (OFF) or 1 (ON)
Configure 4-wire resistance measurements using a 10 PLC integration time. Enable low-power 4-wire resistance measurements. Then make and read one measurement: CONF:FRES FRES:NPLC 10 FRES:POW:LIM ON READ? Typical Response: +6.27530000E+01	

- Applies only to the 34465A and 34470A.
- This parameter is set to its default value after a Factory Reset (*RST) or Instrument Preset (SYSTem:PRESet).
- Low-power resistance measurements apply to the 100Ω through 100kΩ ranges only. The 1 MΩ through 1 GΩ ranges source the same current regardless of the low-power setting.

[SENSe:][RESistance|FRESistance]:RANGe {<range>|MIN|MAX|DEF}
 [SENSe:][RESistance|FRESistance]:RANGe? [{MIN|MAX|DEF}]

Selects a fixed measurement range for all resistance measurements.

NOTE This parameter is common to 2-wire and 4-wire resistance measurements. Using the FRESistance version of this command or query is identical to using the RESistance version.

Parameter	Typical Return
{100 Ω 1 kΩ 10 kΩ 100 kΩ 1 MΩ 10 MΩ 100 MΩ 1 GΩ}. Default: 1 kΩ.	+1.00000000E+03
Configure 2-wire resistance measurements using the 10 kΩ range. Then make and read one measurement: CONF:RES RES:RANG 10E3 READ? Typical Response: +6.27530000E+03	

- The 1 GΩ range applies only to the 34465A and 34470A.
- Selecting a fixed range ([SENSe:]<function>:RANGe) disables autoranging.
- If the input signal is greater than can be measured on the specified manual range, the instrument displays the word *Overload* on front panel and returns "9.9E37" from the remote interface.

See Also

[SENSe:]{RESistance|FRESistance}:RANGe:AUTO

[SENSe:]{RESistance|FRESistance}:RANGe:AUTO {OFF|ON|ONCE}

[SENSe:]{RESistance|FRESistance}:RANGe:AUTO?

Disables or enables autoranging for all resistance measurements. Autoranging is convenient because it automatically selects the range for each measurement based on the input signal. Specifying ONCE performs an immediate autorange and then turns autoranging off.

NOTE This parameter is common to 2-wire and 4-wire resistance measurements. Using the FRESistance version of this command or query is identical to using the RESistance version.

Parameter	Typical Return
{ON 1 OFF 0}. Default: ON.	0 (OFF) or 1 (ON)
Configure 2-wire resistance measurements and perform an immediate autorange. Make and read two measurements: CONF:RES RES:RANG:AUTO ONCE SAMP:COUN 2 READ? Typical Response: +1.04530000E+03,+1.04570000E+03	

- Autoranging goes down a range at less than 10% of range and up a range at greater than 120% of range.
- With autoranging enabled, the instrument selects the range based on the input signal.
- Selecting a fixed range ([SENSe:]<function>:RANGe) disables autoranging.
- This parameter is set to its default value after a Factory Reset (***RST**) or Instrument Preset (**SYSTem:PRESet**).

[SENSe:]{RESistance|FRESistance}:RESolution {<resolution>|MIN|MAX|DEF}
 [SENSe:]{RESistance|FRESistance}:RESolution? [{MIN|MAX|DEF}]

Selects the measurement resolution for all resistance measurements. Specify the resolution in the same units as the selected measurement function, not in number of digits.

NOTE This parameter is common to 2-wire and 4-wire resistance measurements. Using the FRESistance version of this command or query is identical to using the RESistance version.

Parameter	Typical Return
<resolution>: See Resolution Table or Range, Resolution and NPLC . The default is equivalent to 10 PLC. Specify <resolution> in the measurement's units (V, A, Hz, Ω, and so on).	+3.00000000E+00
Configure 2-wire resistance measurements with a 3 Ω resolution. Then make and read one measurement: CONF:RES 1E6 RES:RES 3 READ? Typical Response: +6.27531500E+05	

- You can specify MIN (best resolution) or MAX (worst resolution) instead of <resolution>.
- To achieve normal mode (line frequency noise) rejection, use a resolution that corresponds to an integration time that is an integral number of power line cycles.
- This parameter is set to its default value after a Factory Reset (*RST) or Instrument Preset (SYSTem:PRESet).

See Also

[SENSe:]{RESistance|FRESistance}:NPLC

[SENSe:]{FREStance|RESistance}:SECOndary {"OFF"|"CALCulate:DATA"}
 [SENSe:]{FREStance|RESistance}:SECOndary?

Selects the secondary measurement function for all resistance measurements.

Parameter	Typical Return
{"OFF" "CALCulate:DATA"}, default "OFF"	"CALC:DATA"
Configure resistance and secondary measurements. Make resistance measurement and retrieve secondary measurement. CONF:RES AUTO,MAX RES:SEC "CALC:DATA" READ?;DATA2? Typical Response: +3.01566373E-10;,+9.91000000E+3	

- "CALCulate:DATA" - (Applies only to the 34465A and 34470A.) The measurement value before any math operations are done (including NULL).
- Use **READ?** or **INITiate** to start the measurement. Use **[SENSe:]DATA2?** to retrieve the secondary measurement.
- This parameter is set to its default value after a Factory Reset (***RST**) or Instrument Preset (**SYSTem:PRESet**).

[SENSe:]RESistance:ZERO:AUTO {OFF|ON|ONCE}

[SENSe:]RESistance:ZERO:AUTO?

Disables or enables the autozero mode for 2-wire resistance measurements.

- **ON (default):** the DMM internally measures the offset following each measurement. It then subtracts that measurement from the preceding reading. This prevents offset voltages present on the DMM's input circuitry from affecting measurement accuracy.
- **OFF:** the instrument uses the last measured zero measurement and subtracts it from each measurement. It takes a new zero measurement each time you change the function, range or integration time.
- **ONCE:** the instrument takes one zero measurement and sets autozero OFF. The zero measurement taken is used for all subsequent measurements until the next change to the function, range or integration time. If the specified integration time is less than 1 PLC, the zero measurement is taken at 1 PLC to optimize noise rejection. Subsequent measurements are taken at the specified fast (< 1 PLC) integration time.

Parameter	Typical Return
{OFF ON ONCE}	0 (OFF) or 1 (ON)
Configure 2-wire resistance measurements and perform an immediate autozero. Make and read two measurements: CONF:RES 1E4 RES:ZERO:AUTO ONCE SAMP:COUN 2 READ? Typical Response: +1.04530000E+03,+1.04570000E+03	

- Does not affect 4-wire resistance measurements, which are always made with autozero ON.
- The autozero mode is set indirectly when you set the resolution and integration time using **CONFigure:{RESistance|FRESistance}** or **MEASure:{RESistance|FRESistance}?**. Autozero is automatically turned OFF when you select an integration time less than 1 PLC with these commands.
- This parameter is set to its default value after a Factory Reset (***RST**) or Instrument Preset (**SYSTem:PRESet**).

[SENSe:]TEMPerature Subsystem

This subsystem configures temperature measurements.

Command Summary

[SENSe:]TEMPerature:APERture

[SENSe:]TEMPerature:APERture:ENABLEd

[SENSe:]TEMPerature:NPLC

[SENSe:]TEMPerature:NULL[:STATe]

[SENSe:]TEMPerature:NULL:VALue

[SENSe:]TEMPerature:NULL:VALue:AUTO

[SENSe:]TEMPerature:SECondary

[SENSe:]TEMPerature:TRANsdUCer:{FRTD|RTD}:OCOMpensated

[SENSe:]TEMPerature:TRANsdUCer:{FRTD|RTD}:POWER:LIMit[:STATe]

[SENSe:]TEMPerature:TRANsdUCer:{FRTD|RTD}:RESistance[:REFerence]

[SENSe:]TEMPerature:TRANsdUCer:{FThermistor|THERmistor}:POWER:LIMit[:STATe]

[SENSe:]TEMPerature:TRANsdUCer:{FThermistor|THERmistor}:TYPE

[SENSe:]TEMPerature:TRANsdUCer:TCouple:CHECK

[SENSe:]TEMPerature:TRANsdUCer:TCouple:RJUNction

[SENSe:]TEMPerature:TRANsdUCer:TCouple:RJUNction:OFFSet:ADJust

[SENSe:]TEMPerature:TRANsdUCer:TCouple:RJUNction:TYPE

[SENSe:]TEMPerature:TRANsdUCer:TCouple:TYPE

[SENSe:]TEMPerature:TRANsdUCer:TYPE

[SENSe:]TEMPerature:ZERO:AUTO

[SENSe:]TEMPerature:APERture {<seconds>|MIN|MAX|DEF}
 [SENSe:]TEMPerature:APERture? [{MIN|MAX|DEF}]

Specifies the integration time in seconds (called *aperture time*) for temperature measurements.

NOTE Use this command for precise control of the DMM's integration time. Use NPLC (see [SENSe:]TEMPerature:NPLC) for better power-line noise rejection characteristics (NPLC > 1).

Parameter	Typical Return
(Without the DIG option) 200 μs to 1 s (2 μs resolution), default: 100 ms. (With the DIG option) 20 μs to 1 s (2 μs resolution), default: 100 ms.	+1.00000000E-01
Enable aperture, set the aperture time to 300 ms: TEMP:APER:ENAB ON TEMP:APER 300E-03	

- Applies only to the 34465A and 34470A.
- Both the [SENSe:]<function>:NPLC and [SENSe:]<function>:APERture commands control the instrument's integration time. When using both commands (not recommended), whichever command is sent last will override the other command and set the integration time. Sending the [SENSe:]<function>:APERture command sets the [SENSe:]<function>:APERture:ENABLEd command to 1 (ON); sending [SENSe:]<function>:NPLC sets it to 0 (OFF).
- This parameter is set to its default value after a Factory Reset (*RST) or Instrument Preset (SYSTem:PRESet).

[SENSe:]TEMPerature:APERture:ENABLEd {ON|1|OFF|0}
 [SENSe:]TEMPerature:APERture:ENABLEd?

Enables the setting of integration time in seconds (called *aperture time*) for temperature measurements. If aperture time mode is disabled (default), the integration time is set in PLC (power-line cycles).

Parameter	Typical Return
{ON 1 OFF 0}. Default: OFF.	0 (OFF) or 1 (ON)
Enable aperture time mode, set the aperture time to 300 ms: TEMP:APER:ENAB ON TEMP:APER 300E-03	

- Applies only to the 34465A and 34470A.
- The CONFigure:TEMPerature, MEASure:TEMPerature?, and [SENSe:]TEMPerature:NPLC commands disable the aperture time mode, and select an integration time in number of power line cycles.
- This parameter is set to its default value after a Factory Reset (*RST) or Instrument Preset (SYSTem:PRESet).

[SENSe:]TEMPerature:NPLC {<PLC>|MIN|MAX|DEF}
 [SENSe:]TEMPerature:NPLC? [{MIN|MAX|DEF}]

Sets the integration time in number of power line cycles (PLC) for temperature measurements. Integration time is the period that the instrument's analog-to-digital (A/D) converter samples the input signal for a measurement. A longer integration time gives better measurement resolution but slower measurement speed.

Parameter	Typical Return
0.02, 0.2, 1, 10, 100. Default: 10 (34460A/61A) 0.02, 0.06, 0.2, 1, 10, 100. Default: 10 (34465A/70A without DIG option) 0.001, 0.002, 0.006, 0.02, 0.06, .2, 1, 10, 100. Default: 10 (34465A/70A with DIG option) See Range, Resolution and NPLC for more information.	+1.00000000E+01
Configure 4-wire RTD measurements using a 10 PLC integration time. Then make and read one measurement: CONF:TEMP FRTD TEMP:NPLC 10 READ? Typical Response: +6.27530000E+01	

- Selecting an integration time in power line cycles overrides an aperture set with the [SENSe:]TEMPerature:APERture command.
- Only integration times of 1, 10, or 100 PLC provide normal mode (line frequency noise) rejection.
- Setting the integration time also sets the measurement resolution. [Resolution Table](#) shows the relationship between integration time and resolution.
- This parameter is set to its default value after a Factory Reset (*RST) or Instrument Preset (SYSTem:PRESet).

[SENSe:]TEMPerature:NULL[:STATe] {ON|1|OFF|0}
 [SENSe:]TEMPerature:NULL[:STATe]?

Enables or disables the null function for temperature measurements.

Parameter	Typical Return
{ON 1 OFF 0}. Default: OFF.	0 (OFF) or 1 (ON)
Configure 4-wire RTD measurements, using the null function to subtract 25°. Make and read two measurements: CONF:TEMP RTD TEMP:NULL:STAT ON VAL 25;SAMP:COUN 2 READ? Typical Response: +1.04530000E+00,+1.04570000E+00	

- Enabling the scaling function also enables automatic null value selection ([SENSe:]TEMPerature:NULL:VALue:AUTO ON).
- To set a fixed null value, use: [SENSe:]TEMPerature:NULL:VALue.
- The instrument disables the null function after a Factory Reset (*RST), Instrument Preset (SYSTem:PRESet), or CONFigure function.

[SENSe:]TEMPerature:NULL:VALue {<value>|MIN|MAX|DEF}
 [SENSe:]TEMPerature:NULL:VALue? [{MIN|MAX|DEF}]

Stores a null value for temperature measurements.

Parameter	Typical Return
-1.0E15 to +1.0E15. Default: 0.	+2.50000000E+01
Configure 4-wire RTD measurements, using the null function to subtract 25°. Make and read two measurements: CONF:TEMP RTD TEMP:NULL:STAT ON VAL 25;SAMP:COUN 2 READ? Typical Response: +1.04530000E+00,+1.04570000E+00	

- Specifying a null value disables automatic null value selection ([SENSe:]TEMPerature:NULL:VALue:AUTO OFF).
- To use the null value, the null state must be on ([SENSe:]TEMPerature:NULL:STATe ON).
- This parameter is set to its default value after a Factory Reset (*RST), Instrument Preset (SYSTem:PRESet), or CONFigure function.

[SENSe:]TEMPerature:NULL:VALue:AUTO {ON|1|OFF|0}

[SENSe:]TEMPerature:NULL:VALue:AUTO?

Enables or disables automatic null value selection for temperature measurements.

Parameter	Typical Return
{ON 1 OFF 0}. Default: OFF.	0 (OFF) or 1 (ON)
Configure temperature measurements, using the null function to subtract 25° from them. Make and read two measurements: CONF:TEMP RTD TEMP:NULL:STAT ON;VAL 25> SAMP:COUN 2 READ? Typical Response: +1.04530000E+00,+1.04570000E+00 Make a second set of measurements using automatic null value selection: TEMP:NULL:VAL:AUTO ON READ? Typical Response: +0.00000000E+00,+0.01420000E+00	

- When automatic reference selection is ON, the first measurement made is used as the null value for all subsequent measurements. [SENSe:]TEMPerature:NULL:VALue is set to this value. Automatic null value selection will be disabled.
- When automatic null value selection is disabled (OFF), the null value is specified by: [SENSe:]TEMPerature:NULL:VALue.
- The instrument enables automatic null value selection when the null function is enabled ([SENSe:]TEMPerature:NULL:STATe ON).
- This parameter is set to its default value after a Factory Reset (*RST), Instrument Preset (SYSTem:PRESet), or CONFigure function.

[SENSe:]TEMPerature:SECondary {"OFF"|"CALCulate:DATA"|"SENSe:DATA"}
 [SENSe:]TEMPerature:SECondary?

Selects the secondary measurement function for temperature measurements.

Parameter	Typical Return
{"OFF" "CALCulate:DATA" "SENSe:DATA"}, default "OFF"	"CALC:DATA"
Configure a 4-wire RTD measurement. Select the raw sensor value (ohms in this example) as the secondary measurement. Make and retrieve measurements. CONF:TEMP FRTD,85 TEMP:SEC "SENS:DATA" READ?;DATA2? Typical Response: -6.95327319E-01; +9.97282173E+01	

- "CALCulate:DATA" - (Applies only to the 34465A and 34470A.) The measurement value before any math operations are done (including NULL).
- "SENSe:DATA" is the raw sensor value; resistance for thermistor/RTD, voltage and reference temperature for thermocouple (thermocouple measurements apply to the 34465A and 34470A only).
- Use **READ?** or **INITiate** to start the measurement.
- This parameter is set to its default value after a Factory Reset (***RST**) or Instrument Preset (**SYSTem:PRESet**).

[SENSe:]TEMPerature:TRANsducer:{FRTD|RTD}:OCOMPensated {ON|1|OFF|0}
 [SENSe:]TEMPerature:TRANsducer:{FRTD|RTD}:OCOMPensated?

Enables or disables offset compensation for 2-wire and 4-wire RTD measurements.

Offset compensation removes the effects of small dc voltages in the circuit being measured. The technique involves taking the difference between two resistance measurements, one with the current source set to the normal value, and one with the current source set to a lower value.

NOTE This parameter is common to 2-wire and 4-wire resistance measurements. Using the FRTD version of this command or query is identical to using the RTD version.

Parameter	Typical Return
{ON 1 OFF 0}. Default: OFF.	0 (OFF) or 1 (ON)
Configure offset-compensated 2-wire RTD measurements. Make and read two measurements: CONF:TEMP RTD TEMP:TRANS:RTD:POW:LIM ON TEMP:TRANS:RTD:OCOM ON SAMP:COUN 2 READ? Typical Response: +1.05451008E+01,+1.07391062E+01	

- Applies only to the 34465A and 34470A.
- Affects both 2-wire and 4-wire resistance measurements.
- This parameter is set to its default value after a Factory Reset (*RST) or Instrument Preset (SYSTem:PRESet).

[SENSe:]TEMPerature:TRANsducer:{FRTD|RTD}:POWer:LIMit[:STATe] {ON|1|OFF|0}
 [SENSe:]TEMPerature:TRANsducer:{FRTD|RTD}:POWer:LIMit[:STATe]?

Enables or disables low-power, 2-wire or 4-wire, RTD measurements.

NOTE This parameter is common to 2-wire and 4-wire RTD measurements. Using the FRTD version of this command or query is identical to using the RTD version.

Parameter	Typical Return
{ON 1 OFF 0}. Default: OFF.	0 (OFF) or 1 (ON)
Configure offset-compensated 2-wire RTD measurements. Make and read two measurements: CONF:TEMP RTD TEMP:TRANS:RTD:POW:LIM ON TEMP:TRANS:RTD:OCOM ON SAMP:COUN 2 READ? Typical Response: +1.05451008E+01,+1.07391062E+01	

- Applies only to the 34465A and 34470A.
- This parameter is set to its default value after a Factory Reset (*RST) or Instrument Preset (SYSTem:PRESet).

[SENSe:]TEMPerature:TRANsducer:{FRTD|RTD}:RESistance[:REFerence] {<reference>|MIN|MAX|DEF}
 [SENSe:]TEMPerature:TRANsducer:{FRTD|RTD}:RESistance[:REFerence]? [{MIN|MAX|DEF}]

Selects the nominal resistance (R_0) for 2-wire and 4-wire RTD measurements. R_0 is the nominal resistance of an RTD at 0 °C.

Parameter	Typical Return
34460A/61A: 80 Ω to 120 Ω. Default: 100 Ω. 34465A/70A: 49 Ω to 2100 Ω. Default: 100 Ω.	+1.00100000E+02
Configure 4-wire RTD measurements using an RTD with an R_0 of 100.1 Ω. Make and read two measurements: CONF:TEMP FRTD TEMP:TRAN:FRTD:RES 100.1 SAMP:COUN 2 READ? Typical Response: +1.04530000E+02,+1.04570000E+02	

- This parameter is set to its default value after a Factory Reset (*RST) or Instrument Preset (SYSTem:PRESet).

[SENSe:]TEMPerature:TRANsducer:{FTHermistor|THERmistor}:POWer:LIMit[:STATe] {ON|1|OFF|0}
 [SENSe:]TEMPerature:TRANsducer:{FTHermistor|THERmistor}:POWer:LIMit[:STATe]?

Enables or disables low-power thermistor measurements (either 2- or 4-wire).

Parameter	Typical Return
{ON 1 OFF 0}. Default: OFF.	0 (OFF) or 1 (ON)
Configure 4-wire thermistor measurements. Enable low-power thermistor measurements. Make and read two measurements: CONF:TEMP FTH TEMP:TRAN:FTH:TYPE 5000 TEMP:TRAN:FTH:POW:LIM ON SAMP:COUN 2 READ? Typical Response: +1.04530000E+02,+1.04570000E+02	

- Applies only to the 34465A and 34470A.
- Only integration times of 1, 10, or 100 PLC provide normal mode (line frequency noise) rejection.
- Setting the integration time also sets the measurement resolution. **Resolution Table** shows the relationship between integration time and resolution.
- This parameter is set to its default value after a Factory Reset (***RST**) or Instrument Preset (**SYSTem:PRESet**).

[SENSe:]TEMPerature:TRANsducer:TYPE {FRTD|RTD|FTHermistor|THERmistor|TCouple}
 [SENSe:]TEMPerature:TRANsducer:TYPE?

Selects the transducer probe type to use for temperature measurements. The supported probes are 2-wire and 4-wire RTDs, 2-wire and 4-wire thermistors (2.2 kΩ 44004 type, 5 kΩ 44007 type and 10 kΩ 44006 type, see [Thermistor Requirements](#)), and, for the 34465A/70A only, type E, J, K, N, R, or T thermocouples.

Parameter	Typical Return
{FRTD RTD FTHermistor THERmistor TCouple}. Default: FRTD.	FRTD, RTD, FTH, TC, or THER
Configure 2-wire RTD measurements using an RTD with an R_0 of 100.1 Ω. Make and read two measurements: FUNC "TEMP" TEMP:TRAN:TYPE RTD TEMP:TRAN:FRTD:RES 100.1 SAMP:COUN 2 READ? Typical Response: +2.54530000E+01,+2.54570000E+01	

- TCouple applies only to the 34465A and 34470A.
- This parameter is set to its default value after a Factory Reset (*RST) or Instrument Preset (SYSTem:PRESet).

[SENSe:]TEMPerature:TRANsducer:TCouple:CHECK {ON|1|OFF|0}
 [SENSe:]TEMPerature:TRANsducer:TCouple:CHECK?

Disables or enables the *thermocouple check* feature to verify that your thermocouples are properly connected for measurements. When enabled, the instrument measures the resistance after each thermocouple measurement to ensure a proper connection. If an open connection is detected (greater than 5 kΩ on the 10 kΩ range), the instrument reports an overload condition.

Parameter	Typical Return
{ON 1 OFF 0}. Default: OFF.	0 (OFF) or 1 (ON)
Configure K-type thermocouple measurements. Select fixed reference junction and set reference junction temperature to +20 °C. Enable thermocouple check. Make and read two measurements: CONF:TEMP TC,K TEMP:TRAN:TC:RJUN:TYPE FIX TEMP:TRAN:TC:RJUN 20.0 TEMP:TRAN:TC:CHEC ON SAMP:COUN 2 READ? Typical Response: +3.31785468E+00,+3.61554515E+00	

- Applies only to the 34465A and 34470A.
- Enabling the thermocouple check feature slows measurement rates because two measurements have to be made for each temperature measurement values produced.
- This parameter is set to its default value after a Factory Reset (***RST**) or Instrument Preset (**SYSTem:PRESet**).

[SENSe:]TEMPerature:TRANsducer:TCouple:RJUNction {<temperature>|MIN|MAX|DEF}]

[SENSe:]TEMPerature:TRANsducer:TCouple:RJUNction? [{MIN|MAX|DEF}]

Sets the *fixed* reference junction temperature in degrees Celsius for thermocouple measurements.

Parameter	Typical Return
-20 °C to +80 °C. Default: 0 °C.	+2.00000000E+01 (always in degrees Celsius).
Configure K-type thermocouple measurements. Select fixed reference junction and set reference junction temperature to +20 °C. Enable thermocouple check. Make and read two measurements: CONF:TEMP TC,K TEMP:TRAN:TC:RJUN:TYPE FIX TEMP:TRAN:TC:RJUN 20.0 TEMP:TRAN:TC:CHEC ON SAMP:COUN 2 READ? Typical Response: +3.31785468E+00,+3.61554515E+00	

- Applies only to the 34465A and 34470A.
- For this command, you must always specify the temperature in degrees Celsius regardless of the temperature units currently selected (see **UNIT:TEMPerature** command).
- This parameter is set to its default value after a Factory Reset (***RST**) or Instrument Preset (**SYSTem:PRESet**).

[SENSe:]TEMPerature:TRANsducer:TCouple:RJUNction:OFFSet:ADJust {<temperature>|MIN|MAX|DEF}
 [SENSe:]TEMPerature:TRANsducer:TCouple:RJUNction:OFFSet:ADJust? [{MIN|MAX|DEF}]

Allows you to make minor temperature adjustments to correct for the differences between the DMM internal temperature measurement of the front connection and the actual temperature of the measurement terminals.

Parameter	Typical Return
-20 °C to +20 °C. Default: 0 °C.	+2.00000000E+01
<p>Configure thermocouple temperature measurements using the internal reference junction. Measure the temperature inside the instrument. Assuming the temperature outside the instrument is 5 °C cooler than the inside measurement, adjust the temperature by -5 °C. Then make and read one measurement:</p> <pre>CONF:TEMP TC,K TEMP:TRAN:TC:RJUN:TYPE INT TEMP:TRAN:TC:CHEC ON SYST:TEMP? TEMP:TRAN:TC:RJUN:OFFS:ADJ -5 READ?</pre> <p>Typical Response: +3.31785468E+00</p>	

- Applies only to the 34465A and 34470A.
- **Important:** Since the internal reference temperature is the temperature of the *front* connections, use of the *rear* connections with the selection of the internal reference junction will have an unknown error with no specified performance and is not recommended.
- This parameter is set to its default value after a Factory Reset (***RST**) or Instrument Preset (**SYSTem:PRESet**).

[SENSe:]TEMPerature:TRANsducer:TCouple:RJUNction:TYPE {INTernal|FIXed}

[SENSe:]TEMPerature:TRANsducer:TCouple:RJUNction:TYPE?

Thermocouple measurements require a reference junction temperature. For the reference junction temperature, you can use an *internal* measurement, or a known *fixed* junction temperature. This command selects the reference junction source for thermocouple measurements.

Parameter	Typical Return
{FIXed INTernal} default INT	FIX or INT
Configure K-type thermocouple measurements. Select fixed reference junction and set reference junction temperature to +20 °C. Enable thermocouple check. Make and read two measurements: CONF:TEMP TC,K TEMP:TRAN:TC:RJUN:TYPE FIX TEMP:TRAN:TC:RJUN 20.0 TEMP:TRAN:TC:CHEC ON SAMP:COUN 2 READ? Typical Response: +3.31785468E+00,+3.61554515E+00	

- Applies only to the 34465A and 34470A.
- **Important:** Since the internal reference temperature is the temperature of the *front* connections, use of the *rear* connections with the selection of the internal reference junction will have an unknown error with no specified performance and is not recommended.
- The accuracy of the measurement is highly dependent upon the thermocouple connections and the type of reference junction used. Use a *fixed* temperature reference for the highest accuracy measurements (you must maintain the known junction temperature).
- If you select a *fixed* reference junction source, you can specify a value between -20 °C and +80 °C using the [SENSe:]TEMPerature:TRANsducer:TCouple:RJUNction command. You must always specify the temperature in degrees Celsius regardless of the temperature units currently selected (see UNIT:TEMPerature command).
- You can read the internal reference junction temperature using the SYSTem:TEMPerature command.
- This parameter is set to its default value after a Factory Reset (*RST) or Instrument Preset (SYSTem:PRESet).

[SENSe:]TEMPerature:TRANsducer:TCouple:TYPE {E|J|K|N|R|T}
 [SENSe:]TEMPerature:TRANsducer:TCouple:TYPE?

Selects the thermocouple type for thermocouple measurements.

Parameter	Typical Return
{E J K N R T} default J	E, J, K, N, R, or T
Configure K-type thermocouple measurements. Select fixed reference junction and set reference junction temperature to +20 °C. Enable thermocouple check. Make and read two measurements: CONF:TEMP TC,K TEMP:TRAN:TC:RJUN:TYPE FIX TEMP:TRAN:TC:RJUN 20.0 TEMP:TRAN:TC:CHEC ON SAMP:COUN 2 READ? Typical Response: +3.31785468E+00,+3.61554515E+00	

- Applies only to the 34465A and 34470A.
- Thermocouple measurements require a reference junction temperature (see [SENSe:]TEMPerature:TRANsducer:TCouple:RJUNction:TYPE command). For the reference junction temperature, you can use an *internal* measurement, or a known *fixed* junction temperature. By default, an internal reference junction temperature is used.
- This parameter is set to its default value after a Factory Reset (*RST) or Instrument Preset (SYSTem:PRESet).

[SENSe:]TEMPerature:TRANsducer:{FTHermistor|THERmistor}:TYPE 5000
 [SENSe:]TEMPerature:TRANsducer:{FTHermistor|THERmistor}:TYPE?

Selects the thermistor type for 2-wire and 4-wire temperature measurements. Choosing the THERmistor or the FTHermistor command form makes no difference, as both commands affect the same parameter.

Parameter	Typical Return
5000 (only available choice)	+5000
Configure 4-wire thermistor measurements. Make and read two measurements: CONF:TEMP FTH TEMP:TRAN:FTH:TYPE 5000 SAMP:COUN 2 READ? Typical Response: +1.04530000E+02,+1.04570000E+02	

[SENSe:]TEMPerature:ZERO:AUTO {OFF|ON|ONCE}

[SENSe:]TEMPerature:ZERO:AUTO?

Disables or enables the autozero mode for 2-wire temperature measurements.

- **ON (default):** the DMM internally measures the offset following each measurement. It then subtracts that measurement from the preceding reading. This prevents offset voltages present on the DMM's input circuitry from affecting measurement accuracy.
- **OFF:** the instrument uses the last measured zero measurement and subtracts it from each measurement. It takes a new zero measurement each time you change the function, range or integration time.
- **ONCE:** the instrument takes one zero measurement and sets autozero OFF. The zero measurement taken is used for all subsequent measurements until the next change to the function, range or integration time. If the specified integration time is less than 1 PLC, the zero measurement is taken at 1 PLC to optimize noise rejection. Subsequent measurements are taken at the specified fast (< 1 PLC) integration time.

Parameter	Typical Return
{OFF ON ONCE}. Default: ON.	0 (OFF) or 1 (ON)
Configure 2-wire RTD measurements and perform an immediate zero autozero. Make and read two measurements: CONF:TEMP RTD TEMP:ZERO:AUTO ONCE SAMP:COUN 2 READ? Typical Response: +2.57530000E+01,+2.57570000E+01	

- Does not affect 4-wire resistance measurements, which are always made with autozero ON.
- The autozero mode is set indirectly when you set the resolution and integration time using **CONFig-ure:TEMPerature** or **MEASure:TEMPerature?**. Autozero is automatically turned OFF when you select an integration time less than 1 PLC with these commands.
- This parameter is set to its default value after a Factory Reset (***RST**) or Instrument Preset (**SYSTem:PRESet**).

[SENSe:]VOLTage Subsystem

This subsystem configures AC voltage, DC voltage, and ratio measurements.

Command Summary

[SENSe:]VOLTage:AC:BANDwidth

[SENSe:]VOLTage:{AC|DC}:NULL[:STATe]

[SENSe:]VOLTage:{AC|DC}:NULL:VALue

[SENSe:]VOLTage:{AC|DC}:NULL:VALue:AUTO

[SENSe:]VOLTage:{AC|DC}:RANGe

[SENSe:]VOLTage:{AC|DC}:RANGe:AUTO

[SENSe:]VOLTage:AC:SECondary

[SENSe:]VOLTage[:DC]:APERture

[SENSe:]VOLTage[:DC]:APERture:ENABled

[SENSe:]VOLTage[:DC]:IMPedance:AUTO

[SENSe:]VOLTage[:DC]:NPLC

[SENSe:]VOLTage[:DC]:RATio:SECondary

[SENSe:]VOLTage[:DC]:RESolution

[SENSe:]VOLTage[:DC]:SECondary

[SENSe:]VOLTage[:DC]:ZERO:AUTO

[SENSe:]VOLTage:AC:BANDwidth {<filter>|MIN|MAX|DEF}
 [SENSe:]VOLTage:AC:BANDwidth? [{MIN|MAX|DEF}]

Sets the bandwidth for AC voltage measurements.

The instrument uses three different AC filters that enable you either to optimize low frequency accuracy or to achieve faster AC settling times following a change in input signal amplitude. The instrument selects the slow (3 Hz), medium (20 Hz) or fast (200 Hz) filter based on the cutoff frequency specified by this command. Specify the lowest frequency that you expect to encounter.

Parameter	Typical Return
{3 Hz 20 Hz 200 Hz}. Default: 20Hz.	+2.00000000E+01
Make and read an AC voltage measurement. Use the 3 Hz filter bandwidth: CONF:VOLT:AC 100 VOLT:AC:BAND 3 READ?	

- If you enter the lowest expected frequency that you intend to encounter, the command will select the appropriate <filter>. For example, if you enter 15 Hz, the slow filter (3 Hz) is selected. If you enter 190 Hz, the medium filter (20 Hz) is selected to provide the appropriate low cutoff.
- Set the lowest frequency that you expect to encounter. Lower bandwidths result in longer settling delays, as shown:

Input Frequency	Default Settling Delay
3 Hz - 300 kHz (<i>Slow</i>)	2.5000 s/measurement
20 Hz - 300 kHz (<i>Medium</i>)	0.6250 s/measurement
200 Hz - 300 kHz (<i>Fast</i>)	0.0250 s/measurement

- This parameter is set to its default value after a Factory Reset (***RST**) or Instrument Preset (**SYSTem:PRESet**).

[SENSe:]VOLTage:{AC|DC}:NULL[:STATe] {ON|1|OFF|0}
 [SENSe:]VOLTage:{AC|DC}:NULL[:STATe]?

Enables or disables the null function for AC or DC voltage measurements.

NOTE This parameter setting is not shared between AC and DC measurements. The parameters are independent for AC and DC measurements.

Parameter	Typical Return
{ON 1 OFF 0}. Default: OFF.	0 (OFF) or 1 (ON)
Configure AC voltage measurements, using the null function to subtract 100 mV from the measurements. Make and read two measurements: CONF:VOLT:AC VOLT:AC:NULL:STAT ON;VAL 100 mV SAMP:COUN 2 READ? Typical Response: +1.04530000E+00,+1.04570000E+00	

- Enabling the scaling function also enables automatic null value selection ([SENSe:]VOLTage:{AC|DC}:NULL:VALue:AUTO ON).
- To set a fixed null value, use: [SENSe:]VOLTage:{AC|DC}:NULL:VALue.
- The null function is not available for DC ratio measurements.
- The instrument disables the null function after a Factory Reset (*RST), Instrument Preset (SYSTem:PRESet), or CONFigure function.

[SENSe:]VOLTage:{AC|DC}:NULL:VALue {<value>|MIN|MAX|DEF}
 [SENSe:]VOLTage:{AC|DC}:NULL:VALue? [{MIN|MAX|DEF}]

Stores a null value for voltage measurements.

NOTE This parameter setting is not shared between AC and DC measurements. The parameters are independent for AC and DC measurements.

Parameter	Typical Return
-1200 to +1200 V. Default: 0.	+1.00000000E-02
Configure AC voltage measurements, using the null function to subtract 100 mV from the measurements. Make and read two measurements: CONF:VOLT:AC VOLT:AC:NULL:STAT ON;VAL 100 mV SAMP:COUN 2 READ? Typical Response: +1.04530000E+00,+1.04570000E+00	

- Specifying a null value disables automatic null value selection ([SENSe:]VOLTage:{AC|DC}:NULL:VALue:AUTO OFF).
- To use the null value, the null state must be on ([SENSe:]VOLTage:{AC|DC}:NULL:STATe ON).
- The null function is not available for DC ratio measurements.
- This parameter is set to its default value after a Factory Reset (*RST), Instrument Preset (SYSTem:PRESet), or CONFigure function.

[SENSe:]VOLTage:{AC|DC}:NULL:VALue:AUTO {ON|1|OFF|0}
 [SENSe:]VOLTage:{AC|DC}:NULL:VALue:AUTO?

Enables or disables automatic null value selection for AC voltage or DC voltage measurements.

NOTE This parameter setting is not shared between AC and DC measurements. The parameters are independent for AC and DC measurements.

Parameter	Typical Return
{ON 1 OFF 0}. Default: OFF.	0 (OFF) or 1 (ON)
Configure AC voltage measurements, using the null function to subtract 100 mV from the measurements. Make and read two measurements: CONF:VOLT:AC VOLT:AC:NULL:STAT ON;VAL 100 mV SAMP:COUN 2 READ? Typical Response: +1.04530000E+00,+1.04570000E+00 Make a second set of measurements using automatic null value selection: VOLT:AC:NULL:VAL:AUTO ON READ? Typical Response: +0.00000000E+00,+0.01420000E+00	

- When automatic reference selection is ON, the first measurement made is used as the null value for all subsequent measurements. [SENSe:]VOLTage:{AC|DC}:NULL:VALue is set to this value. Automatic null value selection will be disabled.
- When automatic null value selection is disabled (OFF), the null value is specified by: [SENSe:]VOLTage:{AC|DC}:NULL:VALue.
- The instrument enables automatic null value selection when the null function is enabled ([SENSe:]VOLTage:{AC|DC}:NULL:STATe ON).
- The null function is not available for DC ratio measurements.
- This parameter is set to its default value after a Factory Reset (*RST), Instrument Preset (SYSTem:PRESet), or CONFigure function.

[SENSe:]VOLTage:{AC|DC}:RANGe {<range>|MIN|MAX|DEF}
 [SENSe:]VOLTage:{AC|DC}:RANGe? [{MIN|MAX|DEF}]

Selects a fixed measurement range for AC and DC voltage measurements and DC ratio measurements.

NOTE This parameter setting is not shared between AC and DC measurements. The parameters are independent for AC and DC measurements.

WARNING The maximum range parameter (MAX) is 1000 V. However, the SAFETY LIMIT on the front and rear HI/LO input terminals is 750 VAC (rms). The rms voltage is waveform dependent. A sine wave is limited to 750 VAC (rms), but a 1000 Vpk square wave is safe. Connection to AC mains power is further limited to CAT II (300 V). See **Safety and Regulatory Information** for more information on the safety features and the safe operation of this instrument.

Parameter	Typical Return
<range>: {100 mV 1 V 10 V 100 V 1000 V} AC default: 10 V DC default: 1000 V	+1.00000000E+01
Configure AC voltage measurements using the 100 V range. Make and read two measurements: CONF:VOLT:AC VOLT:AC:RANG 100 SAMP:COUN 2 READ? Typical Response: +3.24530000E+01,+3.24570000E+01	

- Selecting a fixed range ([SENSe:]<function>:RANGe) disables autoranging.
- If the input signal is greater than can be measured on the specified manual range, the instrument displays the word *Overload* on front panel and returns "9.9E37" from the remote interface.
- The instrument is set to the default range, with autoranging enabled ([SENSe:]VOLTage:{AC|DC}:RANGe:AUTO ON), after a Factory Reset (*RST) or an Instrument Preset (SYSTem:PRESet).

[SENSe:]VOLTage:{AC|DC}:RANGe:AUTO {OFF|ON|ONCE}
 [SENSe:]VOLTage:{AC|DC}:RANGe:AUTO?

Disables or enables autoranging for AC and DC voltage measurements and for DC ratio measurements. Autoranging is convenient because it automatically selects the range for each measurement based on the input signal.

Specifying ONCE performs an immediate autorange and then turns autoranging off.

NOTE This parameter setting is not shared between AC and DC measurements. The parameters are independent for AC and DC measurements.

WARNING The maximum range parameter (MAX) is 1000 V. However, the SAFETY LIMIT on the front and rear HI/LO input terminals is 750 VAC (rms). The rms voltage is waveform dependent. A sine wave is limited to 750 VAC (rms), but a 1000 Vpk square wave is safe. Connection to AC mains power is further limited to CAT II (300 V). See **Safety and Regulatory Information** for more information on the safety features and the safe operation of this instrument.

Parameter	Typical Return
{ON 1 OFF 0}. Default: ON.	0 (OFF) or 1 (ON)
Configure DC voltage measurements and perform an immediate autorange. Make and read two measurements: CONF:VOLT:AC VOLT:AC:RANG:AUTO ONCE SAMP:COUN 2 READ? Typical Response: +1.04530000E+01,+1.04570000E+01	

- Autoranging goes down a range at less than 10% of range and up a range at greater than 120% of range.
- With autoranging enabled, the instrument selects the range based on the input signal.
- Selecting a fixed range ([SENSe:]<function>:RANGe) disables autoranging.
- This parameter is set to its default value after a Factory Reset (*RST) or Instrument Preset (SYSTem:PRESet).

[SENSe:]VOLTage:AC:SECondary {"OFF"|"CALCulate:DATA"|"FREQUency"|"VOLTage[:DC]}
 [SENSe:]VOLTage:AC:SECondary?

Selects the secondary measurement function for AC voltage measurements.

Parameter	Typical Return
{"OFF" "CALCulate:DATA" "FREQUency" "VOLTage[:DC]"}, default "OFF"	"CALC:DATA"
Configure AC voltage measurements using the 100 V range. Select frequency as the secondary measurement. Make and retrieve measurements. CONF:VOLT:AC 100 VOLT:AC:SEC "FREQ" READ?;DATA2? Typical Response: +8.54530000E+01;+1.00000000E+03	

- "CALCulate:DATA" - (Applies only to the 34465A and 34470A.) The measurement value before any math operations are done (including NULL).
- "FREQUency" - The frequency measurement of the input signal.
- "VOLTage[:DC]" - The DC voltage measurement of the input signal. Applies only when using the instrument from the front panel. Setting is ignored for measurements made from a remote interface. If you require both AC and DC voltage measurements from remote, program each function separately, see **CONFigure[:VOLTage]:{AC|DC}**.
- Use **READ?** or **INITiate** to start the measurement.
- This parameter is set to its default value after a Factory Reset (***RST**) or Instrument Preset (**SYSTem:PRESet**).

[SENSe:]VOLTage[:DC]:APERture {<seconds>|MIN|MAX|DEF}
 [SENSe:]VOLTage[:DC]:APERture? [{MIN|MAX|DEF}]

Specifies the integration time in seconds (called *aperture time*) for dc voltage measurements.

NOTE Use this command for precise control of the DMM's integration time. Use NPLC (see **[SENSe:]VOLTage[:DC]:NPLC**) for better power-line noise rejection characteristics (NPLC > 1).

Parameter	Typical Return
(Without the DIG option) 200 μ s to 1 s (2 μ s resolution), default: 100 ms. (With the DIG option) 20 μ s to 1 s (2 μ s resolution), default: 100 ms.	+1.00000000E-01
Enable aperture time mode, set the aperture time to 300 ms: VOLT:APER:ENAB ON VOLT:DC:APER 300E-03	

- Applies only to the 34465A and 34470A.
- Both the [SENSe:]<function>:NPLC and [SENSe:]<function>:APERTure commands control the instrument's integration time. When using both commands (not recommended), whichever command is sent last will override the other command and set the integration time. Sending the [SENSe:]<function>:APERTure command sets the [SENSe:]<function>:APERTure:ENABLEd command to 1 (ON); sending [SENSe:]<function>:NPLC sets it to 0 (OFF).
- This parameter is set to its default value after a Factory Reset (*RST) or Instrument Preset (SYSTem:PRESet).

[SENSe:]VOLTage[:DC]:APERTure:ENABLEd {ON|1|OFF|0}

[SENSe:]VOLTage[:DC]:APERTure:ENABLEd?

Enables the setting of integration time in seconds (called *aperture time*) for dc voltage measurements. If aperture time mode is disabled (default), the integration time is set in PLC (power-line cycles).

Parameter	Typical Return
{ON 1 OFF 0}. Default: OFF.	0 (OFF) or 1 (ON)
Enable aperture time mode, set the aperture time to 300 ms: VOLT:APER:ENAB ON VOLT:DC:APER 300E-03	

- Applies only to the 34465A and 34470A.
- The CONFigure[:VOLTage][:DC], MEASure[:VOLTage][:DC]?, [SENSe:]VOLTage[:DC]:NPLC, and [SENSe:]VOLTage[:DC]:RESolution commands disable the aperture time mode, and select an integration time in number of power line cycles.
- This parameter is set to its default value after a Factory Reset (*RST) or Instrument Preset (SYSTem:PRESet).

[SENSe:]VOLTage[:DC]:IMPedance:AUTO {ON|1|OFF|0}
 [SENSe:]VOLTage[:DC]:IMPedance:AUTO?

Disables or enables automatic input impedance mode for DC voltage and ratio measurements.

Parameter	Typical Return
{ON 1 OFF 0}. Default: OFF.	0 (OFF) or 1 (ON)
Make all DC voltage measurements with a 10 MΩ input impedance: VOLT:IMP:AUTO OFF	

- **OFF:** the input impedance for DC voltage measurements is fixed at 10 MΩ for all ranges to minimize noise pickup.
- **ON:** the input impedance for DC voltage measurements varies by range. It is set to "HI-Z" (>10 GΩ) for the 100 mV, 1 V, and 10 V ranges to reduce the effects of measurement loading errors on these lower ranges. The 100 V and 1000 V ranges remain at a 10 MΩ input impedance.
- The **CONFigure** and **MEASure?** commands automatically select "AUTO OFF".
- This parameter is set to its default value after a Factory Reset (***RST**) or Instrument Preset (**SYSTem:PRESet**).

[SENSe:]VOLTage[:DC]:NPLC {<PLC>|MIN|MAX|DEF}
 [SENSe:]VOLTage[:DC]:NPLC? [{MIN|MAX|DEF}]

Sets the integration time in number of power line cycles (PLC) for DC voltage and ratio measurements. Integration time is the period that the instrument's analog-to-digital (A/D) converter samples the input signal for a measurement. A longer integration time gives better measurement resolution but slower measurement speed.

Parameter	Typical Return
0.02, 0.2, 1, 10, 100. Default: 10 (34460A/61A) 0.02, 0.06, 0.2, 1, 10, 100. Default: 10 (34465A/70A without DIG option) 0.001, 0.002, 0.006, 0.02, 0.06, .2, 1, 10, 100. Default: 10 (34465A/70A with DIG option) See Range, Resolution and NPLC for more information.	+1.00000000E+01
Configure DC voltage measurements using a 10 PLC integration time. Then make and read one measurement: CONF:VOLT:DC VOLT:DC:NPLC 10 READ? Typical Response: +6.27530000E-01	

- Only integration times of 1, 10, or 100 PLC provide normal mode (line frequency noise) rejection.
- Setting the integration time also sets the measurement resolution. [Resolution Table](#) shows the relationship between integration time and resolution. See [\[SENSe:\]VOLTage\[:DC\]:RESolution](#).
- This parameter is set to its default value after a Factory Reset (*RST) or Instrument Preset (SYSTem:PRESet).

[SENSe:]VOLTage[:DC]:RATio:SECOndary {"OFF"|"CALCulate:DATA"|"SENSe:DATA"}
 [SENSe:]VOLTage[:DC]:RATio:SECOndary?

Selects the secondary measurement function for DC ratio measurements.

Parameter	Typical Return
{"OFF" "CALCulate:DATA" "SENSe:DATA"}, default "OFF"	"CALC:DATA"
Configure the instrument for DC voltage ratio measurements using the 100 V range with 1 mV resolution. Select "SENSe:DATA" as the secondary measurement. Make and retrieve measurements. CONF:VOLT:DC:RAT 100,0.001 VOLT:RAT:SEC "SENS:DATA" READ?;DATA2? Typical Response: +1.05294698E+00;+2.10532098E+00,+1.99945584E+00	

- "CALCulate:DATA" - (Applies only to the 34465A and 34470A.) The measurement value before any math operations are done (including NULL).
- "SENSe:DATA" - The DC signal voltage and the DC reference voltage measurements.
- This parameter is set to its default value after a Factory Reset (*RST) or Instrument Preset (SYSTem:PRESet).

[SENSe:]VOLTage[:DC]:RESolution {<resolution>|MIN|MAX|DEF}
 [SENSe:]VOLTage[:DC]:RESolution? [{MIN|MAX|DEF}]

Selects the measurement resolution for DC voltage and ratio measurements. Specify the resolution in the same units as the selected measurement function, not in number of digits.

Parameter	Typical Return
<resolution>: See Resolution Table or Range, Resolution and NPLC . The default is equivalent to 10 PLC. Specify <resolution> in the measurement's units (V, A, Hz, Ω, and so on).	+3.00000000E-05
Configure DC voltage measurements with a 3 μV resolution. Then make and read one measurement: CONF:VOLT:DC 1 VOLT:DC:RES 3E-6 READ?	

- You can specify MIN (best resolution) or MAX (worst resolution) instead of <resolution>.
- To achieve normal mode (line frequency noise) rejection, use a resolution that corresponds to an integration time that is an integral number of power line cycles.
- This parameter is set to its default value after a Factory Reset (*RST) or Instrument Preset (SYSTem:PRESet).

[SENSe:]VOLTage[:DC]:SECondary {"OFF"|"CALCulate:DATA"|"VOLTage:AC"|"PTPeak"}
 [SENSe:]VOLTage[:DC]:SECondary?

Selects the secondary measurement function for DC voltage measurements.

Parameter	Typical Return
{"OFF" "CALCulate:DATA" "VOLTage:AC" "PTPeak"}, default "OFF"	"CALC:DATA"
Configure DC voltage measurements using the 10 V range with 1 mV resolution. Select peak-to-peak as the secondary measurement. Make and retrieve measurements. CONF:VOLT:DC 10,0.001 VOLT:DC:SEC "PTP" READ?;DATA2? Typical Response: -3.44948894E-03; +9.91000000E+3, +9.91000000E+3	

- "CALCulate:DATA" - (Applies only to the 34465A and 34470A.) The measurement value before any math operations are done (including NULL).
- "VOLTage:AC" - The AC voltage measurement of the input signal. Applies only when using the instrument from the front panel. Setting is ignored for measurements made from a remote interface. If you require both AC and DC voltage measurements from remote, program each function separately, see [CONFigure\[:VOLTage\]:{AC|DC}](#).
- "PTPeak" - The peak-to-peak, maximum, and minimum values of the input signal.
- This parameter is set to its default value after a Factory Reset (***RST**) or Instrument Preset (**SYSTem:PRESet**).

[SENSe:]VOLTage[:DC]:ZERO:AUTO {OFF|ON|ONCE}

[SENSe:]VOLTage[:DC]:ZERO:AUTO?

Disables or enables the autozero mode for DC voltage and ratio measurements.

- **ON (default):** the DMM internally measures the offset following each measurement. It then subtracts that measurement from the preceding reading. This prevents offset voltages present on the DMM's input circuitry from affecting measurement accuracy.
- **OFF:** the instrument uses the last measured zero measurement and subtracts it from each measurement. It takes a new zero measurement each time you change the function, range or integration time.
- **ONCE:** the instrument takes one zero measurement and sets autozero OFF. The zero measurement taken is used for all subsequent measurements until the next change to the function, range or integration time. If the specified integration time is less than 1 PLC, the zero measurement is taken at 1 PLC to optimize noise rejection. Subsequent measurements are taken at the specified fast (< 1 PLC) integration time.

Parameter	Typical Return
{OFF ON ONCE}	0 (OFF) or 1 (ON)
Configure DC voltage measurements and immediately autozero. Make and read two measurements: CONF:VOLT:DC 1 VOLT:DC:ZERO:AUTO ONCE SAMP:COUN 2 READ? Typical Response: +1.04530000E+01,+1.04570000E+01	

- The autozero mode is set indirectly when you set the resolution and integration time using CONFIgure:VOLTage:DC, CONFIgure:VOLTage:DC:RATio, MEASure:VOLTage:DC?, or MEASure:VOLTage:DC:RATio?. Autozero is automatically turned OFF when you select an integration time less than 1 PLC with these commands.
- This parameter is set to its default value after a Factory Reset (***RST**) or Instrument Preset (**SYSTem:PRESet**).

STATus Subsystem

Agilent 34460A/34461A/34465A/34470A Status System

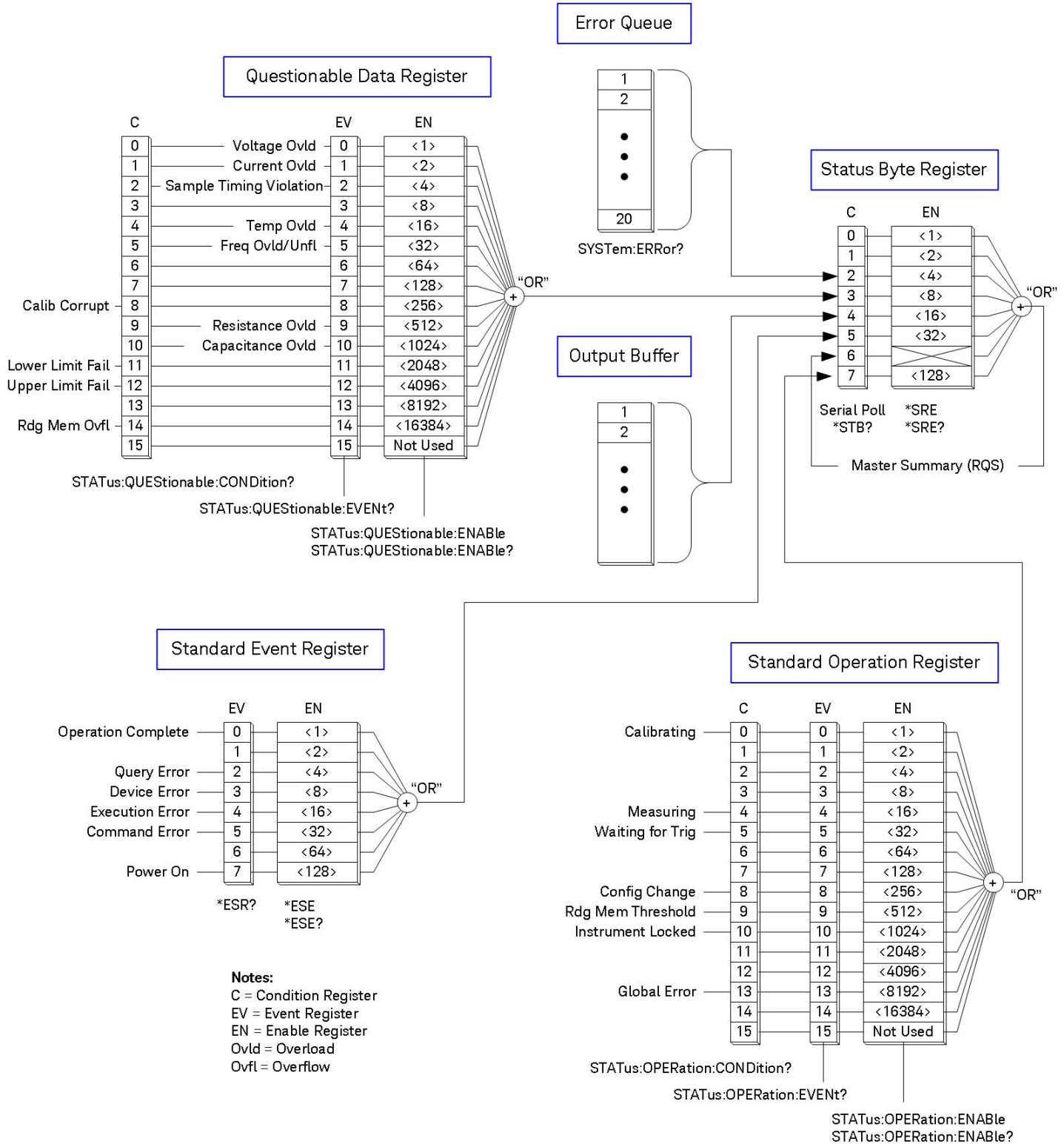

The following table lists the bit definitions for the *Questionable Data Register*:

NOTE The overload bits are set once per **INITiate** command. If you clear an overload bit, it is not set again until a new INITiate is sent.

Bit Number	Bit Name	Decimal Value	Definition
0	Voltage Overload	1	Only reported as event. Returns 0. Read the Event Register.
1	Current Overload	2	Only reported as event. Returns 0. Read the Event Register.
2	Sample Timing Violation	4	A sample timing violation has occurred involving the SAMPlE:TIMer command. Sample timing may not be valid. Applies only to the 34465A and 34470A.
3	Not Used	8	(Reserved for future use)
4	Temperature Overload	16	Only reported as event. Returns 0. Read the Event Register.
5	Frequency Overload/Underflow	32	Only reported as event. Returns 0. Read the Event Register.
6	Not Used	64	(Reserved for future use)
7	Not Used	128	(Reserved for future use)
8	Calibration Corrupt	256	At least one calibration constant is corrupt.
9	Resistance Overload	512	Only reported as event. Returns 0. Read the Event Register.
10	Capacitance Overload	1024	Only reported as event. Returns 0. Read the Event Register.
11	Lower Limit Failed	2048	The most recent measurement failed the lower limit test.
12	Upper Limit Failed	4096	The most recent measurement failed the upper limit test.
13	Not Used	8192	(Reserved for future use)
14	Memory Overflow	16384	Reading memory is full. One or more (oldest) measurements have been lost.
15	Not Used	32768	(Reserved for future use)

The following table lists the bit definitions for the *Standard Operation Register*:

Bit Number	Bit Name	Decimal Value	Definition
0	Calibrating	1	Instrument is performing a calibration.
1	Not Used	2	(Reserved for future use)
2	Not Used	4	(Reserved for future use)
3	Not Used	8	(Reserved for future use)
4	Measuring	16	Instrument is initiated, and is making or about to make a measurement.
5	Waiting for Trigger	32	Instrument is waiting for a trigger.
6	Not Used	64	(Reserved for future use)
7	Not Used	128	(Reserved for future use)
8	Configuration Change	256	Instrument configuration has been changed since the last INIT, READ? or MEASure?, either from the front panel or from SCPI.
9	Memory Threshold	512	Programmed number of measurements (DATA:POINTS:EVENT:THReshold) have been stored in measurement memory.
10	Instrument Locked	1024	Set if a remote interface (GPIB, USB or LAN) has a lock (SYSTem:LOCK:REQuest?). Cleared when the remote interface releases the lock (SYSTem:LOCK:RELease).
11	Not Used	2048	(Reserved for future use)
12	Not Used	4096	(Reserved for future use)
13	Global Error	8192	Set if any remote interface has an error in its error queue; cleared otherwise.
14	Not Used	16384	(Reserved for future use)
15	Not Used	32768	"0" is returned.

Command Summary

STATus:OPERation:CONDition?

STATus:OPERation:ENABLE

STATus:OPERation[:EVENT]?

STATus:PRESet

STATus:QUEStionable:CONDition?

STATus:QUEStionable:ENABLE

STATus:QUEStionable[:EVENT]?

STATus:OPERation:CONDition?

Returns the sum of the bits in the condition register for the **Standard Operation Register** group. This register is read-only; bits are not cleared when read.

A condition register continuously monitors the state of the instrument. Condition register bits are updated in real time; they are neither latched nor buffered.

Parameter	Typical Return
(none)	+32
Read the condition register (bit 5 is set): STAT:OPER:COND?	

- The condition register bits reflect the current condition. If a condition goes away, the corresponding bit is cleared in the condition register.

STATus:OPERation:ENABLE <enable_value>
STATus:OPERation:ENABLE?

Enables bits in the enable register for the **Standard Operation Register** group. The selected bits are then reported to the Status Byte. An enable register defines which bits in the event register will be reported to the Status Byte register group. You can write to or read from an enable register.

Parameter	Typical Return
A decimal value that corresponds to the binary-weighted sum of the bits in the register.	+32
Enable bit 5 (decimal value 32) in the enable register: STAT:OPER:ENAB 32	

- Use the <enable> parameter to specify which bits will be reported to the Status Byte. The decimal value specified corresponds to the binary-weighted sum of the bits you wish to enable in the register. For example, to enable bit 5 (decimal value = 32) and bit 9 (decimal value = 512), the corresponding decimal value would be 544 (32 + 512).
- A **STATus:PRESet** clears all bits in the enable register.
- The <enable> setting is nonvolatile; it does not change after a Factory Reset (***RST**), Instrument Pre-set (**SYSTem:PRESet**), Status Preset (**STATus:PRESet**) or Clear Status (***CLS**).
- The ***PSC** command controls whether the enable register is cleared at power on.

STATus:OPERation[:EVENT]?

Returns the sum of the bits in the event register for the **Standard Operation Register** group. An event register is a read-only register that latches events from the condition register. While an event bit is set, subsequent events corresponding to that bit are ignored. The register bits are cleared when you read the register.

Parameter	Typical Return
(none)	+512
Read the event register (bit 9 is set):	
STAT:OPER:EVEN?	

- Once a bit is set, it remains set until cleared by reading the event register or by sending ***CLS** (clear status).

STATus:PRESet

Clears **Questionable Data** enable register and **Standard Operation** enable register.

Parameter	Typical Return
(none)	(none)
Clear enable register bits:	
STAT:PRES	

STATus:QUEStionable:CONDition?

Returns the sum of the bits in the condition register for the **Questionable Data Register** group. This register is read-only; bits are not cleared when read.

A condition register continuously monitors the state of the instrument. Condition register bits are updated in real time; they are neither latched nor buffered.

Parameter	Typical Return
(none)	+4096
Read the condition register (bit 12 is set):	
STAT:QUES:COND?	

- The condition register bits reflect the current condition. If a condition goes away, the corresponding bit is cleared in the condition register.

STATus:QUESTIONable:ENABle <enable_value>
STATus:QUESTIONable:ENABle?

Enables bits in the enable register for the **Questionable Data Register** group. The selected bits are then reported to the Status Byte. An enable register defines which bits in the event register will be reported to the Status Byte register group. You can write to or read from an enable register.

Parameter	Typical Return
A decimal value that corresponds to the binary-weighted sum of the bits in the register.	+512
Enable bit 9 (decimal value 512) in the enable register.	

- Use the <enable> parameter to specify which bits will be reported to the Status Byte. The decimal value specified corresponds to the binary-weighted sum of the bits you wish to enable in the register. For example, to enable bit 0 (decimal value = 1), bit 1 (decimal value = 2) and bit 12 (decimal value = 4096), the corresponding decimal value would be 4099 (1 + 2 + 4096).
- A **STATus:PRESet** clears all bits in the enable register.
- The <enable> setting is nonvolatile; it does not change after a Factory Reset (***RST**), Instrument Pre-set (**SYSTem:PRESet**), Status Preset (**STATus:PRESet**) or Clear Status (***CLS**).
- The ***PSC** command controls whether the enable register is cleared at power on.

STATus:QUESTIONable[:EVENT]?

Returns the event register for the **Questionable Data Register** group. An event register is a read-only register that latches events from the condition register. While an event bit is set, subsequent events corresponding to that bit are ignored. The register bits are cleared when you read the register.

Parameter	Typical Return
(none)	+1024
Read the event register (bit 10 is set): STAT:QUES?	

- Once a bit is set, it remains set until cleared by reading the event register or by sending ***CLS** (clear status).

SYSTem Subsystem – General Purpose Commands

The SYSTem subsystem includes general commands (listed below), **license management commands**, and **remote interface configuration commands**.

Command Summary

SYSTem:ACALibration:DATE?

SYSTem:ACALibration:TEMPerature?

SYSTem:ACALibration:TIME?

SYSTem:BEEPer[:IMMEDIATE]

SYSTem:BEEPer:STATe

SYSTem:CLICk:STATe

SYSTem:DATE

SYSTem:ERRor[:NEXT]?

SYSTem:HELP?

SYSTem:IDENtify

SYSTem:LABel

SYSTem:LFRequency?

SYSTem:LOCal

SYSTem:PRESet

SYSTem:SECurity:COUNT?

SYSTem:SECurity:IMMEDIATE

SYSTem:TEMPerature?

SYSTem:TIME

SYSTem:UPTime?

SYSTem:VERSion?

SYSTem:WMESsage

SYSTem:ACALibration:DATE?

Returns the date of the last autocalibration in the format *yyyy,mm,dd*.

Parameter	Typical Return
(none)	2014,4,26
Return the autocalibration date: SYST:ACAL:DATE?	

- (34465A/70A only)
- You can perform this query regardless of whether the instrument is secured.
- The date is based on the instrument's real-time clock. Set the date for the instrument's real-time clock with **SYSTem:DATE**.
- The real-time clock does not adjust itself for time zone changes or daylight savings time. Be sure to set the date and time when you first receive your instrument.
- This setting is non-volatile; it will not be changed by power cycling or ***RST** or **SYSTem:PRESet**.
- Use ***CAL?** to perform autocal.

See Also

SYSTem:DATE

SYSTem:ACALibration:TEMPerature?

Returns the temperature of the last autocalibration in °C.

Parameter	Typical Return
(none)	+2.42850208E+001
Return the autocalibration temperature: SYST:ACAL:TEMP?	

- (34465A/70A only)
- You can perform this query regardless of whether the instrument is secured.
- This setting is non-volatile; it will not be changed by power cycling or ***RST** or **SYSTem:PRESet**.
- Use ***CAL?** to perform autocal.

SYSTem:ACALibration:TIME?

Returns the time of the last autocalibration in the format *hh,mm,ss.sss*.

Parameter	Typical Return
(none)	20,15,30.000
Return the calibration time: SYST:ACAL:TIME?	

- (34465A/70A only)
- The date is based on the instrument's real-time clock. Set the date for the instrument's real-time clock with SYSTem:DATE.
- The real-time clock does not adjust itself for time zone changes or daylight savings time. Be sure to set the date and time when you first receive your instrument.
- This parameter is set to its default value after a Factory Reset (***RST**) or Instrument Preset (**SYSTem:PRESet**).
- Use ***CAL?** to perform autocal.

See Also

SYSTem:TIME

SYSTem:BEEPer[:IMMEDIATE]

Issues a single beep.

Parameter	Typical Return
(none)	(none)
Issue a single beep: SYST:BEEP	

- Programmed beeps may be useful for program development and troubleshooting.
- You can issue a beep with this command regardless of the current beeper state (**SYSTem:BEEPer:STATE**).

SYSTem:BEEPer:STATe {ON|1|OFF|0}
SYSTem:BEEPer:STATe?

Disables or enables the beep heard during continuity, diode, or probe hold measurements, or when an error is generated from the front panel or remote interface.

Parameter	Typical Return
{ON 1 OFF 0}. Default: ON.	0 (OFF) or 1 (ON)
Disable beeper state: SYST:BEEP:STAT OFF	

- Does not affect the front panel key click.
- A beep is always emitted (even with beeper state OFF) when **SYSTem:BEEPer** is sent.
- This setting is non-volatile; it is not changed by power cycling, a Factory Reset (***RST**), or an Instrument Preset (**SYSTem:PRESet**).

SYSTem:CLICk:STATe {ON|1|OFF|0}
SYSTem:CLICk:STATe?

Disables or enables the click heard when a front panel key or softkey is pressed.

Parameter	Typical Return
{ON 1 OFF 0}. Default: ON.	0 (OFF) or 1 (ON)
Disable keyboard click: SYST:CLIC:STAT OFF	

- Does not affect the beeper for diode and continuity tests, errors and so on.
- This setting is non-volatile; it is not changed by power cycling, a Factory Reset (***RST**), or an Instrument Preset (**SYSTem:PRESet**).

SYSTem:DATE <year>, <month>, <day>

SYSTem:DATE?

Sets the date for the instrument's real-time clock. Use **SYSTem:TIME** to set the time.

Parameter	Typical Return
<year> 2000 to 2099 <month> 1 to 12 <day> 1 to 31	+2011,+07,+26
Set system date to July 26, 2011: SYST:DATE 2011, 7,26	

- The real-time clock is used for Mass Memory (MMEMory) system file time stamps.
- The real-time clock is battery-backed and retains the date and time when power is off.
- The date and time are not affected by ***RST** or **SYSTem:PRESet**.
- The real-time clock does not adjust itself for time zone changes or daylight savings time. Be sure to set the date and time when you first receive your instrument.

SYSTem:ERRor[:NEXT]?

Reads and clears one error from the error queue. See [SCPI Error Messages](#) for the complete SCPI error message list.

Parameter	Typical Return
(none)	-113,"Undefined header"
Read and clear the first error in the error queue: SYST:ERR?	

- Up to 20 errors can be stored in the instrument's error queue. Each remote interface I/O session (GPIB, USB, VXI-11, Telnet/Socket) has its own interface-specific error queue. Errors appear in the error queue of the I/O session that caused the error. For example, if an error was generated by a command sent over GPIB, send **SYSTem:ERRor?** from GPIB to read the error queue. Errors generated by instrument hardware are broadcast to all I/O sessions.
- Error retrieval is first-in-first-out (FIFO), and errors are cleared as you read them. The instrument beeps each time an error is generated (unless disabled by **SYSTem:BEEPer:STATe OFF**).
- If more than 20 errors have occurred, the most recent error stored in the queue is replaced with -350,"Queue overflow". No additional errors are stored until you remove errors from the queue. If no errors have occurred when you read the error queue, the instrument responds with +0,"No error".
- Errors have the following format (the error string may contain up to 255 characters).

<error code>,<error string>

Where:

<error code> = a positive or negative integer

<error string> = a quoted ASCII string up to 255 characters

See Also

***SRE**

SYSTem:HELP?

Returns a complete list of the instrument's SCPI commands.

Parameter	Typical Return
(none)	(see below)
Return the list of SCPI commands: SYST:HELP?	

- The query returns Definite Length Block Data, which allows any type of data to be transmitted as a series of 8-bit data bytes. The first line is a pound sign (#) followed by one digit representing the number of digits in the decimal integer to follow. This digit is followed by a decimal integer indicating the number of data bytes to follow, followed by the first New Line. (For example, "#47947" in the first line means that there are 7947 data bytes to follow.) The rest of the block has one command per line, each terminated by a New Line character (ASCII character 10).

The beginning of a returned list is shown below. Note that the actual contents may vary, depending on the firmware revision:

```
#48085
:ABORt/nquery/
:CALibration:ADC?/qonly/
:CALibration:ALL?/qonly/
:CALibration:COUNt?/qonly/
:CALibration:DATA
```

In this list,

- /nquery/ indicates a command with no query.
- /qonly/ indicates a query with no command form.
- All other commands consist of a command and query.
- Syntax for each command is found in the [Command Quick Reference](#).
- The list may include commands or queries not described in this document. These are deprecated commands included for compatibility with older instruments.

SYSTem:IDENtify {DEFAult|AT34460A|AT34461A|AT34410A|AT34411A|HP34401A}
SYSTem:IDENtify?

Selects the manufacturer and model number returned by ***IDN?**. The serial number and revision information are unaffected, and this command does not change instrument operation. Use to avoid changing existing test system code where the manufacturer/model number are verified.

Parameter	Typical Return
{DEFAult AT34460A AT34461A AT34410A AT34411A HP34401A} (see bullet points below)	DEF (see bullet points below), HP34401A, AT34410A, or AT34411A
Select a *IDN? response compatible with the 34401A:	
SYST:IDEN HP34401A *IDN?	
Typical Response: HEWLETT-PACKARD,34401A,...	

- The allowable parameters for each DMM model are:
 - 34460A - valid parameters: DEFAult, AT34460A, HP34401A
 - 34461A - valid parameters: DEFAult, AT34461A, HP34401A
 - 34465A - valid parameters: DEFAult, AT34410A, AT34411A
 - 34470A - valid parameters: DEFAult, AT34410A, AT34411A
- DEFAult returns "Keysight Technologies" followed by the actual instrument model number:
 - "Keysight Technologies,34460A, ..."
 - "Keysight Technologies,34461A, ..."
 - "Keysight Technologies,34465A, ..."
 - "Keysight Technologies,34470A, ..."
- If you have an older Agilent 34460A or 34461A and upgrade to the new (Keysight) firmware, your instrument continues to respond with the manufacturer name "Agilent", not "Keysight" until you set the front panel SCPI ID to 34460A or 34461A, send the **SYST:IDEN DEF** command, or reset user preferences. After doing this, the instrument responds with "Keysight" as the manufacturer.
- This setting is non-volatile; it is not changed by power cycling, a Factory Reset (***RST**), or an Instrument Preset (**SYSTem:PRESet**).
- **Important:** In order to update the instrument firmware *from remote*, the model number in the ***IDN?** response must match the actual instrument model number. If you have changed the instrument's ***IDN?** response to another instrument, when attempting to update the firmware from remote, you will see this error: *The instrument is not supported by this firmware file.* To update the firmware, either update using the front panel procedure or, from remote, use **SYSTem:IDENtify** to set the ***IDN?** to match the actual model number, update the firmware, and then use **SYSTem:IDENtify** again to set the ***IDN?** response to the other model number.

SYSTem:LABel "<string>"
SYSTem:LABel?

Places a message in a large font on the bottom half of the instrument's front panel display.

Parameter	Typical Return
A quoted string of up to 40 characters. You can use letters (A-Z), numbers (0-9) and special characters such as @, %, *, and so forth. Default ""	"Battery DCI"
Set the message to be displayed on the screen: SYST:LAB "Battery DCI" To turn off the message, send the following to change the label to a null string. This also removes the label area from the screen: SYST:LAB ""	

- If you enter a string longer than 40 characters, the instrument truncates the string after the first 40 characters.
- The font size changes based on the length of the message and whatever other information is shown on the display.
- The value of this parameter is not affected by ***RST** or **SYSTem:PRESet**.

SYSTem:LFRequency?

Queries the line frequency.

Parameter	Typical Return
(none)	+50
Query the line frequency: SYST:LFR?	

- At power on, the DMM sets the line frequency to the actual line frequency of either 50 Hz or 60 Hz (400 Hz is detected as 50 Hz).
- The line frequency value is not affected by ***RST** or **SYSTem:PRESet**.

SYSTem:LOCal

Sets the instrument state to local, clears the Remote display annunciator, and enables front-panel operation.

Parameter	Typical Return
(none)	(none)
Set the instrument state to local: SYST:LOC	

SYSTem:PRESet

This command is nearly identical to ***RST**. The difference is that ***RST** resets the instrument for SCPI operation, and SYSTem:PRESet resets the instrument for front panel operation. As a result, ***RST** turns the histogram and statistics off, and SYSTem:PRESet turns them on.

SYSTem:SECurity:COUNT?

Returns the instrument's security count.

Parameter	Typical Return
(none)	+22
Return the instrument's security count: SYSTem:SECurity:COUNT?	

- The security count is incremented by 1 every time you perform an action, other than calibration, that requires the instrument to be unsecured. This includes enabling or disabling interfaces, sanitizing memory per the NISPOM standard (**SYSTem:SECurity:IMMEDIATE**), updating firmware, changing the security code, or overriding the calibration security.
- The act of securing or unsecuring the instrument does not increment the counter.
- Be sure to read the security count upon receiving your instrument.

See Also

CALibration:COUNT?

SYSTem:SECurity:IMMEDIATE

(Requires the SEC option.) Sanitizes all user-accessible instrument memory except for the calibration constants and reboots the instrument. This complies with requirements in chapter 8 of the National Industrial Security Program Operating Manual (NISPOM).

Requires the optional security feature. See [Models and Options](#) for details.

CAUTION

The **NISPOM Sanitize** softkey and the SYSTem:SECurity:IMMEDIATE command are equivalent. They are for customers, such as military contractors, who must comply with NISPOM.

This feature destroys all user-defined state information, measurement data, and user-defined I/O settings such as the IP address. This feature is not recommended for use in routine applications because of the possibility of unintended data loss.

Parameter	Typical Return
(none)	(none)
Sanitize all user-accessible instrument memory: SYST:SEC:IMM	

- Typically used before removing an instrument from a secure area.
- Initializes all instrument settings to their Factory Reset (*RST) values. It also destroys all user-defined state and preference information (see [MMEMory Subsystem - STATE and PREFERENCE Files](#)).
- Increments the [security count](#).

SYSTem:TEMPerature?

Returns the instrument's internal temperature in °C.

Parameter	Typical Return
(none)	+2.85000000E+01
Return the instrument's internal temperature: SYST:TEMP?	

- The value returned is not affected by [UNIT:TEMPerature](#).

SYSTem:TIME <hour>, <minute>, <second>

SYSTem:TIME?

Sets the time for the instrument's real-time clock. Use SYSTem:DATE to set the date.

Parameter	Typical Return
<hour> 0 to 23 <minute> 0 to 59 <second> 0 to 60	20,15,30.000
Set instrument time to 20:15:30 (8:15:30 PM):	
SYST:TIME 20,15,30	

- The real-time clock is used for Mass Memory (MMEMory) system file time stamps.
- The real-time clock is battery-backed and retains the date and time when power is off.
- The date and time are not affected by ***RST** or **SYSTem:PRESet**.
- The real-time clock does not adjust itself for time zone changes or daylight savings time. Be sure to set the date and time when you first receive your instrument.

SYSTem:UPTime?

Returns the amount of time that the instrument has been running since the last power-on.

Parameter	Typical Return
(none)	+8,+2,+13,+50
Return time that the instrument has been running:	
SYST:UPT?	

- Typically used to verify that the instrument is warmed up sufficiently before calibration.
- The numbers returned indicate days, hours, minutes, and seconds, respectively.

SYSTem:VERSion?

Returns the version of SCPI (Standard Commands for Programmable Instruments) that the instrument complies with. There is no front panel equivalent. See [Introduction to the Introduction to the SCPI Language](#) for details.

Parameter	Typical Return
(none)	1994.0
Return the SCPI version:	
SYST:VERS?	

SYSTem:WMESsage "<string>"

SYSTem:WMESsage?

Displays a power-on message.

Parameter	Typical Return
A quoted string of up to 40 characters. You can use letters (A-Z), numbers (0-9) and special characters such as @, %, *, and so forth. Default ""	"RETURN TO JOE AT POST D6"
Display a power-on message: SYST:WMES "RETURN TO JOE AT POST D6"	

- Specifying a null string ("") disables the power-on message.
- This setting is non-volatile; it is not changed by power cycling, a Factory Reset (***RST**), or an Instrument Preset (**SYSTem:PRESet**).
- This parameter is set to its default value when the instrument is shipped from the factory and after **SYSTem:SECurity:IMMEDIATE**.

SYSTem Subsystem - I/O Configuration

The SYSTem subsystem includes **general instrument configuration commands**, **I/O locking commands**, **license management commands**, and remote interface configuration commands (listed below).

Command Summary

SYSTem:COMMunicate:ENABle

SYSTem:COMMunicate:GPIB:ADDReSS

SYSTem:COMMunicate:LAN:CONTRol?

SYSTem:COMMunicate:LAN:DHCP

SYSTem:COMMunicate:LAN:DNS[1|2]

SYSTem:COMMunicate:LAN:DOMain?

SYSTem:COMMunicate:LAN:GATeway

SYSTem:COMMunicate:LAN:HOSTname

SYSTem:COMMunicate:LAN:IPADdress

SYSTem:COMMunicate:LAN:MAC?

SYSTem:COMMunicate:LAN:SMASk

SYSTem:COMMunicate:LAN:TELNet:PROMpt

SYSTem:COMMunicate:LAN:TELNet:WMESsage

SYSTem:COMMunicate:LAN:UPDate

SYSTem:COMMunicate:LAN:WINS[1|2]

SYSTem:USB:HOST:ENABle

SYSTem:COMMunicate:ENABLE {ON|1|OFF|0}, <interface>
SYSTem:COMMunicate:ENABLE? <interface>

Disables or enables the GPIB, USB, or LAN remote interface. Also disables or enables available remote services such as Sockets, HiSLIP, Telnet, VXI11, and the built-in Web Interface.

NOTE The GPIB interface is an optional feature. See [Models and Options](#) for details.

Parameter	Typical Return
{ON 1 OFF 0}. Default: ON. for all interfaces	0 (OFF) or 1 (ON)
<interface>: {GPIB HISLip USB LAN SOCKETs TELNet VXI11 WEB USBMtp USBHost}	
Disable the USB interface: SYST:COMM:ENAB OFF,USB	

- After making changes, you must cycle instrument power for the changes to take effect.
- Enabling USBMtp allows you to transfer files, using media transfer protocol (MTP), from the instrument to a PC via the rear-panel USB port. See [Utility Menu - I/O Configuration](#) for more information on MTP.
- The USBHost parameter refers to the instrument's front panel USB port.
- If you disable the LAN interface, none of the associated LAN services will be started when you power on the instrument.
- **SYSTem:SECurity:IMMEDIATE** enables all interfaces except USBMtp.
- For HiSLIP, LAN, SOCKETs, TELNet, VXI11, or WEB on the 34460A, you must have option 34460A-LAN or option 3446LANU.
- The interface enable settings are stored in nonvolatile memory. They do not change when power has been off, after a Factory Reset (***RST**) or after an Instrument Preset (**SYSTem:PRESet**).

SYSTem:COMMunicate:GPIB:ADDRess <address>

SYSTem:COMMunicate:GPIB:ADDRess?

Assigns instrument's GPIB (IEEE-488) address, which is displayed at power-on. Each device on the GPIB interface must have a unique address.

NOTE

The GPIB interface is an optional feature. See [Models and Options](#) for details.

Parameter	Typical Return
0 to 30, default 22	+15
Set GPIB address to 15:	
SYST:COMM:GPIB:ADDR 15	

- Your computer's GPIB interface card has its own address. Avoid using this address for any instrument on the GPIB bus.
- Cycle power for this command to take effect.
- GPIB is enabled or disabled by [SYSTem:COMMunicate:ENABLE](#).
- The GPIB interface is an optional feature. See [Models and Options](#) for details.
- This setting is non-volatile; it is not changed by power cycling, a Factory Reset (***RST**), or an Instrument Preset ([SYSTem:PRESet](#)).
- This parameter is set to its default value when the instrument is shipped from the factory and after [SYSTem:SECurity:IMMEDIATE](#).

SYSTem:COMMunicate:LAN:CONTRol?

Reads the initial Control connection port number for Sockets communications. This connection is used to send and receive commands and queries.

Parameter	Typical Return
(none)	5000 (0 if the interface does not support sockets)
Return the Control connection port number:	
SYST:COMM:LAN:CONT?	

- Use the Control socket connection to send a Device Clear (DCL) to the instrument or to detect pending Service Request (SRQ) events.
- On the 34460A, this requires option 34460A-LAN or option 3446LANU.

SYSTem:COMMunicate:LAN:DHCP {ON|1|OFF|0}
SYSTem:COMMunicate:LAN:DHCP?

Disables or enables instrument's use of DHCP. The acronym DHCP stands for Dynamic Host Configuration Protocol, a protocol for assigning dynamic IP addresses to networked devices. With dynamic addressing, a device can have a different IP address every time it connects to the network.

ON: instrument tries to obtain an IP address from a DHCP server. If a DHCP server is found, it assigns a dynamic **IP address**, **Subnet Mask**, and **Default Gateway** to the instrument.

OFF or DHCP unavailable: instrument uses the static IP address, Subnet Mask, and Default Gateway during power-on.

NOTE If you change this setting, you must send **SYSTem:COMMunicate:LAN:UPDate** to activate the new setting.

Parameter	Typical Return
{ON 1 OFF 0}. Default: ON.	0 (OFF) or 1 (ON)
Disable DHCP:	
SYST:COMM:LAN:DHCP OFF	
SYST:COMM:LAN:UPDate	

- Most corporate LANs have a DHCP server.
- **SYSTem:SECurity:IMMEDIATE** sets this parameter to its default value.
- On the 34460A, this requires option 34460A-LAN or option 3446LANU.
- If a DHCP LAN address is not assigned by a DHCP server, then an Auto-IP address is obtained after approximately 2 minutes. An Auto-IP address has the form 169.254.nnn.nnn.
- This setting is non-volatile; it is not changed by power cycling, a Factory Reset (***RST**), or an Instrument Preset (**SYSTem:PRESet**).

SYSTem:COMMunicate:LAN:DNS[{1|2}**] "<address>"**
SYSTem:COMMunicate:LAN:DNS[{1|2}**]? [**{CURRENT|STATIC}**]**

Assigns static IP addresses of Domain Name System (DNS) servers. A primary and a secondary server address may be assigned. If DHCP is available and enabled, DHCP will auto-assign these server addresses. These auto-assigned server addresses take precedence over the static addresses assigned with this command. Contact your LAN administrator for details.

NOTE If you change this setting, you must send **SYSTem:COMMunicate:LAN:UPDate** to activate the new setting.

Parameter	Typical Return
Command: " nnn.nnn.nnn.nnn ". Default: "0.0.0.0".	"198.105.232.4"
Query: {CURRENT STATIC} . Default: CURRENT .	
Set a static primary DNS address: SYST:COMM:LAN:DNS "198.105.232.4" SYST:COMM:LAN:UPD	

- **CURRENT**: returns address currently being used by the instrument.
- **STATIC**: returns static address from non-volatile memory. This address is used if DHCP is disabled or unavailable.
- **SYSTem:SECurity:IMMediate** sets this parameter to its default value.
- On the 34460A, this requires option 34460A-LAN or option 3446LANU.
- The assigned DNS server addresses are used if DHCP is disabled or unavailable. Otherwise, the DNS server addresses are auto-assigned by DHCP.
- The DNS server addresses are stored in nonvolatile memory. They do not change when power has been off, after a Factory Reset (***RST**) or after an Instrument Preset (**SYSTem:PRESet**).

SYSTem:COMMunicate:LAN:DOMain?

Returns the domain name assigned to the instrument.

Parameter	Typical Return
(none)	"example.com"
Return the domain name being used by the instrument: SYST:COMM:LAN:DOM?	

- If Dynamic Domain Name System (DNS) is available on your network and your instrument uses **DHCP**, the domain name is assigned by the Dynamic DNS service at power-on.
- A null string ("") indicates that no domain name is assigned.
- On the 34460A, this requires option 34460A-LAN or option 3446LANU.

SYSTem:COMMunicate:LAN:GATeway "<address>"
SYSTem:COMMunicate:LAN:GATeway? [{CURRENT|STATIC}]

Assigns a default gateway for the instrument. The specified IP Address sets the default gateway, which allows the instrument to communicate with systems that are not on the local subnet. Thus, this is the default gateway where packets are sent that are destined for a device not on the local subnet, as determined by the **Subnet Mask** setting. Contact your LAN administrator for details.

NOTE If you change this setting, you must send **SYSTem:COMMunicate:LAN:UPDate** to activate the new setting.

Parameter	Typical Return
Command: "nnn.nnn.nnn.nnn". Default: "0.0.0.0".	"198.105.232.1"
Query: {CURRENT STATIC}. Default: CURRENT.	
Set default gateway address:	
SYST:COMM:LAN:GATEWAY "198.105.232.1"	
SYST:COMM:LAN:UPD	

- **CURRENT**: returns address currently being used by the instrument.
- **STATIC**: returns static address from non-volatile memory. This address is used if DHCP is disabled or unavailable.
- **SYSTem:SECurity:IMMEDIATE** sets this parameter to its default value.
- On the 34460A, this requires option 34460A-LAN or option 3446LANU.
- If DHCP is enabled (**SYSTem:COMMunicate:LAN:DHCP ON**), the specified default gateway is not used. However, if the DHCP server fails to assign a valid **IP address**, the currently configured default gateway is used.
- This setting is non-volatile; it is not changed by power cycling, a Factory Reset (***RST**), or an Instrument Preset (**SYSTem:PRESet**).

SYSTem:COMMunicate:LAN:HOSTname "<name>"
SYSTem:COMMunicate:LAN:HOSTname? [{CURRENT|STATIC}]

Assigns a hostname to the instrument. A hostname is the host portion of the domain name, which is translated into an IP address. If Dynamic Domain Name System (Dynamic DNS) is available on your network and your instrument uses DHCP, the hostname is registered with the Dynamic DNS service at power-on. If DHCP is enabled (SYSTem:COMMunicate:LAN:DHCP ON), the DHCP server can change the specified hostname.

NOTE If you change this setting, you must send **SYSTem:COMMunicate:LAN:UPDate** to activate the new setting.

Parameter	Typical Return
String of up to 15 characters. Must start with letter (A-Z) May contain letters, numbers (0-9), or dashes ("-") Default: "K-<instrument model number>-nnnnn", where nnnnn is the last five digits of the instrument's serial number.	"LAB1-34461A"
Define a hostname: SYST:COMM:LAN:HOST "LAB1-DMM" SYST:COMM:LAN:UPD	

- If no hostname exists, a null string ("") is returned.
- On the 34460A, this requires option 34460A-LAN or option 3446LANU.
- For the query form, specify "CURRENT" (default) to read the value currently being used by the instrument. Specify "STATIC" to read the host name currently stored in nonvolatile memory within the instrument (may not be the actual name used by the instrument if DHCP is enabled).
- This setting is non-volatile; it is not changed by power cycling, a Factory Reset (***RST**), or an Instrument Preset (**SYSTem:PRESet**).
- This parameter is set to its default value when the instrument is shipped from the factory and after **SYSTem:SECurity:IMMediate**.

SYSTem:COMMunicate:LAN:IPADdress "<address>"
SYSTem:COMMunicate:LAN:IPADdress? [{CURRENT|STATic}]

Assigns a static Internet Protocol (IP) address for the instrument. If DHCP is enabled (SYSTem:COMMunicate:LAN:DHCP ON), the specified static IP address is not used. Contact your LAN administrator for details.

NOTE If you change this setting, you must send **SYSTem:COMMunicate:LAN:UPDate** to activate the new setting.

Parameter	Typical Return
Command: "nnn.nnn.nnn.nnn"	"169.254.149.35"
Query: {CURRENT STATic}. Default: CURRENT.	
Set a static IP address:	
SYST:COMM:LAN:IPAD "169.254.149.35"	
SYST:COMM:LAN:UPD	

- **SYSTem:SECurity:IMMEDIATE** sets this parameter to its default value.
- On the 34460A, this requires option 34460A-LAN or option 3446LANU.
- For the query form, specify "CURRENT" (default) to read the value currently being used by the instrument. Specify "STATic" to read the value currently stored in nonvolatile memory within the instrument (may not be the actual address used by the instrument if DHCP is enabled).
- This setting is non-volatile; it is not changed by power cycling, a Factory Reset (***RST**), or an Instrument Preset (**SYSTem:PRESet**).
- This parameter is set to its default value when the instrument is shipped from the factory and after **SYSTem:SECurity:IMMEDIATE**.

SYSTem:COMMunicate:LAN:MAC?

Returns the instrument's Media Access Control (MAC) address as an ASCII string of 12 hexadecimal characters (0-9 and A-F) enclosed in quotation marks.

NOTE Your LAN administrator may need the MAC address to assign a static IP address for this device.

Parameter	Typical Return
(none)	"0030D3001041"
Return the MAC address:	
SYST:COMM:LAN:MAC?	

- On the 34460A, this requires option 34460A-LAN or option 3446LANU.
- The MAC address is also known as the link-layer address, the Ethernet (station) address, LANIC ID or Hardware Address. This is an unchangeable 48-bit address assigned by the manufacturer to each unique Internet device.

SYSTem:COMMunicate:LAN:SMASk "<mask>"
SYSTem:COMMunicate:LAN:SMASk? [{CURRENT|STATic}]

Assigns a subnet mask for the instrument to use in determining whether a client IP address is on the same local subnet. When a client **IP address** is on a different subnet, all packets must be sent to the **Default Gateway**. Contact your LAN administrator for details.

NOTE If you change this setting, you must send **SYSTem:COMMunicate:LAN:UPDate** to activate the new setting.

Parameter	Typical Return
Command: "nnn.nnn.nnn.nnn". Default: "255.255.0.0".	"255.255.255.0"
Query: {CURRENT STATic}. Default: CURRENT.	
Set the subnet mask:	
SYST:COMM:LAN:SMAS "255.255.255.0"	
SYST:COMM:LAN:UPD	

- On the 34460A, this requires option 34460A-LAN or option 3446LANU.
- If DHCP is enabled (**SYSTem:COMMunicate:LAN:DHCP ON**), the specified subnet mask is not used. However, if the DHCP server fails to assign a valid IP address, the instrument uses the Auto-IP subnet mask.
- A value of "0.0.0.0" or "255.255.255.255" indicates that subnetting is not being used.
- **SYSTem:SECurity:IMMEDIATE** sets this parameter to its default value.
- **CURRENT**: returns address currently being used by the instrument.
- **STATIC**: returns static address from non-volatile memory. This address is used if DHCP is disabled or unavailable.
- This setting is non-volatile; it is not changed by power cycling, a Factory Reset (***RST**), or an Instrument Preset (**SYSTem:PRESet**).

SYSTem:COMMunicate:LAN:TELNet:PROMpt "<string>"
SYSTem:COMMunicate:LAN:TELNet:PROMpt?

Sets the command prompt seen when communicating with the instrument via Telnet.

Parameter	Typical Return
String of up to 15 characters Default is Instrument Model Number: 34460A> , 34461A> , 34465A> , or 34470A>	"Command>"
Set the command prompt: SYST:COMM:LAN:TELN:PROM "Command>"	

- On the 34460A, this requires option 34460A-LAN or option 3446LANU.
- The instrument uses LAN port 5024 for SCPI Telnet sessions and port 5025 for SCPI Socket sessions.
- Telnet sessions are typically started from a host computer shell:

```
telnet <IP_address> <port>
```

For example:

```
telnet 169.254.4.10 5024
```

To exit a Telnet session, press <Ctrl-D>.

- This setting is non-volatile; it is not changed by power cycling, a Factory Reset (***RST**), or an Instrument Preset (**SYSTem:PRESet**).
- **SYSTem:SECurity:IMMEDIATE** sets this parameter to its default value.

SYSTem:COMMunicate:LAN:TELNet:WMESsage "<string>"
SYSTem:COMMunicate:LAN:TELNet:WMESsage?

Sets welcome message seen when communicating with instrument via Telnet.

Parameter	Typical Return
Quoted string of up to 63 characters. Default: "Welcome to Keysight's <instrument model number> Digital Multimeter"	"Welcome to the Telnet Session"
Define a welcome message: SYST:COMM:LAN:TELN:WMES "Welcome to the Telnet Session"	

- On the 34460A, this requires option 34460A-LAN or option 3446LANU.
- The instrument uses LAN port 5024 for SCPI Telnet sessions and port 5025 for SCPI Socket sessions.
- This setting is non-volatile; it is not changed by power cycling, a Factory Reset (***RST**), or an Instrument Preset (**SYSTem:PRESet**).
- **SYSTem:SECurity:IMMEDIATE** sets this parameter to its default value.

SYSTem:COMMunicate:LAN:UPDate

Stores any changes made to the LAN settings into non-volatile memory and restarts the LAN driver with the updated settings.

Parameter	Typical Return
(none)	(none)
(see below)	

- On the 34460A, this requires option 34460A-LAN or option 3446LANU.
- Must be sent after changing the settings for DHCP, DNS, gateway, hostname, IP address, subnet mask, or WINS.
- Make all changes to the LAN settings before sending this command.

Example

The following example configures the instrument to use statically assigned LAN settings.

```
SYST:COMM:LAN:DHCP OFF
SYST:COMM:LAN:DNS "198.105.232.4"
SYST:COMM:LAN:DNS2 "198.105.232.5"
SYST:COMM:LAN:GAT "198.105.232.1"
SYST:COMM:LAN:HOST "LAB1-DMM"
SYST:COMM:LAN:IPAD "198.105.232.101"
SYST:COMM:LAN:SMAS "255.255.255.0"
SYST:COMM:LAN:WINS "198.105.232.4"
SYST:COMM:LAN:WINS "198.105.232.5"
SYST:COMM:LAN:UPD
```

The following example configures the instrument back to use DHCP.

```
SYST:COMM:LAN:DHCP ON
SYST:COMM:LAN:UPD
```

SYSTem:COMMunicate:LAN:WINS[{1|2}**] "<address>"**
SYSTem:COMMunicate:LAN:WINS[{1|2}**]? [**{CURRENT|STATIC}**]**

Assigns the static IP addresses of the Windows Internet Name System (WINS) servers. A primary and a secondary server address may be assigned. If DHCP is available and enabled, DHCP will auto-assign these server addresses. These auto-assigned server addresses take precedence over the static addresses assigned with this command. Contact your LAN administrator for details.

NOTE If you change this setting, you must send **SYSTem:COMMunicate:LAN:UPDate** to activate the new setting.

Parameter	Typical Return
Command: " nnn.nnn.nnn.nnn ". Default: "0.0.0.0".	"198.105.232.4"
Query: {CURRENT STATIC} . Default: CURRENT .	
Set a static primary WINS address: SYST:COMM:LAN:WINS "198.105.232.4" SYST:COMM:LAN:UPD	

- On the 34460A, this requires option 34460A-LAN or option 3446LANU.
- The WINS addresses are stored in nonvolatile memory. They do not change when power has been off, after a Factory Reset (***RST**) or after an Instrument Preset (**SYSTem:PRESet**).
- **SYSTem:SECurity:IMMEDIATE** sets this parameter to its default value.
- **CURRENT**: returns address currently being used by the instrument.
- **STATIC**: returns static address from non-volatile memory. This address is used if DHCP is disabled or unavailable.

SYSTem:USB:HOST:ENABle {ON|1|OFF|0}
SYSTem:USB:HOST:ENABle?

Disables or enables the front panel USB host port. Calibration security must be unsecured (**CALibra-tion:SECure:STATe <code>,OFF**) before sending this command.

Parameter	Typical Return
{ON 1 OFF 0}. Default: OFF.	0 (OFF) or 1 (ON)
Disable the USB host port: CAL:SEC:STAT OFF,MY_CAL_CODE SYST:USB:HOST:ENAB OFF CAL:SEC:STAT ON	

- This feature requires the SEC licensed option. This option can be ordered as factory option or as customer-installable option. See **Models and Options** for details. Without this option, the front panel USB interface is always enabled.
- If the front panel USB host port is disabled, it cannot be used to store or load measurements, state files, preferences or other files or to perform firmware update.
- This setting is non-volatile; it is not changed by power cycling, a Factory Reset (***RST**), or an Instrument Preset (**SYSTem:PRESet**).

SYSTEM Subsystem LOCK Commands

This subsystem locks and releases instrument I/O interfaces, as shown in the following example:

Initial State = unlocked, Count = 0

```
(FROM USB) SYST:LOCK:REQ? returns "1" (request successful)
```

State = locked, Count = 1

```
(FROM GPIB) SYST:LOCK:REQ? returns "0" because USB has lock
```

State = locked, Count = 1

```
(FROM USB) SYST:LOCK:REQ? returns "1" (request successful)
```

State = locked, Count = 2

```
(FROM USB) SYST:LOCK:REL
```

State = locked, Count = 1

```
(FROM USB) SYST:LOCK:REL
```

State = unlocked, Count = 0

For each successful lock request, a lock release is required. Two requests require two releases.

Command Summary

SYSTem:LOCK:NAME?

SYSTem:LOCK:OWNer?

SYSTem:LOCK:RELease

SYSTem:LOCK:REQuest?

SYSTem:LOCK:NAME?

Returns the I/O interface in use by the querying computer.

Parameter	Typical Return
(none)	"LAN169.254.149.35"
See Interface Locking Example	

- After determining the interface that you are using, use **SYSTem:LOCK:OWNer?** to determine which interface, if any, has the lock.
- Returns "USB", "VXI11", "GPIB", "LAN<IP Address>", or "WEB<IP Address>" indicating the I/O interface being used by the querying computer.

SYSTem:LOCK:OWNer?

Returns the I/O interface that currently has a lock.

Parameter	Typical Return
(none)	"LAN169.254.149.35"
See Interface Locking Example	

- When a lock is active, Bit 10 in the Standard Operation Register will be set (**STATus:OPERa-tion:CONDition?**). When the lock is released on all I/O interfaces, this bit will be cleared.
- Returns "USB", "VXI11", "GPIB", "LAN<IP Address>", or "WEB<IP Address>" indicating the I/O interface that currently has a lock. If no interface has a lock, "NONE" is returned.

SYSTem:LOCK:RELease

Decrements the lock count by 1 and may release the I/O interface from which the command is executed.

Parameter	Typical Return
(none)	(none)
See Interface Locking Example	

- When a lock is active, Bit 10 in the Standard Operation Register will be set (**STATus:OPERa-tion:CONDition?**). When the lock is released on all I/O interfaces, this bit will be cleared.

SYSTem:LOCK:REQuest?

Requests a lock of the current I/O interface. This allows you to lock the instrument's configuration or cooperatively share the instrument with other computers.

Parameter	Typical Return
(none)	+0 (denied) or +1 (granted)
See Interface Locking Example	

- Lock requests can be nested; each request increases lock count by 1. For every request, you need a release (**SYSTem:LOCK:RELease**) from the same I/O interface.
- Locks are handled at the I/O interface level (USB, LAN, etc.) and you are responsible for all coordination between threads and/or programs on that interface.
- When a request is granted, only I/O sessions from the present interface can change the instrument state. You can only query the instrument state from other I/O interfaces.
- LAN sessions locks are automatically released when a LAN disconnect is detected.
- Granting a lock sets Bit 10 in the Standard Operation Register (**STATus:OPERation:CONDition?**). In addition, the entire instrument front panel, including the **Local** key, is locked out while a lock is in place ("Front panel locked." is displayed).

SYSTEM Subsystem LICense Commands

This subsystem manages licensed instrument options.

Command Summary

SYSTEM:LICense:CATalog?

SYSTEM:LICense:DELeTe

SYSTEM:LICense:DELeTe:ALL

SYSTEM:LICense:DESCription?

SYSTEM:LICense:ERRor?

SYSTEM:LICense:ERRor:COUNT?

SYSTEM:LICense:INSTall

SYSTEM:LICense:CATalog?

Returns a comma separated list of installed, **licensed options**. Only those installed options that require a license are returned. If no licensed options are found, the query returns "".

Parameter	Typical Return
(none)	"LAN","SEC"
Return currently licensed options:	
SYST:LIC:CAT?	

- This query returns a string with the following format:

```
34460A: "GPB","LAN","SEC"
```

```
34461A: "GPB","SEC"
```

```
34465A/70A: "GPB","SEC","DIG","MEM"
```

- Options vary by model, as **shown here**.

SYSTem:LiCense:DELeTe "<option_name>"

Deletes a license and disables the associated functionality.

NOTE If the security option is installed, you must unsecure the instrument with the security code (calibration password) to execute this command.

Parameter	Typical Return
"LAN" or "SEC" (34460A) "SEC" (34461A)	(none)
"DIG", "MEM", or "SEC" (34465A/70A)	
Delete LAN license: SYST:LIC:DEL "LAN"	

- Valid option names are double quoted strings representing the installed **licensed options**. Installed options can be easily identified using **SYSTem:LiCense:CATalog?**.
- Executing this command sets the instrument to the **factory default state**.

SYSTem:LiCense:DELeTe:ALL

Deletes all licenses and disables the associated functionality.

NOTE If the security option is installed, you must unsecure the instrument with the security code (calibration password) to execute this command.

Parameter	Typical Return
(none)	(none)
Delete all licenses: SYST:LIC:DEL:ALL	

- Executing this command sets the instrument to the **factory default state**.

SYSTem:LiCense:DESCRiption? "<option_name>"

Returns a description of the specified option, regardless of whether it is currently licensed.

Parameter	Typical Return
"LAN" or "SEC" (34460A) "SEC" (34461A) "DIG", "MEM", or "SEC" (34465A/70A)	"Enable instrument security"
Return description for option 34460A-LAN or option 3446LANU: SYST:LIC:DESC? "LAN"	

- Valid option names are double quoted strings representing the installed **licensed options**. Installed options can be easily identified using **SYSTem:LiCense:CATalog?**.

SYSTem:LiCense:ERRor?

Returns a string of all the errors produced by **SYSTem:LiCense:INSTall**.

Parameter	Typical Return
(none)	#279File: MyFile.lic<CR><LF>[Ignored - The license file is not formatted correctly.]<CR><LF>
Return the license installation error string:	
SYST:LIC:ERR?	

- The string can be up to 2096 characters.
- Returns a definite-length block containing multi-line ASCII text, including carriage returns and line feeds.

SYSTem:LiCense:ERRor:COUNT?

Returns the number of license errors generated by **SYSTem:LiCense:INSTall**.

Parameter	Typical Return
(none)	+0
Return number of license errors:	
SYST:LIC:ERR:COUN?	

SYSTem:LIcense:INSTall [{<folder>|<file>}]

SYSTem:LIcense:INSTall? "<option_name>"

Installs all licenses from a specified file or from all license files in the specified folder.

NOTE

If the security option is installed, you must unsecure the instrument with the security code (calibration password) to execute this command.

Parameter	Typical Return
<folder> may be any valid folder name. Default: root directory of a front panel USB storage device. <file> may be any valid license file name "LAN" or "SEC" (34460A) "SEC" (34461A) "DIG", "MEM", or "SEC" (34465A/70A)	0 (license not installed) or 1 (license installed)
Install licenses from license files in the \Licenses folder on a front panel USB storage device: SYST:LIc:INST "USB:\Licenses"	
Install licenses from the file "MyLicenses.lic" in the \Licenses folder on a front panel USB storage device: SYST:LIc:INST "USB:\Licenses\MyLicenses.lic"	
Return the status of the license "LAN": SYST:LIc:INST? "LAN"	
Typical Response: 0	

- License files must have a ".lic" file extension.
- The format for <file> is "[<drive>:<path>]<file_name>", where <drive> can be INTernal or USB, and <path> must be an absolute folder path.
 - INTernal specifies the internal flash file system. USB specifies a front panel USB storage device.
 - If <drive>:<path> is omitted, the folder specified by **MMEMory:CDIRectory** is used.
 - Absolute paths begin with "\" or "/" and start at the root folder of <drive>.
 - Folder and file names cannot contain the following characters: \ / : * ? " < > |
 - The combination of folder and file name cannot exceed 240 characters.
 - The specified folder must exist and cannot be marked as hidden or system.
- The format for <folder> is "[<drive>:<path>]", where <drive> can be INTernal or USB, and <path> is a folder path.
 - INTernal specifies the internal flash file system. USB specifies a front panel USB storage device.
 - If <drive> is specified, <path> is interpreted as an absolute folder path. Absolute paths begin with "\" or "/" and start at the root folder of <drive>.
 - If <drive> is omitted, <path> is relative to the folder specified by **MMEMory:CDIRectory**. Relative paths must NOT begin with \ or /.

- The *<folder>* parameter cannot exceed 240 characters.
- The specified folder must exist and cannot be marked as hidden or system.

TRIGger Subsystem

The TRIGger subsystem configures the triggering that controls measurement acquisition.

NOTE

Recommendation: All triggered measurements should be made using an appropriate fixed manual range. That is, turn autorange off ([SENSE:]<function>:RANGE:AUTO OFF) or set a fixed range using the [SENSE:]<function>:RANGE, **CONFigure**, or **MEASure** command.

Command Summary

TRIGger:COUNT

TRIGger:DELay

TRIGger:DELay:AUTO

TRIGger:LEVel

TRIGger:SLOPe

TRIGger:SOURce

TRIGger:COUNT {<count>|MIN|MAX|DEF|INFinity}
TRIGger:COUNT? [{MIN|MAX|DEF}]

Selects the number of triggers that are accepted by the instrument before returning to the "idle" trigger state.

Parameter	Typical Return
1 to 1,000,000 (1x10 ⁶) or continuous (INFinity). Default: 1. (34460A/61A) 1 to 1,000,000,000 (1x10 ⁹) or continuous (INFinity). Default: 1. (34465A/70A)	+1.00000000E+00 For a continuous trigger (INFinity), the query returns "9.9E37".
Return ten sets of five DC voltage measurements, using a positive-going external trigger to start each measurement set: CONF:VOLT:DC SAMP:COUN 5 TRIG:COUN 10 TRIG:SOUR EXT;SLOP POS READ? Typical Response: +1.00520000E+01, ... (50 measurements)	

- You can use the specified trigger count in conjunction with a sample count (**SAMPle:COUNT**), which sets the number of samples to be made per trigger. In this case, the number of measurements returned is the sample count multiplied by the trigger count.
- You can store up to 1,000 measurements in the reading memory of the 34460A, 10,000 measurements on the 34461A, 50,000 measurements on the 34465A/70A (*without* the MEM option), or 2,000,000 measurements on the 34465A/70A (*with* the MEM option). If reading memory overflows, new measurements overwrite the oldest measurements stored; the most recent measurements are always preserved. No error is generated, but the Reading Mem Ovfl bit (bit 14) is set in the Questionable Data Register's condition register (see **Status System Introduction**).
- A variable trigger count is not available from the front panel. If you set the trigger count and then go to local (front panel), the instrument ignores the trigger count setting; however, when you return to remote, the trigger count returns to the previous value you selected.
- This parameter is set to its default value after a Factory Reset (***RST**) or Instrument Preset (**SYSTem:PRESet**).

TRIGger:DElay {<seconds>|MIN|MAX|DEF}
TRIGger:DElay? [{MIN|MAX|DEF}]

Sets the delay between the trigger signal and the first measurement. This may be useful in applications where you want to allow the input to settle before taking a measurement or for pacing a burst of measurements.

Selecting a specific trigger delay disables the automatic trigger delay (**TRIGger:DElay:AUTO OFF**).

NOTE For AC measurements (voltage or current), there is a relationship between the bandwidth setting (**[SENSe:]VOLTage:AC:BANDwidth** or **[SENSe:]CURRent:AC:BANDwidth**) and the default trigger delay setting. This delay ensures that there is sufficient settling time for the AC measurement. See **Automatic Trigger Delays** for further information.

Parameter	Typical Return
0 to ~3600 seconds (~1 μs steps). Default: 1 s. Step size for DC measurements is approximately 1 μs. Step size depends on AC bandwidth for AC measurements.	+2.00000806E+00
Return five DC voltage measurements. There is a 2 second delay before each measurement. CONF:VOLT:DC 10 SAMP:COUN 5 TRIG:DEL 2 READ? Typical Response: +4.27230000E+00,+4.27150000E+00,+4.27190000E+00,+4.27170000E+00,+4.27200000E+00	

- Due to internal quantization, the actual delay that you set may be slightly different than your specified value. The increment is approximately 1 μs.
- By default, **TRIGger:DElay:AUTO** is ON. The instrument automatically determines the delay based on function, range and integration time (see **Automatic Trigger Delays**). However, you may need to set a delay longer than the automatic delay for long cables, high capacitance or high impedance signals.
- If you specify a trigger delay with this command, that delay is used for *all* functions (*except* **CONTinuity** and **DIODE**) and ranges. The **CONTinuity** and **DIODE** tests ignore the trigger delay setting.
- If you have configured the instrument for more than one measurement per trigger (**SAMPle:COUNT** >1), the delay is inserted after the trigger and between consecutive measurements.
- The instrument selects automatic trigger delay after a Factory Reset (***RST**) or an Instrument Preset (**SYSTem:PRESet**).

TRIGger:DElay:AUTO {ON|1|OFF|0}
TRIGger:DElay:AUTO?

Disables or enables automatic trigger delay. If enabled, the instrument determines the delay based on function, range, and integration time or bandwidth.

Parameter	Typical Return
{ON 1 OFF 0}. Default: ON.	0 (OFF) or 1 (ON)
Return 5 DC voltage measurements, with an automatic delay between each measurement.	
CONF:VOLT:DC 10 SAMP:COUN 5 TRIG:DEL 2 READ?	
Typical Response: +4.27230000E+00,+4.27150000E+00,+4.27190000E+00,+4.27170000E+00,+4.27200000E+00	

- Selecting a specific trigger delay using **TRIGger:DElay** disables the automatic trigger delay.
- This parameter is set to its default value after a Factory Reset (***RST**) or Instrument Preset (**SYSTem:PRESet**).

TRIGger:LEVel {<level>|MIN|MAX|DEF}
TRIGger:LEVel? [{MIN|MAX|DEF}]

Sets the level on which a trigger occurs when level triggering is enabled (**TRIGger:SOURce** set to **INTernal**).

NOTE It is recommended that all triggered measurements be made using an appropriate fixed manual range. That is, turn autorange off (**SENSe:<function>:RANGe:AUTO OFF**), or set a fixed range using the **SENSe:<function>:RANGe**, **CONFigure**, or **MEASure** command.

Parameter	Typical Return
<level> (see bullet points below). Default: 0.	+2.00000000E+01
Configures dc voltage measurements, 1 V range, 0.1 mV resolution. Select internal trigger source. Set the trigger level to 0.75 volts, positive slope. INIT puts the instrument in the "wait for trigger" mode.	
CONF:VOLT:DC 1,0.0001 TRIG:SOUR INT TRIG:LEV 0.75 TRIG:SLOP POS INIT	

- Applies only to the 34465A and 34470A, and requires the DIG option.
- Supported only for ac and dc voltage, ac and dc current, frequency, period, 2-wire resistance, 4-wire resistance, RTD and thermistor temperature measurements. Resistance and temperature measurements must have offset compensation and low power disabled.

- To use the trigger level you must select INTernal as the trigger source with the **TRIGger:SOURce** command.
- If you are using a wide aperture (NPLC or aperture mode) and the signal level varies significantly within the aperture, you may get an unexpected variation in the magnitude of the triggered measurement from the specified trigger level.
- This parameter is set to its default value after a Factory Reset (***RST**) or Instrument Preset (**SYSTem:PRESet**).
- Specify *<level>* in the fundamental units for the function (volts, ohms, amps, hertz, or seconds). The table below shows the allowable values for *<level>* for each measurement function, range, and input terminals (for DCI and ACI).

Measurement Function	Range/Input Terminals	<i><level></i> Parameter Value
DCV	100 mV to 100 V ranges, fixed range	±120% of range
	1000 V range, fixed range	±1000 V
	Autorange	±1000 V
DCI	3 A terminals, fixed range	±120% of range
	3 A terminals, autorange	±3.6 A
	10 A terminals	±12 A
RESistance/FRESistance	All ranges, fixed range	0 to +120% of range
	Autorange	0 to +1.2 GΩ
ACV	100 mV to 100 V ranges, fixed range	0 to +120% of range
	750 V range, fixed range	0 to +1000 V
	Autorange	0 to +1000 V
ACI	3 A terminals, fixed range	0 to +120% of range
	3 A terminals, autorange	0 to +3.6 A
	10 A terminals	0 to +12 A
FREQuency	*N/A	3 Hz to 300 kHz
PERiod	*N/A	3.33333333 μs to 0.333333333 s

*N/A = Not Applicable.

See Also

TRIGger:DELay

TRIGger:SOURce

TRIGger:SLOPe {POSitive|NEGative}
TRIGger:SLOPe?

Selects whether the instrument uses the rising edge (POS) or the falling edge (NEG) of the trigger signal on the rear-panel *Ext Trig* BNC connector when external triggering is selected; or the rising or falling edge of the input signal when level triggering is selected (level triggering applies only to the 34465A and 34470A).

Parameter	Typical Return
{POSitive NEGative}. Default: NEG	POS or NEG
Return ten sets of five DC voltage measurements, using a positive-going external trigger to start each measurement set: CONF:VOLT:DC SAMP:COUN 5 TRIG:COUN 10 TRIG:SOUR EXT;SLOP POS READ? Typical Response: +1.00520000E+01, ... (50 measurements)	

- On the 34460A, this requires option 34460A-LAN or option 3446LANU.
- This parameter is set to its default value after a Factory Reset (***RST**) or Instrument Preset (**SYSTem:PRESet**).

TRIGger:SOURce {IMMEDIATE|EXTERNAL|BUS|INTERNAL}
TRIGger:SOURce?

Selects the trigger source for measurements.

NOTE

It is recommended that all triggered measurements be made using an appropriate fixed manual range. That is, turn autorange off (**SENSe:<function>:RANGe:AUTO OFF**), or set a fixed range using the **SENSe:<function>:RANGe**, **CONFigure**, or **MEASure** command.

Source	Description
IMMediate	The trigger signal is always present. When you place the instrument in the "wait-for-trigger" state, the trigger is issued immediately.
BUS	The instrument is triggered by *TRG over the remote interface once the DMM is in the "wait-for-trigger" state.
EXTErnal	The instrument accepts hardware triggers applied to the rear-panel Ext Trig input and takes the specified number of measurements (SAMPle:COUNT), each time a TTL pulse specified by OUTPut:TRIGger:SLOPe is received. If the instrument receives an external trigger before it is ready, it buffers one trigger.
INTernal	The INTernal source is available for the 34465A and 34470A with the DIG option only, and provides level triggering capability. To trigger on a level on the input signal, select INTernal for the source, and set the level and slope with the TRIGger:LEVel and TRIGger:SLOPe commands.

Parameter	Typical Return
{IMMediate EXTErnal BUS INTernal}. Default: IMMediate.	IMM, EXT, or BUS
Return ten sets of five DC voltage measurements, using a positive-going external trigger to start each measurement set: CONF:VOLT:DC SAMP:COUN 5 TRIG:COUN 10 TRIG:SOUR EXT;SLOP POS READ? Typical Response: +1.00520000E+01, ... (50 measurements)	

- On the 34460A, EXTErnal requires option 34460-LAN or option 3446LANU.
- After selecting the trigger source, you must place the instrument in the "wait-for-trigger" state by sending **INITiate** or **READ?**. A trigger is not accepted from the selected trigger source until the instrument is in the "wait-for-trigger" state.
- This parameter is set to its default value after a Factory Reset (***RST**) or Instrument Preset (**SYSTem:PRESet**).
- Recommendation: All triggered measurements should be made using an appropriate fixed manual range. That is, turn autorange off (**[SENSe:]<function>:RANGe:AUTO OFF**) or set a fixed range using the **[SENSe:]<function>:RANGe**, **CONFigure**, or **MEASure** command.
- This parameter is set to its default value after a Factory Reset (***RST**) or Instrument Preset (**SYSTem:PRESet**).

Command Quick Reference

Be sure to read [language syntax conventions](#). Commands or parameters shown in [blue](#) apply only to the 34465A/70A, all other commands/parameters apply to all Truevolt DMMs.

Configuration Commands

CONFigure?

CONFigure:CAPacitance [{<range>|AUTO|MIN|MAX|DEF} [, {<resolution>|MIN|MAX|DEF}]]

CONFigure:CONTinuity

CONFigure:CURREnt:{AC|DC} [{<range>|AUTO|MIN|MAX|DEF} [, {<resolution>|MIN|MAX|DEF}]]

CONFigure:DIODE

CONFigure:{FREQuency|PERiod} [{<range>|MIN|MAX|DEF} [, {<resolution>|MIN|MAX|DEF}]]

CONFigure:{RESistance|FRESistance} [{<range>|AUTO|MIN|MAX|DEF} [, {<resolution>|MIN|MAX|DEF}]]

CONFigure:TEMPerature [{FRTD|RTD|FTHermistor|THERmistor|TCouple|DEFault} [, {<type>|DEFault} [, 1 , {<resolution>|MIN|MAX|DEF}]]]]

CONFigure[:VOLTage]:{AC|DC} [{<range>|AUTO|MIN|MAX|DEF} [, {<resolution>|MIN|MAX|DEF}]]

CONFigure[:VOLTage][:DC]:RATio [{<range>|AUTO|MIN|MAX|DEF} [, {<resolution>|MIN|MAX|DEF}]]

Measurement Commands

MEASure:CAPacitance? [{<range>|AUTO|MIN|MAX|DEF} [, {<resolution>|MIN|MAX|DEF}]]

MEASure:CONTinuity?

MEASure:CURREnt:{AC|DC}? [{<range>|AUTO|MIN|MAX|DEF} [, {<resolution>|MIN|MAX|DEF}]]

MEASure:DIODE?

MEASure:{FREQuency|PERiod}? [{<range>|MIN|MAX|DEF} [, {<resolution>|MIN|MAX|DEF}]]

MEASure:{RESistance|FRESistance}? [{<range>|AUTO|MIN|MAX|DEF} [, {<resolution>|MIN|MAX|DEF}]]

MEASure:TEMPerature? [{FRTD|RTD|FTHermistor|THERmistor|TCouple|DEFault} [, {<type>|DEFault} [, 1 , {<resolution>|MIN|MAX|DEF}]]]]

MEASure[:VOLTage]:{AC|DC}? [{<range>|AUTO|MIN|MAX|DEF} [, {<resolution>|MIN|MAX|DEF}]]

MEASure[:VOLTage][:DC]:RATio? [{<range>|AUTO|MIN|MAX|DEF} [, {<resolution>|MIN|MAX|DEF}]]

Measurement Configuration Commands

[SENSe:]FUNCTion[:ON] "<function>"

[SENSe:]FUNCTion[:ON]?

AC and DC Voltage and DC Ratio Configuration Commands

```

CONFigure[:VOLTage]:{AC|DC} [{<range>|AUTO|MIN|MAX|DEF} [, {<resolution>|MIN|MAX|DEF}]]
CONFigure[:VOLTage][:DC]:RATio [{<range>|AUTO|MIN|MAX|DEF} [, {<resolution>|MIN|MAX|DEF}]]
CONFigure?

[SENSe:]VOLTage:AC:BANDwidth {<filter>|MIN|MAX|DEF}
[SENSe:]VOLTage:AC:BANDwidth? [{MIN|MAX|DEF}]

[SENSe:]VOLTage:{AC|DC}:NULL[:STATe] {OFF|ON}
[SENSe:]VOLTage:{AC|DC}:NULL[:STATe]?

[SENSe:]VOLTage:{AC|DC}:NULL:VALue {<value>|MIN|MAX|DEF}
[SENSe:]VOLTage:{AC|DC}:NULL:VALue? [{MIN|MAX|DEF}]

[SENSe:]VOLTage:{AC|DC}:NULL:VALue:AUTO {OFF|ON}
[SENSe:]VOLTage:{AC|DC}:NULL:VALue:AUTO?

[SENSe:]VOLTage:{AC|DC}:RANGe {<range>|MIN|MAX|DEF}
[SENSe:]VOLTage:{AC|DC}:RANGe? [{MIN|MAX|DEF}]

[SENSe:]VOLTage:{AC|DC}:RANGe:AUTO {OFF|ON|ONCE}
[SENSe:]VOLTage:{AC|DC}:RANGe:AUTO?

[SENSe:]VOLTage:AC:SECondary {"OFF"|"CALCulate:DATA"|"FREQuency"|"VOLTage[:DC]"}
[SENSe:]VOLTage:AC:SECondary?

[SENSe:]VOLTage[:DC]:APERture {<seconds>|MIN|MAX|DEF}
[SENSe:]VOLTage[:DC]:APERture? [{MIN|MAX|DEF}]

[SENSe:]VOLTage[:DC]:APERture:ENABled {OFF|ON}
[SENSe:]VOLTage[:DC]:APERture:ENABled?

[SENSe:]VOLTage[:DC]:IMPedance:AUTO {OFF|ON}
[SENSe:]VOLTage[:DC]:IMPedance:AUTO?

[SENSe:]VOLTage[:DC]:NPLC {<PLCs>|MIN|MAX|DEF}
[SENSe:]VOLTage[:DC]:NPLC? [{MIN|MAX|DEF}]

[SENSe:]VOLTage[:DC]:RATio:SECondary {"OFF"|"CALCulate:DATA"|"SENSe:DATA"}
[SENSe:]VOLTage[:DC]:RATio:SECondary?

[SENSe:]VOLTage[:DC]:RESolution {<resolution>|MIN|MAX|DEF}
[SENSe:]VOLTage[:DC]:RESolution? [{MIN|MAX|DEF}]

[SENSe:]VOLTage[:DC]:SECondary {"OFF"|"CALCulate:DATA"|"VOLTage:AC"|"PTPeak"}
[SENSe:]VOLTage[:DC]:SECondary?

[SENSe:]VOLTage[:DC]:ZERO:AUTO {OFF|ON|ONCE}
[SENSe:]VOLTage[:DC]:ZERO:AUTO?

```

2-Wire and 4-Wire Resistance Configuration Commands

CONFigure:{RESistance|FRESistance} [{<range>|AUTO|MIN|MAX|DEF} [, {<resolution>|MIN|MAX|DEF}]]

CONFigure?

[SENSe:]{RESistance|FRESistance}:APERTure {<seconds>|MIN|MAX|DEF}

[SENSe:]{RESistance|FRESistance}:APERTure? [{MIN|MAX|DEF}]

[SENSe:]{RESistance|FRESistance}:APERTure:ENABled {OFF|ON}

[SENSe:]{RESistance|FRESistance}:APERTure:ENABled?

[SENSe:]{RESistance|FRESistance}:NPLC {<PLCs>|MIN|MAX|DEF}

[SENSe:]{RESistance|FRESistance}:NPLC? [{MIN|MAX|DEF}]

[SENSe:]{RESistance|FRESistance}:NULL[:STATe] {OFF|ON}

[SENSe:]{RESistance|FRESistance}:NULL[:STATe]?

[SENSe:]{RESistance|FRESistance}:NULL:VALue {<value>|MIN|MAX|DEF}

[SENSe:]{RESistance|FRESistance}:NULL:VALue? [{MIN|MAX|DEF}]

[SENSe:]{RESistance|FRESistance}:NULL:VALue:AUTO {OFF|ON}

[SENSe:]{RESistance|FRESistance}:NULL:VALue:AUTO?

[SENSe:]{RESistance|FRESistance}:OCOMpensated {OFF|ON}

[SENSe:]{RESistance|FRESistance}:OCOMpensated?

[SENSe:]{RESistance|FRESistance}:POWer:LIMit[:STATe] {OFF|ON}

[SENSe:]{RESistance|FRESistance}:POWer:LIMit[:STATe]?

[SENSe:]{RESistance|FRESistance}:RANGe {<range>|MIN|MAX|DEF}

[SENSe:]{RESistance|FRESistance}:RANGe? [{MIN|MAX|DEF}]

[SENSe:]{RESistance|FRESistance}:RANGe:AUTO {OFF|ON|ONCE}

[SENSe:]{RESistance|FRESistance}:RANGe:AUTO?

[SENSe:]{RESistance|FRESistance}:RESolution {<resolution>|MIN|MAX|DEF}

[SENSe:]{RESistance|FRESistance}:RESolution? [{MIN|MAX|DEF}]

[SENSe:]{FRESistance|RESistance}:SECOndary {"OFF"|"CALCulate:DATA"}

[SENSe:]{FRESistance|RESistance}:SECOndary?

[SENSe:]RESistance:ZERO:AUTO {OFF|ON|ONCE}

[SENSe:]RESistance:ZERO:AUTO?

AC and DC Current Configuration Commands

CONFigure:CURRent:{AC|DC} [{<range>|AUTO|MIN|MAX|DEF} [, {<resolution>|MIN|MAX|DEF}]]

CONFigure?

[SENSe:]CURRent:AC:BANDwidth {<filter>|MIN|MAX|DEF}

[SENSe:]CURRent:AC:BANDwidth? [{MIN|MAX|DEF}]

[SENSe:]CURRent:{AC|DC}:NULL[:STATe] {OFF|ON}

[SENSe:]CURRent:{AC|DC}:NULL[:STATe]?

[SENSe:]CURRent:{AC|DC}:NULL:VALue {<value>|MIN|MAX|DEF}

[SENSe:]CURRent:{AC|DC}:NULL:VALue? [{MIN|MAX|DEF}]

[SENSe:]CURRent:{AC|DC}:NULL:VALue:AUTO {OFF|ON}

[SENSe:]CURRent:{AC|DC}:NULL:VALue:AUTO?

[SENSe:]CURRent:{AC|DC}:RANGe {<range>|MIN|MAX|DEF}

[SENSe:]CURRent:{AC|DC}:RANGe? [{MIN|MAX|DEF}]

[SENSe:]CURRent:{AC|DC}:RANGe:AUTO {OFF|ON|ONCE}

[SENSe:]CURRent:{AC|DC}:RANGe:AUTO?

[SENSe:]CURRent:{AC|DC}:TERMinals {3|10}

[SENSe:]CURRent:{AC|DC}:TERMinals?

[SENSe:]CURRent:AC:SECondary {"OFF"|"CALCulate:DATA"|"FREQuency"|"CURRent[:DC]"}]

[SENSe:]CURRent:AC:SECondary?

[SENSe:]CURRent[:DC]:APERture {<seconds>|MIN|MAX|DEF}

[SENSe:]CURRent[:DC]:APERture? [{MIN|MAX|DEF}]

[SENSe:]CURRent[:DC]:APERture:ENABled {OFF|ON}

[SENSe:]CURRent[:DC]:APERture:ENABled?

[SENSe:]CURRent[:DC]:NPLC {<PLCs>|MIN|MAX|DEF}

[SENSe:]CURRent[:DC]:NPLC? [{MIN|MAX|DEF}]

[SENSe:]CURRent[:DC]:RESolution {<resolution>|MIN|MAX|DEF}

[SENSe:]CURRent[:DC]:RESolution? [{MIN|MAX|DEF}]

[SENSe:]CURRent[:DC]:SECondary {"OFF"|"CALCulate:DATA"|"CURRent:AC"|"PTPeak"}

[SENSe:]CURRent[:DC]:SECondary?

[SENSe:]CURRent[:DC]:ZERO:AUTO {OFF|ON|ONCE}

[SENSe:]CURRent[:DC]:ZERO:AUTO?

[SENSe:]CURRent:SWITCh:MODE {FAST|CONTInuous}

[SENSe:]CURRent:SWITCh:MODE?

Capacitance Configuration Commands

```

CONFigure:CAPacitance [{<range>|AUTO|MIN|MAX|DEF} [, {<resolution>|MIN|MAX|DEF}]]
CONFigure?

[SENSe:]CAPacitance:NULL[:STATe] {OFF|ON}
[SENSe:]CAPacitance:NULL[:STATe]?

[SENSe:]CAPacitance:NULL:VALue {<value>|MIN|MAX|DEF}
[SENSe:]CAPacitance:NULL:VALue? [{MIN|MAX|DEF}]

[SENSe:]CAPacitance:NULL:VALue:AUTO {OFF|ON}
[SENSe:]CAPacitance:NULL:VALue:AUTO?

[SENSe:]CAPacitance:RANGe {<range>|MIN|MAX|DEF}
[SENSe:]CAPacitance:RANGe? [{MIN|MAX|DEF}]

[SENSe:]CAPacitance:RANGe:AUTO {OFF|ON|ONCE}
[SENSe:]CAPacitance:RANGe:AUTO?

[SENSe:]CAPacitance:SECondary{"OFF"|"CALCulate:DATA"}
[SENSe:]CAPacitance:SECondary?
    
```

Temperature Configuration Commands

```

CONFigure:TEMPerature [{FRTD|RTD|FTHermistor|THERmistor|TCouple|DEFAult} [, {<type>|DEFAult} [, 1 ,
{<resolution>|MIN|MAX|DEF}]]]]
CONFigure?

[SENSe:]TEMPerature:APERTure {<seconds>|MIN|MAX|DEF}
[SENSe:]TEMPerature:APERTure? [{MIN|MAX|DEF}]

[SENSe:]TEMPerature:APERTure:ENABled {OFF|ON}
[SENSe:]TEMPerature:APERTure:ENABled?

[SENSe:]TEMPerature:NPLC {<PLCs>|MIN|MAX|DEF}
[SENSe:]TEMPerature:NPLC? [{MIN|MAX|DEF}]

[SENSe:]TEMPerature:NULL[:STATe] {OFF|ON}
[SENSe:]TEMPerature:NULL[:STATe]?

[SENSe:]TEMPerature:NULL:VALue {<value>|MIN|MAX|DEF}
[SENSe:]TEMPerature:NULL:VALue? [{MIN|MAX|DEF}]

[SENSe:]TEMPerature:NULL:VALue:AUTO {OFF|ON}
[SENSe:]TEMPerature:NULL:VALue:AUTO?

[SENSe:]TEMPerature:SECondary {"OFF"|"CALCulate:DATA"|"SENSe:DATA"}
[SENSe:]TEMPerature:SECondary?

[SENSe:]TEMPerature:TRANSDucer:{FRTD|RTD}:OCOMpensated {OFF|ON}
[SENSe:]TEMPerature:TRANSDucer:{FRTD|RTD}:OCOMpensated?

[SENSe:]TEMPerature:TRANSDucer:{FRTD|RTD}:POWER:LIMit[:STATe] {OFF|ON}
[SENSe:]TEMPerature:TRANSDucer:{FRTD|RTD}:POWER:LIMit[:STATe]?

[SENSe:]TEMPerature:TRANSDucer:{FRTD|RTD}:RESistance[:REFerence] {<reference>|MIN|MAX|DEF}
[SENSe:]TEMPerature:TRANSDucer:{FRTD|RTD}:RESistance[:REFerence]? [{MIN|MAX|DEF}]

[SENSe:]TEMPerature:TRANSDucer:{FTHermistor|THERmistor}:POWER:LIMit[:STATe] {OFF|ON}
[SENSe:]TEMPerature:TRANSDucer:{FTHermistor|THERmistor}:POWER:LIMit[:STATe]?

[SENSe:]TEMPerature:TRANSDucer:TCouple:CHECK {OFF|ON}
[SENSe:]TEMPerature:TRANSDucer:TCouple:CHECK?
    
```

```
[SENSe:]TEMPerature:TRANsdUcer:TCouple:RJUNction {<temperature>|MIN|MAX|DEF}
[SENSe:]TEMPerature:TRANsdUcer:TCouple:RJUNction? [{MIN|MAX|DEF}]

[SENSe:]TEMPerature:TRANsdUcer:TCouple:RJUNction:OFFSet:ADJust {<temperature>|MIN|MAX|DEF}
[SENSe:]TEMPerature:TRANsdUcer:TCouple:RJUNction:OFFSet:ADJust? [{MIN|MAX|DEF}]

[SENSe:]TEMPerature:TRANsdUcer:TCouple:RJUNction:TYPE {INTernal|FIXed}
[SENSe:]TEMPerature:TRANsdUcer:TCouple:RJUNction:TYPE?

[SENSe:]TEMPerature:TRANsdUcer:TCouple:TYPE {E|J|K|N|R|T}
[SENSe:]TEMPerature:TRANsdUcer:TCouple:TYPE?

[SENSe:]TEMPerature:TRANsdUcer:TYPE {FRTD|RTD|FTHermistor|THERmistor|TCouple}
[SENSe:]TEMPerature:TRANsdUcer:TYPE?

[SENSe:]TEMPerature:ZERO:AUTO {OFF|ON|ONCE}
[SENSe:]TEMPerature:ZERO:AUTO?

UNIT:TEMPerature {C|F|K}
UNIT:TEMPerature?
```

Frequency/Period Configuration Commands

```
CONFigure:{FREQuency|PERiod} [{<range>|MIN|MAX|DEF} [, {<resolution>|MIN|MAX|DEF}]]
CONFigure?

[SENSe:]{FREQuency|PERiod}:APERTure {<seconds>|MIN|MAX|DEF}
[SENSe:]{FREQuency|PERiod}:APERTure? [{MIN|MAX|DEF}]

[SENSe:]{FREQuency|PERiod}:NULL[:STATe] {OFF|ON}
[SENSe:]{FREQuency|PERiod}:NULL[:STATe]?

[SENSe:]{FREQuency|PERiod}:NULL:VALue {<value>|MIN|MAX|DEF}
[SENSe:]{FREQuency|PERiod}:NULL:VALue? [{MIN|MAX|DEF}]

[SENSe:]{FREQuency|PERiod}:NULL:VALue:AUTO {OFF|ON}
[SENSe:]{FREQuency|PERiod}:NULL:VALue:AUTO?

[SENSe:]{FREQuency|PERiod}:RANGe:LOWer {<freq>|MIN|MAX|DEF}
[SENSe:]{FREQuency|PERiod}:RANGe:LOWer?

[SENSe:]{FREQuency|PERiod}:TIMEout:AUTO {OFF|ON}

[SENSe:]{FREQuency|PERiod}:VOLTage:RANGe {<range>|MIN|MAX|DEF}
[SENSe:]{FREQuency|PERiod}:VOLTage:RANGe? [{MIN|MAX|DEF}]

[SENSe:]{FREQuency|PERiod}:VOLTage:RANGe:AUTO {OFF|ON|ONCE}
[SENSe:]{FREQuency|PERiod}:VOLTage:RANGe:AUTO?

[SENSe:]FREQuency:SECondary {"OFF"|"CALCulate:DATA"|"PERiod"|"VOLTage:AC"}
[SENSe:]FREQuency:SECondary?

[SENSe:]PERiod:SECondary {"OFF"|"CALCulate:DATA"|"FREQuency"|"VOLTage:AC"}
[SENSe:]PERiod:SECondary?
```

Continuity and Diode Configuration Commands

```
CONFigure:CONTInuity
CONFigure:DIODE
```

Secondary Measurement Commands

```
[SENSe:]CAPacitance:SECondary {"OFF"|"CALCulate:DATA"}
[SENSe:]CAPacitance:SECondary?

[SENSe:]CURRent:AC:SECondary {"OFF"|"CALCulate:DATA"|"FREQuency"|"CURRent[:DC]"}
[SENSe:]CURRent:AC:SECondary?

[SENSe:]CURRent[:DC]:SECondary {"OFF"|"CALCulate:DATA"|"CURRent:AC"|"PTPeak"}
[SENSe:]CURRent[:DC]:SECondary?

[SENSe:]DATA2?

[SENSe:]DATA2:CLEar[:IMMediate]

[SENSe:]{FREStance|RESistance}:SECondary {"OFF"|"CALCulate:DATA"}
[SENSe:]{FREStance|RESistance}:SECondary?

[SENSe:]FREQuency:SECondary {"OFF"|"CALCulate:DATA"|"PERiod"|"VOLTage:AC"}
[SENSe:]PERiod:SECondary {"OFF"|"CALCulate:DATA"|"FREQuency"|"VOLTage:AC"}

[SENSe:]TEMPerature:SECondary {"OFF"|"CALCulate:DATA"|"SENSe:DATA"}
[SENSe:]TEMPerature:SECondary?

[SENSe:]VOLTage:AC:SECondary {"OFF"|"CALCulate:DATA"|"FREQuency"|"VOLTage[:DC]"}
[SENSe:]VOLTage:AC:SECondary?

[SENSe:]VOLTage[:DC]:RATio:SECondary {"OFF"|"CALCulate:DATA"|"SENSe:DATA"}
[SENSe:]VOLTage[:DC]:RATio:SECondary?

[SENSe:]VOLTage[:DC]:SECondary {"OFF"|"CALCulate:DATA"|"VOLTage:AC"|"PTPeak"}
[SENSe:]VOLTage[:DC]:SECondary?
```

Miscellaneous Configuration Commands

```
ROUTe:TERMinals?
```

Sample Commands

```

SAMPLE:COUNT {<count>|MIN|MAX|DEF}
SAMPLE:COUNT? [{MIN|MAX|DEF}]

SAMPLE:COUNT:PRETrigger {<count>|MIN|MAX|DEF}
SAMPLE:COUNT:PRETrigger? [{MIN|MAX|DEF}]

SAMPLE:SOURce {IMMediate|TImEr}
SAMPLE:SOURce?

SAMPLE:TImEr {<interval>|MIN|MAX|DEF}
SAMPLE:TImEr? [{MIN|MAX|DEF}]

```

Triggering Commands

```

ABORt

INITiate[:IMMediate]

OUTPut:TRIGger:SLOPe {POSitive|NEGative}
OUTPut:TRIGger:SLOPe?

READ?

SAMPLE:COUNT {<count>|MIN|MAX|DEF}
SAMPLE:COUNT? [{MIN|MAX|DEF}]

SAMPLE:COUNT:PRETrigger {<count>|MIN|MAX|DEF}
SAMPLE:COUNT:PRETrigger? [{MIN|MAX|DEF}]

*TRG

TRIGger:COUNT {<count>|MIN|MAX|DEF|INFinity}
TRIGger:COUNT? [{MIN|MAX|DEF}]

TRIGger:DELAy {<seconds>|MIN|MAX|DEF}
TRIGger:DELAy? [{MIN|MAX|DEF}]

TRIGger:DELAy:AUTO {OFF|ON}
TRIGger:DELAy:AUTO?

TRIGger:LEVel {<level>|MIN|MAX|DEF}
TRIGger:LEVel? [{MIN|MAX|DEF}]

TRIGger:SLOPe {POSitive|NEGative}
TRIGger:SLOPe?

TRIGger:SOURce {IMMediate|EXTErnal|BUS|INTErnal}
TRIGger:SOURce?

```

Calculation (Math) Commands

Overall

CALCulate:CLEar[:IMMediate]

Histogram

CALCulate:TRANSform:HISTogram:ALL?

CALCulate:TRANSform:HISTogram:CLEar[:IMMediate]

CALCulate:TRANSform:HISTogram:COUNT?

CALCulate:TRANSform:HISTogram:DATA?

CALCulate:TRANSform:HISTogram:POINTs {<value>|MIN|MAX|DEF}

CALCulate:TRANSform:HISTogram:POINTs? [{MIN|MAX|DEF}]

CALCulate:TRANSform:HISTogram:RANGe:AUTO {OFF|ON}

CALCulate:TRANSform:HISTogram:RANGe:AUTO?

CALCulate:TRANSform:HISTogram:RANGe:{LOWer|UPPer} {<value>|MIN|MAX|DEF}

CALCulate:TRANSform:HISTogram:RANGe:{LOWer|UPPer}? [{MIN|MAX|DEF}]

CALCulate:TRANSform:HISTogram[:STATe] {OFF|ON}

CALCulate:TRANSform:HISTogram[:STATe]?

Limit Testing

CALCulate:LIMit:CLEar[:IMMediate]

CALCulate:LIMit:{LOWer|UPPer}[:DATA] {<value>|MIN|MAX|DEF}

CALCulate:LIMit:{LOWer|UPPer}[:DATA]? [{MIN|MAX|DEF}]

CALCulate:LIMit[:STATe] {OFF|ON}

CALCulate:LIMit[:STATe]?

Scaling

CALCulate:SCALE:DB:REfERENCE {<reference>|MIN|MAX|DEF}
 CALCulate:SCALE:DB:REfERENCE? [{MIN|MAX|DEF}]

CALCulate:SCALE:DBM:REfERENCE {<reference>|MIN|MAX|DEF}
 CALCulate:SCALE:DBM:REfERENCE? [{MIN|MAX|DEF}]

CALCulate:SCALE:FUNcTION {DB|DBM|PCT|SCALE}
 CALCulate:SCALE:FUNcTION?

CALCulate:SCALE:GAIn {<gain>|MIN|MAX|DEF}
 CALCulate:SCALE:GAIn? [{MIN|MAX|DEF}]

CALCulate:SCALE:OFFSet {<offset>|MIN|MAX|DEF}
 CALCulate:SCALE:OFFSet? [{MIN|MAX|DEF}]

CALCulate:SCALE:REfERENCE:AUTO {OFF|ON}
 CALCulate:SCALE:REfERENCE:AUTO?

CALCulate:SCALE:REfERENCE {<reference>|MIN|MAX|DEF}
 CALCulate:SCALE:REfERENCE? [{MIN|MAX|DEF}]

CALCulate:SCALE[:STATe] {OFF|ON}
 CALCulate:SCALE[:STATe]?

CALCulate:SCALE:UNIT <quoted_string>
 CALCulate:SCALE:UNIT?

CALCulate:SCALE:UNIT:STATe {OFF|ON}
 CALCulate:SCALE:UNIT:STATe?

Statistics

CALCulate:AVERage:ALL?

CALCulate:AVERage:AVERage?

CALCulate:AVERage:CLEar[:IMMEDIATE]

CALCulate:AVERage:COUNT?

CALCulate:AVERage:MAXimum?

CALCulate:AVERage:MINimum?

CALCulate:AVERage:PTPeak?

CALCulate:AVERage:SDEVIation?

CALCulate:AVERage[:STATe] {OFF|ON}

CALCulate:AVERage[:STATe]?

Smoothing

CALCulate:SMOothing:RESPonse {SLOW|MEDIUM|FAST}

CALCulate:SMOothing:RESPonse?

CALCulate:SMOothing[:STATe] {OFF|ON}

CALCulate:SMOothing[:STATe]?

Trend Chart

CALCulate:TCHart[:STATe] {OFF|ON}

CALCulate:TCHart[:STATe]?

Reading Memory Commands

DATA:LAST?

DATA:POINts:EVENT:THReshold <count>

DATA:POINts:EVENT:THReshold?

DATA:POINts?

DATA:REMOve? <num_readings> [,WAIT]

FETCH?

R? [<max_readings>]

Calibration Commands

*CAL?

CALibration:ADC?

CALibration[:ALL]?

CALibration:COUNT?

CALibration:DATE?

CALibration:SECure:CODE <*new_code*>

CALibration:SECure:STATe {OFF|ON} [, <*code*>]

CALibration:SECure:STATe?

CALibration:STORe

CALibration:STRing "<*string*>"

CALibration:STRing?

CALibration:TEMPerature?

CALibration:TIME?

CALibration:VALue <*value*>

CALibration:VALue?

SYSTem:ACALibration:DATE?

SYSTem:ACALibration:TEMPerature?

SYSTem:ACALibration:TIME?

State Storage and Preferences Commands

*LRN?

MMEMory:LOAD:PREFerences <*file*>

MMEMory:LOAD:STATe <*file*>

MMEMory:STORe:PREFerences <*file*>

MMEMory:STORe:STATe <*file*>

MMEMory:STATe:RECall:AUTO {OFF|ON}

MMEMory:STATe:RECall:AUTO?

MMEMory:STATe:RECall:SElect <*file*>

MMEMory:STATe:RECall:SElect?

MMEMory:STATe:VALid? <*file*>

*RCL {0|1|2|3|4}

*SAV {0|1|2|3|4}

General Purpose File Management Commands

MMEemory:CATalog[:ALL]? [*<folder>* [*<filespec>*]]

MMEemory:CDIRectory *<folder>*

MMEemory:CDIRectory?

MMEemory:COPY *<file1>*, *<file2>*

MMEemory:DElete {*<file>*|*<filespec>*}

MMEemory:MDIRectory *<folder>*

MMEemory:MOVE *<file1>*, *<file2>*

MMEemory:RDIRectory *<folder>*

Data Transfer Commands

MMEemory:DOWNload:DATA <*binary_block*>
 MMEemory:DOWNload:FNAME <*file*>
 MMEemory:DOWNload:FNAME?
 MMEemory:FORMat:READing:CSEParator {COMMa|SEMicolon|TAB}
 MMEemory:FORMat:READing:CSEParator?
 MMEemory:FORMat:READing:INFormation {OFF|ON}
 MMEemory:FORMat:READing:INFormation?
 MMEemory:FORMat:READing:RLIMit {OFF|ON}
 MMEemory:FORMat:READing:RLIMit?
 MMEemory:STORe:DATA RDG_STORE, <*file*>
 MMEemory:UPLoad? <*file*>

IEEE-488 Commands

*CAL?
 *CLS
 *ESE <*enable_value*>
 *ESE?
 *ESR?
 *IDN?
 *LRN?
 *OPC
 *OPC?
 *OPT?
 *PSC {0|1}
 *PSC?
 *RCL {0|1|2|3|4}
 *RST
 *SAV {0|1|2|3|4}
 *SRE <*enable_value*>
 *SRE?
 *STB?
 *TRG
 *TST?
 *WAI

Format Subsystem

FORMat:BORDER {NORMal|SWAPped}
 FORMat:BORDER?

FORMat[:DATA] {ASCIi|REAL} [, <length>
 FORMat[:DATA]?

System-Related Commands

*CAL?

DISPlay[:STATe] {OFF|ON}
 DISPlay[:STATe]?

DISPlay:TEXT:CLEar

DISPlay:TEXT[:DATA] "<string>"
 DISPlay:TEXT[:DATA]?

DISPlay:VIEW {NUMeric|HISTogram|TCHart|METER}
 DISPlay:VIEW?

HCOPY:SDUMp:DATA:FORMat {PNG|BMP}
 HCOPY:SDUMp:DATA:FORMat?

HCOPY:SDUMp:DATA?

*IDN?

LXI:IDENtify[:STATe] {OFF|ON}
 LXI:IDENtify[:STATe]?

LXI:MDNS:ENABle {OFF|ON}
 LXI:MDNS:ENABle?

LXI:MDNS:HNAME[:RESolved]?

LXI:MDNS:SNAME:DESired "<name>"
 LXI:MDNS:SNAME:DESired?

LXI:MDNS:SNAME[:RESolved]?

LXI:RESet

LXI:REStart

*RST

SYSTem:ACALibration:DATE?

SYSTem:ACALibration:TEMPerature?

SYSTem:ACALibration:TIME?

SYSTem:BEEPer[:IMMediate]

SYSTem:BEEPer:STATe {OFF|ON}
 SYSTem:BEEPer:STATe?

SYSTem:CLICk:STATe {OFF|ON}
 SYSTem:CLICk:STATe?

SYSTem:DATE <year>, <month>, <day>
 SYSTem:DATE?

SYSTem:ERRor[:NEXT]?
 SYSTem:HELP?
 SYSTem:IDENtify {DEFault|AT34460A|AT34461A|AT34410A|AT34411A|HP34401A}
 SYSTem:IDENtify?
 SYSTem:LABel "<string>"
 SYSTem:LABel?
 SYSTem:LFRequency?
 SYSTem:LOCal
 SYSTem:PRESet
 SYSTem:SECurity:COUNT?
 SYSTem:SECurity:IMMediate
 SYSTem:TEMPerature?
 SYSTem:TIME <hour>, <minute>, <second>
 SYSTem:TIME?
 SYSTem:UPTime?
 SYSTem:USB:HOST:ENABLE {OFF|ON}
 SYSTem:USB:HOST:ENABLE?
 SYSTem:VERSion?
 SYSTem:WMESsage "<string>"
 SYSTem:WMESsage?
 TEST:ALL?
 *TST?

Parameters vary by DMM model number. See **SYSTem:IDENtify for details.*

Interface Locking Commands

SYSTem:LOCK:NAME?
 SYSTem:LOCK:OWNer?
 SYSTem:LOCK:RELease
 SYSTem:LOCK:REQuest?

License Management Commands

```

SYSTEM:LICense:CATalog?
SYSTEM:LICense:DELeTe "<option_name>"
SYSTEM:LICense:DELeTe:ALL
SYSTEM:LICense:DESCription? "<option_name>"
SYSTEM:LICense:ERRor?
SYSTEM:LICense:ERRor:COUnT?
SYSTEM:LICense:INSTall [{<folder>|<file>}]
SYSTEM:LICense:INSTall? "<option_name>"
    
```

Interface Configuration Commands

```

SYSTEM:COMMunicate:ENABle {OFF|ON}, {GPIB|HISLip|USB|LAN|SOCKets|TELNet|VXI11|WEB|USBMtp|USBHost}
SYSTEM:COMMunicate:ENABle? {GPIB|HISLip|USB|LAN|SOCKets|TELNet|VXI11|WEB|USBMtp|USBHost}

SYSTEM:COMMunicate:GPIB:ADDRes <address>
SYSTEM:COMMunicate:GPIB:ADDRes?

SYSTEM:COMMunicate:LAN:CONTRol?

SYSTEM:COMMunicate:LAN:DHCP {OFF|ON}
SYSTEM:COMMunicate:LAN:DHCP?

SYSTEM:COMMunicate:LAN:DNS[{{1|2}}] "<address>"
SYSTEM:COMMunicate:LAN:DNS[{{1|2}}]? [{{CURRent|STATic}}]

SYSTEM:COMMunicate:LAN:DOMain?

SYSTEM:COMMunicate:LAN:GATeway "<address>"
SYSTEM:COMMunicate:LAN:GATeway? [{{CURRent|STATic}}]

SYSTEM:COMMunicate:LAN:HOSTname "<name>"
SYSTEM:COMMunicate:LAN:HOSTname? [{{CURRent|STATic}}]

SYSTEM:COMMunicate:LAN:IPADdress "<address>"
SYSTEM:COMMunicate:LAN:IPADdress? [{{CURRent|STATic}}]

SYSTEM:COMMunicate:LAN:MAC?

SYSTEM:COMMunicate:LAN:SMASK "<mask>"
SYSTEM:COMMunicate:LAN:SMASK? [{{CURRent|STATic}}]

SYSTEM:COMMunicate:LAN:TELNet:PRoMpt "<string>"
SYSTEM:COMMunicate:LAN:TELNet:PRoMpt?

SYSTEM:COMMunicate:LAN:TELNet:WMESsage "<string>"
SYSTEM:COMMunicate:LAN:TELNet:WMESsage?

SYSTEM:COMMunicate:LAN:UPDate

SYSTEM:COMMunicate:LAN:WINS[{{1|2}}] "<address>"
SYSTEM:COMMunicate:LAN:WINS[{{1|2}}]? [{{CURRent|STATic}}]

SYSTEM:USB:HOST:ENABle {OFF|ON}
SYSTEM:USB:HOST:ENABle?
    
```

Status System Commands

*CLS

*ESE <enable_value>

*ESE?

*ESR?

*PSC {0|1}

*PSC?

*SRE <enable_value>

*SRE?

STATus:OPERation:CONDition?

STATus:OPERation:ENABLE <enable_value>

STATus:OPERation:ENABLE?

STATus:OPERation[:EVENT]?

STATus:PRESet

STATus:QUEStionable:CONDition?

STATus:QUEStionable:ENABLE <enable_value>

STATus:QUEStionable:ENABLE?

STATus:QUEStionable[:EVENT]?

*STB?

Range, Resolution and Integration Time (shown in Aperture and NPLCs)

The following three tables show the integration time (in PLC and seconds) for each range and resolution.

To determine the PLC for a specified range and resolution:

1. Locate the range in the left column. Measurement units do not apply (i.e. for 1 V or 1 A, use the 1 range; for 100 V or 100 Ω, use the 100 range).
2. From the range value, follow the corresponding row of resolutions to the right until the specified resolution lies within two adjacent columns for your DMM model.
3. The NPLC value at the top of the left-adjacent column is the NPLC "setting" for the given range and resolution.

For example: for the 34461A, a specified 10 VDC range and 10 μV resolution, locate range 10 in the table. Moving to the right, the 10 μV resolution (1E-5) is found in the column under 10 NPLC.

Model	34460A					34461A				
PLC	100	10	1	0.2	0.02	100	10	1	0.2	0.02
Aperture (60 Hz Power)	1.67s	0.167s	16.7ms	3ms	0.3ms	1.67s	0.167s	16.7ms	3ms	0.3ms
Aperture (50 Hz Power)	2s	0.2s	20ms			2s	0.2s	20ms		
ResFactor ¹	3ppm	10ppm	30ppm	100ppm	300ppm	0.3ppm	1ppm	3ppm	10ppm	100ppm
Range	Resolution									
1 m	3E-9	1E-8	3E-8	1E-7	3E-7	3E-10	1E-9	3E-9	1E-8	1E-7
10 m	3E-8	1E-7	3E-7	1E-6	3E-6	3E-9	1E-8	3E-8	1E-7	1E-6
100 m	3E-7	1E-6	3E-6	1E-5	3E-5	3E-8	1E-7	3E-7	1E-6	1E-5
1	3E-6	1E-5	3E-5	1E-4	3E-4	3E-7	1E-6	3E-6	1E-5	1E-4
10	3E-5	1E-4	3E-4	1E-3	3E-3	3E-6	1E-5	3E-5	1E-4	1E-3
100	3E-4	1E-3	3E-3	1E-2	3E-2	3E-5	1E-4	3E-4	1E-3	1E-2
1 k	3E-3	1E-2	3E-2	1E-1	3E-1	3E-4	1E-3	3E-3	1E-2	1E-1
10 k	3E-2	1E-1	3E-1	1	3	3E-3	1E-2	3E-2	1E-1	1
100 k	3E-1	1	3	10	30	3E-2	1E-1	3E-1	1	10
1 M	3	10	30	100	300	3E-1	1	3	10	100
10 M	30	100	300	1 k	3 k	3	10	30	100	1 k
100 M	300	1 k	3 k	10 k	30 k	30	100	300	1 k	10 k

¹ResFactor x Range = Resolution.

Model	34465A								
PLC	100	10	1	0.2	0.06	0.02	0.006 ²	0.002 ²	0.001 ²
Aperture (60 Hz Power)	1.67s	0.167s	16.7ms	3ms	1ms	0.3ms	100 μs ²	40 μs ²	20 μs ²
Aperture (50 Hz Power)	2s	0.2s	20ms						
ResFactor ¹	0.03 ppm	0.1 ppm	0.3 ppm	0.7 ppm	1.5 ppm	3 ppm	6 ppm	15 ppm	30 ppm
Range	Resolution								
1 m	30E-12	100E-12	300E-12	700E-12	1.5E-9	3E-9	6E-9	15E-9	30E-9
10 m	300E-12	1E-9	3E-9	7E-9	1.5E-8	3E-8	6E-8	15E-8	30E-8
100 m	3E-9	1E-8	3E-8	7E-8	1.5E-7	3E-7	6E-7	15E-7	30E-7
1	3E-8	1E-7	3E-7	7E-7	1.5E-6	3E-6	6E-6	15E-6	30E-6
10	3E-7	1E-6	3E-6	7E-6	1.5E-5	3E-5	6E-5	15E-5	30E-5
100	3E-6	1E-5	3E-5	7E-5	1.5E-4	3E-4	6E-4	15E-4	30E-4
1 k	3E-5	1E-4	3E-4	7E-4	1.5E-3	3E-3	6E-3	15E-3	30E-3
10 k	3E-4	1E-3	3E-3	7E-3	1.5E-2	3E-2	6E-2	15E-2	30E-2
100 k	3E-3	1E-2	3E-2	7E-2	1.5E-1	3E-1	6E-1	15E-1	30E-1
1 M	3E-2	1E-1	3E-1	7E-1	1.5	3	6	15	30
10 M	3E-1	1	3	7	15	30	60	150	300
100 M	3	10	30	70	150	300	600	1.5 k	3 k
1 G	30	100	300	700	1.5 k	3 k	6 k	15 k	30 k

Model	34470A								
PLC	100	10	1	0.2	0.06	0.02	0.006 ²	0.002 ²	0.001 ²
Aperture (60 Hz Power)	1.67s	0.167s	16.7ms	3ms	1ms	0.3ms	100 μs ²	40 μs ²	20 μs ²
Aperture (50 Hz Power)	2s	0.2s	20ms						
ResFactor ¹	0.01 ppm	0.03 ppm	0.1 ppm	0.3 ppm	0.5 ppm	1 ppm	3 ppm	10 ppm	30 ppm
Range	Resolution								
1 m	10E-12	30E-12	100E-12	300E-12	500E-12	1E-9	3E-9	10E-9	30E-9
10 m	100E-12	300E-12	1E-9	3E-9	5E-9	1E-8	3E-8	10E-8	30E-8
100 m	1E-9	3E-9	1E-8	3E-8	5E-8	1E-7	3E-7	10E-7	30E-7
1	1E-8	3E-8	1E-7	3E-7	5E-7	1E-6	3E-6	10E-6	30E-6
10	1E-7	3E-7	1E-6	3E-6	5E-6	1E-5	3E-5	10E-5	30E-5
100	1E-6	3E-6	1E-5	3E-5	5E-5	1E-4	3E-4	10E-4	30E-4
1 k	1E-5	3E-5	1E-4	3E-4	5E-4	1E-3	3E-3	10E-3	30E-3
10 k	1E-4	3E-4	1E-3	3E-3	5E-3	1E-2	3E-2	10E-2	30E-2
100 k	1E-3	3E-3	1E-2	3E-2	5E-2	1E-1	3E-1	10E-1	30E-1
1 M	1E-2	3E-2	1E-1	3E-1	5E-1	1	3	10	30
10 M	1E-1	3E-1	1	3	5	10	30	100	300
100 M	1	3	10	30	50	100	300	1 k	3 k
1 G	10	30	100	300	500	1 k	3 k	10 k	30 k

SCPI Programming Reference

¹*ResFactor x Range = Resolution.*, ² *34465A/70A with DIG option only.*

Resolution and Integration Time for DC Measurements

Setting the integration time also sets the measurement resolution. This table shows the relationship between integration time in power line cycles (PLC) and resolution.

Integration Time			Resolution (34460A)	Resolution (34461A)	Resolution (34465A)	Resolution (34470A)
Power Line Cycles	Aperture (60 Hz Power)	Aperture (50 Hz Power)				
0.001 PLC ¹	20 μ s ¹		-	-	30 ppm x Range	30 ppm x Range
0.002 PLC ¹	40 μ s ¹		-	-	15 ppm x Range	10 ppm x Range
0.006 PLC ¹	100 μ s ¹		-	-	6 ppm x Range	3 ppm x Range
0.02 PLC (MINimum)	0.3 ms		300 ppm x Range (MAXimum)	100 ppm x Range (MAXimum)	3 ppm x Range	1 ppm x Range
0.06 PLC	1 ms		-	-	1.5 ppm x Range	0.5 ppm x Range
0.2 PLC	3 ms		100 ppm x Range	10 ppm x Range	0.7 ppm x Range	0.3 ppm x Range
1 PLC	16.7 ms	20 ms	30 ppm x Range	3 ppm x Range	0.3 ppm x Range	0.1 ppm x Range
10 PLC (DEFault)	0.167 s	0.2 s	10 ppm x Range (DEFault)	1 ppm x Range (DEFault)	0.1 ppm x Range	0.03 ppm x Range
100 PLC (MAXimum)	1.67 s	2 s	3 ppm x Range (MINimum)	0.3 ppm x Range (MINimum)	0.03 ppm x Range	0.01 ppm x Range

¹34465A/70A with DIG option only.

Automatic Trigger Delays

If TRIGger:DElay:AUTO is on, the instrument selects the trigger delay for you, as shown in the tables below.

NOTE All frequency and period measurements have an automatic trigger delay of 1 second.

The continuity and diode functions ignore the trigger delay.

The 2-wire and 4-wire temperature measurements use the corresponding 2-wire and 4-wire resistance measurement delays.

DC Voltage Default Delays

PLC	0.001 ¹	0.002 ¹	0.006 ¹	0.02	0.06 ²	0.2	1	10	100
Aperture (60 Hz Power)	20 μ s ¹	40 μ s ¹	100 μ s ¹	0.3 ms	1 ms ²	3 ms	16.7 ms	0.167 s	1.67 s
Aperture (50 Hz Power)							20 ms	0.2 s	2 s
Range	Delay								
All	100 μ s			130 μ s		160 μ s			

¹ 34465A/70A with DIG option only.

² 34465A/70A only.

DC Current Default Delays

PLC	0.001 ¹	0.002 ¹	0.006 ¹	0.02	0.06 ²	0.2	1	10	100
Aperture (60 Hz Power)	20 μ s ¹	40 μ s ¹	100 μ s ¹	0.3 ms	1 ms ²	3 ms	16.7 ms	0.167 s	1.67 s
Aperture (50 Hz Power)							20 ms	0.2 s	2 s
Range	Delay								
All	1 ms					1.5 ms			

¹ 34465A/70A with DIG option only.

² 34465A/70A only.

Resistance (2-wire) Default Delays

PLC	0.001 ¹	0.002 ¹	0.006 ¹	0.02	0.06 ²	0.2	1	10	100
Aperture (60 Hz Power)	20 μ s ¹	40 μ s ¹	100 μ s ¹	0.3 ms	1 ms ²	3 ms	16.7 ms	0.167 s	1.67 s
Aperture (50 Hz Power)							20 ms	0.2 s	2 s
Range	Delay								
100 Ω	80 μ s			100 μ s		130 μ s			
1 k Ω	110 μ s			130 μ s		160 μ s			
10 k Ω	130 μ s			160 μ s		190 μ s			
100 k Ω	540 μ s			670 μ s		800 μ s			
1 M Ω	5 ms			6 ms		7.5 ms			
10 M Ω	60 ms			70 ms		84 ms			
100 M Ω									
1 G Ω ²									

¹ 34465A/70A with DIG option only.

² 34465A/70A only.

Resistance (4-wire) Default Delays

PLC	0.001 ¹	0.002 ¹	0.006 ¹	0.02	0.06 ²	0.2	1	10	100
Aperture (60 Hz Power)	20 μ s ¹	40 μ s ¹	100 μ s ¹	0.3 ms	1 ms ²	3 ms	16.7 ms	0.167 s	1.67 s
Aperture (50 Hz Power)							20 ms	0.2 s	2 s
Range	Delay								
100 Ω	1 ms					1.5 ms			
1 k Ω									
10 k Ω									
100 k Ω									
1 M Ω	10 ms					15 ms			
10 M Ω	100 ms								
100 M Ω									
1 G Ω ²									

¹ 34465A/70A with DIG option only.

² 34465A/70A only.

AC Voltage Default Delays

Range	Filter (Hz)		
	3	20	200
All	2.5 s	0.625 s	0.025 s

AC Current Default Delays

	Filter (Hz)		
Range	3	20	200
All	1.66 s	0.25 s	0.025 s

Frequency and Period

The default delay for frequency and period is 1 s, regardless of aperture (gate time) setting.

VM Comp Output (BNC)

The rear-panel VM Comp (voltmeter complete) output provides a 3.3 V pulse after each measurement completion to implement a standard hardware handshake sequence between measurement and switching devices.

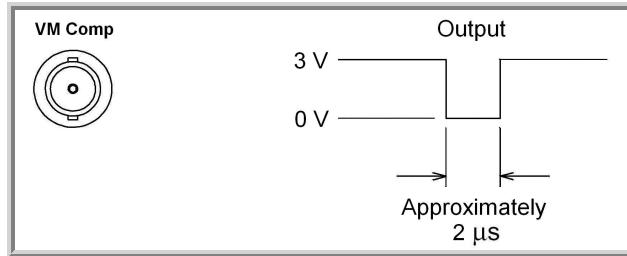

The signal shown is for a negative pulse.

SCPI Error Messages

Command Errors (-100...)

Execution Errors (-200...)

Device-Specific Errors (-300...)

Query Errors (-400...)

Network Errors (+100...)

Instrument Errors (+200...)

Miscellaneous Errors (+300... and +500..)

Licensing and Self-test Errors (+600...)

Calibration Errors (+700...)

Miscellaneous Errors (+800...)

The instrument returns error messages in accordance with the SCPI standard.

- Up to 20 errors can be stored in the instrument's error queue. Each remote interface I/O session (GPIB, USB, VXI-11, Telnet/Sockets) has its own interface-specific error queue. Errors appear in the error queue of the I/O session that caused the error. For example, if an error was generated by a command sent over GPIB, send **SYSTem:ERRor?** from GPIB to read the error queue. Errors generated by instrument hardware are broadcast to all I/O sessions.
- The instrument beeps each time an error is generated (unless disabled by **SYSTem:BEEPer:STATe OFF**). The front panel **Error** annunciator turns on when one or more errors are in the error queue.
- A special global error queue holds all power-on and hardware-related errors (for example, over-temperature).
- Error retrieval is first-in-first-out (FIFO), and errors are cleared as you read them. When you have read all of the interface-specific errors, the errors in the global error queue are retrieved. When you have read all errors from the interface-specific and global error queues, the **Error** annunciator turns off.
- If more than 20 errors have occurred, the most recent error stored in the queue is replaced with -350, "Queue overflow". No additional errors are stored until you remove errors from the queue. If no errors have occurred when you read the error queue, the instrument responds with +0, "No error".
- The front panel reports errors from all I/O sessions and the global error queue. To read the error queue from the front panel, press **Help > View remote command error queue**.
- Error conditions are also summarized in the Status Byte Register. For more information on the SCPI Status System, see **Status Subsystem Introduction**.
- The interface-specific error queues are cleared by the ***CLS** (Clear Status) command and when power is cycled. All errors are cleared when you read the error queue. The error queue is not cleared by a Factory Reset (***RST**) or an Instrument Preset (**SYSTem:PRESet**).

- **Front Panel:**

If the **Error** annunciator is on, there are errors in the error queue. The **Remote** annunciator is likely on as well. Press the **Local** key to return to local operation (the **Remote** annunciator goes off). Then press **[Help]**, select "View remote command error queue" in the menu and press **Select**. Use the menu navigation "arrow" keys to view the error messages. Press **Back** to exit and clear the error queue.

- **SCPI:**

SYSTEM:ERRor? Read and clear one error from the queue

Errors have the following format (the error string may contain up to 80 characters):

-113, "Undefined header"

Command Errors (-100...)

- 100,"Command error"
- 101,"Invalid character"
- 102,"Syntax error"
- 103,"Invalid separator"
- 104,"Data type error"
- 105,"GET not allowed"
- 108,"Parameter not allowed"
- 109,"Missing parameter"
- 110,"Command header error"
- 111,"Header separator error"
- 112,"Program mnemonic too long"
- 113,"Undefined header"
- 114,"Header suffix out of range"
- 120,"Numeric data error"
- 121,"Invalid character in number"
- 123,"Exponent too large"
- 123,"Numeric overflow"
- 124,"Too many digits"
- 128,"Numeric data not allowed"
- 130,"Suffix error"
- 131,"Invalid suffix"
- 134,"Suffix too long"
- 138,"Suffix not allowed"
- 140,"Character data error"
- 141,"Invalid character data"
- 144,"Character data too long"
- 148,"Character data not allowed"
- 150,"String data error"
- 151,"Invalid string data"
- 158,"String data not allowed"

-160,"Block data error"

-161,"Invalid block data"

-168,"Block data not allowed"

Execution Errors (-200...)

- 203,"Command protected"
- 203,"Command protected; feature not available on this model"
- 203,"Command protected; instrument must be unsecured"
- 203,"Command protected; large memory requires license MEM"
- 203,"Command protected; License required"
- 203,"Command protected; requires license DIG"
- 203,"Command protected; requires license LAN"
- 203,"Command protected; requires license SEC"
- 203,"Secure option: Instrument security is unlocked"
- 210,"Trigger error"
- 211,"Trigger ignored"
- 213,"Init ignored"
- 214,"Trigger deadlock"
- 220,"Parameter error"
- 221,"Settings conflict"
- 221,"Settings conflict; *TRG when TRIG:SOUR BUS not selected; trigger ignored"
- 221,"Settings conflict; 10A current terminals not available with rear terminals; terminals set to 3A"
- 221,"Settings conflict; CALC not allowed in current measurement function; CALC:STAT OFF set"
- 221,"Settings conflict; CALC:SCAL:REF 0.0 not compatible with CALC:SCAL:FUNC PCT; CALC:SCAL:STATE OFF set"
- 221,"Settings conflict; cannot delete state selected and enabled for automatic power-on recall"
- 221,"Settings conflict; cannot meet requested timing; SAMP:TIM changed"
- 221,"Settings conflict; cannot meet requested timing; TRIG:DEL changed"
- 221,"Settings conflict; histogram lower range > upper range; CALC:TRAN:HIST:RANG:AUTO ON set"
- 221,"Settings conflict; histogram not allowed in current measurement function; CALC:TRAN:HIST:STAT OFF set"
- 221,"Settings conflict; internal trigger not allowed in current measurement function; TRIG:SOUR IMM selected"
- 221,"Settings conflict; limit test not allowed in current measurement function; CALC:LIM:STAT OFF set"
- 221,"Settings conflict; lower limit > upper limit; CALC:LIM:UPP set to CALC:LIM:LOW value"
- 221,"Settings conflict; offset compensation not allowed with low power ohms; low power disabled"

- 221,"Settings conflict; pretrigger count limited to 10,000 with CALC enabled; SAMP:COUN:PRET changed"
- 221,"Settings conflict; pretrigger not supported on current measurement function; SAMP:COUN:PRET 0 set"
- 221,"Settings conflict; pretrigger SAMP:COUN:PRETrig >= SAMP:COUN; SAMP:COUN:PRET changed"
- 221,"Settings conflict; SAMP:COUN limited to memory size in pretrigger mode; SAMP:COUN changed"
- 221,"Settings conflict; scaling not allowed in current measurement function; CALC:SCAL:STAT OFF set"
- 221,"Settings conflict; smoothing not allowed in current measurement function; CALC:SMO:STAT OFF set"
- 221,"Settings conflict; statistics not allowed in current measurement function; CALC:AVER:STAT OFF set"
- 221,"Settings conflict; TRIG:LEVel value < minimum for current measurement function/range; TRIG:LEV MIN selected"
- 221,"Settings conflict; TRIG:LEVel value > maximum for current measurement function/range; TRIG:LEV MAX selected"
- 221,"Settings conflict; trigger count must be 1 in pretrigger mode; TRIG:COUN 1 set"
- 221,"Settings conflict; trigger source is BUS"
- 222,"Data out of range"
- 222,"Data out of range; value clipped to lower limit"
- 222,"Data out of range; value clipped to upper limit"
- 222,"Data out of range; value requires license DIG"
- 222,"Data out of range; value requires license MEM"
- 223,"Too much data"
- 224,"Illegal parameter value"
- 225,"Out of memory; measurement data overrun"
- 230,"Data corrupt or stale"
- 231,"Data questionable; requested sample timing not met"
- 240,"Hardware error; cannot communicate with measurement hardware"
- 240,"Hardware error; CPU board initialization failed"
- 240,"Hardware error; GPIB interface failed"
- 240,"Hardware error; measurement FPGA FIFO overflow"
- 240,"Hardware error; measurement hardware initialization failed"
- 241,"Hardware missing"
- 250,"Mass storage error: file read/write error"

SCPI Programming Reference

- 250,"Mass storage error; internal file system could not be opened"
- 250,"Mass storage error; USB file system could not be opened"
- 253,"Corrupt media; file system corruption detected; reformat needed"
- 253,"Corrupt media; internal file system format failed"
- 253,"Corrupt media; internal file system scan failed"
- 253,"Corrupt media; USB file system scan failed"
- 256,"File name not found"
- 256,"File or folder name not found"
- 257,"File name error"
- 257,"File name error; access denied"
- 257,"File name error; drive name missing or not recognized"
- 257,"File name error; file or folder already exists"
- 257,"File name error; file too large"
- 257,"File name error; folder is default folder"
- 257,"File name error; folder not empty"
- 257,"File name error; invalid character in name"
- 257,"File name error; not a folder name"
- 257,"File name error; path is a folder name"
- 257,"File name error; path name missing"
- 257,"File name error; path too long"
- 257,"File name error; relative path not allowed"
- 257,"File name error; unknown file extension"
- 292,"Referenced name does not exist"

Device-Specific Errors (-300...)

- 310,"System error"
- 310,"System error: secondary processor aborted due to error"
- 310,"System error; internal software error"
- 310,"System error; out of memory"
- 310,"System error; software initialization failed"
- 313,"Calibration memory lost"
- 313,"Calibration memory lost; due to firmware revision change"
- 314,"Save/recall memory lost; due to firmware revision change"
- 314,"Save/recall memory lost; memory corruption detected"
- 315,"Configuration memory lost"
- 315,"Configuration memory lost; due to firmware revision change"
- 315,"Configuration memory lost; memory corruption detected"
- 350,"Queue overflow"

Query Errors (-400...)

- 400,"Query error"
- 410,"Query INTERRUPTED"
- 420,"Query UNTERMINATED"
- 430,"Query DEADLOCKED"
- 440,"Query UNTERMINATED after indefinite response"

Network Errors (+100...)

- +100,"Network Error"
- +110,"LXI mDNS Error"

SCPI Programming Reference

Instrument Errors (+200...)

- +251, "Unsupported temperature transducer type"
- +263, "Not able to execute while instrument is measuring"
- +292, "State file size error"
- +293, "State file corrupt"
- +294, "Preference file size error"
- +295, "Preference file corrupt"

Miscellaneous Errors (+300... and +500..)

- +311, "Not able to specify resolution with Auto range"
- +320, "Secondary processor communications error: boot message queue overflowed"
- +320, "Secondary processor communications error: command returned error status"
- +320, "Secondary processor communications error: communications restart failed"
- +320, "Secondary processor communications error: communications restart succeeded"
- +320, "Secondary processor communications error: data packet error detected"
- +320, "Secondary processor communications error: read error detected"
- +320, "Secondary processor communications error: write error detected"
- +514, "Not allowed; Instrument locked by another I/O session"
- +532, "Not able to achieve requested resolution"
- +540, "Cannot use overload as math reference"
- +541, "Cannot use zero as math reference for PCT scaling function"
- +542, "Measured dB reference too small"

Licensing and Self-test Errors (+600...)

- +600, "Internal licensing error"
- +601, "License file corrupt or empty"
- +602, "No valid licenses found for this instrument"
- +603, "Some licenses could not be installed"
- +604, "License not found"
- +605, "License already installed"
- +611, "Self-test failed; Real Time Clock reset, check battery"
- +612, "Self-test failed; keyboard processor not responding"
- +613, "Self-test failed; unable to communicate with power controller"
- +614, "Self-test failed; unable to sense line frequency"
- +615, "Self-test failed; measurement processor not responding"
- +616, "Self-test failed; calibration memory reading error"
- +617, "Self-test failed; FPGA unconfigured"
- +618, "Self-test failed; FPGA bus error"
- +619, "Self-test failed; FPGA clock"
- +620, "Self-test failed; shift register"
- +621, "Self-test failed; overload sense stuck on"
- +622, "Self-test failed; ADC generic error"
- +623, "Self-test failed; ADC integrator saturated"
- +624, "Self-test failed; Coarse ADC error"
- +625, "Self-test failed; ADC offset"
- +626, "Self-test failed; ADC noise"
- +627, "Self-test failed; Fine ADC generic error"
- +628, "Self-test failed; Fine ADC off-scale low"
- +629, "Self-test failed; Fine ADC off-scale high"
- +630, "Self-test failed; Fine ADC range"
- +631, "Self-test failed; Fine ADC bits stuck"
- +632, "Self-test failed; Fine ADC slope"
- +633, "Self-test failed; Fine ADC linearity"
- +634, "Self-test failed; low DC zero"

SCPI Programming Reference

+635,"Self-test failed; high DC zero"
+636,"Self-test failed; +7V reference"
+637,"Self-test failed; -10V reference"
+638,"Self-test failed; x1 gain, zero input"
+639,"Self-test failed; x10 gain, zero input"
+640,"Self-test failed; x100 gain, zero input"
+641,"Self-test failed; precharge"
+642,"Self-test failed; x1 gain, non-zero input"
+643,"Self-test failed; x10 gain, non-zero input"
+644,"Self-test failed; x100 gain, non-zero input"
+645,"Self-test failed; 100uA current source"
+646,"Self-test failed; 10uA current source"
+647,"Self-test failed; 2 ohm shunt"
+648,"Self-test failed; AC offset"
+649,"Self-test failed; frequency input"
+650,"Self-test failed; input switch"
+651,"Self-test failed; autocal 10 V range full scale"
+652,"Self-test failed; autocal 10 V range tenth scale"
+653,"Self-test failed; autocal 1 V range full scale"
+654,"Self-test failed; autocal 1 V range tenth scale"
+655,"Self-test failed; autocal 100 mV range full scale"
+656,"Self-test failed; autocal 100 V range reference"
+657,"Self-test failed; autocal 10 kOhm range full scale"
+658,"Self-test failed; autocal 10 kOhm range tenth scale"
+659,"Self-test failed; autocal 1 kOhm range full scale"
+660,"Self-test failed; autocal 100 kOhm tenth scale"
+661,"Self-test failed; autocal 1 MOhm half scale"
+662,"Self-test failed; autocal 100 KOhm to 1 MOhm transfer"
+663,"Self-test failed; autocal 1 MOhm to 10 MOhm transfer"
+664,"Self-test failed; autocal 10 MOhm internal resistor"
+665,"Self-test aborted; high ac voltage present on input terminals"

+666,"Self-test aborted; high dc voltage present on input terminals"

Calibration Errors (+700...)

+701,"Calibration error; security defeated"

+702,"Calibration error; calibration memory is secured"

+703,"Calibration error; secure code provided was invalid"

+704,"Calibration error: secure code too long"

+705,"Calibration error; calibration aborted"

+706,"Calibration error: provided value out of range"

+707,"Calibration error: computed correction factor out of range"

+708,"Calibration error: signal measurement out of range"

+708,"Calibration error; signal frequency out of range"

+709,"Calibration error: no calibration for this function/range"

+710,"Calibration error: full scale correction out of range"

+711,"Calibration error: calibration string too long"

+712,"Calibration failed"

+713,"Calibration error; ADC calibration failed; ADC configuration 'ACI' did not converge"

+713,"Calibration error; ADC calibration failed; ADC configuration 'ACV' did not converge"

+713,"Calibration error; ADC calibration failed; ADC configuration 'DCV' did not converge"

+713,"Calibration error; ADC calibration failed; DC offset for setup 'ACI'"

+713,"Calibration error; ADC calibration failed; DC offset for setup 'ACV'"

+713,"Calibration error; ADC calibration failed; DC offset for setup 'DCV'"

+713,"Calibration error; ADC calibration failed; feedbackLutGainTune unsupported LUT goal"

+713,"Calibration error; ADC calibration failed; feedbackLutTune search did not converge"

+713,"Calibration error; ADC calibration failed; feedbackPiCancel did not converge for setup 'ACI'"

+713,"Calibration error; ADC calibration failed; feedbackPiCancel did not converge for setup 'ACV'"

+713,"Calibration error; ADC calibration failed; feedbackPiCancel did not converge for setup 'DCV'"

+713,"Calibration error; ADC calibration failed; fine merge for setup 'ACI'"

+713,"Calibration error; ADC calibration failed; fine merge for setup 'ACV'"

+713,"Calibration error; ADC calibration failed; fine merge for setup 'DCV'"

+713,"Calibration error; ADC calibration failed; fine offset for setup 'ACI'"

+713,"Calibration error; ADC calibration failed; fine offset for setup 'ACV'"

+713,"Calibration error; ADC calibration failed; fine offset for setup 'DCV'"

+713,"Calibration error; ADC calibration failed; fineDcCancel found non-monotonic value in setup 'ACI'"

+713,"Calibration error; ADC calibration failed; fineDcCancel found non-monotonic value in setup 'ACV'"

+713,"Calibration error; ADC calibration failed; fineDcCancel found non-monotonic value in setup 'DCV'"

+713,"Calibration error; ADC calibration failed; LUT gain for setup 'ACI'"

+713,"Calibration error; ADC calibration failed; LUT gain for setup 'ACV'"

+713,"Calibration error; ADC calibration failed; LUT gain for setup 'DCV'"

+713,"Calibration error; ADC calibration failed; LUT goal incompatible with ACV"

+713,"Calibration error; ADC calibration failed; PI offset for setup 'ACI'"

+713,"Calibration error; ADC calibration failed; PI offset for setup 'ACV'"

+713,"Calibration error; ADC calibration failed; PI offset for setup 'DCV'"

+713,"Calibration error; DCV 10M input impedance gain adjustment out of range"

+715,"Calibration error; must perform +100mV DCV calibration before -100mV"

+715,"Calibration error; must perform +100uA DCI calibration before -100uA"

+715,"Calibration error; must perform +10V DCV calibration before -10V"

+715,"Calibration error; must perform 10MOhm calibration before 100MOhm"

+720,"Calibration error; DCV offset out of range"

+721,"Calibration error; DCI offset out of range"

+722,"Calibration error; RES offset out of range"

+723,"Calibration error; FRES offset out of range"

+724,"Calibration error; extended resistance self cal failed"

+725,"Calibration error; 1000V DC correction out of range"

+726,"Calibration error; ACV offset out of range"

+727,"Calibration error; ACI offset out of range"

+730,"Calibration error; precharge DAC convergence failed"

+731,"Calibration error; A/D turnover correction out of range"

+732,"Calibration error; AC flatness calibration failed"

+733,"Calibration error; AC low frequency correction out of range"

+734,"Calibration error; AC flatness calibration restarted by function/range change"

+735,"Calibration error; 1 kHz AC flatness frequency point must be last frequency point in sequence"

+736,"Calibration error; DCI 100uA range self-cal failed"

+740,"Calibration data lost: secure state"
+740,"Calibration information lost; count, security state, security code, string"
+741,"Calibration data lost: string data"
+742,"Calibration data lost: corrections"
+746,"System information write failure"
+747,"System information read failure"
+748,"Calibration memory write failure"
+749,"Calibration memory read failure"
+750,"Autocalibration corrections lost lost; due to firmware revision change"
+750,"Autocalibration corrections lost"
+751,"Autocalibration memory write failure"
+752,"Autocalibration memory read failure"
+753,"Autocalibration measurement out of range"
+760,"Operation aborted; high voltage present on input terminals"

Miscellaneous Errors (+800...)

+800,"Nonvolatile memory write failure"
+810,"State has not been stored"
+820,"Model and serial numbers not restored"
+821,"Controller and measurement board model numbers do not match"
+822,"Controller and measurement board serial numbers do not match"
+823,"Incorrect firmware loaded for this model number"

Power-On and Reset State

These tables show factory default settings. Parameters marked with a bullet (·) are nonvolatile and are not affected by power-on or system reset. Other parameters are volatile and are reset to the indicated values at power-on or after ***RST** or **SYSTem:PRESet**.

NOTE

The power-on/reset state may differ from these values if you have enabled power-on state recall mode.

Factory Default Settings

Measurement Configuration	Factory Setting
Function	DC Volts
Range	Autorange (for all functions)
Integration Time	NPLC On, 10 power line cycles (PLC)*
Resolution	Resolution equivalent to 10 PLC
Autozero	On*
Aperture (34465A/70A only)*	Off, 100 ms
Frequency or Period Aperture (Gate Time)	100 ms*
· Input Impedance	· 10 MΩ (fixed for all DC voltage ranges)
AC Input Filter (bandwidth)	20 Hz (medium filter)
Temperature Transducer Type	FRTD
RTD Reference Resistance	100 Ω
Nulls (individual functions)	Off; reference = 0.0, auto reference enabled (for all measurement functions)
Current Terminals	3 A
Secondary Measurements	Off
Screen Shot Format	PNG
Calibration Value	0.0
Current Switch Mode (34465A/70A only)	Continuous
Resistance (2- and 4-wire) (34465A/70A only):	
Offset Compensation	Off
Low Power Measurements	Off
Temperature (34465A/70A only):	
Offset Compensation (2- and 4- wire RTD)	Off
Low Power Measurements(2- and 4- wire RTD or thermistor)	Off
Thermocouple (34465A/70A only):	
Check	Off
Reference Junction Temperature, Type, Adjust	0° C, Internal, 0° C
Thermocouple Type	J
* For all DC measurement functions.	

Math Operations	Factory Setting
Math State	Disabled
Scale Function	Null
Null and dB Relative Value	Set to 0.0 with auto reference enabled
Upper and Lower Limits	0.0
Histogram	Bin counts cleared; 100 bins; auto binning enabled
Statistics	Cleared
• dBm Reference Resistance	• 600 Ω
Calculate Scale (34465A/70A only):	
Gain	1.0
Offset	0.0
Reference	0.0
Unit State	Off
Unit	Null String
Calculate Smoothing (34465A/70A only):	
Response	Fast
State	Off

Triggering Operations	Factory Setting
Trigger Count	1
Trigger Source	Immediate
Trigger Delay	Auto Delay
Sample Count	1
Trigger Slope	Negative
VM Comp Output Slope	NEG
Pretrigger Count (34465A/70A only)	0
Triggering (34465A/70A only):	
Sample Source	Immediate
Sample Timer	1 s
Trigger Level	0.0

System-Related Operations	Factory Setting
• Beeper Mode	• On
• Thousands Separator	• On
Display State	On
Reading Memory	Cleared
Error Queue	See note
• Stored States	• No Change
• Calibration State	• Secured

SCPI Programming Reference

Data Settings	Factory Setting
Binary Block Data Format (34465A/70A only):	
Border	Normal
Data	ASCII, 9
Data Transfer (34465A/70A only):	
Separator	Comma
Header	Off
Reading Limits	Off

NOTE

The Error Queue is cleared at power on. It is not cleared by ***RST**, **SYSTem:PRESet**, or a front panel Preset.

Input/Output Configuration	Factory Setting
Enable Interfaces: ¹	
• LAN	• Enabled
• GPIB	• Enabled
• USB	• Enabled
LAN Settings: ²	
• DHCP	• On
• Auto IP	• On
• IP Address	• 169.254.4.61
• Subnet Mask	• 255.255.0.0
• Default Gateway	• 0.0.0.0
• DNS Server	• 0.0.0.0
• Host Name	• K-34460A- <i>nnnnn</i> (for 34460A) ³ • K-34461A- <i>nnnnn</i> (for 34461A) • K-34465A- <i>nnnnn</i> (for 34465A) • K-34470A- <i>nnnnn</i> (for 34470A)
• LAN Services ¹	• Enable All (<i>VISA LAN, Sockets, Telnet, Web Server, mDNS, HiSLIP</i>)
GPIB Settings:	
• GPIB Address	• 22
<p>¹ Interface enable or LAN service changes take effect only after you cycle power. ² LAN setting changes require a LAN restart. From SCPI you must cycle power. ³ Where <i>nnnnn</i> represents the last 5 digits of the instrument serial number.</p>	

NOTE

The instrument uses LAN port 5024 for SCPI Telnet sessions and port 5025 for SCPI Socket sessions.

Service and Repair

This section contains basic instrument service information.

Types of Service Available

Cleaning

Electrostatic Discharge (ESD) Precautions

Additional service information is found here:

Power Supplies

Troubleshooting

Self-Test Procedures

User Replaceable Parts

Disassembly

Battery Replacement

3 A and 10 A Current Path Fuse Replacement

Installing the Optional GPIB Interface

Types of Service Available

If your instrument fails during the warranty period, Keysight Technologies will repair or replace it under the terms of your warranty. After your warranty expires, Keysight offers repair services at competitive prices. You also have the option to purchase a service contract that extends coverage after the standard warranty expires.

Obtaining Repair Service (Worldwide)

To obtain service for your instrument, [contact your nearest Keysight Technologies Service Center](#). They will arrange to have your unit repaired or replaced, and can provide warranty or repair-cost information where applicable. Ask the Keysight Technologies Service Center for shipping instructions, including what components to ship. Keysight recommends that you retain the original shipping carton for return shipments.

Repackaging for Shipment

To ship the unit to Keysight for service or repair:

- Attach a tag to the unit identifying the owner and indicating the required service or repair. Include the model number and full serial number.
- Place the unit in its original container with appropriate packaging material.
- Secure the container with strong tape or metal bands.
- If the original shipping container is unavailable, use a container that will ensure at least 10 cm (4 in.) of compressible packaging material around the entire instrument. Use static-free packaging materials.
- Remove the GPIB interface module from the instrument if the instrument is equipped with the GPIB interface module and the module is not having a failure.

Keysight suggests that you always insure shipments.

Cleaning

To prevent electrical shock, disconnect the instrument from AC mains power and disconnect all test leads before cleaning. Clean the outside of the instrument using a soft, lint-free, cloth slightly dampened with water.

Do not use detergent or solvents.

Do not attempt to clean internally.

If needed, contact a Keysight Technologies Sales and Service office to arrange for proper cleaning to ensure that safety features and performance are maintained.

Electrostatic Discharge (ESD) Precautions

Almost all electrical components can be damaged by electrostatic discharge (ESD) during handling. Component damage can occur at electrostatic discharge voltages as low as 50 V.



The following guidelines will help prevent ESD damage during service operations:

- Disassemble instruments only in a static-free work area.
- Use a conductive work area to reduce static charges.
- Use a conductive wrist strap to reduce static charge accumulation.
- Minimize handling.
- Keep replacement parts in original static-free packaging.
- Remove all plastic, foam, vinyl, paper, and other static-generating materials from the immediate work area.

Component side of board

For the following measurements, the instrument should be turned on, and the light below the power switch should be green.

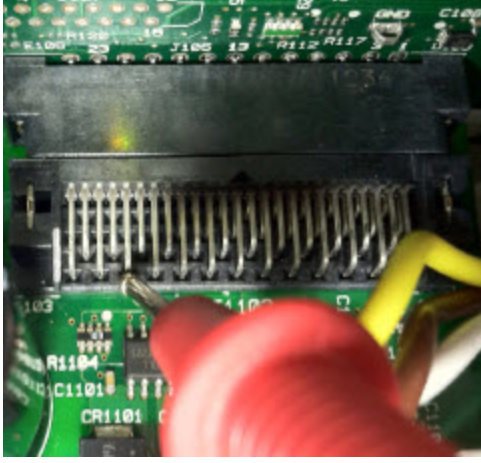
Refer to the detailed images in the table below for exact location information.

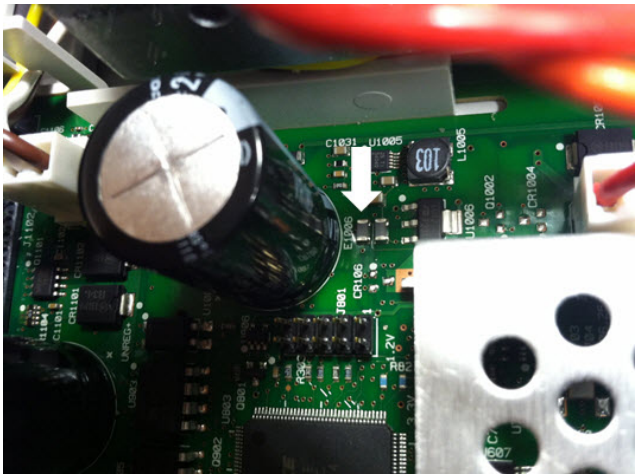
Pin	Location Detail
<p>Low reference: chassis J1102 pin 21: 3.3 V \pm 5%</p>	
<p>Low reference: large metal shield R1020 (either side of component): 10 V \pm 20%</p>	
<p>Low reference: large metal shield E1006 (either side of component): 3.3 V \pm 5%</p>	

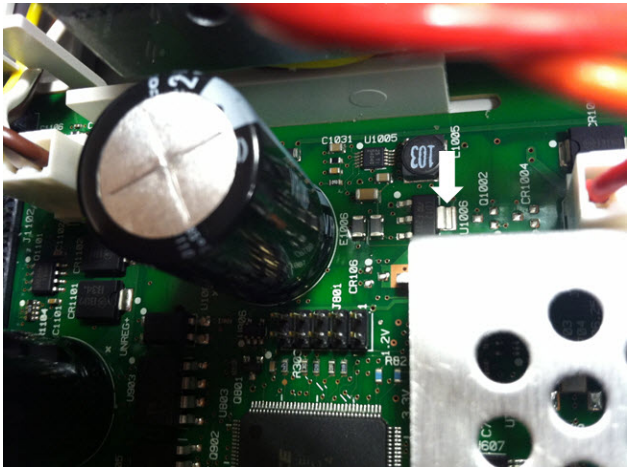
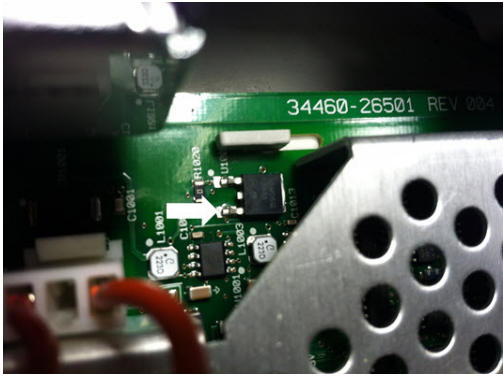
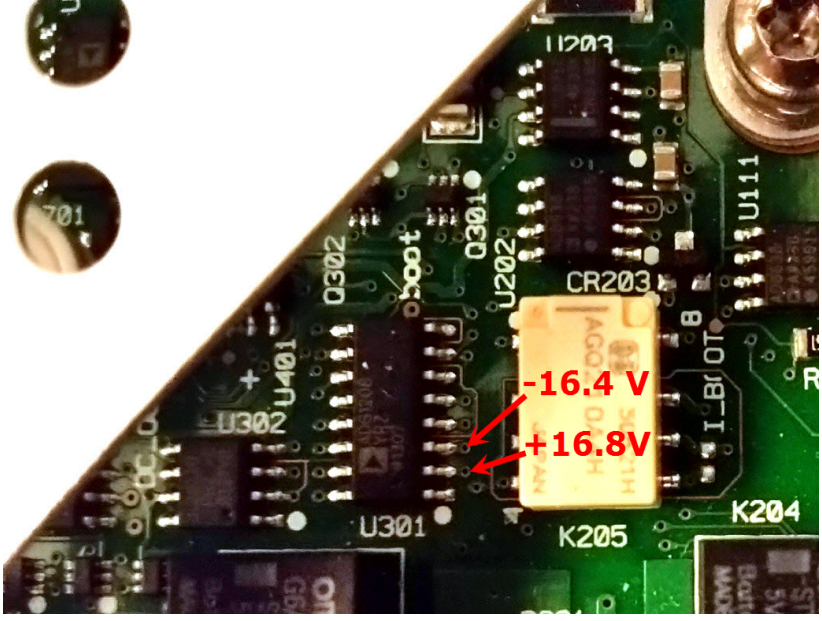
Pin	Location Detail
<p>Low reference: large metal shield</p> <p>U1006 (large tab on right side as shown in picture):</p> <p>1.2 V \pm 5%</p>	
<p>Low reference: large metal shield</p> <p>U1004 pin 3:</p> <p>5 V \pm 5%</p>	
<p>Low reference: large metal shield</p> <p>U301:</p> <p>pin 2: +16.8 V \pm 5%</p> <p>pin 3: -16.4 V \pm 5%</p>	

Troubleshooting

Before troubleshooting or repairing the instrument, make sure the failure is in the instrument rather than any external connections. Also make sure that the instrument was accurately calibrated within the last year (see [Calibration Interval](#)). The instrument's circuits allow troubleshooting and repair with basic test equipment.

CAUTION

DO NOT swap the motherboard or the front panel board from one instrument to another. These boards contain model number and serial number information that uniquely identifies a specific unit, and boards that are mismatched to the instrument may result in problems with its performance, licensing, serviceability, importability/exportability or warranty.

Troubleshooting Procedure

1. Remove all remote I/O connections and front panel connections to the instrument. Verify that:
 - a. the AC mains power cord is securely connected to the instrument and plugged into a live outlet
 - b. the front panel Power On/Standby switch has been pushed
2. If the standby light below the power switch is not illuminated, re-verify the items above. If all this is correct, check the AC mains power and then the internal line fuse.
3. If the standby light is on (yellow or green), press the power button. If there is no response, replace the front panel board because the power button on the front panel board is likely broken.
4. **Check the voltages on the power supply.** If one or more of these tests fail, disconnect the transformer secondaries from the main board and measure the voltages from the transformer with an AC voltmeter.

The voltage between the red and orange wires (below) should measure 7.5 to 11 VAC.

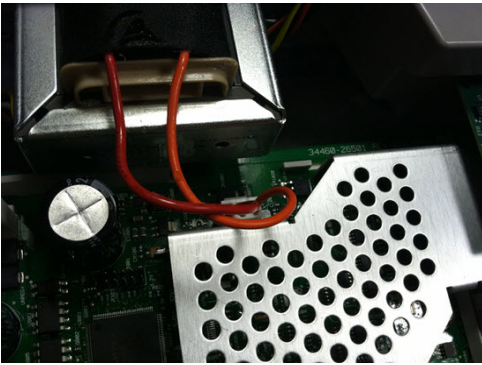

The voltage between the brown and white wires (below) should measure 11 to 15 VAC.

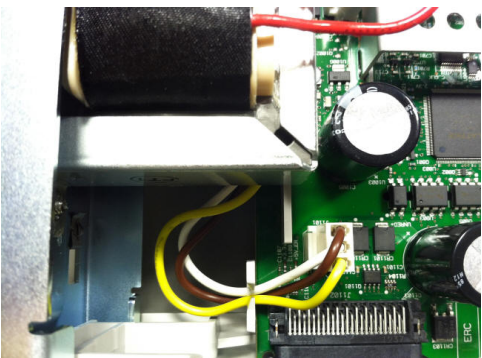

5. If the voltages are correct, replace the main board; otherwise replace the transformer.

Service and Repair

6. Turn the instrument on. If the power-on sequence completes and the display appears to function properly, verify that the instrument is in local mode (the Remote annunciator in the upper right corner of the display is not on), and run the full self-test ([Utility] > Test/Admin > Self-Test > Full Test). If the display is illegible, replace the front panel board.

CAUTION

Ensure that all connections (front and rear) are removed when self-test is performed. During self-test, errors may be induced by signals present on external wiring, such as long test leads that can act as antennas.

7. If the self test generates an error, record the error code and message and contact Keysight support if necessary.
8. If the self test does not generate an error:
 - a. If remote I/O on GPIB (optional) is not working, replace the GPIB board.
 - b. If the measurements are out of specification, you may wish to calibrate the instrument before deciding to replace the main board.
 - c. If the front panel buttons are not working, make sure the unit is in local mode (the Remote annunciator in the upper right corner of the display is not displayed). If that does not solve the problem, replace the front panel board.
 - d. If the display is dim, **adjust the display intensity**.
9. If the instrument does not complete the power-on sequence, check the signal frequency at test point TP200 on the front panel board and verify that it is 29.8 kHz \pm 500 Hz. If the frequency is not correct, replace the front panel board.

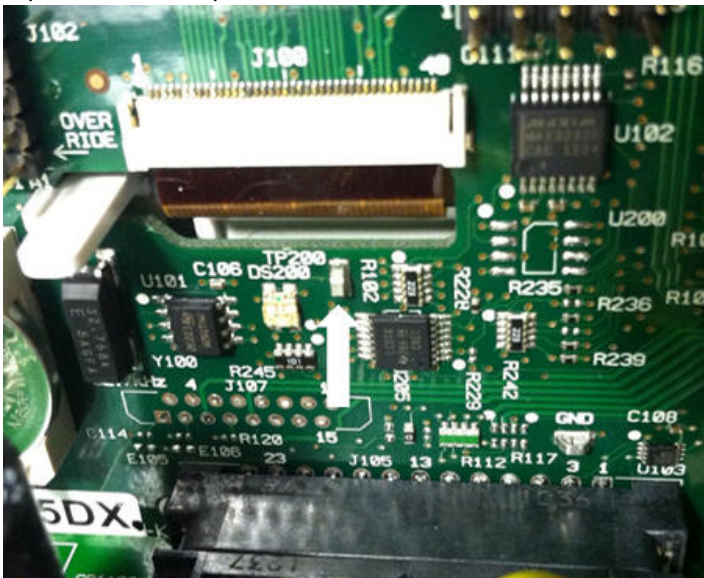

10. Also verify that the voltage is $3.3\text{ V} \pm 5\%$ at resistor R121, referenced to the instrument chassis. If this voltage is incorrect, replace the front panel board.

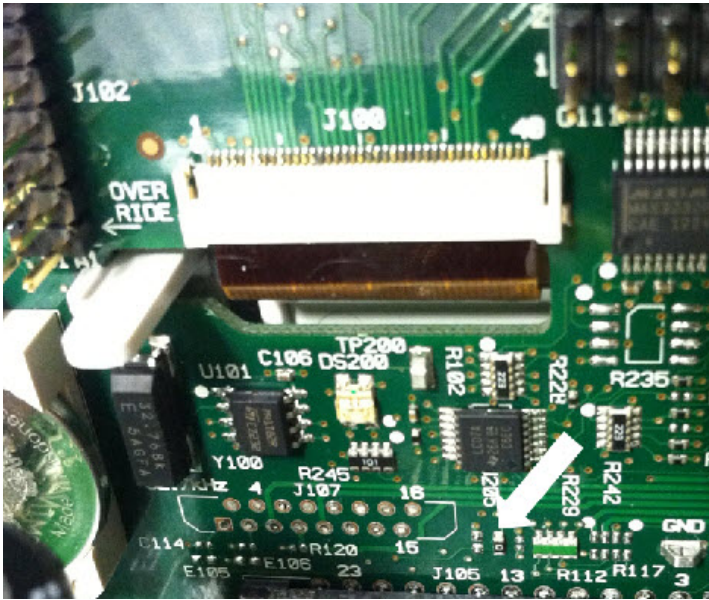

Self-Test Procedures

Power-On Self-Test

Each time the instrument is powered on, it performs a self-test on its real-time clock, keyboard processor, power controller, measurement processor, calibration memory, FPGA, ADC, gain and offset circuitry, and voltage references. This self-test is equivalent to the *TST? SCPI query, and you do not need to remove inputs to the instrument to run the test.

Full Self-Test

A complete self-test (**TEST:ALL?**) takes approximately two seconds. This tests all of the items tested by the power-on self-test and includes further tests for gain, current source, and shunt circuitry.

When self-test completes, either "Self-test Passed" or "Self-test Failed" appears on front panel.

Execute the complete self-test before performing any verification or calibration procedures.

CAUTION You must remove all input connections to the instrument before running the full self-test.

Remote I/O Execution

1. Connect to the instrument using the remote interface (**Remote Interface Configuration**).
2. Send ***TST?** or **TEST:ALL?** and read the result: pass (+0) or fail (+1). Use **SYSTEM:ERRor?** to view errors. See the **list of self-test errors** for details.

Front Panel Execution

1. Press **[Shift] > [Utility] > Test/Admin > Self Test**.
2. View any failures by pressing **[Shift] > [Help] > View remote command error queue**.

User Replaceable Parts

Replacement parts for the instrument are listed below. Unless otherwise shown, all parts apply to all Truevolt models.

Part Number	Description
34401-86020	Bumper Kit
33220-88304	Rear Bezel
34401-45021	Handle
33220-84101	Cover
5041-5228	Keypad
2090-1051	Display
2110-0817	Line Fuse (250 mA, 250 V, time delay)
2110-1547	Current Protection Fuse (3.15 A, 500 VAC/ 400 VDC, time delay)
2110-1402	Internal Fuse (11 A, 1000 V, fast acting)
34460-87910	Transformer
34401-45012	Terminal Latch
5041-5238	Power Module
34460-40201	Plastic Front Panel (34460A)
34461-40201	Plastic Front Panel (34461A)
34465-40201	Plastic Front Panel (34465A)
34470-40201	Plastic Front Panel (34470A)
53200-49311	Window
5041-5231	Front Panel Shield
5041-5225	Front/Rear Push Rod (34461A, 34465A, 34470A)
5041-5232	Fan (34461A, 34465A, 34470A)
5041-5261	Fan Shield (34465A, 34470A)
5041-5257	Cable Assembly, Thermistor (34465A, 34470A)
1420-0356	Battery (in front panel)
34470-66303	Reference Assembly

Disassembly

This section describes the procedure for disassembling the instrument.

WARNING

Only qualified, service-trained personnel who are aware of the hazards involved should remove instrument covers. Always disconnect the power cable and any external circuits before removing the instrument cover. Some circuits are active and have power applied even when the power switch is turned off.

Always disconnect all inputs, cords, and cables before disassembling the instrument.

CAUTION

Do not turn the screw that fastens the shield in place, as this will affect the instrument's calibration.



Tools Required

The following tools are required.

- T20 Torx driver (most disassembly)
- Small, flat-blade screw driver (for prying)

General Disassembly Procedure

1. Turn off the power and remove all measurement leads and other cables, including the power cord, from the instrument before continuing.
2. Rotate the handle to the upright position and remove it by pulling outward where it attaches to the case.



3. Pull off the front rubber bumper.
4. Unscrew the two captive screws in the rear bezel and remove the rear bezel and rubber bumper.



5. Remove the screw on the bottom of the instrument and place it in a safe location for re-assembly. Slide off the instrument cover.



NOTE

At this point, the instrument is sufficiently disassembled for power supply troubleshooting purposes. You could also change the battery or **override calibration security** at this point. If you need to disassemble the front panel, continue with the steps shown below.

Service and Repair

6. Use the small, flat-blade screwdriver to pry the black latch up and remove it. Note the orientation of the latch for re-assembly purposes.



7. Push in on the lever shown, and squeeze the metal frame of the instrument to release the front panel plastic.

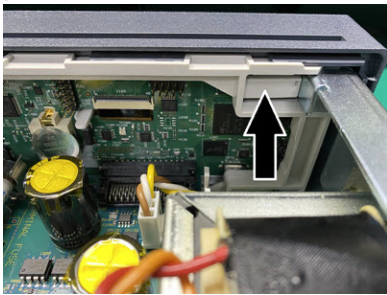

8. Slide the front panel off.
9. Slide the white plastic backing plate to the right and lift up on the left side of the backing plate to remove it.



10. Remove the front panel PCBA by holding the connector housing shown below and lifting it out.

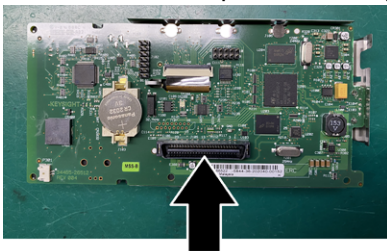

11. Remove the ESD shield by prying it out gently from the plastic housing to which it attaches.

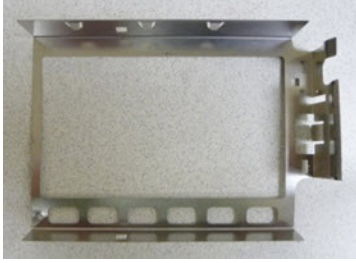

This concludes the disassembly procedure. To re-assemble the instrument, reverse the procedure.

Battery Replacement

This section describes the procedure for replacing the battery on the instrument's front panel.

WARNING

Only qualified, service-trained personnel who are aware of the hazards involved should remove instrument covers. Always disconnect the power cable and any external circuits before removing the instrument cover. Some circuits are active and have power applied even when the power switch is turned off.

Always disconnect all inputs, cords, and cables before disassembling the instrument.

Tools Required

- T20 Torx driver (most disassembly)
- Small, flat-blade screw driver (for prying)

Procedure

(Images shown below provided courtesy of Keystone Electronics Corp.)

1. Turn off the power and remove all measurement leads and other cables, including the power cord, from the instrument before continuing.
2. Follow the [disassembly procedure](#) to disassemble the instrument.
3. Locate the battery on the front panel, and position the screwdriver tip under the battery, as shown.



4. Use the screwdriver to pry the battery from the battery holder.



5. Remove the battery and discard or recycle it in accordance with all applicable regulations.
6. Position the new battery in the battery holder, + side up. Push down gently to seat the battery in the holder.

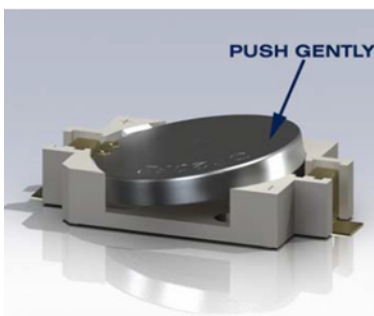

7. Re-assemble the instrument completely before connecting any cables or cords.

This concludes the battery replacement procedure.

3 A and 10 A Current Path Fuse Replacement

This section describes the procedure for testing and replacing the 3 A and 10 A current path fuses inside the instrument.

WARNING

Only qualified, service-trained personnel who are aware of the hazards involved should remove instrument covers. Always disconnect the power cable and any external circuits before removing the instrument cover. Some circuits are active and have power applied even when the power switch is turned off.

Always disconnect all inputs, cords, and cables before disassembling the instrument.

CAUTION

Do not turn the screw that fastens the shield in place, as this will affect the instrument's calibration.



Tools Required

- T20 Torx driver (most disassembly)
- Small, flat-blade screw driver (for prying)

Testing the Fuses

3 A Current Path

To determine whether the instrument's 3 A current path has a fuse that must be replaced, press **[Cont]** to put the DMM in continuity measurement mode, and short the HI Input terminal to the 3 A current terminal. If the measurement displays OPEN, one of the two fuses must be replaced. One fuse is accessible from the instrument's rear panel; the other is internal.

If the 3 A current path has a bad fuse, it is very likely to be the fuse accessible from the lower left corner of the instrument's rear panel (part number 2110-1547, 3.15 A, 500 VAC/400 VDC, time delay). Simply use a flat-blade screw driver to turn the fuse holder counter-clockwise and access the fuse. Put the new fuse into the fuse holder and insert the assembly back into the instrument, turning the fuse holder clockwise to lock it in place.

If the 3 A path still has a bad fuse, replace the internal 3 A current path fuse as described below.

10 A Current Path (34461A/65A/70A only)

To determine whether the instrument's 10 A current path has a fuse that must be replaced, press **[Cont]** to put the DMM in continuity measurement mode, and short the HI Input terminal to the 10 A current terminal. If the measurement displays OPEN, replace the internal 10 A current path fuse as described below.

Internal Fuse Replacement Procedure

Both internal current path fuses are part number 2110-1402, 11 A, 1000 V, fast acting. To replace an internal fuse:

1. Turn off the power and remove all measurement leads and other cables, including the power cord, from the instrument before continuing.
2. Follow the [disassembly procedure](#) to disassemble the instrument.
3. Locate the fuse to be replaced, as shown below.

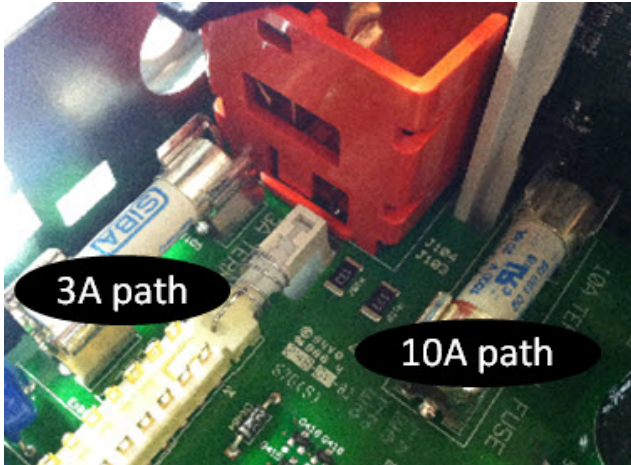

4. Use the screwdriver to pry the fuse from the fuse holder, being careful not to damage the circuit board. For the 3 A fuse, it may be easiest to access the fuse from the side, through the rectangular aperture in the sheet metal.
5. Remove the fuse.
6. Position the new fuse in the fuse holder. Push down gently to seat the fuse in the holder.
7. Re-assemble the instrument completely before connecting any cables or cords.

This concludes the fuse replacement procedure.

Installing the Optional GPIB Interface

WARNING

This procedure should be performed by qualified service personnel only. Turn off the power and remove all measurement leads and other cables, including the power cord, from the instrument before continuing.

Tools Required

The following tools are required.

- T10 Torx driver

Installation Procedure

Turn off the power and remove all measurement leads and other cables, including the power cord, from the instrument before continuing.

Use the Torx driver to remove the screw from the GPIB cover plate. Retain the screw for use later in this procedure. Then remove the cover plate by sliding it to the left.

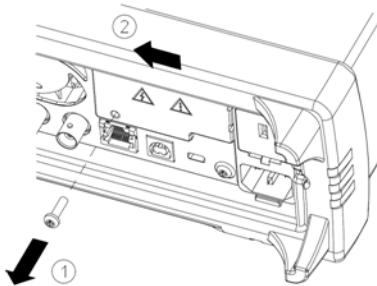

WARNING

Retain GPIB Cover Plate

After installing the GPIB option, retain the cover plate for use in the event that you ever remove the GPIB option. The instrument should never be connected to power or inputs on the measurement terminals without either the GPIB module or the cover plate securely covering the rear-panel opening.

Locate the connector, just inside the unit, for the cable attached to the GPIB module

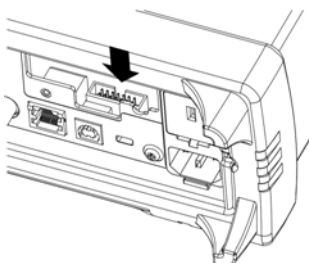

Service and Repair

Bend the cable so that it extends above the circuit board. Attach the cable to the connector that was located in the previous step.

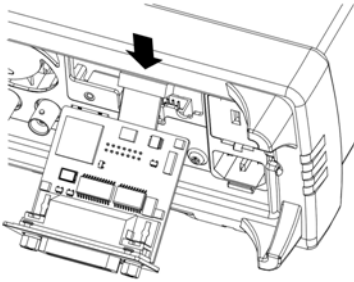

Put the module into the unit and slide the GPIB board to the right so that it is flush against the instrument's sheet metal. Use the screw that was removed above to secure the GPIB plate in place.

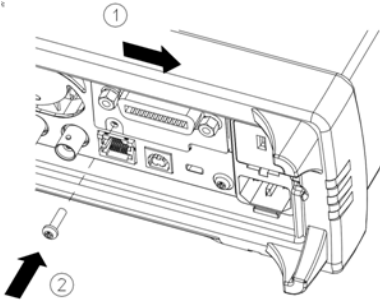

This concludes the GPIB installation procedure.

Security Code Override

The instrument security code (calibration password) is set to AT3446XA at the factory. If it has been changed and you no longer remember the code, you can reset the code back to its factory default value by using one of the two following procedures.

Which Procedure Should I Use?

From the instrument front panel, press **[Shift]** > **[Help]** > **About** to view the instrument firmware revision. An example display is:

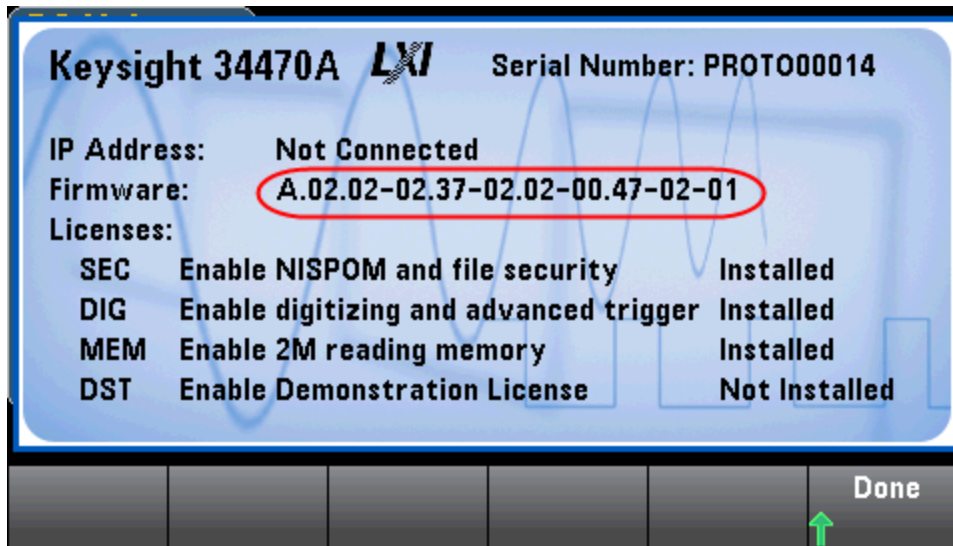

The last two digits of the firmware revision indicate the front panel PC board revision and which of the two procedures you should use. If the firmware revision ends with 02 or greater, use **Procedure A**. If the firmware revision ends with 01, use **Procedure B**.



If you encounter problems, contact Keysight Technologies for technical support.

In the United States: (800) 829-4444

In Europe: 31 20 547 2111

In Japan: 0120-421-345

Use www.keysight.com/find/assist to contact Keysight worldwide, or contact your Keysight Technologies representative.

Procedure A: For Firmware Revision Ending in 02, or Greater

WARNING This procedure should be performed by qualified service personnel only. Turn off the power and remove all measurement leads and other cables, including the power cord, from the instrument before continuing.

1. Follow the [disassembly procedure](#) to disassemble the instrument.
2. Locate connector J102 on the front panel board. Short pin A1 to B1 as shown by the orange line below.

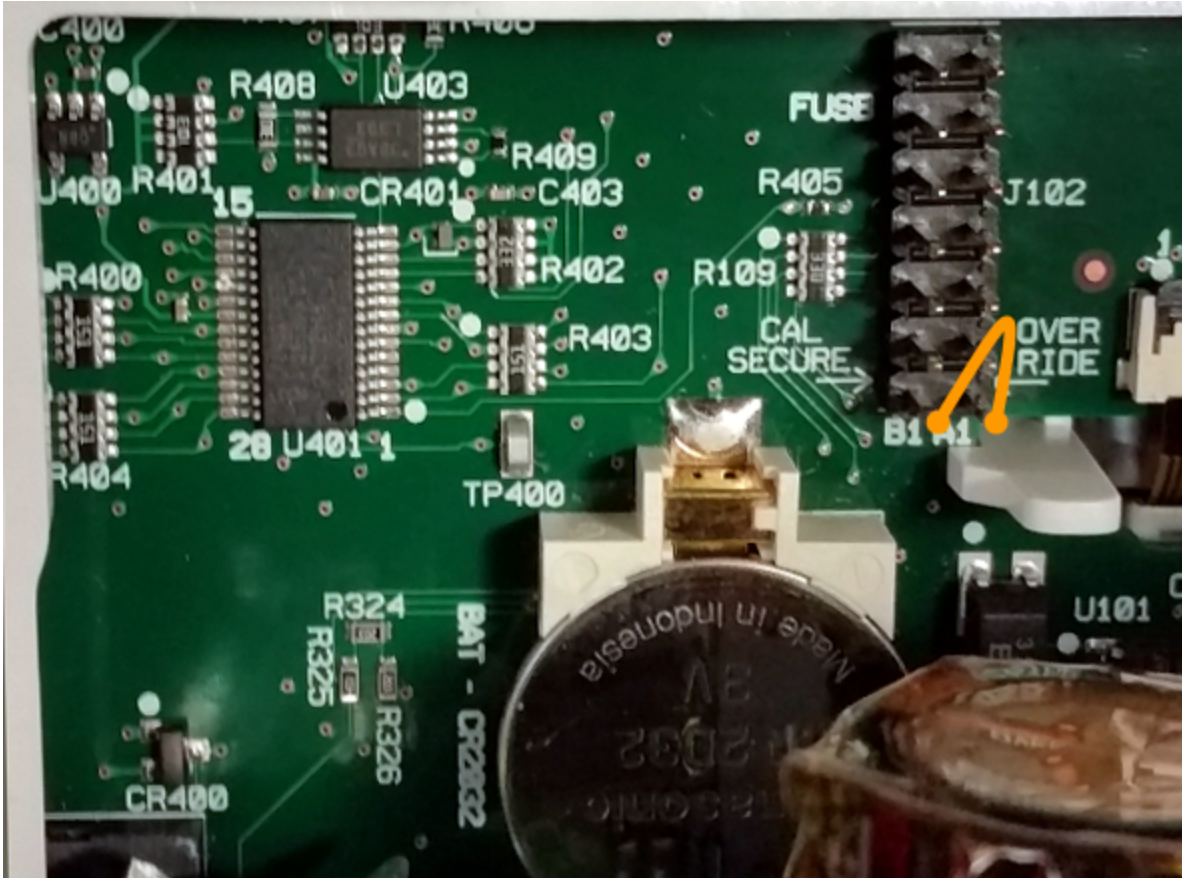

3. Reassemble the instrument, apply power and turn it on; the instrument will generate an error and beep (this is normal). Wait 30 to 40 seconds for the instrument to power up completely.
4. Reset the security code to the factory default:
 - a. Press **[Shift]** > **[Utility]** > **Test / Admin** > **Security** > **New Code**.
 - b. Enter AT3446XA as the new passcode.
 - c. Press **Done**.
 - d. Verify the new code and press **Yes** to confirm the change.

5. Remove power, disassemble the instrument, and remove the short. Then reassemble the instrument to complete the security code (calibration password) reset procedure.

Procedure B: For Firmware Revision Ending in 01

WARNING This procedure should be performed by qualified service personnel only. Turn off the power and remove all measurement leads and other cables, including the power cord, from the instrument before continuing.

1. Follow the [disassembly procedure](#) to disassemble the instrument.
2. Locate connector J102 on the front panel board. Short pin A1 to A6 or A7 as shown by the orange lines below. You do not need to short both pins to A1, just one of them.

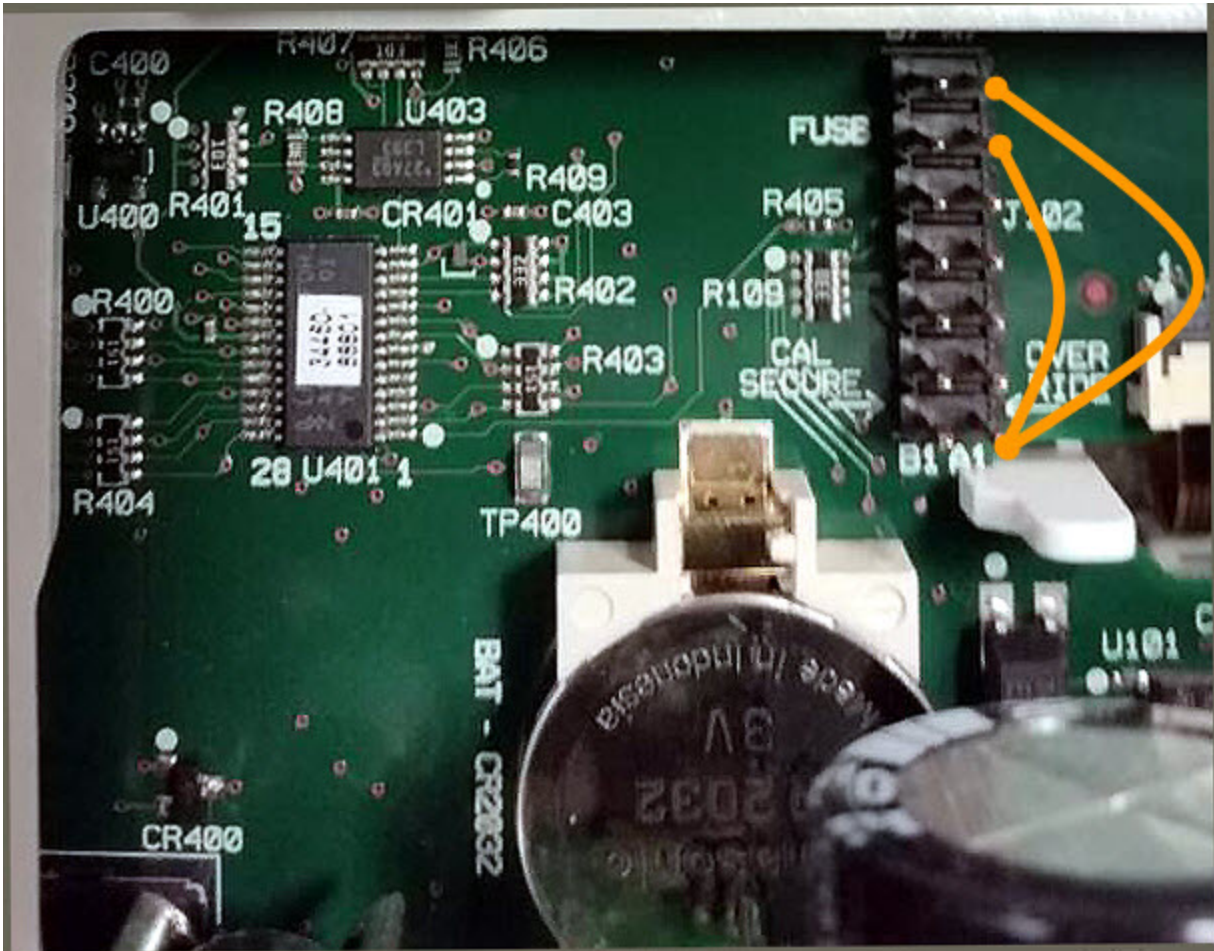

3. Reassemble the instrument, apply power and turn it on; the instrument will generate an error and beep (this is normal). Wait 30 to 40 seconds for the instrument to power up completely.

4. Reset the security code to the factory default:
 - a. Press **[Shift]** > **[Utility]** > **Test / Admin** > **Security** > **New Code**.
 - b. Enter AT3446XA as the new passcode.
 - c. Press **Done**.
 - d. Verify the new code and press **Yes** to confirm the change.
5. Remove power, disassemble the instrument, and remove the short. Then reassemble the instrument to complete the security code (calibration password) reset procedure.

Performance Verification

Use the performance verification tests in this section to verify the measurement performance of the instrument using the instrument's specifications listed in the product data sheet.

You can perform three different levels of performance verification tests:

- **Self-Test (two types):** Internal verification tests that give a high confidence that the instrument is operational, as described [here](#).
- **Quick Verification:** A combination of the internal self-tests and selected verification tests.
- **Performance Verification Tests:** An extensive set of tests that are recommended as an acceptance test when you first receive the instrument or after performing calibration:
 - [Zero Offset Verification](#)
 - [DC Volts and DC Current Gain Verification](#)
 - [Frequency Accuracy Verification](#)
 - [AC Voltage and AC Current Verification](#)
 - [High Current Verification](#)
 - [Capacitance Verification \(Optional Verification Test\)](#)

Quick Performance Check

The quick performance check is a combination of internal self-test and an abbreviated performance test (specified by the letter Q in the performance verification tests). This provides a simple method to achieve high confidence in the instrument's ability to functionally operate and meet specifications. These tests represent the absolute minimum set of performance checks recommended following any service activity. Auditing the instrument's performance for the quick check points (designated by a Q) verifies performance for "normal" accuracy drift mechanisms. This test does not check for abnormal component failures.

To perform the quick performance check, do the following:

- Perform a **self-test**.
- Perform only the performance verification tests indicated with the letter **Q**.

If the instrument fails the quick performance check, calibration or repair is required.

The Quick Performance Check can be limited by the factors described in the following section (*Performance Verification Tests*).

Performance Verification Tests

The performance verification tests are recommended as acceptance tests when you first receive the instrument. The acceptance test results should be compared against the 90 day test limits. You should use the 24 hour test limits only for verification within 24 hours after performing the calibration adjustment procedure.

If a Fluke 5725A Calibrator is not available, current verification can be limited to 2A. This will limit the span of verification on the 10A ranges to only 2A.

If the instrument fails performance verification, calibration adjustment or repair is required.

To reset the date used to determine the specifications versus time, a calibration with adjustment is required.

The allowable errors for verification are the published specifications (see the instrument data sheet at www.keysight.com/find/truevolt-doc). The periods in the published specifications are since the last full calibration adjustment.

Recommended Test Equipment

The recommended test equipment for the performance verification and calibration is listed below. If the exact instrument is not available, substitute calibration standards of equivalent accuracy.

An alternate method is to use the Keysight 3458A 8½-digit Digital Multimeter to measure less accurate, yet stable, sources. The output value measured from the source can be entered into the instrument as the target calibration value.

Application	Recommended Equipment
Zero Calibration	Keysight 34172B
DC Voltage	Fluke 5720A
DC Current	Fluke 5720A
Resistance	Fluke 5720A
AC Voltage	Fluke 5720A
AC Current	Fluke 5720A
Frequency	Keysight 33500B Series Function/Arbitrary Waveform Generator
High Current	Fluke 5725A
Capacitance (Optional)	SCA-1uF Capacitance Standard

Zero Offset Verification

This procedure checks the instrument's zero offset performance. Verification checks are only performed for those functions and ranges with unique offset calibration constants. Measurements are checked for each function and range as described below.

1. Make sure you have read **Test Considerations**.
2. Install the 34172B Calibration Short (or equivalent) on the front panel input terminals. Select the Front input terminals with the Front/Rear switch.
3. Configure each function and range in the order shown in the table below corresponding to the DMM model number. Make a measurement and return the result. Compare measurement results to the test limits shown below.
4. Install the 34172B Calibration Short (or equivalent) on the rear-panel input terminals. Select the Rear input terminals with the Front/Rear switch.
5. Configure each function and range in the order shown in the table below corresponding to the DMM model number. Make a measurement and return the result. Compare measurement results to the test limits shown below.

Values for 34460A DMM							
Input	Function ^[1]	Range	Quick Check	Error from Nominal			
				24 hours	90 days	1 year	2 years
Open	DC Current	100 μ A	Q	$\pm 0.02 \mu$ A	$\pm 0.025 \mu$ A		
		1 mA		$\pm 0.060 \mu$ A			
		10 mA		$\pm 2 \mu$ A			
		100 mA		$\pm 4 \mu$ A	$\pm 5 \mu$ A		
		1 A		$\pm 60 \mu$ A	$\pm 100 \mu$ A		
		3 A		$\pm 600 \mu$ A			
Short	DC Volts	100 mV	Q	$\pm 6 \mu$ V	$\pm 6.5 \mu$ V		
		1 V		$\pm 9 \mu$ V	$\pm 10 \mu$ V		
		10 V		$\pm 40 \mu$ V	$\pm 50 \mu$ V		
		100 V		$\pm 600 \mu$ V			
		1000 V		± 6 mV	± 10 mV		
Short	4-wire Ohms	100 Ω		± 6 m Ω	± 7 m Ω		
		1 k Ω		± 8 m Ω	± 10 m Ω		
		10 k Ω	Q	± 50 m Ω	± 100 m Ω		
		100 k Ω		± 500 m Ω	$\pm 1 \Omega$		
		1 M Ω		$\pm 10 \Omega$			
		10 M Ω		$\pm 100 \Omega$			

^[1]Select 10 PLC.

Q: Quick performance verification test point.

Values for 34461A DMM							
Input	Function ^[1]	Range	Quick Check	Error from Nominal			
				24 hours	90 days	1 year	2 years
Open	DC Current	100 μ A	Q	$\pm 0.02 \mu$ A	$\pm 0.025 \mu$ A		
		1 mA		$\pm 0.060 \mu$ A			
		10 mA		$\pm 2 \mu$ A			
		100 mA		$\pm 4 \mu$ A	$\pm 5 \mu$ A		
		1 A		$\pm 60 \mu$ A	$\pm 100 \mu$ A		
		3 A		$\pm 600 \mu$ A			
		10 A		± 1 mA			
Short	DC Volts	100 mV	Q	$\pm 3 \mu$ V	$\pm 3.5 \mu$ V		
		1 V		$\pm 6 \mu$ V	$\pm 7 \mu$ V		
		10 V		$\pm 40 \mu$ V	$\pm 50 \mu$ V		
		100 V		$\pm 600 \mu$ V			
		1000 V		± 6 mV	± 10 mV		
Short	4-wire Ohms	100 Ω		± 3 m Ω	± 4 m Ω		
		1 k Ω		± 5 m Ω	± 10 m Ω		
		10 k Ω	Q	± 50 m Ω	± 100 m Ω		
		100 k Ω		± 500 m Ω	$\pm 1 \Omega$		
		1 M Ω		$\pm 10 \Omega$			
		10 M Ω		$\pm 100 \Omega$			

^[1]Select 10 PLC.

Q: Quick performance verification test point.

Values for 34465A DMM							
Input	Function ^[1]	Range	Quick Check	Error from Nominal			
				24 hours	90 days	1 year	2 years
Open	DC Current	1 μ A		± 50 pA (50E-12 A) ^[2]			
		10 μ A		± 200 pA (± 200.0 E-12 A) ^[2]			
		100 μ A	Q	± 0.001 μ A ^[2]			
		1 mA		± 0.030 μ A	± 0.050 μ A		
		10 mA		± 2 μ A			
		100 mA		± 4 μ A	± 5 μ A		
		1 A		± 60 μ A	± 100 μ A		
		3 A		± 600 μ A			
		10 A		± 1 ma			
Short	DC Volts	100 mV	Q	± 3 μ V	± 3.5 μ V		
		1 V		± 4 μ V			
		10 V		± 30 μ V	± 40 μ V		
		100 V		± 600 μ V			
		1000 V		± 6 mV			
Short	4-wire Ohms	100 Ω		± 3 m Ω	± 4 m Ω		
		1 k Ω		± 5 m Ω			
		10 k Ω	Q	± 50 m Ω			
		100 k Ω		± 500 m Ω			
		1 M Ω		± 5 Ω			
		10 M Ω		± 100 Ω			
Short	2-wire Ohms	100 M Ω		1 k Ω			

^[1]Select 10 PLC.

^[2]These values are typical and these ranges are calibrated internally.

Q: Quick performance verification test point.

Values for 34470A DMM							
Input	Function ^[1]	Range	Quick Check	Error from Nominal			
				24 hours	90 days	1 year	2 years
Open	DC Current	1 μ A		± 50 pA (50E-12 A) ^[2]			
		10 μ A		± 200 pA (± 200.0 E-12 A) ^[2]			
		100 μ A	Q	± 0.001 μ A ^[2]			
		1 mA		± 0.030 μ A	± 0.050 μ A		
		10 mA		± 2 μ A			
		100 mA		± 4 μ A	± 5 μ A		
		1 A		± 60 μ A	± 100 μ A		
		3 A		± 600 μ A			
		10 A		± 1 ma			
Short	DC Volts	100 mV	Q	± 3 μ V	± 3.5 μ V		
		1 V		± 4 μ V			
		10 V		± 20 μ V			
		100 V		± 600 μ V			
		1000 V		± 6 mV			
Short	4-wire Ohms	100 Ω		± 3 m Ω	± 4 m Ω		
		1 k Ω		± 5 m Ω			
		10 k Ω	Q	± 50 m Ω			
		100 k Ω		± 500 m Ω			
		1 M Ω		± 5 Ω			
		10 M Ω		± 100 Ω			
Short	2-wire Ohms	100 M Ω		1 k Ω			

^[1]Select 10 PLC.

^[2]These values are typical and these ranges are calibrated internally.

Q: Quick performance verification test point.

DC Volts and DC Current Gain Verification

This procedure verifies DC volts and DC current gain.

1. Make sure you have read **Test Considerations**.
2. Connect the calibrator to the input terminals. For the 34461A/65A/70A, use the front panel input terminals and select the front input terminals with the **Front/Rear** switch.
3. Configure each function and range in the order shown in the table below corresponding to the DMM model number. Provide the input shown in the table.
4. Make a measurement and return the result. Compare measurement results to the test limits shown below. (Be certain to allow for appropriate source settling.)

Values for 34460A DMM							
Input				Error from Nominal			
Voltage	Function ^[1]	Range	Quick Check	24 hours	90 days	1 year	2 years
100 mV	DC Volts	100 mV		± 10 µV	± 13.5 µV	± 15.5 µV	± 18 µV
-100 mV							
1 V		1 V		± 39 µV	± 70 µV	± 90 µV	± 115 µV
-1 V							
4 V		10 V		± 140 µV	± 250 µV	± 350 µV	± 450 µV
10 V		10 V	Q	± 290 µV	± 550 µV	± 800 µV	± 1.1 mV
-10 V							
100 V		100 V	Q	± 3.6 mV	± 7.1 mV	± 9.1 mV	± 11.6 mV
-100 V							
1000 V		1000 V		± 36 mV	± 75 mV	± 95 mV	± 120 mV
-500 V	± 21 mV						

^[1]Select 10 PLC.

Q: Quick performance verification test point.

Values for 34460A DMM							
Input				Error from Nominal			
Current	Function ^[1]	Range	Quick Check	24 hours	90 days	1 year	2 years
2 A	DC Current	3 A		± 4.2 mA	± 4.6 mA	± 4.6 mA	± 5.2 mA
1 A		1 A	Q	± 560 µA	± 900 µA	± 1.1 mA	± 1.3 mA
100 mA		100 mA		± 14 µA	± 35 µA	± 55 µA	± 65 µA
10 mA		10 mA	Q	± 2.7 µA	± 5 µA	± 7 µA	± 8 µA
1 mA		1 mA		± 0.13 µA	± 0.36 µA	± 0.56 µA	± 0.66 µA
100 µA		100 µA		± 0.03 µA	± 0.065 µA	± 0.075 µA	± 0.085 µA

^[1]Select 10 PLC.

Q: Quick performance verification test point.

Values for 34460A DMM							
Input				Error from Nominal			
Resistance	Function ^[1]	Range	Quick Check	24 hours	90 days	1 year	2 years
100 Ω	4-wire Ohms	100 Ω		± 10 m Ω	± 18 m Ω	± 21 m Ω	± 24 m Ω
1 k Ω		1 k Ω	Q	± 38 m Ω	± 120 m Ω	± 150 m Ω	± 180 m Ω
10 k Ω		10 k Ω		± 350 m Ω	± 1.2 Ω	± 1.5 Ω	± 1.8 Ω
100 k Ω		100 k Ω		± 3.5 Ω	± 12 Ω	± 15 Ω	± 18 Ω
1 M Ω		1 M Ω		± 40 Ω	± 120 Ω	± 150 Ω	± 180 Ω
10 M Ω		10 M Ω	Q	± 1.6 k Ω	± 2.1 k Ω	± 4.1 k Ω	± 6.1 k Ω
100 M Ω	2-wire Ohms	100 M Ω		± 310 k Ω	± 810 k Ω		

^[1]Select 10 PLC.

Q: Quick performance verification test point.

Values for 34461A DMM							
Input				Error from Nominal			
Voltage	Function ^[1]	Range	Quick Check	24 hours	90 days	1 year	2 years
100 mV	DC Volts	100 mV		± 6 μ V	± 7.5 μ V	± 8.5 μ V	± 10 μ V
-100 mV							
1 V		1 V		± 26 μ V	± 37 μ V	± 47 μ V	± 62 μ V
-1 V							
4 V		10 V		± 100 μ V	± 130 μ V	± 190 μ V	± 230 μ V
10 V			Q	± 190 μ V	± 250 μ V	± 400 μ V	± 500 μ V
-10 V		100 V		± 2.6 mV	± 4.1 mV	± 5.1 mV	± 6.6 mV
100 V			Q				
1000 V		1000 V		± 26 mV	± 45 mV	± 55 mV	± 70 mV
-500 V				± 16 mV	± 27.5 mV	± 32.5 mV	± 40 mV

^[1]Select 10 PLC.

Q: Quick performance verification test point.

Values for 34461A DMM							
Input				Error from Nominal			
Current	Function ^[1]	Range	Quick Check	24 hours	90 days	1 year	2 years
2 A	DC Current	3 A		± 4.2 mA	± 4.6 mA	± 4.6 mA	± 5.2 mA
1 A		1 A	Q	± 560 µA	± 900 µA	± 1.1 mA	± 1.3 mA
100 mA		100 mA		± 14 µA	± 35 µA	± 55 µA	± 65 µA
10 mA		10 mA	Q	± 2.7 µA	± 5 µA	± 7 µA	± 8 µA
1 mA		1 mA		± 0.13 µA	± 0.36 µA	± 0.56 µA	± 0.66 µA
100 µA		100 µA		± 0.03 µA	± 0.065 µA	± 0.075 µA	± 0.085 µA

^[1]Select 10 PLC.

Q: Quick performance verification test point.

Values for 34461A DMM							
Input				Error from Nominal			
Resistance	Function ^[1]	Range	Quick Check	24 hours	90 days	1 year	2 years
100 Ω	4-wire Ohms	100 Ω		± 6 mΩ	± 12 mΩ	± 14 mΩ	± 16 mΩ
1 kΩ		1 kΩ	Q	± 25 mΩ	± 90 mΩ	± 110 mΩ	± 130 mΩ
10 kΩ		10 kΩ		± 250 mΩ	± 900 mΩ	± 1.1 Ω	± 1.3 Ω
100 kΩ		100 kΩ		± 2.5 Ω	± 9 Ω	± 11 Ω	± 13 Ω
1 MΩ		1 MΩ		± 30 Ω	± 90 Ω	± 110 Ω	± 130 Ω
10 MΩ		10 MΩ	Q	± 1.6 kΩ	± 2.1 kΩ	± 4.1 kΩ	± 6.1 kΩ
100 MΩ	2-wire Ohms	100 MΩ		± 310 kΩ	± 810 kΩ		

^[1]Select 10 PLC.

Q: Quick performance verification test point.

Values for 34465A DMM							
Input				Error from Nominal			
Current	Function ^[1]	Range	Quick Check	24 hours	90 days	1 year	2 years
2 A	DC Current	3 A		± 4.2 mA	± 4.6 mA	± 4.6 mA	± 5.2 mA
1 A		1 A	Q	± 560 µA	± 800 µA	± 900 µA	± 1.1 mA
100 mA		100 mA		± 14 µA	± 35 µA	± 55 µA	± 65 µA
10 mA		10 mA	Q	± 2.7 µA	± 5 µA	± 7 µA	± 8 µA
1 mA		1 mA		± 0.1 µA	± 0.35 µA	± 0.55 µA	± 0.65 µA

^[1]Select 10 PLC.

Q: Quick performance verification test point.

Values for 34465A DMM								
Input				Error from Nominal				
Voltage	Function ^[1]	Range	Quick Check	24 hours	90 days	1 year	2 years	
100 mV	DC Volts	100 mV		± 6 µV	± 7.5 µV	± 8.5 µV	± 10 µV	
-100 mV								
1 V		1 V		± 19 µV	± 29 µV	± 39 µV	± 54 µV	
-1 V								
4 V		10 V			± 70 µV	± 120 µV	± 160 µV	± 220 µV
10 V				Q	± 130 µV	± 240 µV	± 340 µV	± 490 µV
-10 V								
100 V			100 V		± 2.6 mV	± 4.1 mV	± 4.6 mV	± 6.1 mV
-100 V		Q						
1000 V		1000 V			± 36 mV	± 51 mV	± 56 mV	± 71 mV
-500 V					± 16 mV	± 23.5 mV	± 26 mV	± 33.5 mV

^[1]Select 10 PLC.

Q: Quick performance verification test point.

Values for 34465A DMM							
Input				Error from Nominal			
Resistance	Function ^[1]	Range	Quick Check	24 hours	90 days	1 year	2 years
100 Ω	4-wire Ohms	100 Ω		± 6 mΩ	± 9 mΩ	± 10 mΩ	± 11 mΩ
1 kΩ		1 kΩ	Q	± 25 mΩ	± 35 mΩ	± 45 mΩ	± 55 mΩ
10 kΩ		10 kΩ		± 250 mΩ	± 350 mΩ	± 450 mΩ	± 550 mΩ
100 kΩ		100 kΩ		± 2.5 Ω	± 3.5 Ω	± 4.5 Ω	± 5.5 Ω
1 MΩ		1 MΩ		± 25 Ω	± 65 Ω	± 75 Ω	± 85 Ω
10 MΩ		10 MΩ		± 1.1 kΩ	± 2.1 kΩ	± 2.6 kΩ	± 3.1 kΩ
10 MΩ	2-wire Ohms	10 MΩ	Q				
100 MΩ		100 MΩ		± 101 kΩ	± 201 kΩ	± 301 kΩ	± 401 kΩ

^[1]Select 10 PLC.

Q: Quick performance verification test point.

Values for 34470A DMM							
Input				Error from Nominal			
Current	Function ^[1]	Range	Quick Check	24 hours	90 days	1 year	2 years
2 A	DC Current	3 A		± 4.2 mA	± 4.6 mA		± 5.2 mA
1 A		1 A	Q	± 560 µA	± 800 µA	± 900 µA	± 1.1 mA
100 mA		100 mA		± 14 µA	± 35 µA	± 55 µA	± 65 µA
10 mA		10 mA	Q	± 2.7 µA	± 5 µA	± 7 µA	± 8 µA
1 mA		1 mA		± 0.1 µA	± 0.35 µA	± 0.55 µA	± 0.65 µA

[1]Select 10 PLC.

Q: Quick performance verification test point.

Values for 34470A DMM								
Input				Error from Nominal				
Voltage	Function ^[1]	Range	Quick Check	24 hours	90 days	1 year	2 years	
100 mV	DC Volts	100 mV		± 6 µV	± 7.5 µV		± 8 µV	
-100 mV								
1 V		1 V		± 14 µV	± 19 µV	± 24 µV	± 29 µV	
-1 V								
4 V		10 V		± 52 µV	± 72 µV	± 84 µV	± 100 µV	
10 V			Q	± 100 µV	± 150 µV	± 180 µV	± 220 µV	
-10 V								
100 V		100 V			± 2.6 mV	± 3.8 mV	± 4.4 mV	± 4.6 mV
-100 V			Q					
1000 V		1000 V			± 36 mV	± 48 mV	± 54 mV	± 56 mV
-500 V				± 16 mV	± 22 mV	± 25 mV	± 36 mV	

[1]Select 10 PLC.

Q: Quick performance verification test point.

Values for 34470A DMM							
Input				Error from Nominal			
Resistance	Function ^[1]	Range	Quick Check	24 hours	90 days	1 year	2 years
100 Ω	4-wire Ohms	100 Ω		± 6 mΩ	± 9 mΩ	± 10 mΩ	± 11 mΩ
1 kΩ		1 kΩ	Q	± 25 mΩ	± 35 mΩ	± 45 mΩ	± 55 mΩ
10 kΩ		10 kΩ		± 250 mΩ	± 350 mΩ	± 450 mΩ	± 550 mΩ
100 kΩ		100 kΩ		± 2.5 Ω	± 3.5 Ω	± 4.5 Ω	± 5.5 Ω
1 MΩ		1 MΩ		± 25 Ω	± 65 Ω	± 75 Ω	± 85 Ω
10 MΩ		10 MΩ			± 1.1 kΩ	± 2.1 kΩ	± 2.6 kΩ
10 MΩ	2-wire Ohms	10 MΩ	Q				
100 MΩ		100 MΩ		± 101 kΩ	± 201 kΩ	± 301 kΩ	± 401 kΩ

[1]Select 10 PLC.

Q: Quick performance verification test point.

Frequency Accuracy Verification

Configuration: Frequency (CONFigure:FREQUENCY DEF, MIN)

1. Make sure you have read **Test Considerations**.
2. Select the Frequency function, default range, 3 Hz filter, and 1 second aperture.
3. Connect the Keysight 33500B Series Function/Arbitrary Waveform Generator to the input terminals. For the 34461A/65A/70A, use the front panel input terminals and select the front input terminals with the **Front/Rear** switch.
4. Select each range in the order shown below. Provide the indicated input voltage and frequency. Compare measurement results to the test limits shown below. (Be certain to allow for appropriate source settling.)

Values for 34460A DMM							
Input				Error from Nominal			
Vrms	Frequency	Range	Quick Check	24 hours	90 days	1 year	2 years
0.1 Vrms	10 Hz	1 Vrms		± 3 mHz			± 3.5 mHz
0.01 Vrms	300 kHz	0.1 Vrms	Q	± 60 Hz	± 240 Hz	± 360 Hz	± 510 Hz

Values for 34461A DMM							
Input				Error from Nominal			
Vrms	Frequency	Range	Quick Check	24 hours	90 days	1 year	2 years
0.1 Vrms	10 Hz	1 Vrms		± 3 mHz			± 3.5 mHz
0.01 Vrms	300 kHz	0.1 Vrms	Q	± 60 Hz	± 180 Hz	± 300 Hz	± 450 Hz

Values for 34465A and 34470A DMMs							
Input				Error from Nominal			
Vrms	Frequency	Range	Quick Check	24 hours	90 days	1 year	2 years
0.1 Vrms	10 Hz	1 Vrms		± 3 mHz			
0.01 Vrms	300 kHz	0.1 Vrms	Q	± 60 Hz	± 150 Hz	± 210 Hz	± 270 Hz

Q: Quick performance verification test point.

AC Voltage and AC Current Verification

This procedure verifies AC voltage and current.

1. Make sure you have read **Test Considerations**.
2. Connect the calibrator to the input terminals. For the 34461A/65A/70A, use the front panel input terminals and select the front input terminals with the **Front/Rear** switch.
3. Set the AC Volts or AC Current function and the filter as shown below.
4. Select each range in the order shown below. Provide the indicated input voltage and frequency. Compare measurement results to the test limits shown below. (Be certain to allow for appropriate source settling.)

ACV Values for 34460A DMM								
Input					Error from Nominal			
Vrms	Frequency	Range	Filter	Quick Check	24 hours	90 days	1 year	2 years
100 mV	1 kHz	100 mV	200 Hz		± 90 µV	± 110 µV	± 120 µV	± 130 µV
	50 kHz				± 170 µV	± 190 µV	± 200 µV	± 210 µV
	300 kHz			Q	± 4.5 mV			
1 V	1 kHz	1 V	200 Hz		± 900 µV	± 1.1 mV	± 1.2 mV	± 1.3 mV
	50 kHz				± 1.7 mV	± 1.9 mV	± 2 mV	± 2.1 mV
	300 kHz				± 45 mV			
0.03 V	1 kHz	10 V	200 Hz		± 2 mV	± 3 mV		
1 V	1 kHz		200 Hz		± 2.7 mV	± 3.8 mV	± 3.9 mV	± 4 mV
10 V	10 Hz		3 Hz		± 9 mV	± 11 mV	± 12 mV	± 13 mV
	100 Hz		20 Hz		± 9 mV	± 11 mV	± 12 mV	± 13 mV
	20 kHz		200 Hz		± 9 mV	± 11 mV	± 12 mV	± 13 mV
	50 kHz		200 Hz	Q	± 17 mV	± 19 mV	± 20 mV	± 21 mV
	100 kHz				± 66 mV	± 71 mV		
300 kHz				± 450 mV				
100 V	1 kHz	100 V	200 Hz	Q	± 90 mV	± 110 mV	± 120 mV	± 130 mV
	50 kHz				± 170 mV	± 190 mV	± 200 mV	± 210 mV
70 V	300 kHz				± 3.3 V			
750 V	1 kHz	750 V	200 Hz		± 675 mV	± 825 mV	± 900 mV	± 975 mV
210 V	50 kHz				± 573 mV	± 669 mV	± 690 mV	± 711 mV
70 V	300 kHz					± 6.6 V		

Q: Quick performance verification test point.

ACV Values for 34461A DMM								
Input					Error from Nominal			
Vrms	Frequency	Range	Filter	Quick Check	24 hours	90 days	1 year	2 years
100 mV	1 kHz	100 mV	200 Hz		± 60 µV	± 80 µV	± 90 µV	± 100 µV
	50 kHz				± 140 µV	± 160 µV	± 170 µV	± 180 µV
	300 kHz			Q	± 4.5 mV			
1 V	1 kHz	1 V	200 Hz		± 600 µV	± 800 µV	± 900 µV	± 1 mV
	50 kHz				± 1.4 mV	± 1.6 mV	± 1.7 mV	± 1.8 mV
	300 kHz				± 45 mV			
0.03 V	1 kHz	10 V	200 Hz		± 2 mV	± 3 mV		
1 V	1 kHz		200 Hz		± 2.4 mV	± 3.5 mV	± 3.6 mV	± 3.7 mV
10 V	10 Hz		3 Hz		± 6 mV	± 8 mV	± 9 mV	± 10 mV
	100 Hz		20 Hz		± 6 mV	± 8 mV	± 9 mV	± 10 mV
	20 kHz		200 Hz		± 6 mV	± 8 mV	± 9 mV	± 10 mV
	50 kHz		200 Hz	Q	± 14 mV	± 16 mV	± 17 mV	± 18 mV
	100 kHz				± 63 mV	± 68 mV		
300 kHz				± 450 mV				
100 V	1 kHz	100 V	200 Hz	Q	± 60 mV	± 80 mV	± 90 mV	± 100 mV
	50 kHz				± 140 mV	± 160 mV	± 170 mV	± 180 mV
70 V	300 kHz				± 3.3 V			
750 V	1 kHz	750 V	200 Hz		± 450 mV	± 600 mV	± 675 mV	± 750 mV
210 V	50 kHz				± 510 mV	± 606 mV	± 627 mV	± 648 mV
70 V	300 kHz					± 6.6 V		

Q: Quick performance verification test point.

Performance Verification

ACI Values for 34460A and 34461A DMMs								
Input				Error from Nominal				
Current, rms	Frequency	Range	Filter	Quick Check	24 hours	90 days	1 year	2 years
2 A	1 kHz	3 A	200 Hz		± 5.8 mA			
	5 kHz							
1 A	1 kHz	1 A	200 Hz		± 1.4 mA			
	5 kHz							
100 mA	10 Hz	100 mA	3 Hz		± 140 µA			
	1 kHz		200 Hz					
	5 kHz		200 Hz					
100 µA	1 kHz	10 mA	200 Hz		4.1 µA			
1 mA	1 kHz				5 µA			
10 mA	1 kHz				14 µA			
	5 kHz							
1 mA	1 kHz	1 mA	200 Hz		1.4 µA			
	5 kHz							
100 µA	1 kHz	100 µA	200 Hz	Q	0.14 µA			
	5 kHz							

Q: Quick performance verification test point.

ACV Values for 34465A and 34470A DMMs									
Input					Error from Nominal				
Vrms	Frequency	Range	Filter	Quick Check	24 hours	90 days	1 year	2 years	
100 mV	1 kHz	100 mV	200 Hz		± 40 µV	± 60 µV	± 70 µV	± 80 µV	
	50 kHz				± 80 µV	± 90 µV	± 100 µV	± 110 µV	
	300 kHz			Q	± 1.1 mV				
1 V	1 kHz	1 V	200 Hz		± 400 µV	± 600 µV	± 700 µV	± 800 µV	
	50 kHz				± 800 µV	± 900 µV	± 1 mV	± 1.1 mV	
	300 kHz				± 11 mV				
0.03 V	1 kHz	10 V	200 Hz		± 2 mV				
1 V	1 kHz		200 Hz		± 2.2 mV	± 2.4 mV	± 2.5 mV	± 2.6 mV	
10 V	10 Hz		3 Hz			± 4 mV	± 6 mV	± 7 mV	± 8 mV
	100 Hz		20 Hz						
	20 kHz		200 Hz						
	50 kHz		Q		± 8 mV	± 9 mV	± 10 mV	± 11 mV	
100 kHz	200 Hz		± 20 mV						
300 kHz		± 110 mV							
100 V	1 kHz	100 V	200 Hz	Q	± 40 mV	± 60 mV	± 70 mV	± 80 mV	
	50 kHz				± 80 mV	± 90 mV	± 100 mV	± 110 mV	
70 V	300 kHz				± 800 mV				
750 V	1 kHz	750 V	200 Hz		± 750 mV	± 900 mV	± 975 mV	± 1.1 V	
210 V	50 kHz				± 330 mV	± 351 mV	± 372 mV	± 393 mV	
70 V	300 kHz				± 1.5 V				

Q: Quick performance verification test point.

ACI Values for 34465A and 34470A DMMs								
Input					Error from Nominal			
Current, rms	Frequency	Range	Filter	Quick Check	24 hours	90 days	1 year	2 years
2 A	1 kHz	3 A	200 Hz		± 5.8 mA			
	5 kHz							
1 A	1 kHz	1 A	200 Hz		± 1.1 mA	± 1.3 mA	± 1.4 mA	
	5 kHz							
100 mA	10 Hz	100 mA	3 Hz		± 110 µA	± 130 µA	± 140 µA	
	1 kHz		200 Hz					
	5 kHz		200 Hz	Q				
100 µA	1 kHz	10 mA	200 Hz		± 4.1 µA			
1 mA	1 kHz				± 4.7 µA	± 4.9 µA	± 5 µA	
10 mA	1 kHz				± 11 µA	± 13 µA	± 14 µA	
	5 kHz							
1 mA	1 kHz	1 mA	200 Hz	Q	± 1.1 µA	± 1.3 µA	± 1.4 µA	
	5 kHz							
100 µA	1 kHz	100 µA	200 Hz		± 0.110 µA	± 0.130 µA	± 0.140 µA	
	5 kHz							

Q: Quick performance verification test point.

High Current Verification

This procedure applies to the 34461A, 34465A, and 34470A only (not applicable to the 34460A).

This procedure verifies AC and DC current on the 10 A terminals.

1. Make sure you have read **Test Considerations**.
2. Connect the calibrator to the front 10 A input terminals and select the Front input terminals with the **Front/Rear** switch.
3. Select each function in the order shown below. Provide the indicated input current and frequency, and for ACI, use the 200 Hz input filter. Compare measurement results to the test limits shown below. (Be certain to allow for appropriate source settling.)

Values for the 34461A, 34465A, and 34470A DMMs								
Input				Quick Check	Error from Nominal			
Function	Current [1]	Frequency	Range		24 hours	90 days	1 year	2 years
DCI	5 A	N/A	10 A		± 3.5 mA	± 7 mA		± 8.5 mA
DCI	10 A	N/A	10 A	Q	± 16 mA	± 23 mA		± 26 mA
ACI	10 A	5 kHz	10 A		± 24 mA (34465A/70A) ± 29 mA (34461A)	± 29 mA		

^[1] If you are NOT using the Fluke 5725 for calibration, reduce the current to 2 A.

Capacitance Verification (Optional Verification Test)

This optional procedure verifies capacitance accuracy.

1. Make sure you have read **Test Considerations**.
2. Select the Capacitance measurement function.
3. Connect the capacitance calibrator to the front input terminals and select the front input terminals with the Front/Rear switch.
4. Select each range in the order shown below. Provide the indicated input.
5. Compare measurement results to the test limits shown in the table. (Be certain to allow time for source settling.)

Input		
Capacitance	Range	Error from Nominal
1 μ F	1 μ F	$\pm 0.005 \mu$ F
1 μ F	10 μ F	$\pm 0.014 \mu$ F

Calibration Adjustment Procedures

You will need a test input cable and connectors set and a low thermal input short, Keysight 34172B, to calibrate the instrument (see [Input Connections](#)). Two input shorts are recommended for the 34461A/65A/70A.

- [Calibration Process Overview](#)
- [34460A and 34461A Calibration Procedures](#)
- [34465A and 34470A Calibration Procedures](#)

Calibration Procedures

This section contains procedures for adjusting the instrument's performance (calibration).

NOTE

There is no separate calibration for Diode or Continuity, because these functions are based on the resistance measurement, which is calibrated. Also, there is no calibration for gate time because this functionality is controlled by digital logic. There is no calibration for capacitance gain and, for the 34465A and 34470A, no calibration on the 1, 10, and 100 μA DCI ranges

Use one of the following sets of procedures based on the DMM model number:

- [34460A and 34461A Calibration Procedures](#)
- [34465A and 34470A Calibration Procedures](#)

Closed-Case Electronic Calibration

The instrument uses closed-case electronic calibration; no internal mechanical adjustments are required. The instrument calculates correction factors based on reference signals that you apply and stores the correction factors in non-volatile memory. This data is not changed by cycling power, ***RST**, or **SYSTem:PRESet**.

Keysight Technologies Calibration Services

Keysight Technologies offers calibration services using automated calibration systems that enable Keysight to provide calibration at competitive prices. See [Types of Service Available](#) for information on contacting Keysight.

Calibration Adjustment Interval

The instrument should be calibrated on a regular interval determined by the accuracy requirements of your application. A 1-year interval is adequate for most applications. Accuracy specifications are warranted only if calibration is made at regular calibration intervals. Keysight Technologies never recommends calibration adjustment intervals beyond two years.

Calibration is Recommended

Whatever calibration interval you select, Keysight Technologies recommends that complete re-calibration should always be performed at the calibration interval. This ensures that the instrument will remain within specifications for the next calibration interval and provides the best long-term stability. Performance data measured during performance verification tests does not mean that the instrument will remain within these limits unless the calibration adjustments are performed. Use the calibration count to verify that all calibration adjustments have been performed.

Time Required for Calibration Adjustment

The instrument can be automatically calibrated under computer control, including complete calibration adjustment procedure and performance verification tests, in less than 30 minutes once the instrument is warmed-up (see Test Considerations).

Automating Calibration Adjustment Procedures

The calibration procedures demonstrate front panel calibration. You can automate the complete verification and calibration procedures outlined in this manual. You can program the instrument configurations specified for each test over the remote interface. You can then enter read back verification data into a test program and compare the results to the appropriate test limit values.

The instrument must be unsecured to calibrate. See [Calibration Security](#) for details.

Refer to the [CALibration Subsystem](#) for information on SCPI programming.

Input Connections

Test connections to the instrument are best accomplished using a Keysight Technologies 34172B calibration short for low-thermal offset measurements and a 34171B DMM connector configured to interface to the calibrator output. Shielded, twisted-pair, PTFE interconnect cables of minimum length are recommended between the calibrator and the multimeter to reduce settling and noise errors. HI and HI Sense should be a twisted pair. LO and LO Sense should be a twisted pair. Cable shields should be earth ground referenced. This configuration is recommended for noise reduction and settling time performance during calibration.

Test Considerations

Errors may be induced by AC signals present on the input leads during a self-test. Long test leads can also act as an antenna causing pick-up of AC signals.

For optimum performance:

- Ensure that the calibration ambient temperature (T_{cal}) is stable and between 18 °C and 28 °C. Ideally the calibration should be performed at 23 °C \pm 2 °C.
- Ensure ambient relative humidity is less than 80%.
- Allow a 90 minutes (or 180 minutes for 34470A) warm-up period with a copper short connected.
- Connect the input cable shields to earth ground. Except where noted in the procedures, connect the calibrator LO source to earth ground at the calibrator. It is important that the LO to earth ground connection be made at only one place in the circuit to avoid ground loops.

Because the instrument is capable of making highly accurate measurements, you must take care to ensure that the calibration standards and test procedures do not introduce additional errors. Ideally, the standards used to verify and adjust the instrument should be an order of magnitude more accurate than each instrument range full scale error specification.

For 2-wire ohms measurements, remove lead resistance by doing a null measurement with the leads shorted or with a precision 4-terminal low thermal short. For offset calibration a 4-terminal low thermal short is required.

Recommended Test Equipment

The recommended test equipment for the performance verification and calibration is listed below. If the exact instrument is not available, substitute calibration standards of equivalent accuracy.

An alternate method is to use the Keysight 3458A 8½-digit Digital Multimeter to measure less accurate, yet stable, sources. The output value measured from the source can be entered into the instrument as the target calibration value.

Application	Recommended Equipment
Zero Calibration	Keysight 34172B
DC Voltage	Fluke 5720A
DC Current	Fluke 5720A
Resistance	Fluke 5720A
AC Voltage	Fluke 5720A
AC Current	Fluke 5720A
Frequency	Keysight 33500B Series Function/Arbitrary Waveform Generator
High Current	Fluke 5725A
Capacitance (Optional)	SCA-1uF Capacitance Standard

Calibration Adjustment Process

The following general procedure is recommended to complete a full calibration adjustment.

1. Read [Test Considerations](#).
2. Perform the [performance verification tests](#) to characterize the instrument (incoming data).
3. Unsecure the instrument for calibration (see [Calibration Security](#)).
4. Perform the calibration procedures (see [Calibration Procedures](#)).
5. Secure the instrument against calibration (see [Calibration Security](#)).
6. Note the security code and calibration count in the instrument's maintenance records.
7. Perform the [performance verification tests](#) to verify the calibration.

Gain Calibration Adjustment Overview

The ADC and zero calibration adjustment procedure must have been recently performed before beginning gain calibration. Gain calibrations can be made using either the front or rear input (not available on the 34460A) terminals. On the 34461A/65A/70A, make sure the **Front/Rear** switch matches the terminals in use.

CAUTION Never turn off the instrument during a gain or flatness calibration. This may cause calibration memory for the present function to be lost.

Valid Gain and Flatness Calibration Input Values

Gain calibration can be accomplished using the following input values.

Function	Range	Valid Amplitude Input Values
DC Volts	100 mV to 100 V	0.9 to 1.1 x Full Scale
	1000 V	450 to 1000 V
DC Current	100 μ A to 1 A	0.9 to 1.1 x Full Scale
	3 A	1.5 A to 2.5 A
	10 A	1.8 A to 10 A
Ohms (2W and 4W)	100 Ω to 100 M Ω	0.9 to 1.1 x Full Scale
Frequency	Auto	Input > 100 mV rms, 9.9 kHz to 110 kHz
AC Current (rms) ^[1]	100 μ A to 1 A	0.9 to 1.1 x Full Scale
	3 A	0.9 A to 2 A
	10 A	2 A to 10 A
AC Volts (rms) ^[1]	100 mV to 10 V	0.9 to 1.1 x Full Scale
	100 V	40 V to 110 V
	750 V	400 to 750 V

^[1] Valid frequencies are nominal frequencies $\pm 1\%$.

Gain and Flatness Calibration Adjustment Overview

The instrument stores new flatness correction constants each time this procedure is followed. Flatness constants adjust the DMM for AC Volts and AC current measurements across the usable input frequency band. The flatness constant is computed from the calibration value entered for the calibration command and from measurements made automatically during the calibration procedure.

Calibrations for each range and frequency should be performed in the order shown.

Flatness Calibration Considerations

The ADC and zero calibration adjustment procedure must have been recently performed before beginning gain calibration. Flatness calibrations can be made using either the front or the rear input terminals. On the 34461A/65A/70A, make sure the **Front/Rear** switch matches the terminals in use.

CAUTION Never turn off the instrument during a gain or flatness calibration. This may cause calibration memory for the present function to be lost.

Gain Calibration

The instrument calculates and stores gain corrections for each input value. The gain constant is computed from the calibration value entered for the calibration command and from measurements made automatically during the calibration procedure.

Most measurement functions and ranges have gain calibration procedures, and calibration for each function should be performed in the order shown.

Entering Calibration Values and Storing Calibration Constants

Selecting the Calibration Mode

Use the CALibration:ADC? query to begin ADC calibration. The response to this query indicates a successful calibration (0) or a failure (1). Following the ADC calibration, use the measurement commands to set the DMM measurement parameters and functions for the mode being calibrated.

Front Panel: [Utility] > Test/Admin > Calibrate > Perform Cal > Cal Value > Perform ADC Cal

Entering Calibration Values

To enter a calibration value from the remote interface use CALibration:VALue <value> followed by the CALibration? query. The response to the query indicates whether the calibration is valid.

Front Panel: [Utility] > Test/Admin > Calibrate > Perform Cal > Cal Value > (enter value) > Perform Cal Step

Storing the Calibration Constants

To store calibration values in non-volatile memory, use CALibration:STORe.

Front Panel: [Utility] > Test/Admin > Calibrate > Save Cal Values

NOTE You must have performed a successful calibration immediately before pressing **Save Cal Values**.

Calibration Security

This section describes the instrument's calibration security system. If you forget the security code, you can **override calibration security**.

Security Overview

A security code (calibration password) prevents accidental or unauthorized instrument calibration.

- When shipped from the factory, the instrument is secured, with the security code (calibration password) set to **AT3446XA**.
- The same security code must be used for front panel and remote operation. If you secure the instrument from the front panel, use that same code to unsecure it from the remote interface.
- This setting is non-volatile; it will not be changed by power cycling or ***RST** or **SYSTem:PRESet**.
- Security code rules:
 - Unquoted string up to 12 characters
 - Must start with letter (A-Z)
 - May contain letters, numbers (0-9) and underscores
- **Front Panel:** [Utility] > Test / Admin > Security
- **SCPI:** **CALibration:SECure:STATe**

Calibration Message

You can store a message of up to 40 characters in calibration memory. For example, you could store the date of the last calibration, the date the next calibration is due, or the name and phone number of the person responsible for calibration.

To read the calibration message, press **Utility > Test/Admin > Calibrate** or send **CALibration:STRing?** from the remote interface.

To change the calibration message, unsecure the instrument and press **Utility > Test/Admin > Calibrate > Edit Cal String** or send **CALibration:STRing "<string>"** from the remote interface.

Calibration Count

You can query the instrument to determine how many calibrations have been performed. Because the value increments each time you store the calibration constants, a complete calibration adds many counts. The calibration count also increments whenever you save a calibration string, change the calibration password, or override the calibration security.

Your instrument was calibrated at the factory. When you receive your instrument, be sure to read the count to determine its initial value.

To read the calibration count, press **[Utility] > Test/Admin > Calibrate** on the front panel or send **CALibration:COUNT?** from the remote interface. You can read the calibration count regardless of whether the instrument is secured.

Aborting a Calibration in Progress

Sometimes it may be necessary to abort a calibration. You can abort a calibration at any time on any module by turning off the power or issuing a remote interface device clear message.

CAUTION

If you abort a calibration in progress when the instrument is attempting to write new calibration constants to EEPROM, you may lose all calibration constants for the function. Typically, upon re-applying power, the instrument will report error 705 Cal:Aborted. It may also generate errors 740 through 742. If this occurs, you should not use the instrument until a complete re-calibration has been performed. See the [list of calibration errors](#) for more information.

Security Code Override

The instrument security code (calibration password) is set to AT3446XA at the factory. If it has been changed and you no longer remember the code, you can reset the code back to its factory default value by using one of the two following procedures.

Which Procedure Should I Use?

From the instrument front panel, press **[Shift]** > **[Help]** > **About** to view the instrument firmware revision. An example display is:

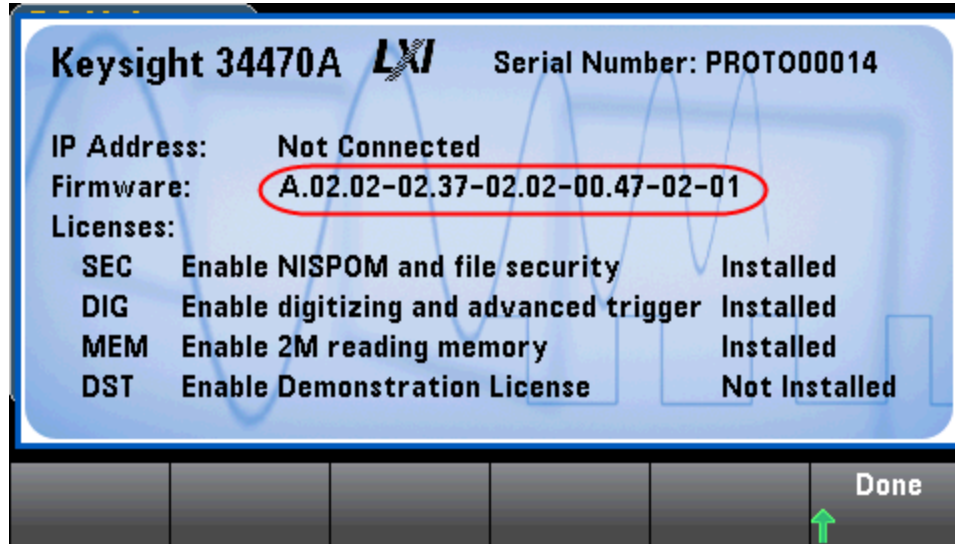

The last two digits of the firmware revision indicate the front panel PC board revision and which of the two procedures you should use. If the firmware revision ends with 02 or greater, use **Procedure A**. If the firmware revision ends with 01, use **Procedure B**.



If you encounter problems, contact Keysight Technologies for technical support.

In the United States: (800) 829-4444

In Europe: 31 20 547 2111

In Japan: 0120-421-345

Use www.keysight.com/find/assist to contact Keysight worldwide, or contact your Keysight Technologies representative.

Procedure A: For Firmware Revision Ending in 02, or Greater

WARNING

This procedure should be performed by qualified service personnel only. Turn off the power and remove all measurement leads and other cables, including the power cord, from the instrument before continuing.

1. Follow the [disassembly procedure](#) to disassemble the instrument.
2. Locate connector J102 on the front panel board. Short pin A1 to B1 as shown by the orange line below.

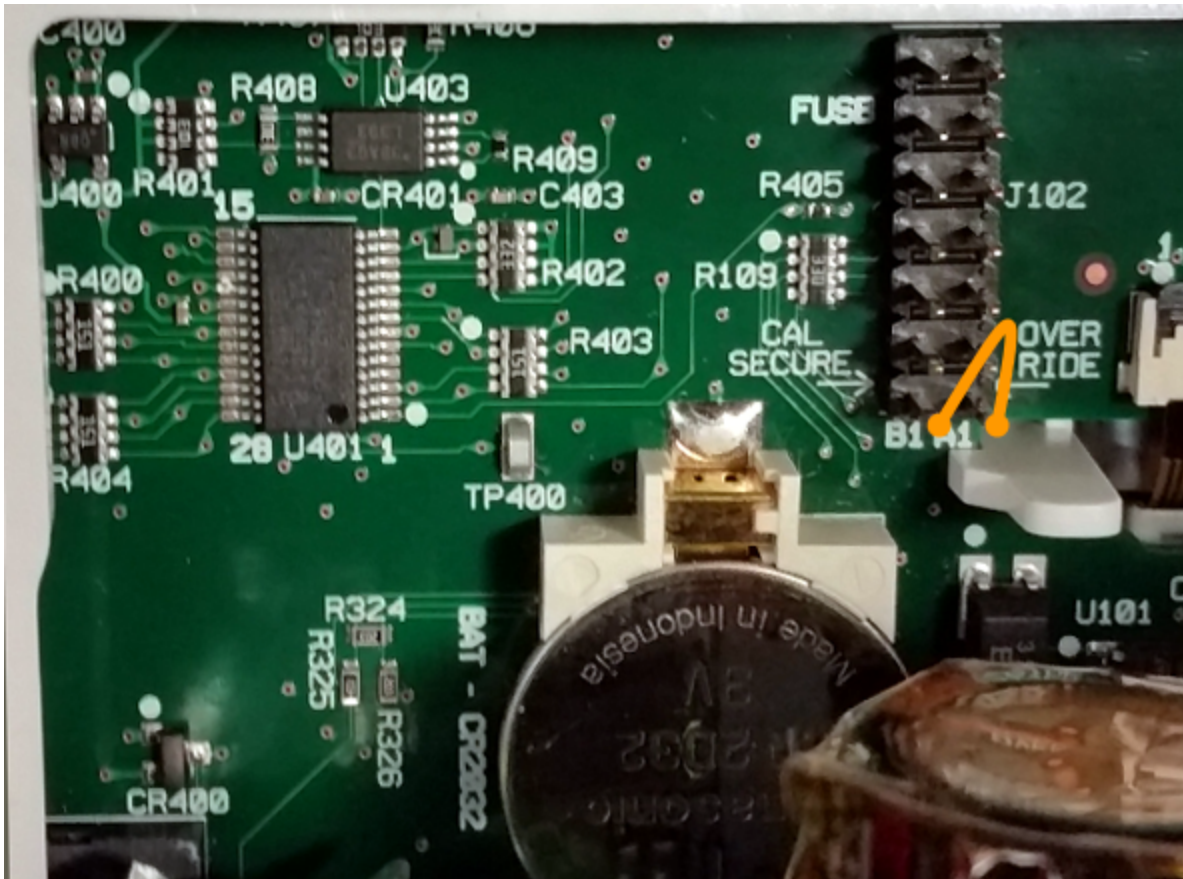

3. Reassemble the instrument, apply power and turn it on; the instrument will generate an error and beep (this is normal). Wait 30 to 40 seconds for the instrument to power up completely.
4. Reset the security code to the factory default:
 - a. Press **[Shift] > [Utility] > Test / Admin > Security > New Code**.
 - b. Enter AT3446XA as the new passcode.
 - c. Press **Done**.
 - d. Verify the new code and press **Yes** to confirm the change.

5. Remove power, disassemble the instrument, and remove the short. Then reassemble the instrument to complete the security code (calibration password) reset procedure.

Procedure B: For Firmware Revision Ending in 01

WARNING

This procedure should be performed by qualified service personnel only. Turn off the power and remove all measurement leads and other cables, including the power cord, from the instrument before continuing.

1. Follow the [disassembly procedure](#) to disassemble the instrument.
2. Locate connector J102 on the front panel board. Short pin A1 to A6 or A7 as shown by the orange lines below. You do not need to short both pins to A1, just one of them.

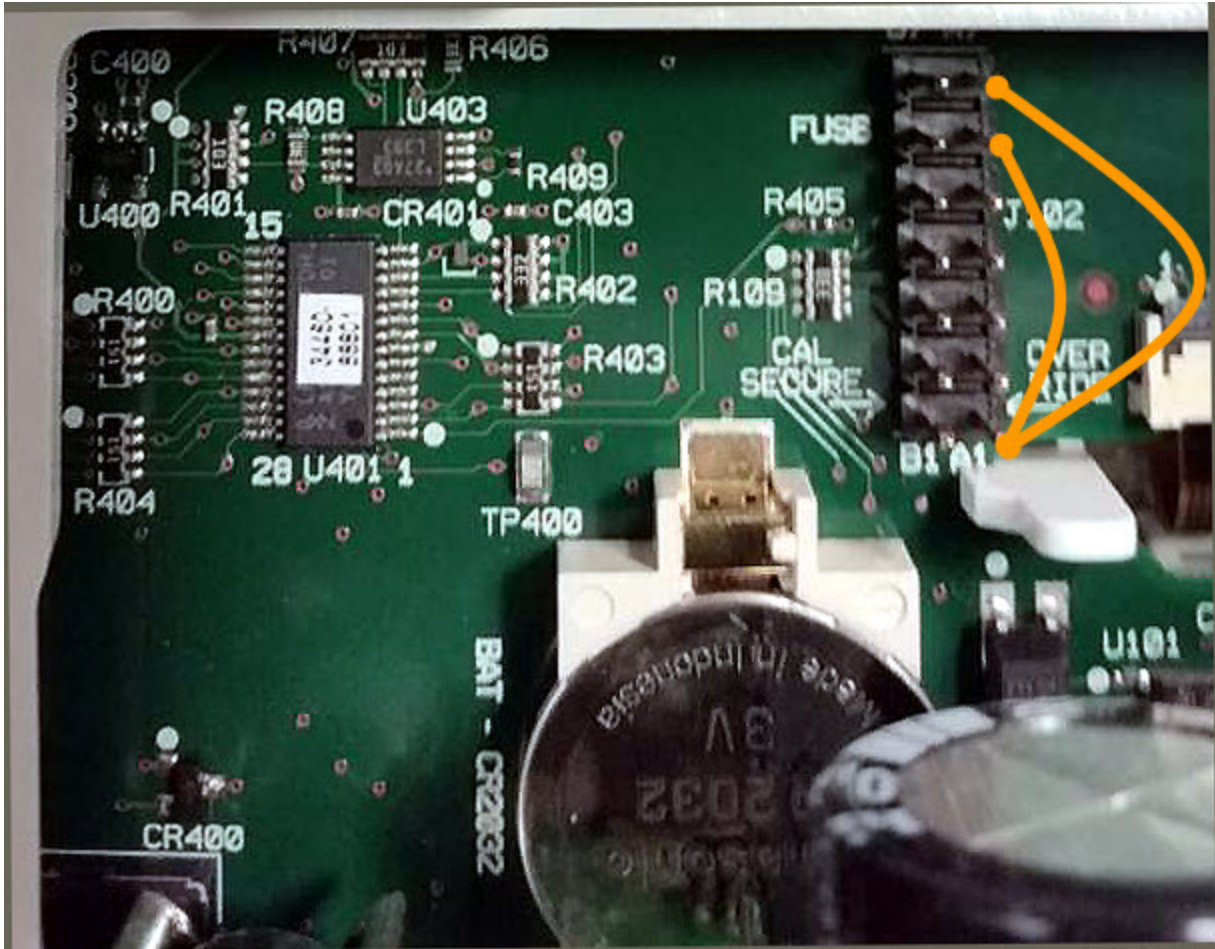

3. Reassemble the instrument, apply power and turn it on; the instrument will generate an error and beep (this is normal). Wait 30 to 40 seconds for the instrument to power up completely.

4. Reset the security code to the factory default:
 - a. Press **[Shift]** > **[Utility]** > **Test / Admin** > **Security** > **New Code**.
 - b. Enter AT3446XA as the new passcode.
 - c. Press **Done**.
 - d. Verify the new code and press **Yes** to confirm the change.
5. Remove power, disassemble the instrument, and remove the short. Then reassemble the instrument to complete the security code (calibration password) reset procedure.

34460A and 34461A Calibration Procedures

The following calibration procedures apply only to the 34460A and 34461A DMMs. Perform the calibration procedures in the order listed in this document. Use the arrow links at the bottom of every page to go to the next calibration procedure.

1. [ADC and Zero Calibration Procedure](#)
2. [AC Voltage Low Freq Gain and Flatness Cal](#)
3. [AC Voltage Gain and Flatness Calibration](#)
4. [AC Current Gain and Flatness Calibration](#)
5. [AC Zero Calibration](#)
6. [Frequency Accuracy Calibration](#)
7. [DC Voltage Gain Calibration](#)
8. [Ohms Gain Calibration](#)
9. [DC Current Gain Calibration](#)
10. [AC Current 10 A Gain Calibration](#)
11. [DC Current 10 A Gain Calibration](#)
12. [Capacitance Offset Calibration \(Optional\)](#)
13. [Finishing Calibration](#)

First Procedure 

ADC and Zero Calibration

Each time you perform a zero calibration, the instrument stores a new set of offset correction constants for every measurement function and range. The instrument sequences through all required functions and ranges automatically and stores new zero offset calibration constants. All offset corrections are determined automatically. You may not correct a single range or function without re-entering ALL zero offset correction constants automatically. This feature is intended to save calibration time and improve zero calibration consistency.

CAUTION Never turn off the instrument during Zero Calibration. This may cause ALL calibration memory to be lost.

ADC and DC Zero Calibration Procedure

This calibration procedure applies to all models (34460A/61A/65A/70A).

Be sure to allow the instrument to warm up and stabilize for 90 minutes (or 180 minutes for 34470A) before performing the calibration.

1. Follow the steps outlined below. Review **Test Considerations** before beginning this test.
2. This procedure uses a low-thermal shorting block installed on the input connectors.

NOTE For the 34461A/65A/70A, two shorting blocks are recommended; one on the front panel and one on the rear panel. A single shorting block can be used with the 34460A.

3. Select the front panel input terminals. Install a shorting block on the front panel input terminals.
4. Select the ADC calibration mode ([Utility] > Test/Admin > Calibrate > Perform Cal > Perform ADC Cal).
5. The display will show a message indicating that ADC calibration is in process. It will then display the results of the ADC calibration. A Calibration Step Succeeded message indicates success; if the display shows Calibration Step Failed, check the input value, range, function, and entered calibration value and repeat the calibration step. Press **Save Cal Values**.
6. Select the DCV measurement function. Enter a calibration value of +0.
7. Press [Utility] > Test/Admin > Calibrate > Perform Cal > Perform Cal Step.
8. The Zero Calibration lasts approximately two minutes. A Calibration Step Succeeded message indicates success; if the display shows Calibration Step Failed, check the input value, range, function, and entered calibration value and repeat the calibration step.
9. Press **Save Cal Values**.
10. Select the rear input terminals. Install a shorting block rear-panel input terminals.
11. Repeat steps 4 through 9 for the rear input terminals.
12. Store the new ADC and Zero calibration constants (see Storing the Calibration Constants).

NOTE The following gain and flatness calibration procedures can be done using either the front or rear terminals (rear terminals not available on the 34460A). On the 34461A/65A/70A, make sure the **Front/Rear** switch matches the terminals in use.

Next Procedure 

AC Voltage Low Frequency Gain and Flatness Calibration

This calibration procedure applies to all models (34460A/61A/65A/70A).

Review [Test Considerations](#) and [Flatness Calibration Considerations](#) before performing any calibration.

Configuration: AC Voltage

1. Configure the range shown in the table below.
2. Apply the input signal shown in the Input column.
3. **Enter the actual applied input voltage amplitude** (see [Entering Calibration Values](#)). A Calibration Step Succeeded message indicates success; if the display shows Calibration Step Failed, check the input value, range, function, and entered calibration value and repeat the calibration step.
4. Repeat steps 1 through 3 for each flatness calibration point shown in the table.
5. Store the new calibration constants (see [Storing the Calibration Constants](#)).

NOTE Each voltage and frequency takes approximately 2.5 seconds to complete.

Input		Instrument
Vrms	Frequency	Range
7 V	10 Hz	10 V
7 V	40 Hz	10 V

Next Procedure

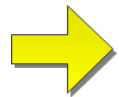

AC Voltage Gain and Flatness Calibration

This calibration procedure applies to all models (34460A/61A/65A/70A).

Review [Test Considerations](#) and [Flatness Calibration Considerations](#) before performing any calibration.

Configuration: AC Voltage

All AC calibration procedures use the 3 Hz bandwidth measurement filter.

1. Configure each function and range in the order shown in the table below.
2. Apply the input signal shown in the Input column.
3. **Enter the actual applied input voltage amplitude** (see [Entering Calibration Values](#)). A Calibration Step Succeeded message indicates success; if the display shows Calibration Step Failed, check the input value, range, function, and entered calibration value and repeat the calibration step.
4. Repeat steps 1 through 3 for each flatness calibration point shown in the table.
5. Store the new calibration constants (see [Storing the Calibration Constants](#)).

NOTE Each voltage and frequency takes approximately 2.5 seconds to complete.

Input		Instrument
Vrms	Frequency	Range
100 mV	5 kHz, 10 kHz, 20 kHz, 35 kHz, 50 kHz, 75 kHz, 100 kHz, 200 kHz, 300 kHz, 390 kHz, 400 kHz, 220 Hz, 1000 Hz	100 mV
1 v	5 kHz, 10 kHz, 20 kHz, 35 kHz, 50 kHz, 75 kHz, 100 kHz, 200 kHz, 300 kHz, 390 kHz, 400 kHz, 220 Hz, 1000 Hz	1 V
10 V	5 kHz, 10 kHz, 20 kHz, 35 kHz, 50 kHz, 75 kHz, 100 kHz, 200 kHz, 300 kHz, 390 kHz, 400 kHz, 220 Hz, 1000 Hz	10 V
50 V	5 kHz, 10 kHz, 20 kHz, 35 kHz, 50 kHz, 75 kHz, 100 kHz, 200 kHz, 300 kHz, 390 kHz, 400 kHz, 220 Hz, 1000 Hz	100 V
500 V	1000 Hz	750 V

Next Procedure 

AC Current Gain and Flatness Calibration

This calibration procedure applies to the 34460A and 34461A only.

Review [Test Considerations](#) and [Flatness Calibration Considerations](#) before performing any calibration.

Configuration: AC Current

All AC calibration procedures use the 3 Hz bandwidth measurement filter.

1. Select each range in the order shown in the table below.
2. Apply each input current and frequency shown in the Input columns.
3. Enter the actual applied input current as the Cal Value (see [Entering Calibration Values](#)). A Calibration Step Succeeded message indicates success; if the display shows Calibration Step Failed, check the input value, range, function, and entered calibration value and repeat the calibration step.
4. Repeat steps 1 through 3 for each frequency shown in the table.
5. Repeat steps 1 through 4 for each current range in the table.
6. Store the new calibration constants (see [Storing the Calibration Constants](#)).

NOTE Each current and frequency takes approximately 2.5 seconds to complete.

Input		Instrument
Current	Frequency	Range
1 A	5 kHz, 7.5 kHz, 9.7 kHz, 10 kHz, 220 Hz, 1 kHz	1 A
100 mA	5 kHz, 7.5 kHz, 9.7 kHz, 10 kHz, 220 Hz, 1 kHz	100 mA
10 mA	5 kHz, 7.5 kHz, 9.7 kHz, 10 kHz, 220 Hz, 1 kHz	10 mA
1 mA	1 kHz	1 mA
100 μ A	1 kHz	100 μ A

Next Procedure

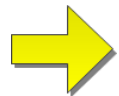

AC Zero Calibration

This calibration procedure applies to all models (34460A/61A/65A/70A).

Review [Test Considerations](#) before performing any calibration procedure.

Configuration: AC Voltage

1. Set the calibrator to 0.00 Ohm.
2. Enter a calibration value of +0. (see [Entering Calibration Values](#)). A Calibration Step Succeeded message indicates success; if the display shows Calibration Step Failed, check the input value, range, function, and entered calibration value and repeat the calibration step.
3. Store the new calibration constants (see [Storing the Calibration Constants](#)).

NOTE

This calibration takes approximately 10 seconds to complete.

Next Procedure 

Frequency Accuracy Calibration

This calibration procedure applies to all models (34460A/61A/65A/70A).

Review [Test Considerations](#) and [Gain Calibration Considerations](#) before beginning this procedure.

Configuration: Frequency, 10 V range

NOTE The frequency accuracy of the Fluke 5720A is insufficient to calibrate the DMM. Its frequency output needs to be calibrated against a more accurate reference. The Keysight 33500B Series Function/Arbitrary Waveform Generator is recommended for this calibration procedure.

1. Configure the instrument for frequency measurements at 10 V and 10 kHz, with 1 second gate time.
2. Apply a 10kHz sine wave, amplitude 20Vpp.
3. Enter the actual applied input frequency (see [Entering Calibration Values](#)). A Calibration Step Succeeded message indicates success; if the display shows Calibration Step Failed, check the input value, range, function, and entered calibration value and repeat the calibration step.
4. Store the new calibration constants (see [Storing the Calibration Constants](#)).

NOTE This calibration takes approximately 1 second to complete.

Next Procedure 

DC Voltage Gain Calibration

This calibration procedure applies to the 34460A and 34461A only.

Review [Test Considerations](#) and [Gain Calibration Considerations](#) before beginning this procedure.

Configuration: DC Voltage

1. Configure each function and range in the order shown in the table below.
2. Apply the input signal shown in the Input column.
3. **Enter the actual applied input voltage amplitude** (see [Entering Calibration Values](#)). A Calibration Step Succeeded message indicates success; if the display shows Calibration Step Failed, check the input value, range, function, and entered calibration value and repeat the calibration step.
4. Repeat steps 1 through 3 for each gain calibration point shown in the table.
5. Store the new calibration constants (see [Storing the Calibration Constants](#)).

NOTE Each range takes less than 4 seconds to complete.

Instrument Settings		
Input	Function	Range
10 V	DC Voltage	10 V
-10 V		10 V
0.1 V		100 mV
-0.1 V		100 mV
1 V		1 V
100 V		100 V
500 V		1000 V

Next Procedure 

Ohms Gain Calibration

This calibration procedure applies to all models (34460A/61A/65A/70A).

Review [Test Considerations](#) and [Gain Calibration Considerations](#) before beginning this procedure.

Configuration: 4-Wire Ohms

This procedure adjusts the gain for the 2-wire and 4-wire Ohms functions, and the offset compensated Ohms function.

1. Configure each function and range in the order shown in the table below.
2. Apply the input signal shown in the Input column.
3. Enter the actual applied input resistance (see [Entering Calibration Values](#)). A Calibration Step Succeeded message indicates success; if the display shows Calibration Step Failed, check the input value, range, function, and entered calibration value and repeat the calibration step.
4. Repeat steps 1 through 3 for each gain calibration point shown in the table.
5. Store the new calibration constants (see [Storing the Calibration Constants](#)).

NOTE Each range takes less than 4 seconds to complete.

Instrument Settings		
Input	Function	Range
100 Ω	4-wire Ohms	100 Ω
1 k Ω		1 k Ω
10 k Ω		10 k Ω
100 k Ω		100 k Ω
1 M Ω		1 M Ω
10 M Ω		10 M Ω
100 M Ω	2-wire Ohms	100 M Ω

Next Procedure 

DC Current Gain Calibration

This calibration procedure applies to the 34460A and 34461A only.

Review [Test Considerations](#) and [Gain Calibration Considerations](#) before beginning this procedure.

Configuration: DC Current

1. Configure each function and range in the order shown in the table below.
2. Apply the input signal shown in the Input column.
3. Enter the actual applied input current as the Cal Value (see [Entering Calibration Values](#)). A Calibration Step Succeeded message indicates success; if the display shows Calibration Step Failed, check the input value, range, function, and entered calibration value and repeat the calibration step.
4. Repeat steps 1 through 3 for each gain calibration point shown in the table.
5. Store the new calibration constants (see [Storing the Calibration Constants](#)).

NOTE Each range takes less than 4 seconds to complete.

Instrument Settings		
Input	Function	Range
100 μ A	DC Current	100 μ A
1 mA		1 mA
10 mA		10 mA
100 mA		100 mA
1 A		1 A

Next Procedure 

AC Current 10 A Gain Calibration

This calibration procedure applies to the 34461A, 34465A, and 34470A only (not applicable to the 34460A).

Review [Test Considerations](#) and [Flatness Calibration Considerations](#) before performing any calibration.

Configuration: AC Current

All AC calibration procedures use the 3 Hz bandwidth measurement filter.

1. Select the 10 A range.
2. Apply the 5 A input signal at 1000 Hz.
3. Enter the actual applied input current as the Cal Value (see [Entering Calibration Values](#)). A Calibration Step Succeeded message indicates success; if the display shows Calibration Step Failed, check the input value, range, function, and entered calibration value and repeat the calibration step.
4. Store the new calibration constants (see [Storing the Calibration Constants](#)).

NOTE

This calibration takes approximately 2.5 seconds to complete.

Next Procedure 

DC Current 10 A Gain Calibration

This calibration procedure applies to the 34461A, 34465A, and 34470A only (not applicable to the 34460A).

Review [Test Considerations](#) and [Flatness Calibration Considerations](#) before performing any calibration.

Configuration: DC Current

1. Configure the 10 A range and set the integration time to 100 PLC.
2. Apply the 5 A input.
3. Enter the actual applied input current as the Cal Value (see [Entering Calibration Values](#)). A Calibration Step Succeeded message indicates success; if the display shows Calibration Step Failed, check the input value, range, function, and entered calibration value and repeat the calibration step.
4. Store the new calibration constants (see [Storing the Calibration Constants](#)).

NOTE This calibration takes less than 4 seconds to complete.

Next Procedure 

Capacitance Offset Calibration (Optional)

This calibration procedure applies to all models (34460A/61A/65A/70A).

This calibration is normally not required. It compensates for residual capacitance offset which is typically less than a few pF. In normal use, any residual offset will be overridden by the null function (null also corrects for cable capacitance), and the null function is required to achieve the multimeter's capacitance specification.

Configuration: Capacitance

1. Remove all connections from the instrument's front terminals.
2. Select the front terminals.
3. Enter a calibration value of +0 (see [Entering Calibration Values](#)). A Calibration Step Succeeded message indicates success; if the display shows Calibration Step Failed, check the input value, range, function, and entered calibration value and repeat the calibration step.
4. Repeat steps 1 through 3 for the instrument's rear terminals (not applicable to the 34460A).
5. Store the new calibration constants (see [Storing the Calibration Constants](#)).

Next Procedure

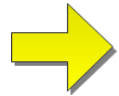

Finishing Calibration

To finish calibrating your instrument:

1. Remove all shorting blocks and connections from the instrument.
2. Reset the **calibration message**.
3. **Secure the instrument** with the calibration password.
4. Record the **new calibration count**.
5. Perform the **performance verification tests** to verify the calibration.

34465A and 34470A Calibration Procedures

The following calibration procedures apply only to the 34465A and 34470A DMMs. Perform the calibration procedures in the order listed in this document. Use the arrow links at the bottom of every page to go to the next calibration procedure.

1. [ADC and Zero Calibration](#)
2. [AC Voltage Low Frequency Gain and Flatness Calibration](#)
3. [AC Voltage Gain and Flatness Calibration](#)
4. [AC Current Gain and Flatness Calibration](#)
5. [AC Zero Calibration](#)
6. [Frequency Accuracy Calibration](#)
7. [DC Voltage Gain Calibration](#)
8. [Ohms Gain Calibration](#)
9. [DC Current Gain Calibration](#)
10. [AC Current 10 A Gain Calibration](#)
11. [DC Current 10 A Gain Calibration](#)
12. [DC High Voltage Gain Calibration](#)
13. [Capacitance Offset Calibration \(Optional\)](#)
14. [Finishing Calibration](#)

[First Procedure](#) 

ADC and Zero Calibration

Each time you perform a zero calibration, the instrument stores a new set of offset correction constants for every measurement function and range. The instrument sequences through all required functions and ranges automatically and stores new zero offset calibration constants. All offset corrections are determined automatically. You may not correct a single range or function without re-entering ALL zero offset correction constants automatically. This feature is intended to save calibration time and improve zero calibration consistency.

CAUTION Never turn off the instrument during Zero Calibration. This may cause ALL calibration memory to be lost.

ADC and DC Zero Calibration Procedure

This calibration procedure applies to all models (34460A/61A/65A/70A).

Be sure to allow the instrument to warm up and stabilize for 90 minutes (or 180 minutes for 34470A) before performing the calibration.

1. Follow the steps outlined below. Review **Test Considerations** before beginning this test.
2. This procedure uses a low-thermal shorting block installed on the input connectors.

NOTE For the 34461A/65A/70A, two shorting blocks are recommended; one on the front panel and one on the rear panel. A single shorting block can be used with the 34460A.

3. Select the front panel input terminals. Install a shorting block on the front panel input terminals.
4. Select the ADC calibration mode ([Utility] > Test/Admin > Calibrate > Perform Cal > Perform ADC Cal).
5. The display will show a message indicating that ADC calibration is in process. It will then display the results of the ADC calibration. A Calibration Step Succeeded message indicates success; if the display shows Calibration Step Failed, check the input value, range, function, and entered calibration value and repeat the calibration step. Press **Save Cal Values**.
6. Select the DCV measurement function. Enter a calibration value of +0.
7. Press [Utility] > Test/Admin > Calibrate > Perform Cal > Perform Cal Step.
8. The Zero Calibration lasts approximately two minutes. A Calibration Step Succeeded message indicates success; if the display shows Calibration Step Failed, check the input value, range, function, and entered calibration value and repeat the calibration step.
9. Press **Save Cal Values**.
10. Select the rear input terminals. Install a shorting block rear-panel input terminals.
11. Repeat steps 4 through 9 for the rear input terminals.
12. Store the new ADC and Zero calibration constants (see Storing the Calibration Constants).

NOTE The following gain and flatness calibration procedures can be done using either the front or rear terminals (rear terminals not available on the 34460A). On the 34461A/65A/70A, make sure the **Front/Rear** switch matches the terminals in use.

Next Procedure 

AC Voltage Low Frequency Gain and Flatness Calibration

This calibration procedure applies to all models (34460A/61A/65A/70A).

Review [Test Considerations](#) and [Flatness Calibration Considerations](#) before performing any calibration.

Configuration: AC Voltage

1. Configure the range shown in the table below.
2. Apply the input signal shown in the Input column.
3. **Enter the actual applied input voltage amplitude** (see [Entering Calibration Values](#)). A Calibration Step Succeeded message indicates success; if the display shows Calibration Step Failed, check the input value, range, function, and entered calibration value and repeat the calibration step.
4. Repeat steps 1 through 3 for each flatness calibration point shown in the table.
5. Store the new calibration constants (see [Storing the Calibration Constants](#)).

NOTE Each voltage and frequency takes approximately 2.5 seconds to complete.

Input		Instrument
Vrms	Frequency	Range
7 V	10 Hz	10 V
7 V	40 Hz	10 V

Next Procedure

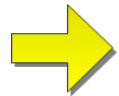

AC Voltage Gain and Flatness Calibration

This calibration procedure applies to all models (34460A/61A/65A/70A).

Review [Test Considerations](#) and [Flatness Calibration Considerations](#) before performing any calibration.

Configuration: AC Voltage

All AC calibration procedures use the 3 Hz bandwidth measurement filter.

1. Configure each function and range in the order shown in the table below.
2. Apply the input signal shown in the Input column.
3. **Enter the actual applied input voltage amplitude** (see [Entering Calibration Values](#)). A Calibration Step Succeeded message indicates success; if the display shows Calibration Step Failed, check the input value, range, function, and entered calibration value and repeat the calibration step.
4. Repeat steps 1 through 3 for each flatness calibration point shown in the table.
5. Store the new calibration constants (see [Storing the Calibration Constants](#)).

NOTE Each voltage and frequency takes approximately 2.5 seconds to complete.

Input		Instrument
Vrms	Frequency	Range
100 mV	5 kHz, 10 kHz, 20 kHz, 35 kHz, 50 kHz, 75 kHz, 100 kHz, 200 kHz, 300 kHz, 390 kHz, 400 kHz, 220 Hz, 1000 Hz	100 mV
1 v	5 kHz, 10 kHz, 20 kHz, 35 kHz, 50 kHz, 75 kHz, 100 kHz, 200 kHz, 300 kHz, 390 kHz, 400 kHz, 220 Hz, 1000 Hz	1 V
10 V	5 kHz, 10 kHz, 20 kHz, 35 kHz, 50 kHz, 75 kHz, 100 kHz, 200 kHz, 300 kHz, 390 kHz, 400 kHz, 220 Hz, 1000 Hz	10 V
50 V	5 kHz, 10 kHz, 20 kHz, 35 kHz, 50 kHz, 75 kHz, 100 kHz, 200 kHz, 300 kHz, 390 kHz, 400 kHz, 220 Hz, 1000 Hz	100 V
500 V	1000 Hz	750 V

Next Procedure 

AC Current Gain and Flatness Calibration

This calibration procedure applies to the 34465A and 34470A only.

Review [Test Considerations](#) and [Flatness Calibration Considerations](#) before performing any calibration.

Configuration: AC Current

All AC calibration procedures use the 3 Hz bandwidth measurement filter.

1. Select each range in the order shown in the table below.
2. Apply each input current and frequency shown in the Input columns.
3. Enter the actual applied input current as the Cal Value (see [Entering Calibration Values](#)). A Calibration Step Succeeded message indicates success; if the display shows Calibration Step Failed, check the input value, range, function, and entered calibration value and repeat the calibration step.
4. Repeat steps 1 through 3 for each frequency shown in the table.
5. Repeat steps 1 through 4 for each current range in the table.
6. Store the new calibration constants (see [Storing the Calibration Constants](#)).

NOTE Each current and frequency takes approximately 2.5 seconds to complete.

Input		Instrument
Current	Frequency	Range
1.5 A	5 kHz, 7.5 kHz, 9.7 kHz, 10 kHz, 220 Hz, 1 kHz	3 A
1 A	5 kHz, 7.5 kHz, 9.7 kHz, 10 kHz, 220 Hz, 1 kHz	1 A
100 mA	5 kHz, 7.5 kHz, 9.7 kHz, 10 kHz, 220 Hz, 1 kHz	100 mA
10 mA	5 kHz, 7.5 kHz, 9.7 kHz, 10 kHz, 220 Hz, 1 kHz	10 mA
1 mA	5 kHz, 7.5 kHz, 9.7 kHz, 10 kHz, 220 Hz, 1 kHz	1 mA
100 μ A	5 kHz, 7.5 kHz, 9.7 kHz, 10 kHz, 220 Hz, 1 kHz	100 μ A

Next Procedure

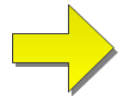

AC Zero Calibration

This calibration procedure applies to all models (34460A/61A/65A/70A).

Review **Test Considerations** before performing any calibration procedure.

Configuration: AC Voltage

1. Set the calibrator to 0.00 Ohm.
2. Enter a calibration value of +0. (see **Entering Calibration Values**). A Calibration Step Succeeded message indicates success; if the display shows Calibration Step Failed, check the input value, range, function, and entered calibration value and repeat the calibration step.
3. Store the new calibration constants (see **Storing the Calibration Constants**).

NOTE

This calibration takes approximately 10 seconds to complete.

Next Procedure 

Frequency Accuracy Calibration

This calibration procedure applies to all models (34460A/61A/65A/70A).

Review [Test Considerations](#) and [Gain Calibration Considerations](#) before beginning this procedure.

Configuration: Frequency, 10 V range

NOTE The frequency accuracy of the Fluke 5720A is insufficient to calibrate the DMM. Its frequency output needs to be calibrated against a more accurate reference. The Keysight 33500B Series Function/Arbitrary Waveform Generator is recommended for this calibration procedure.

1. Configure the instrument for frequency measurements at 10 V and 10 kHz, with 1 second gate time.
2. Apply a 10kHz sine wave, amplitude 20Vpp.
3. Enter the actual applied input frequency (see [Entering Calibration Values](#)). A Calibration Step Succeeded message indicates success; if the display shows Calibration Step Failed, check the input value, range, function, and entered calibration value and repeat the calibration step.
4. Store the new calibration constants (see [Storing the Calibration Constants](#)).

NOTE This calibration takes approximately 1 second to complete.

Next Procedure 

DC Voltage Gain Calibration

This calibration procedure applies to the 34465A and 34470A only.

Review [Test Considerations](#) and [Gain Calibration Considerations](#) before beginning this procedure.

Configuration: DC Voltage

1. Configure each function and range in the order shown in the table below.
2. Apply the input signal shown in the Input column.
3. **Enter the actual applied input voltage amplitude** (see [Entering Calibration Values](#)). A Calibration Step Succeeded message indicates success; if the display shows Calibration Step Failed, check the input value, range, function, and entered calibration value and repeat the calibration step.
4. Repeat steps 1 through 3 for each gain calibration point shown in the table.
5. Store the new calibration constants (see [Storing the Calibration Constants](#)).

NOTE Each range takes less than 4 seconds to complete.

Instrument Settings		
Input	Function	Range
10 V	DCV	10 V
-10 V		10 V
0.1 V		100 mV
-0.1 V		100 mV
1 V		1 V

NOTE The 100V and 1000V ranges are adjusted later in the [DC Voltage High Voltage Gain Calibration](#).

Next Procedure 

Ohms Gain Calibration

This calibration procedure applies to all models (34460A/61A/65A/70A).

Review [Test Considerations](#) and [Gain Calibration Considerations](#) before beginning this procedure.

Configuration: 4-Wire Ohms

This procedure adjusts the gain for the 2-wire and 4-wire Ohms functions, and the offset compensated Ohms function.

1. Configure each function and range in the order shown in the table below.
2. Apply the input signal shown in the Input column.
3. Enter the actual applied input resistance (see [Entering Calibration Values](#)). A Calibration Step Succeeded message indicates success; if the display shows Calibration Step Failed, check the input value, range, function, and entered calibration value and repeat the calibration step.
4. Repeat steps 1 through 3 for each gain calibration point shown in the table.
5. Store the new calibration constants (see [Storing the Calibration Constants](#)).

NOTE Each range takes less than 4 seconds to complete.

Instrument Settings		
Input	Function	Range
100 Ω	4-wire Ohms	100 Ω
1 k Ω		1 k Ω
10 k Ω		10 k Ω
100 k Ω		100 k Ω
1 M Ω		1 M Ω
10 M Ω		10 M Ω
100 M Ω	2-wire Ohms	100 M Ω

Next Procedure 

DC Current Gain Calibration

This calibration procedure applies to the 34465A and 34470A only.

Review [Test Considerations](#) and [Gain Calibration Considerations](#) before beginning this procedure.

Configuration: DC Current

1. Configure each function and range in the order shown in the table below.
2. Apply the input signal shown in the Input column.
3. Enter the actual applied input current as the Cal Value (see [Entering Calibration Values](#)). A Calibration Step Succeeded message indicates success; if the display shows Calibration Step Failed, check the input value, range, function, and entered calibration value and repeat the calibration step.
4. Repeat steps 1 through 3 for each gain calibration point shown in the table.
5. Store the new calibration constants (see [Storing the Calibration Constants](#)).

NOTE Each range takes less than 4 seconds to complete.

Instrument Settings		
Input	Function	Range
1 mA	DC Current	1 mA
10 mA		10 mA
100 mA		100 mA
1 A		1 A
2 A		3 A

Next Procedure 

DC High Voltage Gain Calibration

This calibration procedure applies to the 34465A and 34470A only.

Review [Test Considerations](#) and [Gain Calibration Considerations](#) before beginning this procedure.

Configuration: DC Voltage

1. Configure each function and range in the order shown in the table below.
2. Apply the input signal shown in the Input column.
3. **Enter the actual applied input voltage amplitude** (see [Entering Calibration Values](#)). A Calibration Step Succeeded message indicates success; if the display shows Calibration Step Failed, check the input value, range, function, and entered calibration value and repeat the calibration step.
4. Repeat steps 1 through 3 for each gain calibration point shown in the table.
5. Store the new calibration constants (see [Storing the Calibration Constants](#)).

NOTE Each range takes less than 4 seconds to complete.

Instrument Settings		
Input	Function	Range
100 V	DC Voltage	100 V
500 V		1000 V

Next Procedure

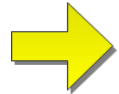

AC Current 10 A Gain Calibration

This calibration procedure applies to the 34461A, 34465A, and 34470A only (not applicable to the 34460A).

Review [Test Considerations](#) and [Flatness Calibration Considerations](#) before performing any calibration.

Configuration: AC Current

All AC calibration procedures use the 3 Hz bandwidth measurement filter.

1. Select the 10 A range.
2. Apply the 5 A input signal at 1000 Hz.
3. Enter the actual applied input current as the Cal Value (see [Entering Calibration Values](#)). A Calibration Step Succeeded message indicates success; if the display shows Calibration Step Failed, check the input value, range, function, and entered calibration value and repeat the calibration step.
4. Store the new calibration constants (see [Storing the Calibration Constants](#)).

NOTE

This calibration takes approximately 2.5 seconds to complete.

Next Procedure

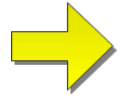

DC Current 10 A Gain Calibration

This calibration procedure applies to the 34461A, 34465A, and 34470A only (not applicable to the 34460A).

Review [Test Considerations](#) and [Flatness Calibration Considerations](#) before performing any calibration.

Configuration: DC Current

1. Configure the 10 A range and set the integration time to 100 PLC.
2. Apply the 5 A input.
3. Enter the actual applied input current as the Cal Value (see [Entering Calibration Values](#)). A Calibration Step Succeeded message indicates success; if the display shows Calibration Step Failed, check the input value, range, function, and entered calibration value and repeat the calibration step.
4. Store the new calibration constants (see [Storing the Calibration Constants](#)).

NOTE This calibration takes less than 4 seconds to complete.

Next Procedure

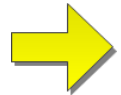

Capacitance Offset Calibration (Optional)

This calibration procedure applies to all models (34460A/61A/65A/70A).

This calibration is normally not required. It compensates for residual capacitance offset which is typically less than a few pF. In normal use, any residual offset will be overridden by the null function (null also corrects for cable capacitance), and the null function is required to achieve the multimeter's capacitance specification.

Configuration: Capacitance

1. Remove all connections from the instrument's front terminals.
2. Select the front terminals.
3. Enter a calibration value of +0 (see [Entering Calibration Values](#)). A Calibration Step Succeeded message indicates success; if the display shows Calibration Step Failed, check the input value, range, function, and entered calibration value and repeat the calibration step.
4. Repeat steps 1 through 3 for the instrument's rear terminals (not applicable to the 34460A).
5. Store the new calibration constants (see [Storing the Calibration Constants](#)).

Next Procedure

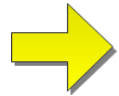

Finishing Calibration

To finish calibrating your instrument:

1. Remove all shorting blocks and connections from the instrument.
2. Reset the **calibration message**.
3. **Secure the instrument** with the calibration password.
4. Record the **new calibration count**.
5. Perform the **performance verification tests** to verify the calibration.

Index

*

*CAL? 266
*CLS 266
*ESE 267
*ESR? 268
*IDN? 269
*LRN? 271
*OPC 271
*OPC? 272
*OPT? 272
*PSC 273
*PSC? 273
*RST 274
*SAV 273
*SRE 274
*STB? 275
*TRG 275
*TST? 276
*WAI 276

2

2-wire measurements 346-347, 352
2-wire Resistance 250, 313, 353-355
2-Wire Resistance 66
2-wire RTD 251
2-Wire vs. 4-Wire Measurements 172

3

34460A and 34461A adjustments 542
34461A adjustments 542
34465A and 34470A Adjustments 557
34470A adjustments 557
34470A and 34465A adjustments 557

4

4-wire Resistance 250, 313, 353-355
4-Wire Resistance 66
4-wire RTD 251, 361

A

ABORt 201
About Digitizing Mode 178
AC 247, 252, 284, 289, 320-327, 374-380
AC Current 64, 313, 325-326
AC current flatness 547, 562
AC Current Measurement Errors (Burden Voltage) 190
AC current verification 518, 523
AC Voltage 60, 252, 313, 378-379
AC voltage verification 518
AC Zero Calibration 548, 563
ACALibration 394-395
ACI 64
acquiring readings 95
ACV 60
ADC 237, 543, 558
ADDRess 408

ADJust 369
adjustments 525, 531-532, 543, 556,
558, 572
Admin 147
Aliasing 177
ALL 208, 218, 230, 238, 293, 424
APERture 327, 337, 346-347, 359, 380
APERture Enabled 381
APERture ENABLEd 328, 359
ASCII String Parameters 198
AUTO 197, 220, 226, 245, 250, 252, 254,
282, 299-300, 316, 323, 325-326,
332, 339, 343, 351, 354, 357, 362,
372, 377, 379, 382, 386, 431
Autocal command 266
Autocalibration 139
Automatic input impedance 382
automatic trigger delays 458
Autorange 245, 250, 252, 254, 282, 354,
379
Autozero 310, 332, 357, 386
Autozero On/Off 173
AVERage 212, 230, 232
Average, moving 234-235

B

BANDwidth 320, 374
Bar Meter 121
battery 494
BEEPer 395-396
BMP 263

Boolean Parameters 198
BORDER 261
Burden Voltage 190
BUS 198, 434

C

CALCulate 212, 214-216, 218-228, 230,
232, 234-235
AVERage Subsystem 229
histogram 218-221
HISTogram Subsystem 217
LIMit Subsystem 213
SCALe Subsystem 222
scaling 228
smoothing 234-235
TCHart
STATe 236
CALCulate Subsystem Introduction 210
calibration 508, 512, 517-518, 523, 525-
526, 530-535, 543, 547, 556, 558,
562, 572
CALibration 237-242, 447
calibration adjustments 532
calibration count 535
Calibration Errors 462
CALibration Subsystem 237
Capacitance 76
CAPacitance 245, 282, 314-318
Capacitance Measurement Con-
siderations 176

Capacitance Offset Calibration (Optional) 555, 571

Capacitance Theory 175

Capacitance Verification (Optional Verification Test) 524

Carrying Handle 40

CATalog 293, 423

CD-ROM 194

CDIRectory 294

celsius 368, 370

Characteristics 327, 346, 359, 380

Chart 124

CHECK 367

CLEAr 219

CLEAR 212, 214, 232, 260

CLICK 396

CLS 197, 266

CODE 239

Command Errors 462

Command Quick Reference 436

Command Separators 196

Command Summary 243, 261, 280, 306

Commands by Subsystem 199

Common Mode Errors 191

COMMunicate 407-416, 418

CONDition 390-391

CONFigure 245-252, 254

Configure I/O 144

CONFigure Subsystem 243

CONFigure? 245

configuring remote interface 27, 32

contacting Keysight 35

Continuity 77

CONTInuity 246, 283, 313

CONTInuous 333

Continuous Mode 47

CONTrol 409

COPY 294

count 535

COUNt 219, 230, 238, 306-307, 402, 425, 429

CSEPARATOR 303

CURREnt 247, 284, 313, 320-333

current fuse replacement 496

current verification 518

Current, DC 62

D

DATA 215, 218, 256-258, 261, 263, 303, 305

Data Log and Digitize Mode Default Settings 48

Data Log Mode 47, 81, 181

Data Log Mode Features 181

Data Logging 81

Data Logging Local/Remote Interaction 180, 186

Data Logging, Trend Chart 127

DATA Subsystem 256

DATA2 334

DATE 397

DATE? 239, 394
DB 222
dB Scaling 103
DBM 223
dBm Scaling 103
DC 247, 254, 284, 289-290, 293, 321-332, 375-377, 380-386
DC Current 62, 171, 313, 330, 332
DC Current Gain Calibration 552, 567
DC current verification 523
DC measurements 457
DC Voltage 57, 313, 382-384, 386
DC voltage measurements 57
DCI 62
DCV measurements 57
DCV tutorial 57
DEFault 196
Default Settings 243, 280, 476
DElay 308, 430-431
Delay, trigger 97
delays, trigger 458
DElete 295, 424
DESCription 424
DESired 278
Device-Specific Errors 462
Device Clear 199, 409
DHCP 409
Digitize Mode 47, 86
Digitizing 86

Digitizing Local/Remote Interaction 180, 186
Digitizing Measurements 177
Digitizing Mode 178
Digitizing, Trend Chart 127
Diode 78
DIODe 248, 285, 313
disassembly 490
Discrete Parameters 198
DISPlay 198, 259-260
Display Bar Meter 121
Display Histogram 133
Display Introduction 114
Display Number 116
DISPlay Subsystem Introduction 259
Display Trend Chart (Continuous Mode) 124
Distributor installed options 26
dmm 367-368, 370
DNS 410
DOMain 410
DOWNload 303
Drivers 194

E

ENABle 277, 390, 392, 407, 419
End-Or-Identify 197
ERRor 398, 425
Error Messages 462
Error Queue 462

Errors in High Resistance Measurements 166
ESE 197, 267
ESR? 268
Estimating High-Frequency (Out-of-Band) Error 169
EVENT 257-258, 391-392
Event Status Enable 273
Execute SAMPLe 310
Execution Error 462
Ext Trig BNC 434
EXTernal 198, 434

F

Factory installed options 26
Factory Reset 261, 274, 308-309, 311, 314-315, 327, 346, 359, 380, 397, 404, 476
Factory Settings 476
FAST 234, 333
features 46
FETCh? 202
Files, Manage 142
finishing adjustments 556, 572
firmware update 34
flatness 547, 562
flatness adjustments 531
flatness calibration 547, 562
FNAME 303
FORMat 261, 263, 303-304
FORMat Subsystem 261

Frequency 79
FREQuency 249, 286, 313, 337-344
Frequency and Period Measurement Errors Frequency and Period Measurement Errors Frequency and Period Measurement Errors 171
frequency gain verification 517
FRESistance 250, 287, 313, 346-356
FRONt 207
Front and rear terminals 207
front panel 24
Front panel keys 50
Front panel menu reference 50
FRTD 251, 288, 365, 367

FTHermistor 371
FUNCTion 223, 313
functions 46
fuse replacement 496

G

GAIN 224-225
gain adjustment 530-531
gain verification 512, 517
GATeway 411
GPIB 194, 408
GPIB option 499
Ground Loops, Noise 164

H

Handle 40
HCOPy 263

HCOPy Subsystem 263
Help 41
HELP 399
Help system 41
HI-Z 382
High-Voltage Self-Heating Errors 190
High-Frequency (Out-of-Band)
Error 169
High-Frequency Signal Content and True
RMS Accuracy 168
High-Speed AC Measurements 173
High-Speed DC and Resistance Meas-
urements 174
High Resistance Measurement Errors 166
Histogram 133
HISTogram 218-221
HNAME 278
hold readings 100
HOST 419
HOSTname 412
How Sample Rate/Interval is
Determined 193
HP34401A 400

I

I/O Configuration 144
LAN 424, 426
IDENTify 277, 400
IDN? 269
IEEE 488.2 Commands 197, 271
IEEE 488.2 Common Commands 264

IMMediate 198, 203, 212, 214, 232, 395,
403, 434
IMPedance 382
INFormation 304
INITiate 203
Input impedance 382
Input terminal measurement limits 18
INSTall 426
Instrument Errors 462
Instrument Preset 261, 308, 311, 397,
404, 476
integration table 457
integration time 457
INTernal 431, 434
internal DMM 367-368
internal fuse replacement 496
Interval and Sample Rate 193
Introduction to instrument 23
Introduction to the SCPI Language 195
IPADdress 413

K

Keysight 35
Keysight IO Libraries Suite 194

L

LABel 401
LAN 409-416, 418
configuring 278
LAN configuration 27

LAN Configuration 32
LAST 256
Leakage Current Errors 192
Learn String 271
LEVel 431
Level Triggering 178
Level Triggering Details 91, 187
LFRequency 401
LICense 423-426
LIMit 214-216, 444
Limits 110
Limits, measurement 18
Line Noise Voltages, Rejecting 163
LOAD 298-299
Loading Errors (AC volts) 189
Loading Errors (DC Voltage) 162
LOCal 401
Local key 259
Local/Remote Interaction 180, 186
LOCK 421-422
Low-Power 353, 365-366
Low-Level Measurement Errors 191
LOWer 215, 220, 340
LPOWer 353, 366
LRN 271
LXI 277-279
LXI Subsystem 277

M

MAC 413
Magnetic Loops, Noise 163
Making High-Speed AC
Measurements 173
Making High-Speed DC and Resistance
Measurements 174
Manage Files 142
Master Summary 275
Math Functions 227
Math Introduction 101
Math Limits 110
Math Null 102
Math Scaling 105
Math Smoothing 108
Math Statistics 109
MAXimum 196, 230
Maximum limits 18
MDIRectory 294
MDNS 277-278
MEASure 282-290, 436
MEASure Subsystem 280
Measurement Considerations 160
Measurement Considerations, Capa-
citanace 176
Measurement limits 18
Measurement Tutorial 159
Measurements 56
Measurements Below Full Scale 190
MEDium 234

Menu reference 50
Minimizing Power Dissipation Effects 166
MINimum 196, 230
MMEMory 293-295, 298-300, 303-305,
397, 404
MMEMory Subsystem - Data Transfer
Commands 301
MMEMory Subsystem - General Purpose
File Management 291
MMEMory Subsystem - STATe and
PREFErence Files 296
MODE 333
Models and options 26
MOVE 295
Mx-B Scaling 227

N

NAME 421
NEGative 204, 433
NEXT 398
Noise Caused by Ground Loops 164
Noise Caused by Magnetic Loops 163
Noise Rejection 163
Nonvolatile Memory 382, 419
Notices, safety 13
NPLC 327, 329, 346, 348, 359-360, 380,
383
Null 102
NULL 314-316, 321-323, 338-339, 349-
351, 361-362, 375-377
NULL Reading 173

Number 307
pretrigger 307
Numeric Parameters 197
Nyquist Rate 177
O
OCOMpensated 352, 364
OFF
autoranging 316
ONCE 325-326, 332, 354, 357, 372, 379,
386
OPC 197, 271-272
OPC? 272
OPERation 390-391
OPT? 272
Options and models 26
Out-of-Band Error 169
OUTPut 204
OWNer 421

P

Parameter Settings 196
Parts, Replaceable 489
password 533
Performance Verification Tests 505
Period 79
PERiod 286, 313, 337-344
Period and Frequency Measurement
Errors 171
PLC 327, 346, 359, 380, 383, 454

PNG 263
POINts 219, 256-257
POSitive 204, 433
power-on self-test 488
Power-On Status Clear 273
Power-on/reset 476
Power Dissipation Effects,
 Minimizing 166
power supplies 481
Power supply voltages 484
PREferences 298
Preferences Store and Recall 140
PRESet 308, 391, 397, 402, 404, 476
PRETrigger 307
Probe Hold 100
Probe Type Choice, Temperature 172
PROMpt 415
PSC 273, 390, 392
PTPeak 230

Q

Query Errors 462
Querying 196
QUESTionable 391-392
Questionable Data Register 273
Quick Reference 436

R

R? 205
rack 44

rack mount 44
range 454
RANGe 220, 316-317, 324-325, 340,
 342-343, 353-354, 378-379
range table 454
RATio 254, 290, 313, 384
RCL 273
RDG_STORE 305
RDIRECTory 294
READ? 206
READING 303-304
reading acquisition 95
readings 95
REAR 207
rear panel 25
RECall 299-300
REFerence 222-223, 226, 365
Rejecting Power-Line Noise
 Voltages 163
RELease 421
remote interface 27
REMOve 258
Removing Test Lead Resistance
 Errors 165
repair 479, 529, 536, 545-546, 549-551,
 553-554, 560-561, 564-566, 568-
 570
Replaceable Parts 489
replacing fuses 496
REQuest 422
RESet 279

Reset state 476
Resistance 66
RESistance 250, 287, 313, 348-357, 365
Resistance Measurement
 Considerations 165
resolution 454
RESolution 330, 355, 359, 384
resolution table 454, 457
RESolved 278
RESPonse 234
REStart 279
Return Format 310
Returns 317
 autoranging 316
 pretrigger 307
RJUNction 369
RLIMit 304
ROUTe 207
Row limit 304
RST 197, 274, 397, 404
RTD 251, 288, 361, 365, 367, 371

S

Safety information 11
Safety notices 13
Safety symbols 13
SAMPlE 306-308, 310
Sample Rate and Interval 193
SAMPlE Subsystem Introduction 306
SAV 273

SCALe 222-228
Scaling 105, 228, 445
 function 313, 321-323, 338-339, 349-351, 361
 reference 254, 290
 units 228
Scaling, dB/dBM 103
SCPI Command Terminators 197
SCPI Parameter Types 197
SDEViation 230
SDUMp 263
SECondary 327, 331, 344, 363, 380, 384-385
Secondary Measurements 93
SECondary, CAPacitance 318, 356
SECure 239-240
security 533
SECurity 402-403
security code override 501, 537
SElect 300
Self-Heating Errors 190
self-test 488
Self-test 276
Self-Test Errors 462
SENSE 313-318, 320-333, 337-344, 346-357, 359-367, 369, 371-372, 374-386
 {FREQuency|PERiod} Subsystem 336
 {RESistance|RESistance}
 Subsystem 345
 CURRent Subsystem 319

DATA2 Subsystem 334
 DATA2? 334
 TEMPerature Subsystem 358
 VOLTage Subsystem 373
 SENSE Subsystem Introduction 313
 Serial Poll 275
 service 479, 529, 536, 545-546, 549-551,
 553-554, 560-561, 564-566, 568-
 570
 Service Request 409
 enable 391
 Settling Time Effects 189
 Setup, System 149
 SLOPe 204, 433
 SLOW 234
 SMASk 414
 Smoothing 108
 SMOothing 234-235
 SNAME 278
 SOURce 308, 431, 434
 SRE 274
 Standard Event Register 273
 Standard Operation Register 273
 STATe 216, 221, 227-228, 232, 235, 240,
 277, 299-300, 314-316, 321, 338,
 349, 361, 375, 396
 State Store and Recall 140
 Statistical functions
 maximum value 196
 minimum value 196
 Statistics 109
 STATus 390-392
 Status Byte Register 273
 STATus Subsystem 387
 STB? 275
 STORe 240, 298-299, 305
 STRing 241
 support 35
 SWITCh 333
 Symbols, safety 13
 Syntax Conventions 195
 SYSTem 395-405, 407-416, 418-419,
 421-426
 LICense Subsystem 423
 LOCK Subsystem 420
 System Setup 149
 SYSTem Subsystem - General Purpose
 Commands 393
 SYSTem Subsystem - IO
 Configuration 406

T

taking readings 95
 TELNet 415-416
 TEMP? 241, 394
 TEMPerature 198, 209, 251, 288, 359,
 359-365, 367, 369, 371-372, 403
 Temperature (34460 and 34461A) 69
 Temperature (34465A and 34470A) 71
 Temperature Measurements 172
 Temperature Probe Type Choice 172

TERMinals 207, 326
TEST 208
Test Lead Resistance Errors,
 Removing 165
Test/Admin 147
TEXT 198, 259-260
The Sampling Rate 177
Thermal EMF Errors 162
THERmistor 366, 371
thermocouple 367-368, 370-371
thermocouple type 371
THReshold 257-258
TIME 404
TIME? 241, 395
TIMeout 341
TIMer 310
 set 310
TRANsducer 365, 367, 371
TRANsform 218-221
Trend Chart (Continuous Mode) 124
Trend Chart (Digitizing and Data Logging
 Modes) 127
TRG 275
TRIG 431
Trigger 306, 308, 431
TRIGger 204, 429-431, 433-434
Trigger delay 97
Trigger Delay 430
trigger delays 458
TRIGger Subsystem 428

triggering 95
Troubleshooting 484
True RMS AC Measurements 167
True RMS Accuracy and High-Frequency
 Signal Content 168
TST? 276
TYPE 367

U

UNIT 197, 209, 227-228
units 368, 370
Unnecessary Signal Errors 192
UPDate 416
updating firmware 34
UPLoad 305
UPPer 215, 220, 317, 324, 342, 353, 378
UPTime 404
USB flash drive 419
User installed options 26
Utility Menu 138
Utility, Store and Recall 140

V

VALid 300
VALue 242, 315-316, 322-323, 339, 350-
 351, 361-362, 376-377
verification 512, 517-518, 523
Verification Tests 505
VERSion 404
VIEW 260

VM Comp Output (BNC) 461

VOLTage 252, 254, 289-290, 342-343,
374-386

voltage verification 518

Voltmeter Complete 461

W

WAI 276

Wait-for-trigger 275, 308-309, 311

Web Interface 152, 194

Web UI 152

WINS 418

WMESsage 405, 416

Z

ZERO 332, 357, 372, 386

zero offset verification 508

© Keysight Technologies, Inc. 2013 - 2023

All rights reserved.

Part Number: 34460-90901

Printed in Malaysia: Edition 10, September 2023



Multimètres numériques

Série True *volt*

Ce manuel contient des informations pour l'utilisation, la programmation et la maintenance des multimètres numériques (DMM) Keysight de la série True *volt*.

Avertissement : Ce document contient des références à Agilent Technologies. L'ancienne activité de test et de mesure d'Agilent est devenue Keysight Technologies. Pour de plus amples informations, rendez-vous sur www.keysight.com.



Informations de sécurité et réglementaires	11
Avertissements	11
Informations sur le manuel	11
Version du logiciel	11
Garantie	11
Licences technologiques	12
Légende de limitation des droits	12
Consignes de sécurité	13
Symboles de sécurité	13
Informations sur la sécurité	14
Généralités	14
Conformité et réglementation des produits	16
Limites de mesure	17
Limites de mesure des bornes d'entrée	18
Limites de mesure des bornes de mesure	19
Appareil de mesure de classe II conforme à la norme CEI	19
Jeu de cordons de test Keysight 34139A	20
Caractéristiques assignées des cordons de test	20
Utilisation	20
Maintenance	20
Déclaration de conformité	20
Bienvenue	21
Informations générales	21
Informations utilisateur	21
Référence de programmation SCPI	22
Entretien et réparation	22
Vérification du fonctionnement	22
Procédures d'étalonnage	22
Présentation de l'instrument	23
Présentation générale de l'instrument	23
Affichage – Affichez, enregistrez et documentez aisément vos résultats de mesure	23
Mesures – Performances de mesure Truevolt de Keysight alliées à un accès de pointe aux E/S	23
Langage de programmation	23
Bref aperçu du panneau avant	24
Touches du panneau avant	24
Bref aperçu du panneau arrière	25
Modèles et options	26
Options installées en usine	26
Options installées par le distributeur ou le client final	26
Configuration de l'interface de commande à distance	28
Logiciel de connectivité	28
Configuration GPIB	28
Configuration LAN	29
Interface Web	32
Procédure de configuration du réseau local	33
En savoir plus sur les adresses IP et leur notation	34
Mise à jour du microprogramme	35
Contactez Keysight Technologies	36
Prise en main	37
Préparation de l'instrument avant utilisation	37
Réglage du sélecteur de tension d'alimentation secteur et installation des fusibles	38

Branchement du cordon d'alimentation et des câbles d'E/S	40
Réglage de la poignée de transport	41
Utilisation du système d'aide intégrée	42
Affichage de l'aide sur une touche du panneau avant	42
Affichage de la liste des rubriques d'aide et utilisation des démonstrations interactives	43
Affichage de la liste des erreurs récentes de l'instrument	44
Affichage de l'aide sur les messages	44
Montage de l'instrument dans une baie	45
Dépose de la poignée et des plots	45
Montage d'un instrument unique dans une baie	45
Retrait des vis latérales et des rondelles du panneau avant	46
Montage d'instruments côte-à-côte dans une baie	46
Étagère coulissante	46
Caractéristiques et fonctions	47
Modes Continu, Enregistrement de données et Numérisation	48
Mode Continu	48
Mode Enregistrement de données	48
Mode Numérisation	48
Paramètres par défaut des modes Enregistrement de données et Numérisation	49
Paramètres d'enregistrement de données par défaut supplémentaires	49
Paramètres de numérisation par défaut supplémentaires	50
Aide-mémoire des menus du panneau avant	51
Touche [Acquire] (Acquisition)	57
Touche [Math] (Opération mathématique)	57
Touche [Display] (Affichage)	57
Touche [Utility] (Utilitaire)	58
Mesures	59
Tension continue	60
Tension alternative	63
Courant continu	65
Courant alternatif	67
Résistance	69
Température (34460A et 34461A)	72
Température (modèles 34465A et 34470A)	74
Capacité	79
Continuité	80
Diode	81
Fréquence et période	82
Enregistrement de données	84
Numérisation	90
Déclenchement par niveau	96
Mesures secondaires	98
Déclenchement et lectures	100
Modèle de déclenchement de l'instrument	100
Retard de déclenchement et échantillons multiples	102
Stockage et effacement de mesures	103
Probe Hold (Maintien de la sonde)	106
Math (Opération mathématique) - Introduction	107
Math (Opération mathématique) - Null (Valeur de référence)	108
Math (Opération mathématique) - dB/dBm Scaling (Réglage d'échelle dB/dBm)	109
Math (Opération mathématique) - Scaling (Réglage d'échelle)	111
Math (Opération mathématique) - Smoothing (Lissage)	114

Math (Opération mathématique) - Statistics (Statistiques)	115
Math (Opération mathématique) - Limits (Limites)	116
Display (Affichage) - Introduction	120
Sélection de l'affichage	120
Nombre	122
Barre de mesure	127
Diagramme de tendance (Mode de mesure continue)	130
Diagramme de tendance (Modes Numérisation et Enregistrement de données)	134
Histogramme	141
Menu Utility (Utilitaire) - Introduction	146
Utility (Utilitaire) - Autocalibration (Étalonnage automatique) (34465A/70A uniquement)	147
Utility (Utilitaire) - Sauvegarder et rappeler des fichiers de configuration et de préférences	148
Menu Utility (Utilitaire) - Manage Files (Gérer les fichiers)	150
Menu Utility (Utilitaire) - I/O Configuration (Configuration des E/S)	152
Menu Utility (Utilitaire) - Test/Admin (Test/Administration)	156
Menu Utility (Utilitaire) - System Setup (Configuration système)	159
Interface Web	162
Page d'accueil	162
Page de surveillance et de contrôle de l'instrument	163
Page de configuration	167
Aide	168
Didacticiel de mesure	169
Considérations relatives aux mesures	170
Métrologie	171
Considérations relatives aux mesures en courant continu	172
Erreurs de FEM thermique	172
Erreurs dues à la charge (tension continue)	172
Réjection du bruit	173
Réjection des tensions de bruit engendrées par l'alimentation secteur	173
Réjection de mode commun	173
Bruit provoqué par les boucles magnétiques	174
Bruit provoqué par les boucles de masse	174
Considérations relatives aux mesures de résistance	175
Suppression des erreurs de résistance des cordons de test	175
Minimisation des effets de la dissipation de puissance	176
Erreurs de mesure de résistance élevée	177
Mesures de valeurs efficaces vraies en courant alternatif	178
Précision de la valeur efficace vraie et contenu en signaux à haute fréquence	179
Estimation de l'erreur en haute fréquence (hors bande)	180
Autres fonctions de mesure principales	182
Erreurs de mesure de fréquence et de période	182
Courant continu	182
Mesures de température	183
Lecture NULL (Valeur de référence)	184
Activation/désactivation du réglage automatique du zéro	184
Réalisation de mesures en courant alternatif haut débit	184
Réalisation de mesures en courant continu et de résistance haut débit	185
Capacité	186
Considérations relatives aux mesures de capacité	187
Numérisation de mesures	188
La fréquence d'échantillonnage	188
Déclenchement par niveau	189

À propos du mode Numérisation	189
Interaction locale/à distance avec l'enregistrement de données et la numérisation	192
Mode Enregistrement de données	193
Fonctions du mode Enregistrement de données	194
Enregistrement de données et affichage du diagramme de tendance	198
Interaction locale/à distance avec l'enregistrement de données et la numérisation	199
Déclenchement par niveau	200
À propos du déclenchement par niveau	200
Autres sources d'erreur de mesure	202
Effets du temps de stabilisation	202
Erreurs dues à la charge en courant alternatif (tensions alternatives)	202
Mesures en-dessous de la pleine échelle	203
Erreurs dues aux effets d'auto-échauffement haute tension	203
Erreurs de mesure en courant alternatif (chute de tension)	203
Erreurs de mesure de faible niveau	204
Erreurs de mode commun	204
Erreurs de courant de fuite	205
Erreurs de signaux inutiles	205
Mode de détermination de la fréquence/l'intervalle d'échantillonnage	206
Référence de programmation SCPI	207
Informations connexes	207
Bibliothèques d'E/S et pilotes de l'instrument	207
Documentation de Keysight série Truevolt	207
Interface Web	207
Présentation du langage SCPI	208
Conventions syntaxiques	208
Séparateurs de commandes	209
Utilisation des paramètres MIN, MAX et DEF	209
Requêtes sur les paramètres	210
Caractères de fin de commande SCPI	210
Commandes courantes IEEE-488.2	210
Types de paramètres SCPI	211
Utilisation de Device Clear	212
Commandes par sous-système	212
ABORt	215
FETCh?	216
INITiate[:IMMEDIATE]	217
OUTPut:TRIGger:SLOPe {POSitive NEGative}OUTPut:TRIGger:SLOPe?	218
R? [<lectures_max>]	219
READ?	220
ROUTE:TERMinals?	221
TEST:ALL?	222
UNIT:TEMPerature {C F K}UNIT:TEMPerature?	223
Sous-système CALCulate - Présentation	224
Sous-système CALibration	251
Sous-système CONFigure	257
Sous-système DATA	272
Sous-système DISPlay	275
Sous-système FORMat	277
Sous-système HCOpy	279
Commandes courantes IEEE 488.2	280
Sous-système LXI	293

Sous-système MEASure	296
Sous-système MMEMory - Gestion de fichiers de base	307
Sous-système MMEMory - Fichiers STATE et PREFERence	313
Sous-système MMEMory - Commandes de transfert de données	320
Sous-système SAMPLe	325
Sous-système SENSE - Présentation	333
Sous-système STATus	408
Sous-système SYSTem - Commandes de base	414
Sous-système SYSTem - Configuration des E/S	427
Commandes LOCK du sous-système SYSTem	442
Commandes LICense du sous-système SYSTem	445
Sous-système TRIGger	450
Aide-mémoire des commandes	457
Commandes de configuration	457
Commandes de mesure	457
Commandes de configuration des mesures	457
Commandes d'échantillonnage	464
Commandes de déclenchement	464
Commandes (mathématiques) de calcul	465
Commandes de mémoire de mesures	467
Commandes d'étalonnage	468
Commandes de stockage des états et des préférences	468
Commandes de gestion de fichiers de base	469
Commandes de transfert de données	470
Commandes IEEE-488	470
Sous-système Format	471
Commandes système	471
Commandes de verrouillage des interfaces	472
Commandes de gestion des licences	473
Commandes de configuration des interfaces	473
Commandes du système d'état	474
Plage, résolution et temps d'intégration (affichés dans Ouverture et NPLC)	475
Résolution et temps d'intégration pour les mesures en courant continu	478
Retards de déclenchement automatiques	479
Retards par défaut de la tension continue	479
Retards par défaut du courant continu	479
Retards par défaut de la résistance (2 fils)	480
Retards par défaut de la résistance (4 fils)	480
Retards par défaut de la tension alternative	480
Retards par défaut du courant alternatif	481
Fréquence et période	481
Sortie VM Comp (Mesure terminée) (BNC)	482
Messages d'erreur SCPI	483
Erreurs de commande (-100...)	485
Erreurs d'exécution (-200...)	487
Erreurs propres au dispositif (-300...)	490
Erreurs de requête (-400...)	490
Erreurs réseau (+100...)	490
Erreurs de l'instrument (+200...)	491
Erreurs diverses (+300... et +500..)	491
Erreurs de licence et d'autotest (+600...)	492
Erreurs d'étalonnage (+700...)	494
Erreurs diverses (+800...)	496

État à la mise sous tension/réinitialisation	497
Réglages usine par défaut	497
Entretien et réparation	501
Types d'interventions et de contrats de maintenance possibles	501
Trouver un service de réparation (international)	501
Remballage pour l'expédition	502
Nettoyage	502
Précautions contre les décharges électrostatiques (ESD)	503
Blocs d'alimentation	504
Dépannage	507
Procédure de dépannage	508
Procédures d'autotest	511
Autotest à la mise sous tension	511
Autotest complet	511
Pièces remplaçables par l'utilisateur	512
Démontage	513
Outils nécessaires	513
Procédure générale de démontage	514
Remplacement de la batterie	517
Outils nécessaires	517
Procédure	518
Remplacement des fusibles d'entrée de courant 3 A et 10 A	519
Outils nécessaires	519
Test des fusibles	520
Procédure de remplacement des fusibles internes	521
Installation de l'interface GPIB en option	522
Outils nécessaires	522
Procédure d'installation	522
Conservez le couvercle GPIB	522
Remplacement du code de sécurité	524
Quelle procédure dois-je suivre ?	524
Procédure A : pour les révisions de microprogramme se terminant par 02 ou supérieur	525
Procédure B : pour les révisions de microprogramme se terminant par 01	527
Vérification du fonctionnement	528
Contrôle rapide du fonctionnement	529
Tests de vérification du fonctionnement	530
Équipement de test recommandé	530
Vérification du décalage du zéro	531
Vérification du gain en tension et courant continus	535
Vérification de la précision de fréquence	542
Vérification de la tension et du courant alternatifs	543
Vérification de courant élevé	549
Vérification des mesures de capacité (test de vérification en option)	550
Procédure de réglage de l'étalonnage	551
Procédures d'étalonnage	552
Connexions d'entrée	554
Considérations relatives aux tests	555
Équipement de test recommandé	555
Procédure de réglage de l'étalonnage	557
Présentation du réglage de l'étalonnage de gain	558
Présentation du réglage de l'étalonnage de gain et de la planéité	559

Saisie des valeurs d'étalonnage et enregistrement des constantes d'étalonnage	560
Sécurité de l'étalonnage	561
Message d'étalonnage	562
Nombre de points d'étalonnage	563
Interruption d'un étalonnage en cours	564
Remplacement du code de sécurité	565
Procédures d'étalonnage des multimètres 34460A et 34461A	570
Étalonnage du CAN et du zéro	571
Étalonnage du gain et de la planéité à basse fréquence en tension alternative	573
Étalonnage du gain et de la planéité en tension alternative	574
Étalonnage du gain et de la planéité en courant alternatif	575
Étalonnage du zéro en CA	576
Étalonnage de la précision de fréquence	577
Étalonnage du gain en tension continue	578
Étalonnage du gain de résistance	579
Étalonnage du gain en courant continu	580
Étalonnage du gain 10 A en courant alternatif	581
Étalonnage du gain 10 A en courant continu	582
Étalonnage du décalage de capacité (en option)	583
Finalisation de l'étalonnage	584
Procédures d'étalonnage des multimètres 34465A et 34470A	585
Étalonnage du CAN et du zéro	586
Étalonnage du gain et de la planéité à basse fréquence en tension alternative	588
Étalonnage du gain et de la planéité en tension alternative	589
Étalonnage du gain et de la planéité en courant alternatif	590
Étalonnage du zéro en CA	591
Étalonnage de la précision de fréquence	592
Étalonnage du gain en tension continue	593
Étalonnage du gain de résistance	594
Étalonnage du gain en courant continu	595
Étalonnage du gain en tension continue	596
Étalonnage du gain 10 A en courant alternatif	597
Étalonnage du gain 10 A en courant continu	598
Étalonnage du décalage de capacité (en option)	599
Finalisation de l'étalonnage	600
Index	601

Informations de sécurité et réglementaires

Avertissements

© Keysight Technologies 2013 – 2023

Conformément aux lois internationales relatives à la propriété intellectuelle, toute reproduction, tout enregistrement électronique et toute traduction de ce manuel, totalement ou en partie, sous quelque forme et par quelque moyen que ce soit, sont interdits sauf accord écrit préalable de la société Keysight Technologies, Inc.

Informations sur le manuel

Référence : 34460-90912, Édition 10, septembre 2023

Keysight Technologies, Inc.
900 S. Taft Ave.
Loveland, CO 80537 États-Unis

Version du logiciel

Pour obtenir la dernière version du microprogramme, accédez à la page du produit à l'adresse www.keysight.com/find/truevolt.

La dernière documentation du produit est disponible à l'adresse www.keysight.com/find/truevolt-doc. Pour consulter la documentation des appareils mobiles, rendez-vous sur www.keysight.com/find/truevolt-mobilehelp.

Une partie du logiciel de ce produit est soumise à licence selon les termes de General Public License Version 2 (« GPLv2 »). Le texte de la licence et le code source se trouvent à l'adresse www.keysight.com/find/GPLV2.

Ce produit utilise Microsoft Windows CE. Keysight recommande instamment que tous les ordinateurs sous Windows connectés aux instruments sous Windows CE utilisent un antivirus courant. Pour plus d'informations, rendez-vous sur www.keysight.com/find/truevolt.

Garantie

Les informations contenues dans ce document sont fournies « en l'état » et peuvent faire l'objet de modifications sans préavis dans les éditions ultérieures. Par ailleurs, dans les limites de la législation en vigueur, Keysight exclut en outre toute garantie, expresse ou implicite, concernant ce manuel et les informations qu'il contient, y compris, mais non exclusivement, les garanties de qualité marchande et d'adéquation à un usage particulier. Keysight ne saurait en aucun cas être tenu responsable des erreurs ou des dommages incidents ou indirects, liés à la fourniture, à l'utilisation ou à l'exactitude de ce document ou aux performances de tout produit Keysight auquel il se rapporte. Si Keysight a passé un contrat écrit avec l'utilisateur et que certains termes de ce contrat semblent contradictoires avec ceux de ce document, les termes et conditions de la garantie prévalent.

Licences technologiques

Le matériel et le logiciel décrits dans ce document sont protégés par un accord de licence ; leur utilisation ou leur reproduction est soumise aux termes et conditions de ladite licence.

Légende de limitation des droits

Limitation des droits du Gouvernement des États-Unis. Les droits s'appliquant au logiciel et aux informations techniques concédées au gouvernement fédéral incluent uniquement les droits concédés habituellement aux clients utilisateurs. Keysight concède la licence commerciale habituelle sur le logiciel et les informations techniques suivant les directives FAR 12.211 (Informations techniques) et 12.212 (Logiciel informatique) et, pour le Ministère de la Défense, selon les directives DFARS 252.227-7015 (Informations techniques – Articles commerciaux) et DFARS 227.7202-3 (Droits s'appliquant aux logiciels informatiques commerciaux ou à la documentation des logiciels informatiques commerciaux).

Consignes de sécurité

MISE EN GARDE

La mention ATTENTION signale un danger pour le matériel. Elle attire l'attention sur une procédure ou une pratique qui, si elle n'est pas respectée ou correctement réalisée, peut se traduire par un endommagement de l'instrument ou une perte de données importante. En présence de la mention ATTENTION, il convient de ne pas continuer tant que les conditions indiquées n'ont pas été parfaitement comprises et respectées.

AVERTISSEMENT

La mention AVERTISSEMENT signale un danger pour la sécurité de l'opérateur. Elle attire l'attention sur une procédure ou une pratique qui, si elle n'est pas respectée ou correctement réalisée, peut se traduire par des accidents graves, voire mortels. En présence de la mention AVERTISSEMENT, il convient de s'interrompre tant que les conditions indiquées n'ont pas été parfaitement comprises et respectées.

Symboles de sécurité



Courant alternatif



Borne reliée au cadre ou au châssis



Alimentation en mode veille. L'appareil n'est pas complètement débranché de l'alimentation secteur si l'interrupteur est en position OFF.



AVERTISSEMENT Risque d'électrocution



MISE EN GARDE Consultez la documentation fournie



Le marquage CE est une marque déposée de la Communauté européenne.



Le marquage CSA accompagné des mentions 'c' et 'us' signifie que le produit est certifié conforme aux normes américaines et canadiennes pour le marché américain et le marché canadien, respectivement.

**CAT II
(300 V)**

Appareil de mesure de classe II conforme à la norme CEI. Les entrées peuvent être connectées à l'alimentation secteur (jusqu'à 300 Vca) dans des conditions de surtension de classe II.



Ce produit porte le marquage ACMA RCM pour indiquer sa conformité aux normes d'Australie / Nouvelle-Zélande. Une copie de la Déclaration de conformité australienne du fabricant de cet instrument peut être obtenue en contactant votre représentant local Keysight Technologies.

ISM 1-A

Ce texte indique que l'instrument est un produit industriel, scientifique et médical de classe A et du groupe 1 (CISPER 11, clause 4).

ICES/NMB-001

This ISM device complies with Canadian ICES-001.

Cet instrument ISM est conforme à la norme NMB-001 du Canada.

Informations de sécurité et réglementaires



Ce produit est conforme aux équipements marqués selon la Directive WEEE (2002/96/CE). L'étiquette apposée sur le produit indique que vous ne devez pas le jeter avec les ordures ménagères.

Pour retourner vos produits usagés, contactez votre bureau Keysight local ou consultez le site www.keysight.com/environment/product/ pour de plus amples informations.



Cet équipement appartient à la classe A adaptée à un usage professionnel et est conçu pour être utilisé dans des environnements électromagnétiques non résidentiels.

이 기기는 업무용 (A 급) 전자파적합기기로서 판매자 또는 사용자는 이 점을 주의하시기 바라며, 가정외의 지역에서 사용하는 것을 목적으로 합니다.



Contient une ou plusieurs des 6 substances dangereuses supérieures à la valeur de concentration maximale (MCV), période d'utilisation de protection environnementale (EPUP) de 40 ans.

Informations sur la sécurité

Généralités

N'utilisez ce produit que de la manière préconisée par le fabricant. Les fonctions de sécurité de ce produit peuvent être inhibées si vous ne respectez pas les consignes d'utilisation. N'installez pas de composants de rechange et n'apportez aucune modification non autorisée à l'instrument. Pour garantir les caractéristiques de sécurité de l'instrument, retournez-le à votre bureau de vente et d'après-vente Keysight Technologies le plus proche en vue d'une opération de maintenance et de réparation.

AVERTISSEMENT

Mise à la terre du produit

L'instrument est un produit de classe 1 équipé d'un jeu de cordons d'alimentation avec mise à la masse. Afin de minimiser les risques d'électrocution, son châssis et son capot sont reliés à la prise de terre de l'instrument. La broche de terre de la fiche du jeu de cordons doit être fermement raccordée à une borne de terre (terre de sécurité) au niveau de la prise de courant. Toute interruption du conducteur de protection (mise à la terre) ou tout débranchement de la borne de terre de protection vous expose à un risque d'électrocution susceptible de provoquer des blessures graves ou la mort.

AVERTISSEMENT

Nettoyage

Pour prévenir les risques d'électrocution, débranchez l'instrument de l'alimentation secteur et tous les cordons de test avant les opérations de nettoyage. Nettoyez la partie extérieure de l'instrument avec un chiffon doux non pelucheux légèrement humidifié. N'utilisez pas de lessive ou de solvant. Ne tentez aucune opération de nettoyage interne. Si nécessaire, contactez un bureau de ventes et de service après-vente Keysight Technologies pour convenir de travaux d'entretien adéquats afin de garantir la préservation des fonctions de sécurité et des performances.

AVERTISSEMENT

Cordon d'alimentation secteur

Pour mettre l'instrument hors tension, il convient de débrancher le cordon d'alimentation secteur. Assurez-vous de laisser un espace suffisant autour du cordon d'alimentation pour faciliter son débranchement du secteur. N'utilisez que le cordon d'alimentation indiqué par Keysight pour une utilisation dans le pays de destination ou un cordon présentant des caractéristiques équivalentes.

AVERTISSEMENT Ne pas démonter le capot de l'instrument

Le capot de l'instrument ne doit être retiré que par du personnel qualifié et formé à la maintenance. Entretien : Débranchez l'instrument de la prise murale, le cordon d'alimentation et retirez toutes les sondes des bornes avant de procéder à l'entretien.

AVERTISSEMENT Fusible d'alimentation secteur

Pour une protection optimale contre les incendies, ne remplacez le fusible d'alimentation que par des fusibles du type et du calibre spécifiés. L'instrument doit être débranché de l'alimentation secteur et toutes les bornes de mesure doivent être déconnectées avant de remplacer le fusible.

AVERTISSEMENT Fusible de protection de mesure du courant

Pour une protection optimale contre les incendies, ne remplacez les fusibles de protection de courant que par des fusibles du type et du calibre spécifiés. L'instrument doit être débranché de l'alimentation secteur et toutes les bornes de mesure doivent être déconnectées avant de remplacer le fusible.

AVERTISSEMENT Commutateur Front/Rear (Avant/Arrière)

Ne modifiez pas la position du commutateur Front/Rear (Avant/Arrière) sur le panneau avant si des signaux sont présents sur le jeu de bornes avant ou arrière. Le commutateur n'est pas conçu comme un multiplexeur actif. Toute commutation en présence d'un courant ou d'une haute tension risque d'endommager l'instrument et de provoquer des chocs électriques.

AVERTISSEMENT Ne pas utiliser en atmosphère explosive ou dans des environnements humides

N'utilisez pas l'instrument dans des environnements avec des gaz ou des fumées inflammables, de la vapeur ou des environnements humides. Le boîtier de l'instrument est conforme à la norme IP 20.

AVERTISSEMENT En cas de dommages

Tout instrument endommagé ou défectueux doit être désactivé et protégé contre toute utilisation involontaire jusqu'à ce qu'il ait été réparé par un technicien de maintenance qualifié.

AVERTISSEMENT Autotest

Avant de mesurer une tension ou un courant dangereux, débranchez tous les cordons de test de l'instrument, exécutez la requête TEST:ALL? depuis l'interface de commande à distance et lisez le résultat pour vérifier que l'instrument fonctionne correctement.

La requête TEST:ALL? est un autotest qui renvoie la valeur +0 si l'instrument réussit et la valeur +1 si l'instrument échoue aux tests. Vous pouvez également exécuter cette requête à partir du panneau avant en appuyant sur [Shift] > [Utility] > Test/Admin > Self Test > Full Test. Si cet autotest échoue, assurez-vous que l'instrument est réparé et qu'il réussit le test complet avant de poursuivre.

AVERTISSEMENT Mesure de l'alimentation secteur

Les bornes d'entrée HI, LO et de courant peuvent être connectées à l'alimentation secteur d'installations de classe II conformes à la norme CEI pour des tensions secteur maximales de 300 Vca. Pour éviter tout risque d'électrocution, ne connectez pas les entrées à l'alimentation secteur pour les tensions secteur supérieures à 300 Vca. Pour de plus amples informations, reportez-vous à la section **Instrument de mesure de classe de classe II conforme à la norme CEI**.

AVERTISSEMENT **Mesure de courant avec un transformateur de courant**

Si vous utilisez un transformateur de courant pour mesurer le courant, il doit être équipé d'une protection secondaire interne. L'utilisation d'un transformateur de courant sans protection peut produire des tensions dangereuses susceptibles de provoquer de graves chocs électriques ou la mort. De plus, les composants de l'instrument risquent d'être sérieusement endommagés.

AVERTISSEMENT **Facteur de crête**

Le dépassement du facteur de crête limite peut engendrer l'affichage d'une valeur inexacte ou inférieure. Ne dépassez pas le facteur de crête limite pour éviter tout endommagement de l'instrument et risque d'électrocution. Le facteur de crête limite est indiqué sur la fiche technique de l'instrument à l'adresse www.keysight.com/find/truevolt-doc.

AVERTISSEMENT **Limites de mesure**

Pour éviter tout endommagement de l'instrument et risque d'électrocution, ne dépassez pas les limites de mesure définies dans la section suivante.

MISE EN GARDE Ce produit est conforme à la norme EN/CEI 61326-2-1 relative aux instruments de contrôle et de mesure sensibles :

Lorsqu'il est soumis à des phénomènes électromagnétiques rayonnés et/ou conduits transitoires, le produit peut enregistrer une perte temporaire de ses fonctions ou performances. Un délai supérieur à 10 secondes peut être nécessaire pour rétablir ces fonctions/performances.

Lorsque le produit est soumis à des phénomènes électromagnétiques continus, un ralentissement des performances peut être observé.

MISE EN GARDE Sauf mention contraire dans les caractéristiques techniques, cet instrument ou ce système est destiné à un usage dans un local abrité, une installation de catégorie II et dans un environnement de degré de pollution 2 selon les normes CEI 61010-1 et respectivement. Il est conçu pour fonctionner avec une humidité relative maximale de 5 % à 80 % à 40 °C au maximum (sans condensation). Cet instrument ou ce système est conçu pour fonctionner jusqu'à 3 000 mètres d'altitude et à des températures comprises entre 0 °C et 55 °C.

MISE EN GARDE Cet instrument est utilisé avec une alimentation secteur de 100 - 240 V, 50/60 Hz ou 100 - 120 V, 400 Hz. La consommation électrique maximale est de 25 Va. Les fluctuations de la tension d'alimentation du réseau principal ne doivent pas dépasser $\pm 10\%$ de la principale tension nominale. Assurez-vous d'utiliser le cordon d'alimentation approprié en fonction de la puissance nominale de l'instrument et des codes électriques de votre pays.

Conformité et réglementation des produits

Les multimètres numériques de la série Truevolt sont conformes aux normes de sécurité et de CEM.

Reportez-vous à la Déclaration de conformité <http://www.keysight.com/go/conformity> pour connaître la dernière révision.

Limites de mesure

Les multimètres numériques série Truevolt incluent un circuit de protection pour éviter que l'instrument ne soit endommagé et vous protéger contre les risques d'électrocution, à condition que les limites de mesure ne soient pas dépassées. Pour garantir une utilisation sans danger de l'instrument, ne dépassez pas les limites de mesures indiquées sur le panneau avant et arrière, et définies comme suit :

Zone de bornes du
panneau avant 34460A

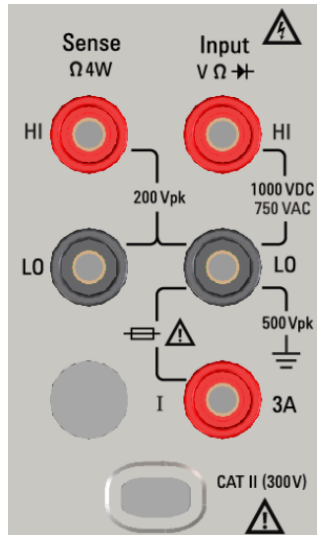

Zone de bornes du
panneau avant
34461A, 34465A, 34470A

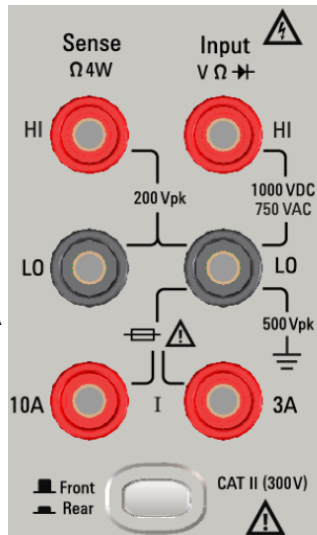

**Zone de bornes du
panneau arrière
34461A, 34465A, 34470A**

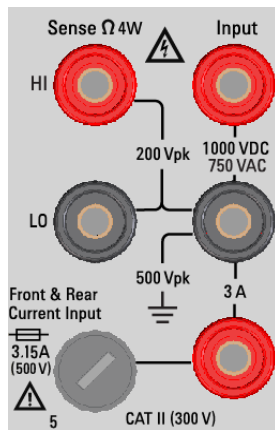

REMARQUE Sur les modèles 34461A, 34465A et 34470A, assurez-vous que le commutateur avant/arrière sélectionne le jeu de bornes désiré. N'utilisez PAS ce commutateur lorsque des signaux sont présents sur les bornes avant ou arrière.

Le fusible de protection de courant de 3 A remplaçable par l'utilisateur est situé sur le panneau arrière. L'unité comporte des fusibles de protection de courant de 3 A et 10 A (modèles 34461A, 34465A et 34470A). Pour obtenir des instructions de remplacement, contactez votre revendeur et le service après-vente Keysight ou consultez la documentation d'entretien du produit.

Pour une protection optimale, remplacez les fusibles par des **fusibles du type et du calibre spécifiés**.

Limites de mesure des bornes d'entrée

Des limites de mesure sont définies pour les bornes d'entrée :

Bornes d'entrée (HI et LO) principales. Les bornes d'entrée HI et LO sont utilisées pour les mesures de tension, de résistance, de fréquence (période) et de test de diodes. Deux limites de mesure sont définies pour ces bornes :

- **Limite de mesure entre les bornes HI et LO.** La limite de mesure entre les bornes HI et LO (bornes d'entrée) est de 1 000 Vcc ou de 750 Vca, qui correspond également à la mesure de tension maximale. Cette limite peut également être définie sur une valeur maximale de 1 000 V crête.
- **Limite de mesure entre la borne LO et la masse.** La borne d'entrée LO peut « flotter » en toute sécurité à une tension maximale de 500 V crête par rapport à la masse, où la masse est définie comme conducteur de terre de protection dans le cordon d'alimentation secteur fixé à l'instrument.

Comme l'impliquent les limites ci-dessus, la limite de mesure pour la borne d'entrée HI est tout au plus de 1 500 V crête par rapport à la masse lorsque la borne LO atteint sa valeur maximale de 500 V crête par rapport à la masse.

Borne d'entrée de courant. La borne d'entrée de courant (« I ») a une limite de mesure de 3 ou 10 A (CC ou CA) entre la borne « I » (3 A ou 10 A) et la borne d'entrée LO. Notez que les bornes d'entrée de courant présentent toujours approximativement la même tension que la borne LO, sauf si un fusible de protection de courant est ouvert. La borne de 10 A n'est pas disponible sur le modèle 34460A.

Limites de mesure des bornes de mesure

Les bornes de mesure HI et LO sont utilisées pour les mesures du rapport de tension continue et les mesures de résistance et de température à quatre fils. La limite de mesure est de 200 V crête pour tous les couplages de bornes : entre la mesure LO et l'entrée LO, entre la mesure HI et l'entrée LO, et entre les mesures HI et LO.

REMARQUE La limite de 200 V crête sur les bornes de mesure correspond à la limite de mesure. Les tensions opérationnelles des mesures de résistance sont considérablement inférieures : jusqu'à ± 12 V dans des conditions de fonctionnement normales.

Appareil de mesure de classe II conforme à la norme CEI

Pour prévenir tout risque d'électrocution, le multimètre numérique Keysight série Truevolt protège l'utilisateur contre les événements de surtension de l'alimentation secteur. Lors de la mesure de l'alimentation secteur, les bornes d'entrée HI et LO peuvent être connectées à une alimentation secteur maximale de 300 Vca dans les conditions de mesure de catégorie II définies ci-dessous.

La catégorie de mesure de la norme CEI comprend des dispositifs électriques branchés à une prise secteur sur un circuit de dérivation. Ces dispositifs incluent la plupart des petits appareils, équipements de test et autres dispositifs qui se branchent à une prise ou un connecteur de dérivation. L'instrument peut être utilisé pour effectuer des mesures avec les entrées HI et LO branchées à l'alimentation secteur de ces dispositifs ou à la prise de dérivation proprement dite (jusqu'à 300 Vca). Cependant, l'instrument ne peut pas être utilisé si ses entrées HI et LO sont branchées à l'alimentation secteur de dispositifs électriques fixes, tels que le disjoncteur du panneau principal, les tableaux de coupure du panneau secondaire ou les moteurs à câblage fixe. Ces dispositifs et circuits sont soumis à des surtensions qui peuvent dépasser les capacités de protection de l'instrument.

REMARQUE Les tensions supérieures à 300 Vca peuvent être uniquement mesurées dans des circuits isolés de l'alimentation secteur. Cependant, des surtensions transitoires sont également présentes sur les circuits qui sont isolés de l'alimentation secteur. L'instrument a été conçu pour supporter en toute sécurité des surtensions transitoires occasionnelles pouvant atteindre 1 500 V crête lors de la mesure de tensions supérieures à 300 Vca. N'utilisez pas cet équipement pour mesurer des circuits dans lesquels les surtensions transitoires pourraient dépasser ce niveau.

Jeu de cordons de test Keysight 34139A

Le jeu de cordons de test Keysight 34139A décrit ci-dessous est compatible avec les multimètres numériques série Truevolt.

Caractéristiques assignées des cordons de test

- Cordons de test - 1 000 V, 15 A
- Capuchons de sonde à pointe fine - 300 V
- Capuchon de grippe fil miniature 3 A - 300 V, 3 A
- Capuchon de grippe fil SMT - 300 V, 3 A

Utilisation

Les capuchons à pointe fine, grippe fil miniature et grippe fil SMT s'insèrent à l'extrémité des sondes des cordons de test.

Maintenance

Si une partie du jeu de cordons de test est usée ou endommagée, n'utilisez pas les cordons. Remplacez-les par un nouveau jeu de cordons de test Keysight 34139A.

AVERTISSEMENT Si le jeu de cordons de test est utilisé d'une manière non recommandée par Keysight Technologies, la protection assurée par ces cordons peut être inhibée. Aussi, n'utilisez pas de jeux de cordons de test endommagés ou usés, sous peine de provoquer des blessures ou la mort.

Déclaration de conformité

Vous pouvez télécharger sur le site Web réglementaire de Keysight les déclarations de conformité concernant ce produit et d'autres produits Keysight à l'adresse suivante :

<http://regulations.products.keysight.com/DoC/search.htm>

Bienvenue

Ce Guide d'utilisation et de maintenance contient des informations sur l'utilisation, la programmation et l'entretien des multimètres numériques Keysight série Truevolt. Pour nous faire part de vos commentaires sur ce document, rendez-vous sur www.keysight.com/find/truevolt-docfeedback.

REMARQUE Dans ce document, le terme « esclave » a été remplacé par « secondaire ».

Informations générales

Informations de sécurité et réglementaires

Modèles et options

Prise en main

Contactez Keysight Technologies

Présentation de l'instrument

Informations utilisateur

Aide-mémoire des menus du panneau avant

Caractéristiques et fonctions

Configuration de l'interface de commande à distance

Procédure de configuration du réseau local

Interface Web

Mesures

Déclenchement et lectures

Probe Hold (Maintien de la sonde)

Math (Opération mathématique)

Display (Affichage)

Menu Utility (Utilitaire)

Didacticiel de mesure

Bienvenue

Référence de programmation SCPI

Bienvenue dans SCPI

Présentation du langage SCPI

Commandes par sous-système

Aide-mémoire des commandes

Plage, résolution et NPLC

Tableau de résolution

Sortie VM Comp (Mesure terminée)

Messages d'erreur SCPI

État à la mise sous tension/réinitialisation

Entretien et réparation

Entretien et réparation

Démontage

Dépannage

Blocs d'alimentation

Procédures d'autotest

Remplacement de la batterie

Installation de l'interface GPIB en option

Pièces remplaçables par l'utilisateur

Vérification du fonctionnement

Vérification du fonctionnement

Procédures d'étalonnage

Procédures d'étalonnage

Procédures d'étalonnage des modèles 34460A et 34461A

Procédures d'étalonnage des modèles 34465A et 34470A

Mise à jour du microprogramme

Présentation de l'instrument

Les instruments Keysight Technologies 34460A/61A/65A sont des multimètres numériques 6½ chiffres ; le modèle 34470A est un multimètre numérique 7½ chiffres.

[Présentation générale de l'instrument](#)

[Bref aperçu du panneau avant](#)

[Bref aperçu du panneau arrière](#)

[Modèles et options](#)

[Contacter Keysight Technologies](#)

Présentation générale de l'instrument

L'association de fonctions d'application de laboratoire et d'intégration en système font de cet instrument une solution polyvalente répondant aux exigences présentes et futures. L'instrument peut effectuer un large éventail de mesures précises et flexibles.

Affichage – Affichez, enregistrez et documentez aisément vos résultats de mesure

- Grande convivialité via une interface utilisateur intuitive pilotée par des menus
- Vues Histogramme, Diagramme de tendance (non disponible sur le modèle 34461A), Multimètre et numérique sur un écran couleur haute résolution
- Interface USB, LAN (en option sur le modèle 34460A) et GPIB en option
- Connectivité USB sans pilote de type Glisser-déposer

Mesures – Performances de mesure Truevolt de Keysight alliées à un accès de pointe aux E/S

- Performances de niveau métrologique brevetées qui constituent la base de toutes les mesures

Langage de programmation

- Langage de programmation SCPI (Standard Commands for Programmable Instruments)

Bref aperçu du panneau avant



N°	Description
1	Port USB
2	Affichage
3	Touches de configuration des mesures et d'utilisation de l'instrument
4	Bornes de mesure HI et LO
5	Bornes d'entrée HI et LO
6	Bornes d'entrée de courant alternatif/continu (borne 10 A non disponible sur le modèle 34460A)
7	Interrupteur On/Standby (Marche/Veille)
8	Touches de fonction
9	Clavier de navigation à curseur
10	Touches de sélection des pages
11	Commutateur Front/Rear (Avant/Arrière) (34461A/65A/70A uniquement)

Touches du panneau avant

REMARQUE

Certaines touches du panneau avant sont précédées de texte. Cela indique que la touche exerce une fonction à laquelle vous pouvez accéder en appuyant sur la touche **[Shift]** et en la relâchant avant d'appuyer dessus. Par exemple, si vous appuyez sur la touche **[Shift]** et que vous la relâchez avant d'appuyer sur **[Display]**, vous accédez à la fonction **[Utility]** :



Bref aperçu du panneau arrière

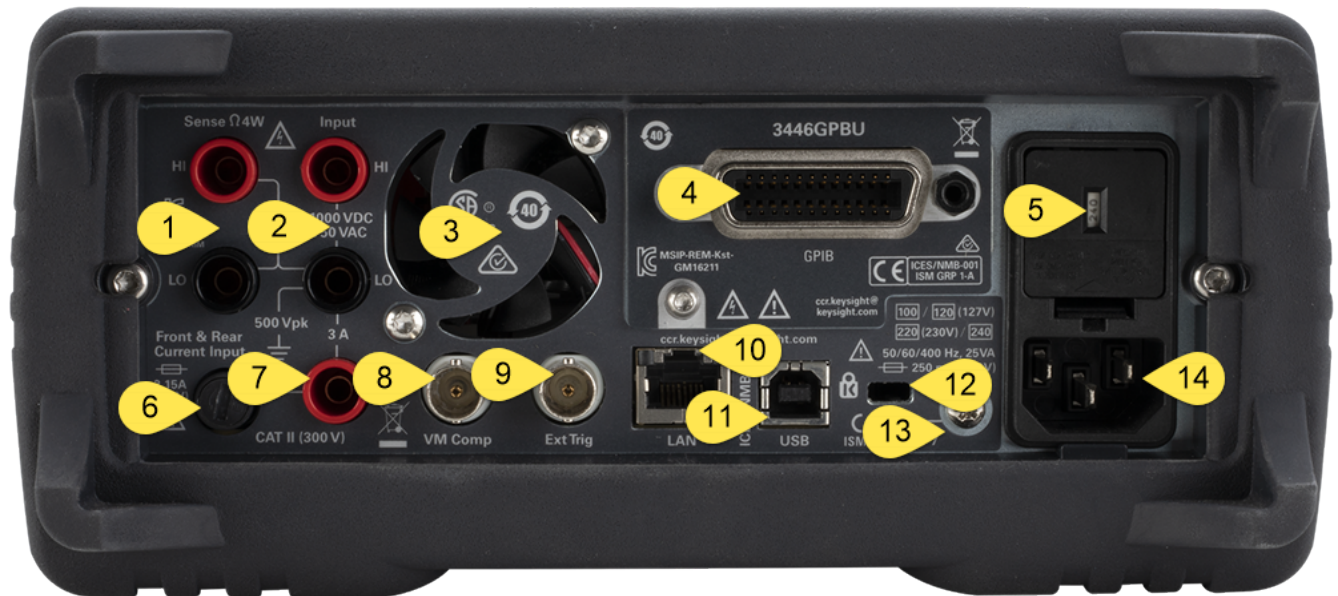

N°	Description
1	Bornes de mesure HI et LO (34461A/65A/70A uniquement)
2	Bornes d'entrée HI et LO (34461A/65A/70A uniquement)
3	Orifices de ventilation (34461A/65A/70A uniquement)
4	Connecteur GPIB (en option)
5	Sélecteur de tension d'alimentation secteur et accès aux fusibles
6	Fusible de borne de courant 3 A
7	Borne de courant 3 A (34461A/65A/70A uniquement)
8	Sortie complète de mesure du voltmètre
9	Entrée de déclenchement externe
10	Connecteur de réseau local (LAN)
11	Connecteur d'interface USB
12	Verrouillage du câble de l'instrument
13	Borne à vis de mise à la terre du châssis
14	Entrée secteur

Modèles et options

Les multimètres numériques Keysight Truevolt suivants sont disponibles :

- 34460A - Multimètre numérique de base 6½ chiffres
- 34461A - Multimètre numérique de rechange 6½ chiffres 34401A
- 34465A - Multimètre numérique 6½ chiffres
- 34470A - Multimètre numérique 7½ chiffres

Les options installées en usine et celles pouvant être installées par vous-même ou un distributeur sont répertoriées dans les tableaux ci-dessous. Vous pouvez déterminer les options installées depuis le panneau avant de l'instrument en appuyant sur **[Shift]** > **[Help]About**.

Options installées en usine

34460A	34461A	34465A	34470A	Description
34460A-LAN	*S/O - Standard	*S/O - Standard	*S/O - Standard	Interface Web LAN/LXI du panneau arrière, déclenchement externe pour le modèle 34460A.
34460A-SEC	34461A-SEC	34465A-SEC	34470A-SEC	Sécurité NISPOM et des fichiers pour la licence des multimètres numériques série Truevolt.
34460A-GPB	34461A-GPB	34465A-GPB	34470A-GPB	Module d'interface GPIB installable par l'utilisateur
34460A-ACC	*S/O - Standard	*S/O - Standard	*S/O - Standard	Kit d'accessoires pour le modèle 34460A - Cordons de test, câble USB
34460A-Z54	34461A-Z54	34465A-Z54	34470A-Z54	Certificat d'étalonnage – ANSI/NCCL Z540.3-2006, imprimé
*S/O	*S/O	34465A-DIG	34470A-DIG	Numérisation et déclenchement avancé. Maintenant inclus avec la dernière mise à jour du microprogramme.
*S/O	*S/O	34465A-MEM	34470A-MEM	Licence de mémoire de 2 Mo

Options installées par le distributeur ou le client final

Référence produit	34460A	34461A	34465A	34470A	Description
3446LANU	Option	*S/O - Standard	*S/O - Standard	*S/O - Standard	Activation de l'interface Web LAN/LXI du panneau arrière, déclenchement externe pour le modèle 34460A
3446SECU	Option	Option	Option	Option	Sécurité NISPOM et des fichiers pour la licence des multimètres numériques série Truevolt.
3446GPBU	Option	Option	Option	Option	Module d'interface GPIB installable par l'utilisateur
3446ACCU	Option	*S/O - Standard	*S/O - Standard	*S/O - Standard	Kit d'accessoires pour le modèle 34460A - Cordons de test, câble USB

Référence produit	34460A	34461A	34465A	34470A	Description
3446MEMU	*S/O	*S/O	Option	Option	Mémoire de 2 Mo pour la licence des multimètres numériques 34465A et 34470A série Truevolt.

*S/O = Sans objet.

Configuration de l'interface de commande à distance

REMARQUE Si l'option de sécurité est installée sur votre instrument, vous devez déverrouiller ce dernier à l'aide du code de sécurité pour effectuer la plupart de ces actions.

L'instrument prend en charge les communications avec l'interface de commande à distance sur 3 interfaces : GPIB (en option), USB et LAN (en option sur le modèle 34460A). Ces trois interfaces sont « actives » à la mise sous tension lorsque l'instrument quitte l'usine.

- **Interface GPIB** : Configurez l'adresse GPIB de l'instrument et connectez ce dernier à l'ordinateur au moyen d'un câble GPIB.
- **Interface USB** : Utilisez le connecteur USB du panneau arrière pour communiquer avec votre ordinateur. Pour de plus amples informations, reportez-vous à la section **Paramètres USB**.
- **Interface LAN** : Par défaut, le protocole DHCP est activé pour permettre les communications sur un réseau local. DHCP est l'abréviation de Dynamic Host Configuration Protocol ; il s'agit d'un protocole d'attribution d'adresses IP dynamiques IP à des périphériques en réseau. Avec l'adressage dynamique, un périphérique peut avoir une adresse IP différente chaque fois qu'il se connecte au réseau.

Logiciel de connectivité

- L'instrument est livré avec le **CD-ROM Keysight Automation-Ready**. Ce CD-ROM contient le logiciel Keysight IO Libraries Suite qui doit être installé pour les opérations sur l'interface de commande à distance. Il démarre automatiquement et contient des informations sur l'installation du logiciel. Il contient également le manuel *Keysight Technologies USB/LAN/GPIB Connectivity Guide* qui fournit des informations complémentaires.

Configuration GPIB

Chaque périphérique connecté à l'interface GPIB (IEEE-488) doit avoir une adresse unique comprise entre 0 et 30. L'instrument est livré avec l'adresse 10 par défaut et l'adresse GPIB est affichée à la mise sous tension.

- Ce paramètre est non volatile ; il n'est pas altéré par une remise sous tension ou l'exécution de la commande ***RST** ou **SYSTem:PRESet**.
- L'interface GPIB de votre ordinateur ne doit pas interférer avec un instrument sur le bus de l'interface.
- **Panneau avant** : Appuyez sur **[Utility] > I/O Config > LAN Settings**. Dans ce menu, vous pouvez définir l'adresse GPIB et activer/désactiver l'interface GPIB. Une fois les modifications terminées, vous devez remettre l'instrument sous tension pour que la modification soit prise en compte.
- **SCPI** :
SYSTem:COMMunicate:GPIB:ADDRes <adresse>
SYSTem:COMMunicate:ENABLE {ON|1|OFF|0}GPIB

Configuration LAN

Les sections suivantes décrivent les principales fonctions de configuration du réseau local sur le panneau avant, notamment les commandes SCPI applicables. Certaines fonctions de configuration LAN peuvent être uniquement exécutées via des commandes SCPI. Reportez-vous à la section **Sous-système SYSTem - Configuration des E/S** pour une description des commandes de configuration LAN, et à la section **Procédure de configuration LAN** pour configurer le réseau local via le panneau avant.

REMARQUE

Certains paramètres LAN requièrent une remise sous tension de l'instrument pour être activés. L'instrument affiche brièvement un message dans ce cas ; examinez donc attentivement l'écran lorsque vous modifiez les paramètres LAN.

Réinitialisation du réseau local

Vous pouvez effacer le mot de passe de l'interface Web, activer le protocole DHCP et redémarrer le réseau local à tout moment :

- **Panneau avant** : [Utility] > I/O Config > LAN Reset

Le message « Performing LAN Reset » (Réinitialisation du réseau local) s'affiche pendant la réinitialisation du réseau local.

- **SCPI** : LXI:RESet

Activation/Désactivation de DHCP

Le protocole DHCP (Dynamic Host Configuration Protocol) affecte automatiquement une adresse IP dynamique à un périphérique sur le réseau local. C'est généralement la manière la plus simple de configurer l'instrument pour le réseau local.

- Ce paramètre est non volatile ; il n'est pas altéré par une remise sous tension ou l'exécution de la commande *RST ou SYSTem:PRESet.
- **Panneau avant** : [Utility] > I/O Config > LAN Settings > Modify Settings
Enfin, configurez la première touche de fonction sur DHCP pour utiliser le protocole DHCP et affecter automatiquement une adresse IP.
- **SCPI** : SYSTem:COMMunicate:LAN:DHCP {ON|1|OFF|0}
- Si vous modifiez ce paramètre, vous devez appuyer sur la touche de fonction **Apply Changes** (panneau avant) ou envoyer la commande SYSTem:COMMunicate:LAN:UPDate (interface de commande à distance) pour que la modification soit prise en compte.

Pour configurer manuellement une adresse IP, un masque de sous-réseau ou une passerelle par défaut, désactivez le protocole DHCP, puis procédez comme suit pour modifier l'adresse IP.

Adresse IP

Vous pouvez saisir une adresse IP statique pour l'instrument sous la forme de 4 octets avec la notation par points. Chaque octet est une valeur décimale sans zéro initial (ex. 169.254.2.20).

- Si le protocole DHCP est activé, il essaie d'affecter une adresse IP à l'instrument. Si le protocole DHCP échoue, Auto-IP essaie d'affecter une adresse IP à l'instrument.
- Contactez votre administrateur réseau pour obtenir une adresse IP.
- Ce paramètre est non volatile ; il n'est pas altéré par une remise sous tension ou l'exécution de la commande ***RST** ou **SYSTem:PRESet**.
- **Panneau avant :[Utility] > I/O Config > LAN Settings > Modify Settings**
Puis, configurez la première touche de fonction sur **Manualet** appuyez sur **IP Address** pour saisir une nouvelle adresse IP.
- **SCPI : SYSTem:COMMunicate:LAN:IPADdress "<adresse>"**
- Si vous modifiez ce paramètre, vous devez appuyer sur la touche de fonction **Apply Changes** (panneau avant) ou envoyer la commande **SYSTem:COMMunicate:LAN:UPDate** (interface de commande à distance) pour que la modification soit prise en compte.

Masque de sous-réseau

Le masque de sous-réseau permet à l'administrateur réseau de sous-diviser un réseau pour simplifier sa gestion et minimiser le trafic sur le réseau. Le masque de sous-réseau indique la partie de l'adresse de l'hôte utilisée pour désigner le sous-réseau.

- Pour de plus amples informations, contactez votre administrateur réseau.
- Ce paramètre est non volatile ; il n'est pas altéré par une remise sous tension ou l'exécution de la commande ***RST** ou **SYSTem:PRESet**.
- **Panneau avant :[Utility] > I/O Config > LAN Settings > Modify Settings**
Configurez ensuite la première touche de fonction sur **Manual** et appuyez sur **Subnet Mask** pour saisir un nouveau masque de sous-réseau à l'aide des touches fléchées (par exemple : 255.255.0.0).
- **SCPI : SYSTem:COMMunicate:LAN:SMASK "<masque>"**
- Si vous modifiez ce paramètre, vous devez appuyer sur la touche de fonction **Apply Changes** (panneau avant) ou envoyer la commande **SYSTem:COMMunicate:LAN:UPDate** (interface de commande à distance) pour que la modification soit prise en compte.

Passerelle par défaut

Une passerelle est un périphérique de connexion au réseau. La passerelle par défaut est l'adresse IP de ce périphérique.

- Vous n'avez pas besoin de configurer l'adresse d'une passerelle si vous utilisez DHCP.
- Pour de plus amples informations, contactez votre administrateur réseau.
- Ce paramètre est non volatile ; il n'est pas altéré par une remise sous tension ou l'exécution de la commande ***RST** ou **SYSTem:PRESet**.
- **Panneau avant :[Utility] > I/O Config > LAN Settings > Modify Settings**
Configurez ensuite la première touche de fonction sur **Manual** et appuyez sur **More** et **Gateway**. Puis, configurez l'adresse de passerelle appropriée à l'aide des touches fléchées.
- **SCPI : SYSTem:COMMunicate:LAN:GATeway "<adresse>"**
- Si vous modifiez ce paramètre, vous devez appuyer sur la touche de fonction **Apply Changes** (panneau avant) ou envoyer la commande **SYSTem:COMMunicate:LAN:UPDate** (interface de commande à distance) pour que la modification soit prise en compte.

Nom d'hôte

Un nom d'hôte est la partie hôte du nom du domaine qui est traduite en adresse IP.

- L'instrument reçoit en usine un nom d'hôte unique que vous pouvez modifier. Ce nom doit être unique sur le réseau.
- Le nom doit commencer par une lettre ; les autres caractères peuvent être des majuscules ou des minuscules, des chiffres ou des traits d'union (« - »).
- Ce paramètre est non volatile ; il n'est pas altéré par une remise sous tension ou l'exécution de la commande ***RST** ou **SYSTem:PRESet**.
- **Panneau avant :[Utility] > I/O Config > LAN Settings > Modify Settings**
Appuyez ensuite sur **Host Name** et saisissez le nom d'hôte à l'aide des touches fléchées du panneau avant.
- **SCPI : SYSTem:COMMunicate:LAN:HOSTname "<nom>"**
- Si vous modifiez ce paramètre, vous devez appuyer sur la touche de fonction **Apply Changes** (panneau avant) ou envoyer la commande **SYSTem:COMMunicate:LAN:UPDate** (interface de commande à distance) pour que la modification soit prise en compte.

Nom de domaine

Un nom de domaine est un nom Internet enregistré qui est traduit en adresse IP. Vous pouvez le configurer sur le panneau avant ou avec une commande SCPI.

Serveur DNS

DNS (Domain Name Service) est un service Internet qui convertit les noms de domaine en adresses IP. L'adresse du serveur DNS est l'adresse IP d'un serveur qui fournit ce service.

- Normalement, DHCP recherche l'adresse DNS ; il vous suffit d'indiquer si le protocole DHCP est inutilisé ou non fonctionnel. Pour de plus amples informations, contactez votre administrateur réseau.
- Ce paramètre est non volatile ; il n'est pas altéré par une remise sous tension ou l'exécution de la commande ***RST** ou **SYSTem:PRESet**.
- **Panneau avant** : [Utility] > I/O Config > LAN Settings > Modify Settings
Configurez ensuite la première touche de fonction sur **Manual** et appuyez sur les touches **More** et **Primary DNS** ou sur la touche **Second DNS** pour saisir une adresse DNS à l'aide des touches fléchées du panneau avant.
- **SCPI** : **SYSTem:COMMunicate:LAN:DNS[*{1|2}*] "<adresse>"**
- Si vous modifiez ce paramètre, vous devez appuyer sur la touche de fonction **Apply Changes** (panneau avant) ou envoyer la commande **SYSTem:COMMunicate:LAN:UPDate** (interface de commande à distance) pour que la modification soit prise en compte.

Configuration active (LAN)

- Appuyez sur [Utility] > I/O Config > LAN Settings pour afficher l'adresse MAC et la configuration active du réseau local. Il n'existe pas de commande SCPI équivalente.
- Si l'instrument passe en mode de commande à distance, toutes les modifications du réseau local sont annulées et l'écran change. Si vous sélectionnez à nouveau la page LAN Settings, les nouveaux paramètres sont affichés si un redémarrage du réseau a lieu.

Interface Web

L'instrument intègre une interface Web pour l'accès et le contrôle à distance de l'instrument sur un réseau local via un navigateur Web. Pour de plus amples informations, reportez-vous à la section **Interface Web**.

Procédure de configuration du réseau local

Vous devrez éventuellement définir plusieurs paramètres pour établir une communication réseau via l'interface LAN. Tout d'abord, vous devrez configurer une adresse IP. Vous devrez peut-être contacter votre administrateur réseau qui vous aidera à établir les communications avec l'interface LAN.

REMARQUE Si votre instrument inclut l'option Secure (SEC), vous devez le déverrouiller pour modifier la plupart des paramètres du réseau local.

1. Appuyez sur **Press [Utility] > I/O Config > LAN Settings**.
2. Vous pouvez sélectionner **Modify Settings** pour modifier les paramètres du réseau local, ou bien activer/désactiver l'option LAN Services ou rétablir les paramètres réseau par défaut.

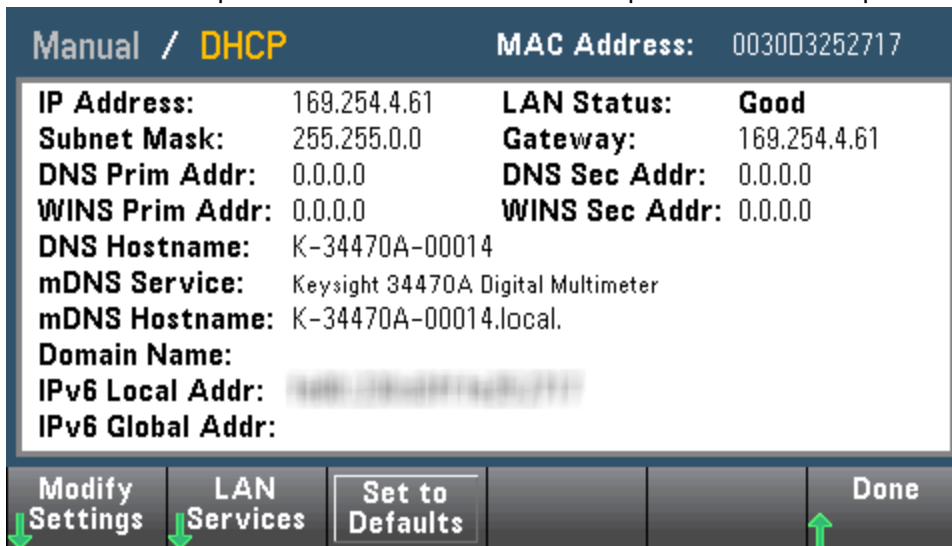

3. Pour modifier les paramètres TCP/IP, appuyez sur **Modify Settings**. Pour accéder à la plupart des paramètres de cet écran, utilisez la première touche de fonction pour passer de **DHCP** à **Manual**. Si l'option DHCP est activée, une adresse IP est automatiquement configurée par DHCP (Dynamic Host Configuration Protocol) lorsque vous connectez l'instrument au réseau, à condition que le serveur DHCP soit détecté et qu'il soit en mesure d'effectuer cette opération. Par ailleurs, le protocole DHCP gère automatiquement le masque de sous-réseau, l'adresse de la passerelle, les serveurs DNS et WINS et le domaine, si nécessaire. Il s'agit de la manière la plus facile d'établir une communication avec le réseau local pour votre instrument ; Il vous suffit de laisser l'option DHCP activée. Pour de plus amples informations, contactez votre administrateur réseau.
4. **Définissez une « configuration IP ».**
Si vous n'utilisez pas l'option DHCP (première touche de fonction sur **Manuel**), vous devez spécifier une configuration IP, y compris une adresse IP, et éventuellement un masque de sous-réseau et l'adresse d'une passerelle. Les boutons **IP Address** et **Subnet Mask** sont situés sur l'écran principal. Appuyez sur bouton **More** pour configurer la passerelle.

Contactez votre administrateur réseau pour obtenir l'adresse IP, le masque de sous-réseau et la passerelle à utiliser. Toutes les adresses IP sont exprimées sous la forme « nnn.nnn.nnn.nnn », « nnn » étant la valeur décimale d'un octet compris entre 0 et 255. Vous pouvez saisir une nouvelle adresse IP à l'aide des touches fléchées du panneau avant. **Ne saisissez pas de zéro au début des nombres.**

5. **Paramétrez la « configuration DNS » (option).**

DNS (Domain Name Service) est un service Internet qui traduit les noms de domaines en adresses IP. Demandez à votre administrateur réseau si ce service est utilisé ; si tel est le cas, demandez le nom de l'hôte, le nom du domaine et l'adresse du serveur à utiliser.

- a. Configurez le « nom d'hôte ». Appuyez sur **Host Name** et saisissez ce nom. Un nom d'hôte est la partie hôte du nom du domaine qui est traduite en adresse IP. Vous saisissez le nom de l'hôte sous la forme d'une chaîne de caractères à l'aide des touches fléchées du panneau avant pour sélectionner et modifier les caractères. Le nom de l'hôte peut contenir des lettres, des chiffres et des traits d'union (« - »).
- b. Configurez les adresses « Serveur DNS ». Sur l'écran de configuration du réseau, appuyez sur **More** pour accéder au deuxième ensemble de touches de fonction.

Entrez les serveurs DNS principal et secondaire. Consultez votre administrateur réseau pour de plus amples informations.

En savoir plus sur les adresses IP et leur notation

Les adresses notées par points (« nnn.nnn.nnn.nnn » où « nnn » est la valeur d'un octet comprise entre 0 et 255) doivent être soigneusement exprimées du fait que la plupart des logiciels des PC interprètent les octets avec des zéros initiaux comme des nombres en base 8. Par exemple, « 192.168.020.011 » est équivalent à la notation décimale « 192.168.16.9 » car « .020 » est interprété comme « 16 » en base 8 et « .011 » comme « 9 ». Pour éviter toute confusion, utilisez uniquement des valeurs décimales comprises entre 0 et 255 sans zéro d'en-tête.

Mise à jour du microprogramme

Pour mettre à jour le microprogramme de l'instrument, procédez comme suit :

MISE EN GARDE Ne mettez pas l'instrument hors tension pendant la mise à jour.

1. Appuyez sur **[Help]** > **About** pour déterminer la version du microprogramme de l'instrument actuellement installée.
2. Visitez la page www.keysight.com/find/truevolt et utilisez les liens disponibles pour obtenir la dernière version du microprogramme. Si elle correspond à la version installée sur votre instrument, il n'est pas nécessaire de poursuivre cette procédure. Sinon, téléchargez l'utilitaire de mise à jour du microprogramme et un fichier ZIP du microprogramme. Vous trouverez les instructions détaillées du microprogramme à la section *Instructions de l'utilitaire de mise à jour du microprogramme* de la page de téléchargement.
3. Décompressez le fichier ZIP et exécutez l'utilitaire de mise à jour du microprogramme pour préparer une clé USB avec le microprogramme mis à jour :
4. Branchez la clé USB au panneau avant de l'instrument et appuyez sur **[Utility]** > **Test / Admin** > **Firmware Update** pour mettre à jour le microprogramme. Si l'option de sécurité est installée, déverrouillez l'instrument à l'aide du code de sécurité avant d'installer le microprogramme.

Important : Pour mettre à jour le microprogramme de l'instrument à *partir de l'interface de commande à distance*, le numéro de modèle de la réponse ***IDN?** doit correspondre à celui de l'instrument réel. Si vous avez remplacé la réponse ***IDN?** de l'instrument par celle d'un autre instrument, lors de la tentative de mise à jour du microprogramme à partir de l'interface de commande à distance, l'erreur suivante s'affiche : *The instrument is not supported by this firmware file (L'instrument n'est pas pris en charge par ce fichier de microprogramme)*. Pour mettre le microprogramme à jour, suivez la procédure indiquée sur le panneau avant ou, dans l'interface de commande à distance, utilisez la commande **SYSTem:IDENtify** pour définir la réponse ***IDN?** afin qu'elle corresponde au numéro de modèle réel, mettez le microprogramme à jour, puis réutilisez la commande **SYSTem:IDENtify** pour définir la réponse ***IDN?** sur l'autre numéro de modèle.

Contactez Keysight Technologies



Vous pouvez contacter Keysight Technologies pour toute information sur la garantie, les services ou l'assistance technique.

Aux États-Unis : (800) 829-4444

En Europe : 31 20 547 2111

Au Japon : 0120-421-345

Pour contacter Keysight dans le monde entier ou votre représentant Keysight Technologies, rendez-vous sur www.keysight.com/find/assist.

Prise en main

Cette section décrit les procédures de base vous permettant de commencer à utiliser rapidement l'instrument.

- [Préparation de l'instrument avant utilisation](#)
- [Réglage de la poignée de transport](#)
- [Utilisation du système d'aide intégrée](#)
- [Montage de l'instrument dans une baie](#)

Préparation de l'instrument avant utilisation

Vérifiez que vous avez bien reçu les éléments suivants. Si l'un des éléments est manquant, contactez votre représentant local Keysight ou votre revendeur autorisé Keysight.

- Cordon d'alimentation (adapté au pays de destination)
- Certificat d'étalonnage (en option)
- *CD Keysight Automation-Ready* (en anglais) (contient le logiciel Keysight IO Libraries Suite) (en option sur le modèle 34460A)
- Dossier de documentation supplémentaire
- Câble USB 2.0 (en option sur le modèle 34460A)

La dernière documentation du produit est disponible à l'adresse www.keysight.com/find/truevolt-doc. Pour consulter la documentation des appareils mobiles, rendez-vous sur www.keysight.com/find/truevolt-mobilehelp.

Pour télécharger l'utilitaire Digital Multimeter Connectivity, rendez-vous sur www.keysight.com/find/DMMutilitysoftware.

Réglage du sélecteur de tension d'alimentation secteur et installation des fusibles

AVERTISSEMENT

Avant de brancher l'instrument à l'alimentation secteur, vérifiez que le sélecteur de tension d'alimentation situé à l'arrière du module d'entrée secteur est correctement positionné pour la source d'alimentation secteur connectée. Les sélections de tension d'alimentation secteur sont indiquées dans un encadré du panneau arrière, immédiatement à gauche du module d'entrée secteur. Les autres tensions d'alimentation secteur nominales sont indiquées entre parenthèses.

Vérifiez que le fusible approprié est installé. Pour remplacer un fusible grillé ou vérifier que le fusible approprié est utilisé, tirez-le délicatement du compartiment à fusible et insérez le bon fusible. Utilisez uniquement un fusible certifié de 250 V, 0,25 A à action différée de 5x20 mm. Le numéro de référence Keysight est 2110-0817.

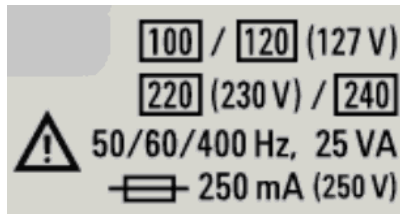

Plage de tension d'alimentation secteur nominale	Sélecteur de tension d'alimentation secteur
100 - 115	100
120 - 127	120
202 - 230	220
240	240

Pour configurer le sélecteur de tension d'alimentation, procédez comme suit :

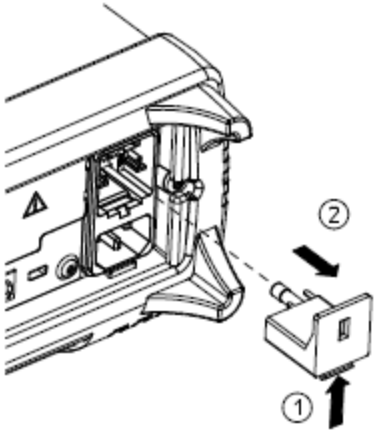
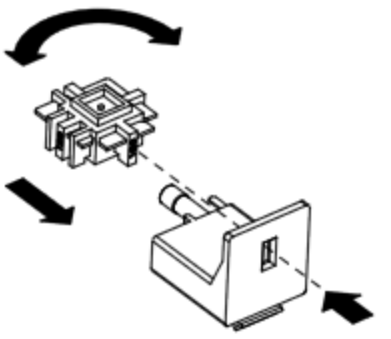
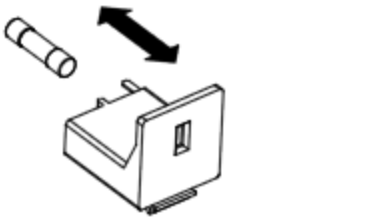
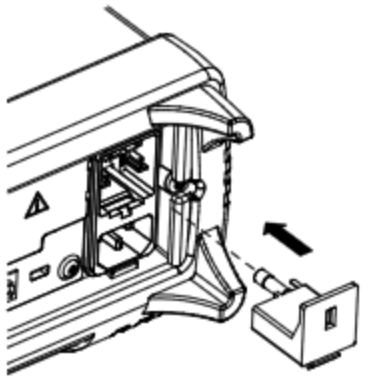
Étape 1	Soulevez la patte (1) et retirez le compartiment à fusible (2) du panneau arrière.	
Étape 2	Retirez le sélecteur de tension d'alimentation et tournez-le afin que la tension correcte apparaisse dans la fenêtre du porte-fusible.	
Étape 3	Vérifiez que le fusible approprié est installé. Pour remplacer un fusible grillé ou vérifier que le fusible approprié est utilisé, tirez-le délicatement du compartiment à fusible et insérez le bon fusible. Utilisez uniquement un fusible certifié de 250 V, 0,25 A à action différée de 5x20 mm. Le numéro de référence Keysight est 2110-0817.	
Étape 4	Reposez l'ensemble porte-fusible en le faisant glisser dans le panneau arrière.	

AVERTISSEMENT Mise à la terre du produit

L'instrument est un produit de classe 1 équipé d'un jeu de cordons d'alimentation avec mise à la masse. Afin de minimiser les risques d'électrocution, son châssis et son capot sont reliés à la prise de terre de l'instrument. La broche de terre de la fiche du jeu de cordons doit être fermement raccordée à une borne de terre (terre de sécurité) au niveau de la prise de courant. Toute interruption du conducteur de protection (mise à la terre) ou tout débranchement de la borne de terre de protection vous expose à un risque d'électrocution susceptible de provoquer des blessures graves ou la mort.

Branchement du cordon d'alimentation et des câbles d'E/S

Branchez le cordon d'alimentation et le câble de réseau local (LAN), GPIB ou USB selon les besoins. Une fois l'instrument allumé (comme décrit ci-dessous), il effectue un autotest à la mise sous tension, puis affiche un message qui explique comment obtenir de l'aide ainsi que l'adresse IP actuelle. Il affiche également l'adresse GPIB (le cas échéant).

La fonction de mesure par défaut de l'instrument est DC Voltage (DCV) (Tension continue (V CC)), avec la commutation automatique de plage activée.

Interrupteur d'alimentation

Appuyez sur l'interrupteur d'alimentation dans l'angle inférieur gauche du panneau avant. Si l'instrument ne s'allume pas, vérifiez que le cordon d'alimentation est solidement raccordé, que le fusible fonctionne correctement et que le sélecteur de tension d'alimentation secteur est correctement réglé, comme décrit ci-dessus. Vérifiez également que l'instrument est connecté à une source d'alimentation sous tension. Si le voyant situé sous l'interrupteur d'alimentation est éteint, aucune prise d'alimentation secteur n'est branchée. Si le voyant est orange, l'instrument est alimenté en courant secteur et en veille ; s'il s'allume en vert, l'instrument est en service.

REMARQUE Dans certains cas, le voyant orange peut s'allumer, même si la tension secteur incorrecte est sélectionnée. Dans ce cas, il est possible que l'instrument ne s'allume pas.

Si l'autotest à la mise sous tension échoue, le message **Error** (Erreur) s'affiche dans l'angle supérieur droit de l'écran. Un message décrivant l'erreur est également affiché. Pour de plus amples informations sur les codes d'erreur, reportez-vous à la section [Messages d'erreur SCPI](#). Pour des instructions sur le renvoi de l'instrument pour entretien, reportez-vous à la section [Entretien et réparation - Introduction](#).

Pour mettre l'instrument hors tension, appuyez sur l'interrupteur d'alimentation en le maintenant enfoncé pendant environ 500 ms. Cela évite d'éteindre accidentellement l'instrument en appuyant brièvement sur l'interrupteur.

REMARQUE Si vous éteignez l'instrument en débranchant la prise d'alimentation (procédure déconseillée), il s'allume dès l'alimentation rétablie. Il n'est pas nécessaire d'appuyer sur l'interrupteur.

Réglage de la poignée de transport

La poignée comporte trois positions, illustrées ci-dessous.

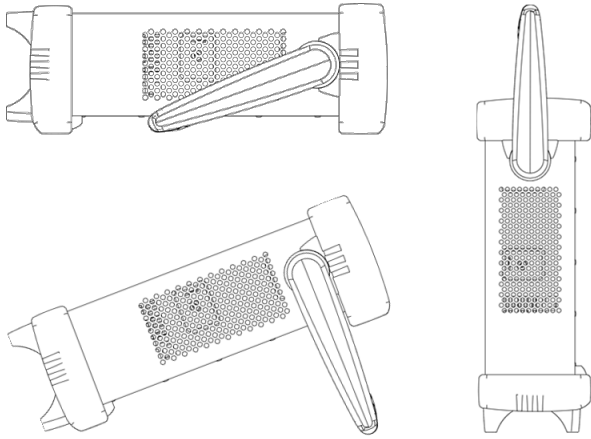

Pour régler la position de la poignée, saisissez les bords de la poignée, tirez vers l'extérieur et faites tourner la poignée.

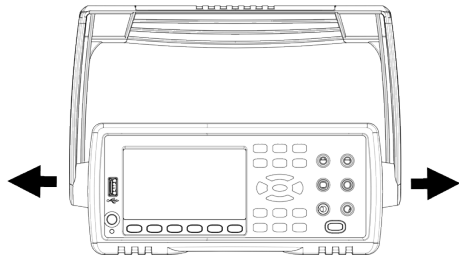

Utilisation du système d'aide intégrée

Le système d'aide intégré fournit une aide contextuelle sur toutes les touches du panneau avant et les touches de fonction des menus. Une liste de rubriques d'aide vous permettant de mieux comprendre le fonctionnement de l'instrument est également disponible.

Affichage de l'aide sur une touche du panneau avant

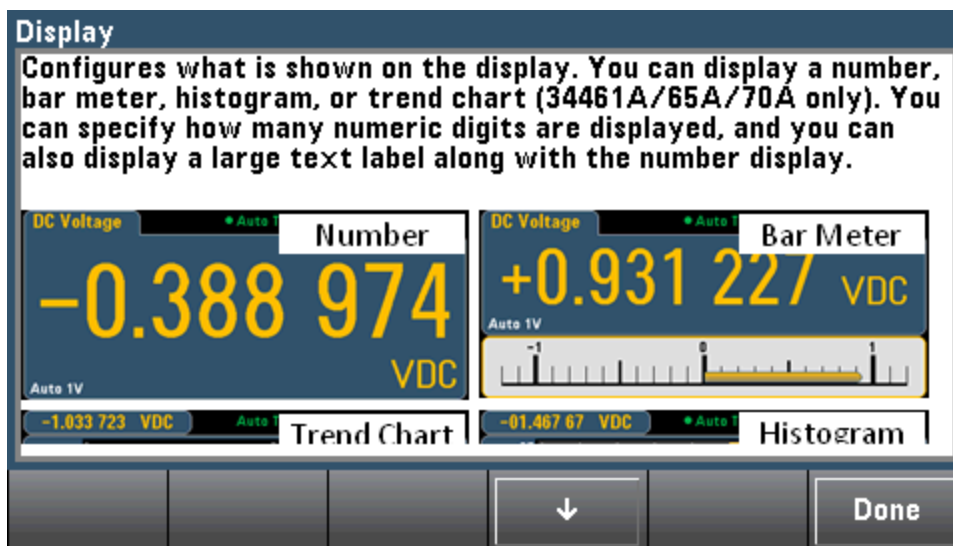

Appuyez sur une touche de fonction ou un bouton (ex. [**Display**]) et maintenez-les enfoncés.

Si le message contient plus d'informations que ne peut en afficher l'écran, appuyez sur la touche de fonction fléchée vers le bas pour le parcourir.



Appuyez sur **Done** pour quitter l'aide.

Affichage de la liste des rubriques d'aide et utilisation des démonstrations interactives

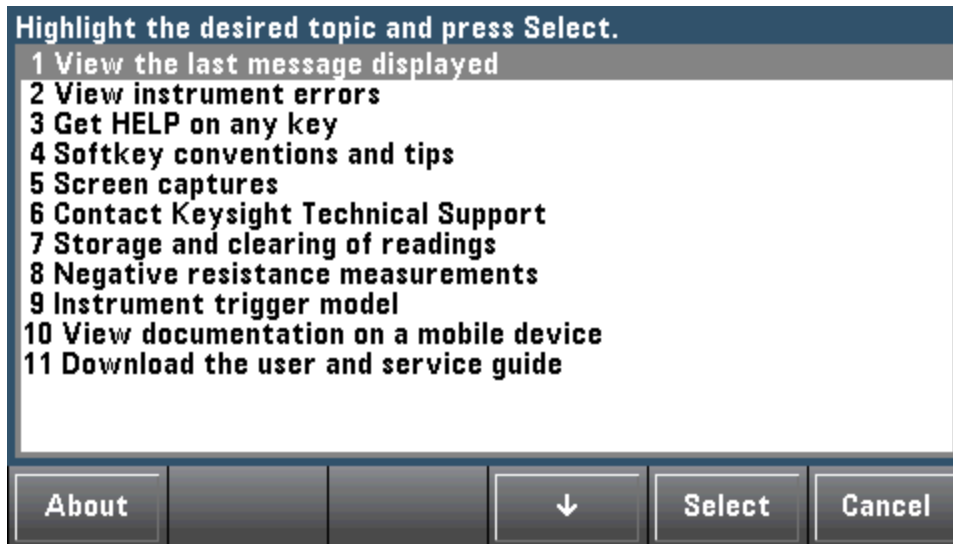

Appuyez sur   pour afficher la liste des rubriques d'aide. Appuyez sur les touches de fonction fléchées ou utilisez les touches fléchées du panneau avant pour mettre en surbrillance la rubrique désirée. Appuyez ensuite sur **Select**. Vous pouvez également appuyer sur la touche **Demos** pour exécuter des démonstrations interactives sur l'utilisation de l'instrument.

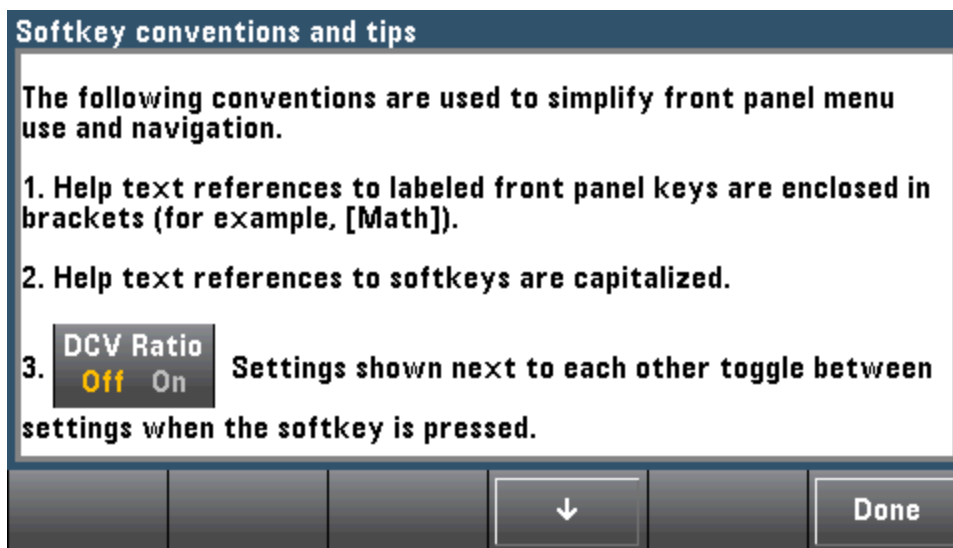

Dans ce cas, la rubrique d'aide suivante apparaît :



Affichage de la liste des erreurs récentes de l'instrument

Appuyez sur   et choisissez **View instrument errors** dans la liste des rubriques d'aide. La file d'erreurs de l'instrument qui contient jusqu'à 20 erreurs s'affiche.

Affichage de l'aide sur les messages

Lorsqu'une limite est dépassée ou qu'une autre configuration incorrecte est détectée, l'instrument affiche un message. Le système d'aide intégré fournit des informations supplémentaires sur le dernier message. Appuyez sur **[Shift] > [Help]**, sélectionnez **View the last message displayed**, puis appuyez sur **Select**.

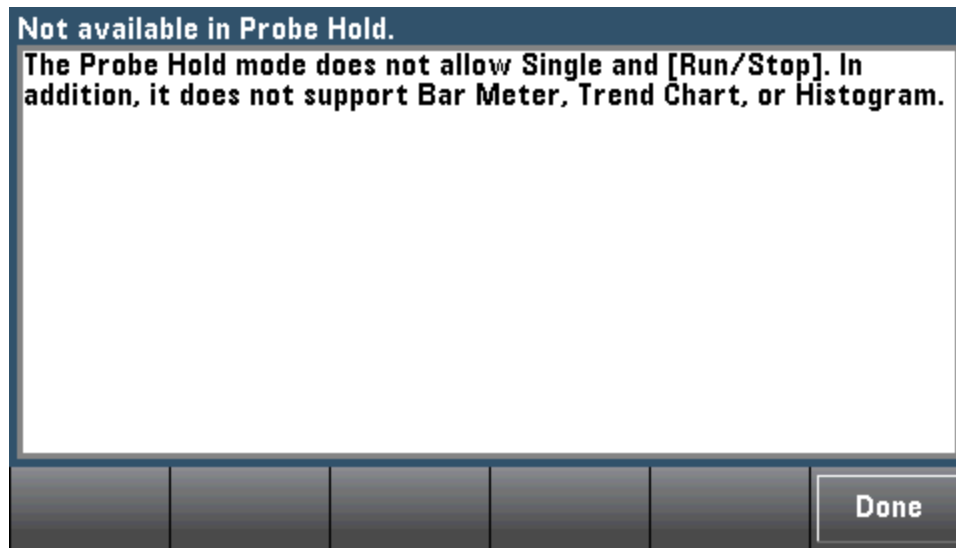

Appuyez sur **Done** pour quitter l'aide.

REMARQUE

Aide dans votre langue

Tous les messages, l'aide contextuelle et les rubriques d'aide existent dans les langues suivantes : Anglais, Chinois, Français, Allemand, Japonais, Coréen et Russe. Pour sélectionner une langue, appuyez sur **[Utility] > System Setup > User Settings > Help Lang**. Sélectionnez ensuite la langue désirée.

Les libellés des touches de fonction des menus et les messages des lignes d'état ne sont pas traduits.

Montage de l'instrument dans une baie

Vous pouvez installer l'instrument dans une armoire standard 19 pouces à l'aide d'un des deux kits disponibles en option. Chacun de ces kits contient des instructions et le matériel nécessaire au montage. Vous pouvez également monter un autre instrument Keysight System II de hauteur et largeur identiques à côté de l'instrument.

MISE EN GARDE

Pour éviter toute surchauffe de l'instrument, ne bloquez pas les entrées et sorties d'air de l'instrument. Laissez suffisamment d'espace à l'arrière, sur les côtés et sous l'instrument afin de permettre une ventilation interne adéquate.

REMARQUE

Déposez la poignée de transport et les plots en caoutchouc avant et arrière avant de monter l'instrument dans une baie.

Dépose de la poignée et des plots

Pour déposer la poignée, tournez-la à la verticale et tirez les extrémités vers l'extérieur.

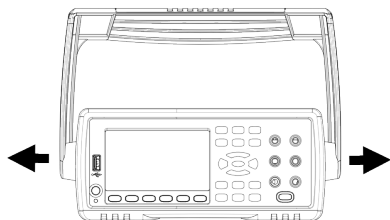

Pour retirer le plot en caoutchouc, étirez un coin et faites-le glisser vers l'extérieur.

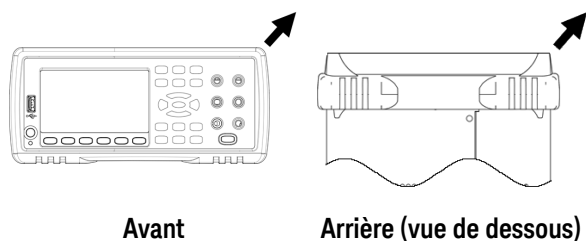

Avant

Arrière (vue de dessous)

Montage d'un instrument unique dans une baie

Pour monter un seul instrument dans une baie, commandez le kit de montage 5063-9240.

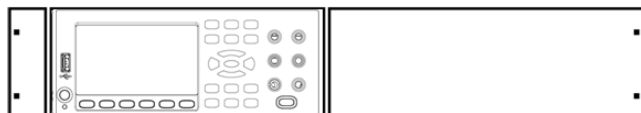

Retrait des vis latérales et des rondelles du panneau avant

REMARQUE

Cette étape est valable pour les modèles d'instrument dont le numéro de série est indiqué ci-dessous :

- 34461A et 34470A : numéro de série MY60020599 et supérieur
- 34460A et 34465A : numéro de série MY60016557 et supérieur

Pour retirer les vis latérales et les rondelles, utilisez un tournevis Pozi, calibre 2.

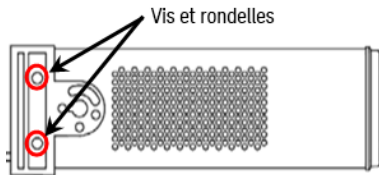

Montage d'instruments côte-à-côte dans une baie

Pour installer deux instruments côte à côte dans une baie, commandez le kit de liaison 50618769 et le kit de cornières 5063-9212. Assurez-vous de pouvoir utiliser les rails supports internes à l'armoire de baie.

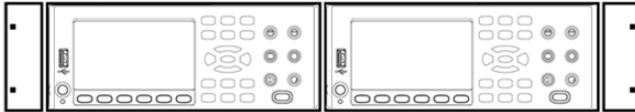

Étagère coulissante

Pour installer un ou deux instruments sur une étagère coulissante, commandez l'étagère 5063-9255 et le kit de glissières 1494-0015. Pour un seul instrument, commandez également le panneau aveugle 5002-3999.

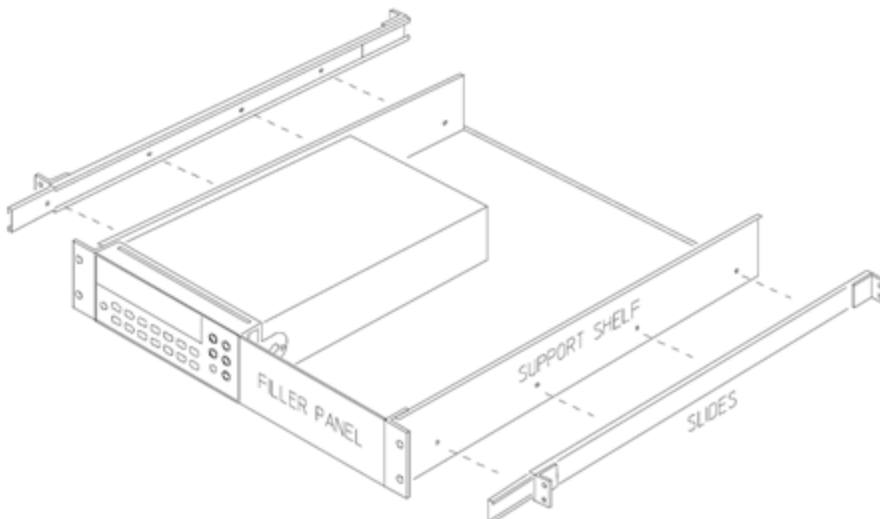

Caractéristiques et fonctions

Cette rubrique détaille les caractéristiques de l'instrument, notamment l'utilisation des commandes du panneau avant et de l'interface de commande à distance. Reportez-vous d'abord à la section **Référence des menus du panneau avant**. Pour plus d'informations sur les commandes et les requêtes SCPI, reportez-vous à la section **Présentation du langage SCPI**.

Sujets traités :

Aide-mémoire des menus du panneau avant

Mesures

Déclenchement et lectures

Probe Hold (Maintien de la sonde)

Menu Math (Opération mathématique)

Menu Display (Affichage)

Menu Utility (Utilitaire)

Interface Web

Dans ce document, les états et les valeurs « par défaut » sont identifiés. Il s'agit des **états par défaut à la mise sous tension** lorsque l'instrument quitte l'usine.

Modes Continu, Enregistrement de données et Numérisation

Les modèles 34465A/70A peuvent fonctionner en mode Continu, Enregistrement de données ou Numérisation comme décrit ci-dessous.

REMARQUE Les multimètres numériques 34460A/61A fonctionnent toujours en mode Continu. Les modes Enregistrement de données et Numérisation ne sont pas disponibles sur ces modèles.

Mode Continu

Le mode Continu est le mode sélectionné par défaut sur tous les multimètres numériques Truevolt. Avec les réglages par défaut d'usine, le multimètre numérique effectue des mesures V CC avec les fonctions de commutation automatique de plage et de réglage du zéro automatique activées, le paramètre NPLC défini à 10 PLC, etc. (pour plus de détails, voir les réglages d'usine par défaut).

Mode Enregistrement de données

Le mode Enregistrement de données est disponible de série sur les modèles 34465A et 34470A et uniquement depuis le panneau avant du multimètre. Il inclut une interface utilisateur de panneau avant qui vous permet de configurer l'enregistrement des données dans la mémoire non volatile de l'instrument, ou dans des fichiers internes/externes, sans aucune programmation ni connexion à un ordinateur. Une fois la collecte de données terminée, vous pouvez visualiser ces dernières sur le panneau avant ou bien les transférer vers l'ordinateur. Le mode Enregistrement de données vous permet de spécifier un certain nombre de mesures, ou des mesures acquises sur une période donnée, dans la mémoire de l'instrument ou dans des fichiers de données internes ou externes.

Pour sélectionner le mode Enregistrement de données, appuyez sur **[Acquire] Acquire > Data Log**. Vous pouvez ensuite sélectionner l'intervalle d'échantillonnage (laps de temps s'écoulant entre les mesures, par exemple, 500 mS), la durée, sous forme de période ou de nombre de mesures, déterminer si l'enregistrement de données doit démarrer après un délai ou à une heure précise de la journée, et si les données doivent être enregistrées en mémoire ou dans des fichiers. Après avoir configuré les paramètres d'enregistrement des données, appuyez sur **[Run/Stop]**. L'enregistrement des données commencera après le délai spécifié ou à l'heure indiquée.

Mode Numérisation

Le mode numérisation concerne uniquement les modèles 34465A/70A équipés de l'option DIG et est uniquement disponible sur le panneau avant du multimètre numérique. Le mode numérisé fournit une interface utilisateur de panneau avant qui vous permet de configurer rapidement les mesures numérisées.

La numérisation est un processus consistant à convertir un signal analogique continu, par exemple une onde sinusoïdale en série d'échantillons discrets (lectures). La figure ci-dessous illustre le résultat de numérisation d'une onde sinusoïdale. Ce chapitre décrit les diverses méthodes de numérisation de signaux, l'importance de la fréquence d'échantillonnage et comment utiliser le déclenchement par niveau.

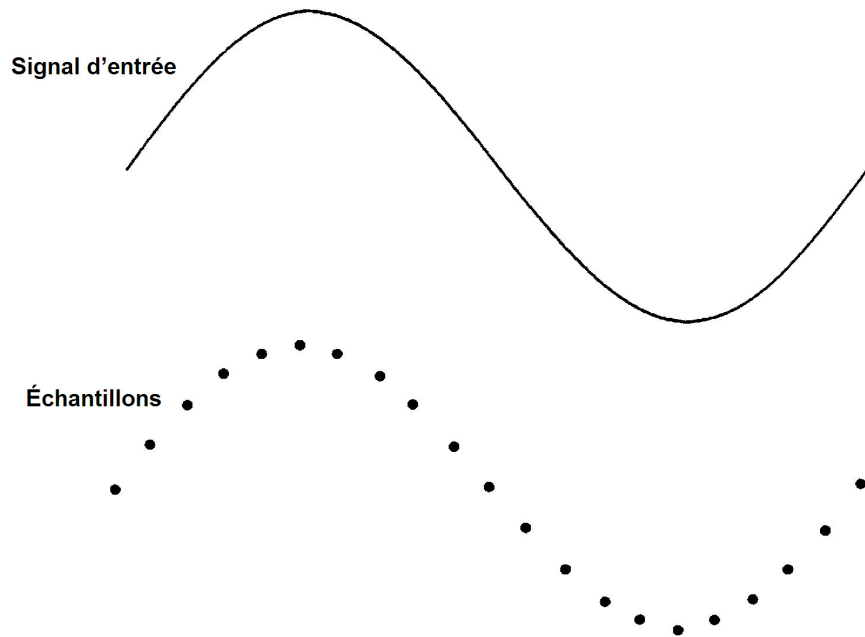

Paramètres par défaut des modes Enregistrement de données et Numérisation

Lors de l'accès au mode Enregistrement de données ou Numérisation, le multimètre numérique configure les paramètres suivants :

- Nombre de déclenchements défini à 1 (le nombre de déclenchements est généralement infini en mode Local et ne peut pas être réglé sur le panneau avant).
- Les mesures secondaires sont désactivées.
- La fonction mathématique de lissage est désactivée.
- Les statistiques sont effacées.
- L'histogramme est effacé.
- Le diagramme de tendance passe du mode périodisé Continu à un graphique de données simple.

Paramètres d'enregistrement de données par défaut supplémentaires

Lors de l'accès au mode Enregistrement de données, le multimètre numérique configure les paramètres suivants :

- La source de déclenchement est réglée sur Automatique.
- Le délai de déclenchement est réglé sur Automatique.
- Le nombre de pré-déclenchements est défini à zéro.
- Le nombre d'échantillons par déclenchement est défini en fonction de la durée d'enregistrement des données (temps ou échantillons).

Caractéristiques et fonctions

- Le temporisateur d'échantillonnage est placé en mode temporisateur (non immédiat) et la durée d'échantillonnage est définie en fonction de l'intervalle d'échantillonnage d'enregistrement des données.



Paramètres de numérisation par défaut supplémentaires



Lors de l'accès au mode Numérisation, le multimètre numérique configure les paramètres suivants :



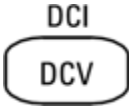



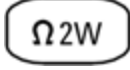

- Si la source de déclenchement est réglée sur Manuel, elle passe à Automatique. (Les paramètres Externe et Niveau ne changent pas.)
- Le mode Limites est désactivé.
- Le réglage d'échelle est désactivé.
- Les statistiques et l'histogramme sont placés en mode de post-traitement (calculés une fois la numérisation terminée).
- Une fois la fonction sélectionnée (V CC ou I CC) et pour la nouvelle fonction si celle-ci est modifiée :
 - La commutation automatique de plage est désactivée.
 - Le réglage automatique du zéro est désactivé.
 - Les paramètres NPLC et Ouverture sont définis à leurs valeurs minimales.
- Si la source de déclenchement est Externe ou Niveau, le nombre de pré-déclenchements est défini sur le paramètre de nombre de pré-déclenchements de numérisation (0 par défaut).
- Le nombre d'échantillons par déclenchement est défini en fonction de la durée de numérisation (temps ou échantillons).
- Le temporisateur d'échantillonnage est placé en mode temporisateur (non immédiat) et réglé en fonction de l'intervalle d'échantillonnage d'enregistrement des données.
- Le mode Diagramme de tendance passe au mode périodisé lors de l'enregistrement de données dans un fichier.
- Lors du retour au mode Continu, les réglages sont laissés tels quels en mode Enregistrement de données ou Numérisation, à l'exception de ce qui suit :
 - La source d'échantillonnage est réglée sur Immédiate.
 - Le nombre de pré-déclenchements est défini à 0.
 - Le nombre d'échantillons par déclenchement est défini à 1.
 - Le nombre de déclenchements est réglé sur Infini.

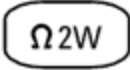

Aide-mémoire des menus du panneau avant



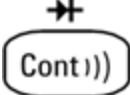
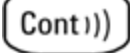

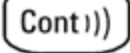













Le tableau suivant récapitule les touches du panneau avant et la structure de menus.

Touche	Objet
	<p>Configurer les mesures en tension continue, notamment les mesures du rapport de tension continue :</p> <p>Plage : Commutation automatique de plage (valeur par défaut), 100 mV, 1 V, 10 V, 100 V ou 750 V</p> <p>Ouverture NPLC : 0,02 ; 0,2 ; 1 ; 10 ; 100. Valeur par défaut : 10 (34460A/61A) 0,02 ; 0,06 ; 0,2 ; 1 ; 10 ; 100. Valeur par défaut : 10 (34465A/70A sans option DIG) 0,001 ; 0,002 ; 0,006 ; 0,02 ; 0,06 ; 0,2 ; 1 ; 10 ; 100. Valeur par défaut : 10 (34465A/70A avec l'option DIG)</p> <p>Pour de plus amples informations, reportez-vous à la section Plage, résolution et NPLC.</p> <p>Temps d'ouverture (concerne uniquement les modèles 34465A et 34470A) : (Sans l'option DIG) 200 µs à 1 s (résolution de 2 µs), valeur par défaut : 100 ms. (Avec l'option DIG) 20 µs à 1 s (résolution de 2 µs), valeur par défaut : 100 ms.</p> <p>Réglage automatique du zéro : Désactivé ou Activé (valeur par défaut)</p> <p>Entrée Z : 10 MΩ (valeur par défaut) ou HighZ (<1 GΩ)</p> <p>Rapport de tension continu : Désactivé (par défaut) ou Activé</p>
	<p>Configurer les mesures en courant continu :</p> <p>Bornes : 3 A ou 10 A</p> <p>Plage : Auto, 100 µA, 1 mA, 10 mA, 100 mA, 1 A, 3 A ou 10 A (lorsque les bornes sont réglées sur 10 A). Les modèles 34465A et 34470A comportent des plages de courant continu de 1 µA et 10 µA.</p> <p>Ouverture NPLC : 0,02 ; 0,2 ; 1 ; 10 ; 100. Valeur par défaut : 10 (34460A/61A) 0,02 ; 0,06 ; 0,2 ; 1 ; 10 ; 100. Valeur par défaut : 10 (34465A/70A sans option DIG) 0,001 ; 0,002 ; 0,006 ; 0,02 ; 0,06 ; 0,2 ; 1 ; 10 ; 100. Valeur par défaut : 10 (34465A/70A avec l'option DIG)</p> <p>Pour de plus amples informations, reportez-vous à la section Plage, résolution et NPLC.</p> <p>Temps d'ouverture (concerne uniquement les modèles 34465A et 34470A) : (Sans l'option DIG) 200 µs à 1 s (résolution de 2 µs), valeur par défaut : 100 ms. (Avec l'option DIG) 20 µs à 1 s (résolution de 2 µs), valeur par défaut : 100 ms.</p> <p>Réglage automatique du zéro : Désactivé ou Activé (valeur par défaut)</p>
	<p>Configurer les mesures en tension alternative :</p> <p>Plage : Commutation automatique de plage (valeur par défaut), 100 mV, 1 V, 10 V, 100 V ou 750 V</p> <p>Filtre : >3 Hz, >20 Hz, >200 Hz</p>



Touche	Objet
 	<p>Configurer les mesures en courant alternatif :</p> <p>Bornes : 3 A ou 10 A</p> <p>Plage : Auto, 100 μA, 1 mA, 10 mA, 100 mA, 1 A, 3 A ou 10 A (lorsque les bornes sont réglées sur 10 A)</p> <p>Filtre : >3 Hz, >20 Hz, >200 Hz</p>
 	<p>Configurer les mesures de résistance en 2 fils :</p> <p>Plage : 100 Ω, 1 kΩ, 10 kΩ, 100 kΩ, 1 MΩ, 10 MΩ, 100 MΩ, 1 GΩ (34465A et 34470A uniquement) ou Auto (valeur par défaut). Remarque : Le courant approximatif généré pour chaque plage (par exemple, \sim1 mA) est indiqué sur la touche de fonction respective.</p> <p>Ouverture NPLC : 0,02 ; 0,2 ; 1 ; 10 ; 100. Valeur par défaut : 10 (34460A/61A) 0,02 ; 0,06 ; 0,2 ; 1 ; 10 ; 100. Valeur par défaut : 10 (34465A/70A sans option DIG) 0,001 ; 0,002 ; 0,006 ; 0,02 ; 0,06 ; 0,2 ; 1 ; 10 ; 100. Valeur par défaut : 10 (34465A/70A avec l'option DIG)</p> <p>Pour de plus amples informations, reportez-vous à la section Plage, résolution et NPLC.</p> <p>Temps d'ouverture (concerne uniquement les modèles 34465A et 34470A) : (Sans l'option DIG) 200 μs à 1 s (résolution de 2 μs), valeur par défaut : 100 ms. (Avec l'option DIG) 20 μs à 1 s (résolution de 2 μs), valeur par défaut : 100 ms.</p> <p>Réglage automatique du zéro : Désactivé ou Activé (valeur par défaut)</p> <p>OffstComp : OFF (valeur par défaut) ou ON. Concerne uniquement les modèles 34465A et 34470A.</p> <p>Low Power : Désactive (Off) ou active (On) les mesures de basse puissance. Concerne uniquement les modèles 34465A et 34470A.</p>

Touche	Objet
  	<p>Configurer les mesures de résistance en 4 fils :</p> <p>Plage : 100 Ω, 1 kΩ, 10 kΩ, 100 kΩ, 1 MΩ, 10 MΩ, 100 MΩ, 1 GΩ (34465A et 34470A uniquement) ou Auto (valeur par défaut). Remarque : Le courant approximatif généré pour chaque plage (par exemple, ~1 mA) est indiqué sur la touche de fonction respective.</p> <p>Ouverture NPLC : 0,02 ; 0,2 ; 1 ; 10 ; 100. Valeur par défaut : 10 (34460A/61A) 0,02 ; 0,06 ; 0,2 ; 1 ; 10 ; 100. Valeur par défaut : 10 (34465A/70A sans option DIG) 0,001 ; 0,002 ; 0,006 ; 0,02 ; 0,06 ; 0,2 ; 1 ; 10 ; 100. Valeur par défaut : 10 (34465A/70A avec l'option DIG)</p> <p>Pour de plus amples informations, reportez-vous à la section Plage, résolution et NPLC.</p> <p>Temps d'ouverture (concerne uniquement les modèles 34465A et 34470A) : (Sans l'option DIG) 200 μs à 1 s (résolution de 2 μs), valeur par défaut : 100 ms. (Avec l'option DIG) 20 μs à 1 s (résolution de 2 μs), valeur par défaut : 100 ms.</p> <p>OffstComp : OFF (valeur par défaut) ou ON. Concerne uniquement les modèles 34465A et 34470A.</p> <p>Low Power : Désactive (Off) ou active (On) les mesures de basse puissance. Concerne uniquement les modèles 34465A et 34470A.</p>
	<p>Configurer les mesures de fréquence et de période. Les paramètres incluent la plage, le filtre de courant alternatif et le temps de porte.</p> <p>Plage : 100 mV, 1 V, 10 V, 100 V, 750 V, Auto (valeur par défaut)</p> <p>Filtre : >3 Hz, >20 Hz, >200 Hz</p> <p>Temps de porte : 10 ms, 100 ms (par défaut) ou 1 s</p> <p>Temporisation : 1 s (valeur par défaut) ou Auto</p>
  	<p>Configurer les mesures de capacité :</p> <p>Plage : 1 nF, 10 nF, 100 nF, 1 μF, 10 μF, 100 μF or Auto (valeur par défaut)</p>
 	<p>Configurer les mesures de continuité :</p> <p>Avertisseur sonore : Désactivé ou Activé (valeur par défaut)</p>
  	<p>Configurer les mesures de diode :</p> <p>Avertisseur sonore : Désactivé ou Activé (valeur par défaut)</p>

Touche	Objet
	<p>Configurer les mesures de température en 2 et 4 fils.</p> <p>Paramètres de sonde : RTD 2 fils, RTD 4 fils (paramètre par défaut), Thermistance 2 fils, Thermistance 4 fils, TCouple (modèles 34465A/70A uniquement)</p> <p>Paramètres supplémentaires pour le type de sonde RTD 2 fils ou RTD 4 fils :</p> <ul style="list-style-type: none"> • R0 : R_0 correspond à la résistance nominale d'un RTD à 0 °C. 100 Ω par défaut • Low Power : Désactive (Off) ou active (On) les mesures de basse puissance. Concerne uniquement les modèles 34465A et 34470A. <p>Paramètres supplémentaires pour le type de sonde Thermistance 2 fils ou Thermistance 4 fils :</p> <ul style="list-style-type: none"> • Low Power : Désactive (Off) ou active (On) les mesures de basse puissance. Concerne uniquement les modèles 34465A et 34470A. <p>Paramètres supplémentaires pour le type de sonde TCouple :</p> <ul style="list-style-type: none"> • Type : J (valeur par défaut), K, E, T, N ou R • Référence : Interne ou Fixe • Réglage du décalage : (Disponible pour une référence interne uniquement). -20 °C à +20 °C. Valeur par défaut : 0 °C. • Décalage fixe : (Disponible pour une référence fixe uniquement). -20 °C à +80 °C. Valeur par défaut : 0 °C. <p>Ouverture NPLC : 0,02 ; 0,2 ; 1 ; 10 ; 100. Valeur par défaut : 10 (34460A/61A) 0,02 ; 0,06 ; 0,2 ; 1 ; 10 ; 100. Valeur par défaut : 10 (34465A/70A sans option DIG) 0,001 ; 0,002 ; 0,006 ; 0,02 ; 0,06 ; 0,2 ; 1 ; 10 ; 100. Valeur par défaut : 10 (34465A/70A avec l'option DIG)</p> <p>Pour de plus amples informations, reportez-vous à la section Plage, résolution et NPLC.</p> <p>Temps d'ouverture (concerne uniquement les modèles 34465A et 34470A) : (Sans l'option DIG) 200 μs à 1 s (résolution de 2 μs), valeur par défaut : 100 ms. (Avec l'option DIG) 20 μs à 1 s (résolution de 2 μs), valeur par défaut : 100 ms.</p> <p>Réglage automatique du zéro : Désactivé ou Activé (valeur par défaut) (Mesures en 2 fils seulement ; non disponible pour les mesures en 4 fils)</p> <p>OffstComp : OFF (valeur par défaut) ou ON. (Mesures de RTD en 2 et 4 fils seulement)</p> <p>Vérification d'ouverture : Mesures TCouple uniquement.*</p> <p>Unités : °C, °F ou K</p>
	<p>Lancer et arrêter des mesures.</p>

Touche	Objet
 	Réinitialiser l'instrument pour une utilisation du panneau avant ; équivalent à la commande SYST:PRESet .
	Effectuer une mesure unique.
 	Effectuer une ou plusieurs mesures mains libres.
	Effectuer une mesure par rapport à une valeur de référence.
 	Configurer la fonction de mesure par rapport à une référence, le filtre de lissage (concerne uniquement les modèles 34465A et 34470A), le réglage d'échelle, les statistiques et les limites.
	Configurer le texte et les graphiques qui apparaissent à l'écran et les mesures secondaires.
 	Sauvegarder et rappeler des configurations et des préférences de l'instrument. Configurer les interfaces d'E/S : LAN (en option sur 34460A), USB, GPIB (en option). Effectuer des tâches d'administration système, notamment l'étalonnage. Configurer les préférences de l'utilisateur. Effectuer des opérations de gestion des fichiers, notamment la création de « captures d'écran » (images d'écran).
 	Obtenir des informations supplémentaires sur l'instrument, savoir comment télécharger ou consulter la documentation, consulter le dernier message d'erreur ou effacer des messages d'erreur.
 	Effectuer un étalonnage automatique (34465A/70A uniquement).
	Sélectionner la commutation de plage manuelle ou automatique. Appuyez sur  pour monter manuellement d'une plage ou sur  pour descendre manuellement d'une plage.

Caractéristiques et fonctions

Touche	Objet
 <p>Shift Local</p>	<p>Retourner au mode de commande local de l'instrument (en mode de commande à distance) ou indiquer que la touche suivante du panneau avant sera « basculée », par exemple [Probe Hold] à la place de [Single].</p> <p>Probe Hold</p> 

Les touches qui accèdent à un large éventail de fonctions sont répertoriées ci-dessous.

Touche [Acquire] (Acquisition)



Touche de fonction	Description
Acquire	Sélectionner le mode Continu (mode de mesure par défaut), le mode Numérisation ou le mode Enregistrement de données.*
Trigger Settings	Configurer le déclenchement.
VMC Out	Régler la pente de sortie VM Comp (Mesure terminée).
Save Readings	Enregistrer les lectures dans un fichier.

* Les modes Numérisation et Enregistrement de données sont uniquement disponibles sur les modèles 34465A/70A. Le mode Numérisation requiert l'option DIG.

Touche [Math] (Opération mathématique)



La disponibilité des touches de fonction Math varie selon la fonction de mesure.

Touche de fonction	Description
Null	Activer/désactiver l'utilisation de valeurs de référence et spécifier la valeur de référence à utiliser.
Smoothing Filter	(34465A/70A uniquement) La fonction de lissage est un filtre à moyenne flottante (boxcar) qui permet de réduire le bruit aléatoire dans les mesures. Elle vise à calculer la moyenne des variations mineures observées dans les mesures. Les variations plus importantes provoquent une réinitialisation du filtre.
dB / dBm	(modèles 34460A/61A uniquement) Configurer dB, dBm
Scaling	(modèles 34465A/70A uniquement) Configurer le réglage d'échelle : dB, dBm, %, Mx B
Statistics	Activer, désactiver et supprimer des statistiques.
Limits	Activer ou désactiver les limites supérieure et inférieure.

Touche [Display] (Affichage)



Caractéristiques et fonctions

Touche de fonction	Description
Display	Choisir l'élément affiché : nombre, barre de mesure, histogramme ou diagramme de tendance (34461A/65A/70A uniquement).
Label	Activer ou désactiver l'affichage d'un message.
Label Text	Modifier le texte qui s'affiche lorsque la touche de fonction Label est activée.
2nd Meas	Sélectionner une mesure secondaire.
Digit Mask	Définir le nombre de chiffres affichés pour les mesures.

Touche [Utility] (Utilitaire)



Touche de fonction	Description
Store/Recall	Sauvegarder et rappeler des fichiers de configuration et de préférences, et définir les réglages par défaut à la mise sous tension.
Manage Files	Effectuer des tâches de gestion de fichiers de base et créer des captures d'écran.
I/O Config	Configurer les interfaces du réseau local (en option sur le modèle 34460A), USB et GPIB (en option).
Test/Admin	Effectuer des tâches d'autotest, d'étalonnage, de gestion de la sécurité et de la licence, et de mise à jour du microprogramme.
System Setup	Définir les préférences de l'utilisateur, la date et l'heure et le message qui s'affiche à la mise sous tension.

Mesures

Les multimètres numériques Keysight Truevolt prennent en charge de nombreuses mesures courantes :

Tension continue

Tension alternative

Courant continu

Courant alternatif

Résistance

Température

Capacité

Continuité

Diode

Fréquence et période

Enregistrement de données

Numérisation

Déclenchement par niveau

Tension continue

Cette section décrit la procédure à suivre pour configurer les mesures en tension continue depuis le panneau avant, et notamment les mesures du rapport de tension continue.

Étape 1 : Configurez les cordons de test comme indiqué.

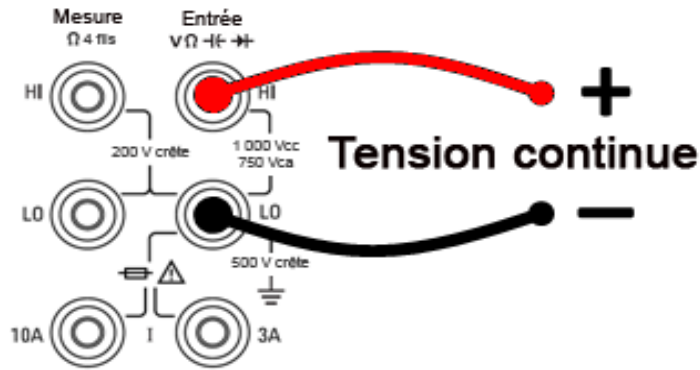

Étape 2 : Appuyez sur la touche [DCV] du panneau avant.

Étape 3 :

- **Pour les modèles 34460A/61A**, appuyez sur **Aperture** et choisissez le nombre de cycles de tension d'alimentation (PLC) souhaités pour la mesure. Seuls 1, 10 et 100 PLC permettent une réjection (du bruit de fréquence réseau) en mode normal. La sélection de 100 PLC permet une réjection de bruit et une résolution optimales, mais ralentit les mesures.

Range Auto	Aperture 10 PLC	Auto Zero Off On	Input Z 10M Auto	DCV Ratio Off On
----------------------	---------------------------	----------------------------	----------------------------	----------------------------

Select # of Power Line Cycles				
100 PLC	10 PLC	1 PLC	0.2 PLC	0.02 PLC

- Pour les modèles 34465A/70A, la touche de fonction **Aperture NPLC** est sélectionnée par défaut. Utilisez les touches fléchées vers le haut/bas pour spécifier le temps d'intégration en nombre de cycles de tension d'alimentation (PLC) souhaités pour la mesure. 1, 10 et 100 PLC permettent une réjection (du bruit de fréquence réseau) en mode normal. La sélection de 100 PLC permet une réjection de bruit et une résolution optimales, mais ralentit les mesures.

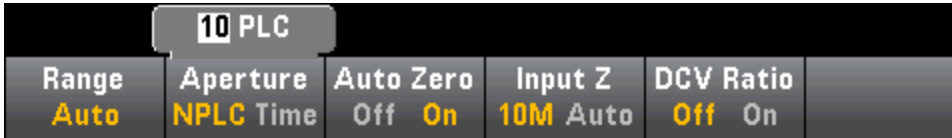

Pour définir le temps d'intégration avec précision, au lieu d'utiliser des PLC, appuyez sur **Aperture Time** et utilisez les touches fléchées vers la gauche/droite et vers le haut/bas pour spécifier le temps d'intégration en secondes. Pour **Aperture Time**, vous pouvez spécifier un temps d'intégration compris entre 200 μ s (20 μ s avec l'option DIG) et 1 s (résolution de 2 μ s) :

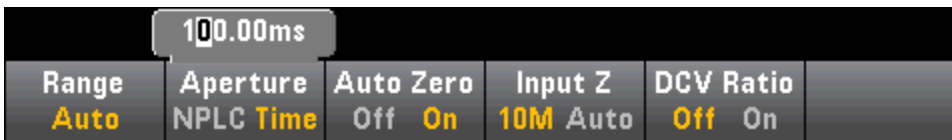

Étape 4 : Appuyez sur **Range** et sélectionnez une plage pour la mesure. Vous pouvez également sélectionner la plage à l'aide des touches [+], [-] et [**Range**] du panneau avant. La fonction de commutation automatique de plage (**Auto**) sélectionne automatiquement la plage de la mesure en fonction de l'entrée. Cette fonction est pratique, mais génère des mesures plus lentes par rapport à la fonction de commutation manuelle. Elle augmente d'une plage à 120 % de la plage actuelle et descend d'une plage sous 10 % de la plage actuelle.



Étape 5 : Auto Zero : La fonction de réglage automatique du zéro permet d'obtenir des mesures de haute précision, mais exige plus de temps pour effectuer la mesure du zéro. Lorsque la fonction de réglage automatique du zéro est activée, le multimètre mesure en interne le décalage après chaque mesure. Elle soustrait ensuite cette mesure de la lecture précédente. Cette méthode évite que des tensions de décalage présentes sur le circuit d'entrée de l'instrument n'affectent la précision de mesure. Lorsque cette fonction est désactivée (OFF), le multimètre mesure le décalage une fois et soustrait ce dernier de toutes les mesures suivantes. Il recueille une nouvelle mesure du décalage chaque fois que vous modifiez la fonction, la plage ou le temps d'intégration. (Il n'existe aucun réglage du zéro automatique pour les mesures de résistance en 4 fils.)

Étape 6 : Spécifiez l'impédance d'entrée pour les cordons de test (**Input Z**). Ce paramètre spécifie l'impédance d'entrée de la borne de mesure, qui est Auto ou 10 M Ω . Le mode Auto sélectionne une impédance élevée (HighZ) pour les plages 100 mV, 1 V et 10 V, et 10 M Ω pour les plages 100 V et 1 000 V. Dans la plupart des cas, la valeur 10 M Ω est suffisamment élevée pour ne pas charger la plupart des circuits. Cependant, elle n'est pas suffisamment basse pour stabiliser les lectures des circuits à impédance

élevée. Cette valeur engendre également des lectures comportant moins de bruit qu'avec l'option **HighZ**, qui est prévue pour les situations dans lesquelles la charge de 10 M Ω est importante.

Rapport de tension continue

La touche **DCV Ratio** permet d'activer ou de désactiver la mesure du rapport de tension continue. Notez que la touche de fonction **Auto Zero** disparaît lorsque vous activez les mesures du rapport de tension continue. En effet, le réglage automatique du zéro ne peut pas être désactivé pendant la mesure du rapport de tension continue.

Le rapport est la tension aux bornes d'entrée, divisée par la tension de référence. La tension de référence est la différence de deux mesures distinctes. Ces mesures correspondent aux tensions continues entre la borne de mesure HI et la borne d'entrée LO, et entre la borne de mesure LO et la borne d'entrée LO. Ces deux mesures doivent être comprises dans la plage ± 12 Vcc. La tension de référence est toujours en commutation automatique de plage, et la plage utilisée pour les deux est basée sur le plus grand résultat de ces deux mesures.

Configurez les mesures du rapport de tension continue comme indiqué ci-dessous :

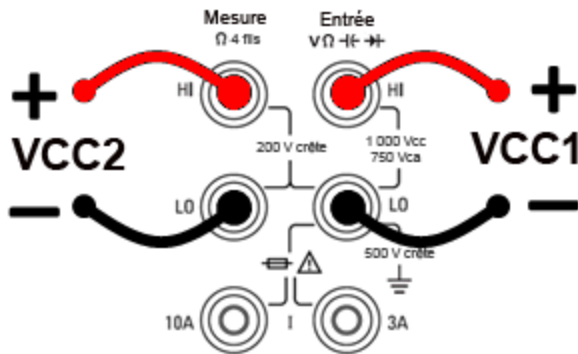

Tension alternative

Cette section décrit la procédure à suivre pour configurer les mesures en tension alternative depuis le panneau avant.

REMARQUE Les délais par défaut sont sélectionnés pour fournir les premières lectures correctes de la plupart des mesures. Pour des mesures de haute précision, la constante de temps RC de blocage de l'entrée doit être stabilisée à 1/50 du niveau de signal alternatif.

Les signaux supérieurs à 300 V (eff.) ou à 1 A (eff.) provoqueront l'auto-échauffement des composants de conditionnement de signaux. Ces erreurs sont incluses dans les spécifications de l'instrument. Des variations de température internes dues à un effet d'auto-échauffement peuvent provoquer des erreurs supplémentaires sur d'autres fonctions ou plages. Ces erreurs disparaissent généralement après quelques minutes.

Par exemple, supposons un signal de 100 mVca avec une polarisation de 10 Vcc. La polarisation de 10 Vcc doit être stabilisée à 1/50 de 100 mVca ou 2 mVcc. Le temps de stabilisation correspondant peut être calculé à l'aide de la constante de temps RC de blocage de 0,22 s comme suit :

$$\text{temps de stabilisation} = \ln(\text{polarisation/valeur stabilisée}) * 0,22 \text{ s}$$

$$\text{temps de stabilisation} = \ln(10 \text{ Vcc} / 2 \text{ mVcc}) * 0,22 \text{ s}$$

$$\text{temps de stabilisation} = \ln(5\,000) * 0,22 \text{ s} = 1,9 \text{ s}$$

Ce délai de stabilisation supplémentaire doit être appliqué après avoir connecté le signal à l'entrée V CA du multimètre numérique ou après avoir sélectionné la fonction V CA avec le signal déjà connecté. Si la polarisation en courant continu demeure constante, les mesures suivantes peuvent être réalisées avec une précision absolue sans retards de stabilisation supplémentaires.

Étape 1 : Configurez les cordons de test comme indiqué.

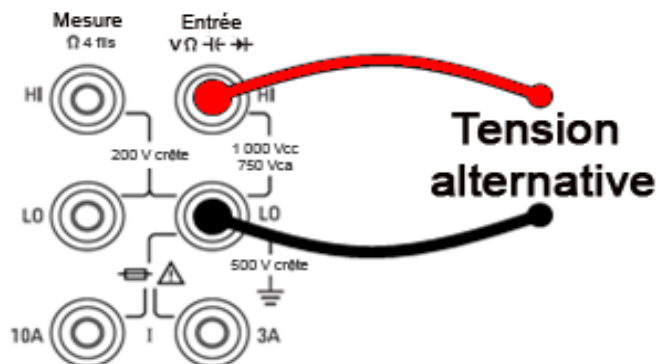

Étape 2 : Appuyez sur la touche [ACV] du panneau avant.

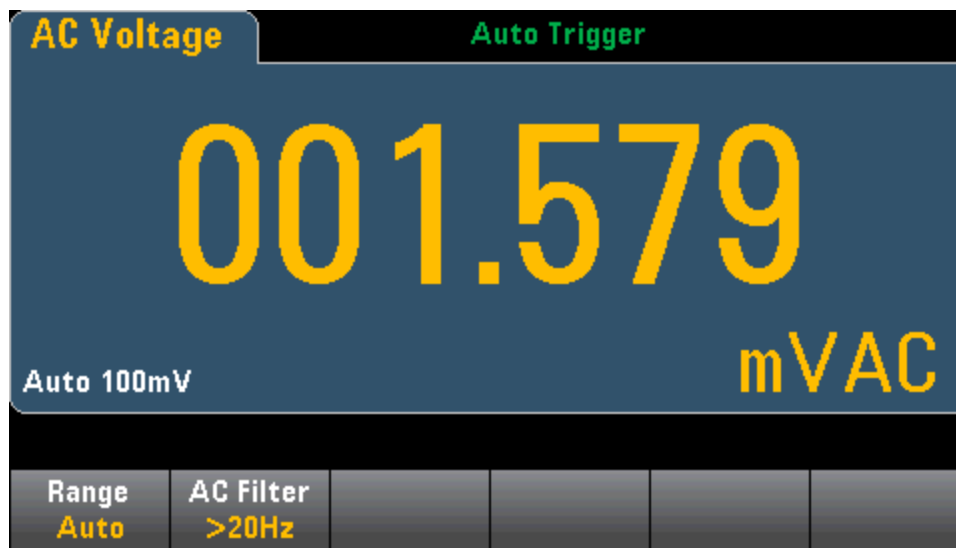

Étape 3 : Appuyez sur **Range** et sélectionnez une plage pour la mesure. La fonction de commutation automatique de plage (**Auto**) sélectionne automatiquement la plage de la mesure en fonction de l'entrée. Cette fonction est pratique, mais génère des mesures plus lentes par rapport à la fonction de commutation manuelle. Elle augmente d'une plage à 120 % de la plage actuelle et descend d'une plage sous 10 % de la plage actuelle.

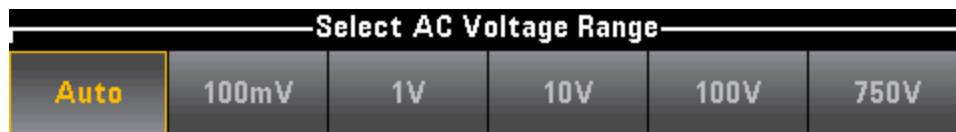

Étape 4 : Appuyez sur **AC Filter** et choisissez le filtre pour la mesure. L'instrument utilise trois filtres de courant alternatif différents qui vous permettent d'optimiser la précision en basse fréquence ou de réduire les temps de stabilisation en courant alternatif suite à une variation de l'amplitude du signal d'entrée.

Les trois filtres sont 3 Hz, 20 Hz et 200 Hz et vous devez généralement sélectionner le filtre à plus haute fréquence dont la fréquence est inférieure au signal que vous mesurez, car les filtres à fréquence plus élevée génèrent des mesures plus rapides. Par exemple, lors de la mesure d'un signal compris entre 20 et 200 Hz, utilisez le filtre 20 Hz.

Si la vitesse de mesure n'est pas un problème, un filtre à plus basse fréquence peut produire des mesures plus silencieuses, selon le signal que vous mesurez.



REMARQUE Pour un affichage précis des statistiques des mesures en courant alternatif en mode Panneau avant, vous devez utiliser le retard de déclenchement manuel par défaut (**[Acquire] > Delay Man**).

Courant continu

MISE EN GARDE Ne pas dépasser le courant nominal maximum pour la mesure du courant continu. Tout dépassement du courant nominal maximal peut faire griller un fusible.

Cette section décrit la procédure de configuration des mesures en courant continu à partir du panneau avant.

Étape 1 : Configurez les cordons de test comme indiqué.

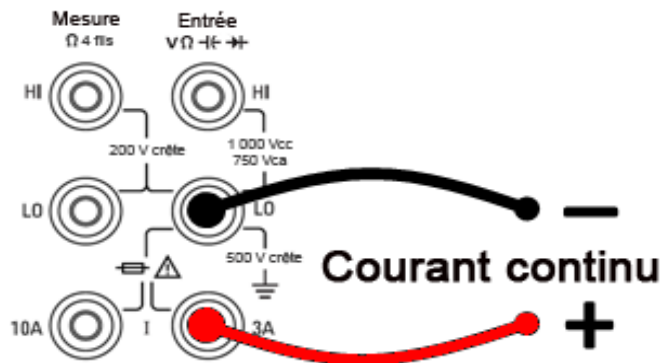

Sur les modèles 34461A/65A/70A, vous pouvez également configurer la mesure avec la borne de 10 A, qui est recommandée pour mesurer un courant supérieur à 1 A :

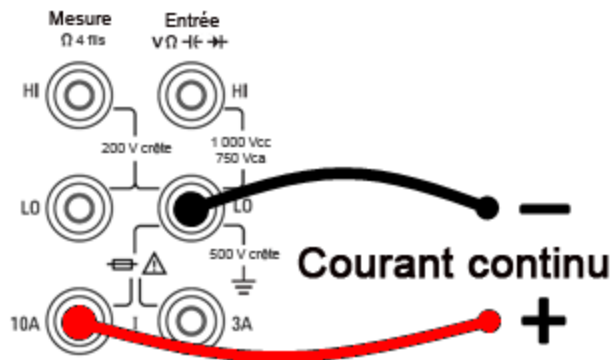

Étape 2 : Appuyez sur la touche [DCI] du panneau avant.



Étape 3 : Pour les modèles 34465A/70A, la touche de fonction **Aperture NPLC** est sélectionnée par défaut. Utilisez les touches fléchées vers le haut/bas pour spécifier le temps d'intégration en nombre de cycles de tension d'alimentation (PLC) souhaités pour la mesure. 1, 10 et 100 PLC permettent une

réjection (du bruit de fréquence réseau) en mode normal. La sélection de 100 PLC permet une réjection de bruit et une résolution optimales, mais ralentit les mesures.

Étape 4 (34461A/65A/70A uniquement): Les bornes de 3A sont sélectionnées par défaut. La touche de fonction **Terminals** bascule entre les bornes de 3 A et les bornes d'entrée de 10 A. Si vous modifiez ce paramètre à 10 A, la plage de mesure devient automatiquement 10 A.

Étape 5 : Appuyez sur **Range** et sélectionnez une plage pour la mesure. Vous pouvez également sélectionner la plage à l'aide des touches [+], [-] et [**Range**] du panneau avant. La fonction de commutation automatique de plage (**Auto**) sélectionne automatiquement la plage de la mesure en fonction de l'entrée. Cette fonction est pratique, mais génère des mesures plus lentes par rapport à la fonction de commutation manuelle. Elle augmente d'une plage à 120 % de la plage actuelle et descend d'une plage sous 10 % de la plage actuelle. Appuyez sur **More** pour basculer entre les deux pages de paramètres.

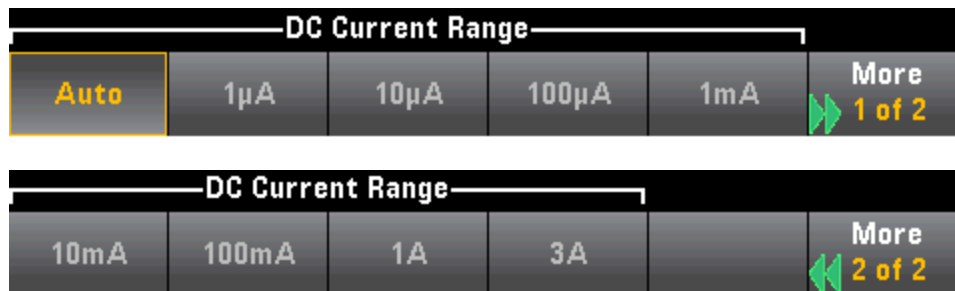

Étape 6 : Auto Zero : La fonction de réglage automatique du zéro permet d'obtenir des mesures de haute précision, mais exige plus de temps pour effectuer la mesure du zéro. Lorsque la fonction de réglage automatique du zéro est activée, le multimètre mesure en interne le décalage après chaque mesure. Elle soustrait ensuite cette mesure de la lecture précédente. Cette méthode évite que des tensions de décalage présentes sur le circuit d'entrée de l'instrument n'affectent la précision de mesure. Lorsque cette fonction est désactivée (OFF), le multimètre mesure le décalage une fois et soustrait ce dernier de toutes les mesures suivantes. Il recueille une nouvelle mesure du décalage chaque fois que vous modifiez la fonction, la plage ou le temps d'intégration. (Il n'existe aucun réglage du zéro automatique pour les mesures de résistance en 4 fils.)

Courant alternatif

MISE EN GARDE Ne pas dépasser le courant nominal maximum pour la mesure du courant alternatif. Tout dépassement du courant nominal maximal peut faire griller un fusible.

Cette section décrit la procédure de configuration des mesures en courant alternatif à partir du panneau avant.

Étape 1 : Configurez les cordons de test comme indiqué.

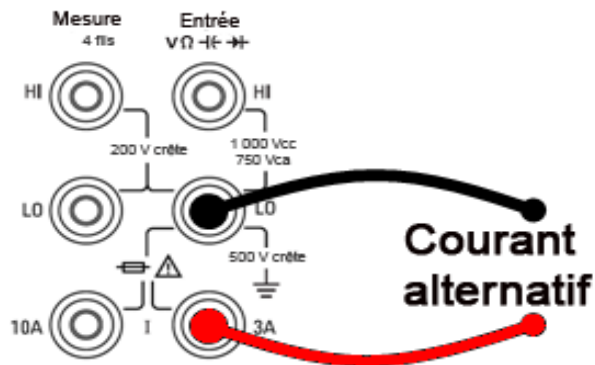

Sur les modèles 34461A/65A/70A, vous pouvez également configurer la mesure avec la borne de 10 A, qui est recommandée pour mesurer un courant supérieur à 1 A :

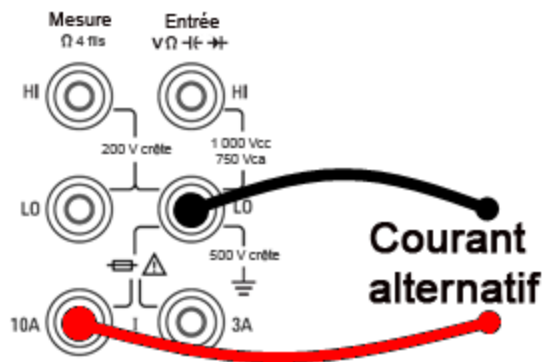

Étape 2 : Appuyez sur la touche [ACI] du panneau avant.

Terminals 3A 10A	Range Auto	AC Filter >20Hz			
----------------------------	----------------------	------------------------------	--	--	--

Étape 3 (34461A/65A/70A uniquement): Les bornes de 3A sont sélectionnées par défaut. La touche de fonction **Terminals** bascule entre les bornes de 3 A et les bornes d'entrée de 10 A. Si vous modifiez ce paramètre à 10 A, la plage de mesure devient automatiquement 10 A.

MISE EN GARDE Lors de la réalisation de mesures à l'aide de bornes 10 A, la présence d'un signal sur les bornes 3A peut provoquer de graves erreurs.

Étape 4 : Appuyez sur **Range** et sélectionnez une plage pour la mesure. Vous pouvez également sélectionner la plage à l'aide des touches **[+]**, **[-]** et **[Range]** du panneau avant. La fonction de commutation automatique de plage (**Auto**) sélectionne automatiquement la plage de la mesure en fonction de l'entrée. Cette fonction est pratique, mais génère des mesures plus lentes par rapport à la fonction de commutation manuelle. Elle augmente d'une plage à 120 % de la plage actuelle et descend d'une plage sous 10 % de la plage actuelle. Appuyez sur **More** pour basculer entre les deux pages de paramètres.

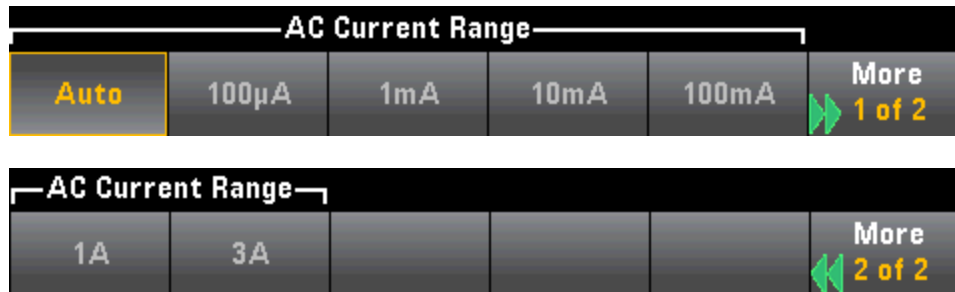

Étape 5 : Appuyez sur **AC Filter** et choisissez le filtre pour la mesure. L'instrument utilise trois filtres de courant alternatif différents qui vous permettent d'optimiser la précision en basse fréquence ou de réduire les temps de stabilisation en courant alternatif suite à une variation de l'amplitude du signal d'entrée.

Les trois filtres sont 3 Hz, 20 Hz et 200 Hz et vous devez généralement sélectionner le filtre à plus haute fréquence dont la fréquence est inférieure au signal que vous mesurez, car les filtres à fréquence plus élevée génèrent des mesures plus rapides. Par exemple, lors de la mesure d'un signal compris entre 20 et 200 Hz, utilisez le filtre 20 Hz.

Si la vitesse de mesure n'est pas un problème, un filtre à plus basse fréquence peut produire des mesures plus silencieuses, selon le signal que vous mesurez.



REMARQUE Pour un affichage précis des statistiques des mesures en courant alternatif en mode Panneau avant, vous devez utiliser le retard de déclenchement manuel par défaut (**[Acquire]** > **Delay Man**).

Résistance

Cette section décrit la procédure à suivre pour configurer les mesures de résistance en 2 ou 4 fils depuis le panneau avant.

Étape 1 : Configurez les cordons de test comme indiqué.

Résistance 2 fils :

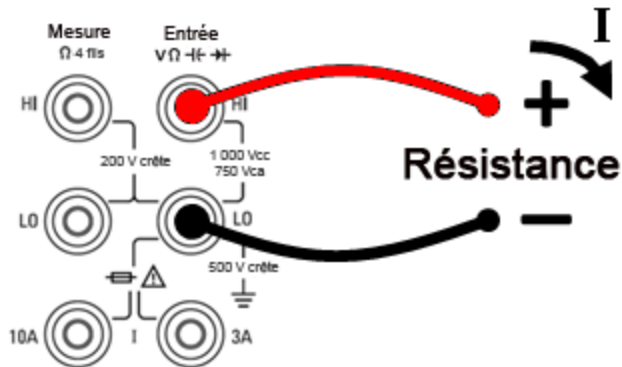

Résistance 4 fils :

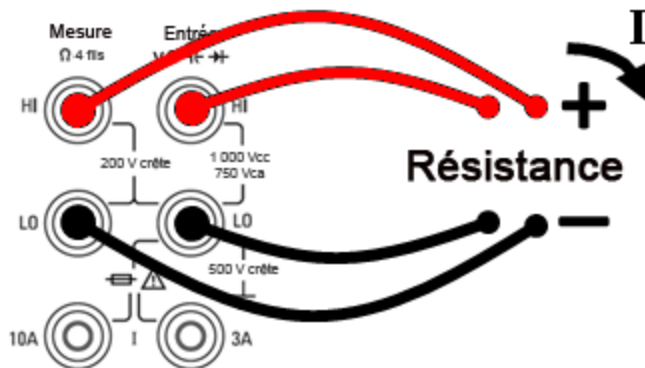

Étape 2 : Appuyez sur la touche [$\Omega 2W$] ou [$\Omega 4W$] du panneau avant. Le menu suivant s'affiche. (Le menu $\Omega 4W$ n'inclut pas la touche **Auto Zero**.)

10 PLC					
Range	Aperture	Auto Zero	OffstComp	Low Power	
Auto	NPLC Time	Off On	Off On	Off On	

Étape 3 : Pour les modèles 34465A/70A, la touche de fonction **Aperture NPLC** est sélectionnée par défaut. Utilisez les touches fléchées vers le haut/bas pour spécifier le temps d'intégration en nombre de cycles de tension d'alimentation (PLC) souhaités pour la mesure. 1, 10 et 100 PLC permettent une réjection (du bruit de fréquence réseau) en mode normal. La sélection de 100 PLC permet une réjection de bruit et une résolution optimales, mais ralentit les mesures.

Étape 4 : Appuyez sur **Range** et sélectionnez une plage pour la mesure. La fonction de commutation automatique de plage (**Auto**) sélectionne automatiquement la plage de la mesure en fonction de l'entrée. Cette fonction est pratique, mais génère des mesures plus lentes par rapport à la fonction de commutation manuelle. Elle augmente d'une plage à 120 % de la plage actuelle et descend d'une plage sous 10 % de la plage actuelle. Appuyez sur **More** pour basculer entre les deux pages de paramètres.



Notez que la quantité de courant de test générée est indiquée pour chaque plage. Après avoir sélectionné une plage, le menu de résistance principal est affiché.



Étape 5 : Auto Zero : La fonction de réglage automatique du zéro permet d'obtenir des mesures de haute précision, mais exige plus de temps pour effectuer la mesure du zéro. Lorsque la fonction de réglage automatique du zéro est activée, le multimètre mesure en interne le décalage après chaque mesure. Elle soustrait ensuite cette mesure de la lecture précédente. Cette méthode évite que des tensions de décalage présentes sur le circuit d'entrée de l'instrument n'affectent la précision de mesure. Lorsque cette fonction est désactivée (OFF), le multimètre mesure le décalage une fois et soustrait ce dernier de toutes les mesures suivantes. Il recueille une nouvelle mesure du décalage chaque fois que vous modifiez la fonction, la plage ou le temps d'intégration. (Il n'existe aucun réglage du zéro automatique pour les mesures de résistance en 4 fils.)

Étape 6 : OffstComp (modèles 34465A/70A uniquement) : Active ou désactive la compensation de décalage. La compensation de décalage élimine les effets de faibles tensions continues dans le circuit mesuré. La méthode consiste à recueillir la différence entre deux mesures de résistance, une avec la source de courant réglée sur la valeur normale et l'autre avec la source de courant réglée sur une valeur inférieure. L'activation de la compensation de décalage multiplie environ par deux le temps de lecture.

Étape 7 : Low Power (modèles 34465A/70A uniquement) : Le mode basse puissance génère moins de courant de test par plage de mesure que la normale pour les mesures de résistance standard afin de réduire la dissipation de puissance et l'auto-échauffement du dispositif testé. Si la puissance basse est activée, une pression sur la touche **Range** entraîne l'affichage du courant inférieur généré pour chaque plage :



Les mesures de résistance de basse puissance s'appliquent uniquement aux plages 100 Ω-100 kΩ. Les plages 1 MΩ-1 GΩ génèrent le même courant, quel que soit le réglage de basse puissance.

Mesures de résistance négatives

Dans certains cas, l'instrument peut signaler des mesures de résistance négatives (notamment dans le cas des mesures de résistance en 2/4 fils ou des mesures de continuité).

Les situations suivantes peuvent générer des valeurs de résistance négatives :

- Modifications de la résistance des contacts des commutateurs avant/arrière
- Inversion des fils de mesure Hi et Lo
- Circuits présentant une polarisation externe ou des tensions thermiques aux connexions
- Changements dans la connexion de mesure suite à une opération NULL

Dans les mêmes conditions, l'instrument 34401A renvoie la valeur absolue de la mesure pour éviter toute confusion associée aux lectures négatives. Les multimètres numériques Keysight série *Truevolt* renvoient des valeurs négatives. Ce comportement permet d'obtenir des résultats extrêmement précis après une opération NULL.

Température (34460A et 34461A)

Cette rubrique concerne uniquement les multimètres numériques 34460A/61. Pour les mesures de température à l'aide du multimètre 34465A/70A, reportez-vous à la section [Température \(34465A et 34470A\)](#).

Cette section décrit la procédure à suivre pour configurer les mesures de température en 2 ou 4 fils à partir du panneau avant.

Étape 1 : Configurez les cordons de test comme indiqué.

Température 2 fils :

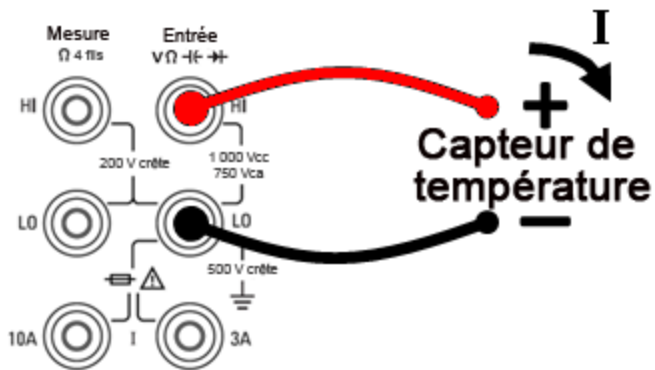

Température 4 fils :

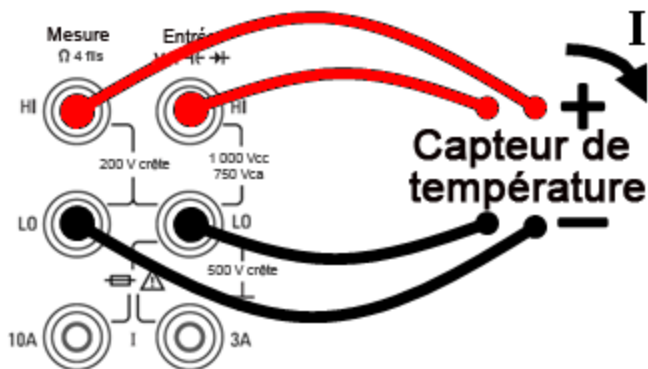

Étape 2 : Appuyez sur la touche [Temp] du panneau avant. Le menu suivant s'affiche.

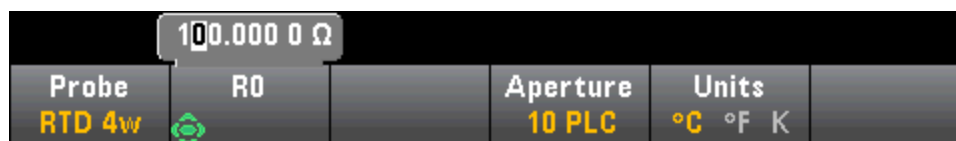

Étape 3 : Appuyez sur la touche **Probe** et choisissez un type de sonde. Si vous préférez utiliser un RTD, le menu inclut une touche de fonction qui permet de spécifier la résistance du RTD à 0 degré Celsius (R_0).



Étape 4 : Pour les mesures à 2 fils, la touche de fonction **Auto Zero** est disponible.

Auto Zero : Cette fonction permet d'obtenir des mesures de haute précision, mais exige plus de temps pour effectuer la mesure du zéro. Lorsque la fonction de réglage automatique du zéro est activée, le multimètre mesure en interne le décalage après chaque mesure. Elle soustrait ensuite cette mesure de la lecture précédente. Cette méthode évite que des tensions de décalage présentes sur le circuit d'entrée de l'instrument n'affectent la précision de mesure. Lorsque cette fonction est désactivée, le multimètre mesure le décalage une fois et soustrait ce dernier de toutes les mesures suivantes. Il recueille une nouvelle mesure du décalage chaque fois que vous modifiez la fonction, la plage ou le temps d'intégration. (Il n'existe aucun réglage du zéro automatique pour les mesures de résistance en 4 fils.)

Étape 5 : Appuyez sur **Aperture** et choisissez le nombre de cycles de tension d'alimentation (PLC) souhaités pour la mesure. Seuls 1, 10 et 100 PLC permettent une réjection (du bruit de fréquence réseau) en mode normal. La sélection de 100 PLC permet une réjection de bruit et une résolution optimales, mais ralentit les mesures :



Étape 6 : Utilisez la touche de fonction **Units** pour afficher la température en degrés Celsius, degrés Fahrenheit ou Kelvin.

Température (modèles 34465A et 34470A)

Cette rubrique concerne uniquement les multimètres numériques 34465A/70. Pour les mesures de température à l'aide du multimètre 34460A/61A, reportez-vous à la section [Température \(modèles 34460A et 34461A\)](#).

Cette section décrit la procédure à suivre pour configurer les mesures de température depuis le panneau avant. Pour les mesures de température, un capteur de température est nécessaire. Les sondes prises en charge sont des RTD en 2 et 4 fils, des thermistances en 2 et 4 fils (type 44004 de 2,2 k Ω , type 44007 de 5 k Ω et type 44006 de 10 k Ω , voir les [Exigences relatives aux thermistances](#)) et des thermocouples de type E, J, K, N, R ou T.

REMARQUE Cette section contient des informations générales sur la configuration des mesures de température. Pour un didacticiel détaillé sur les mesures de température, consultez la note d'application 290 de Keysight intitulée *Mesures de température pratiques*, disponible à l'adresse www.keysight.com.

Étape 1 : Configurez les cordons de test comme indiqué.

Température 2 fils :

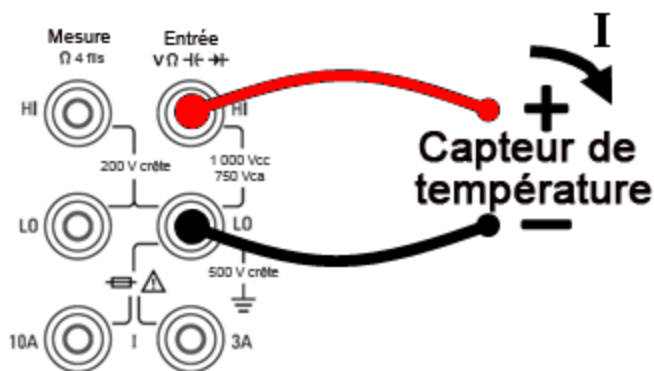

Température 4 fils :

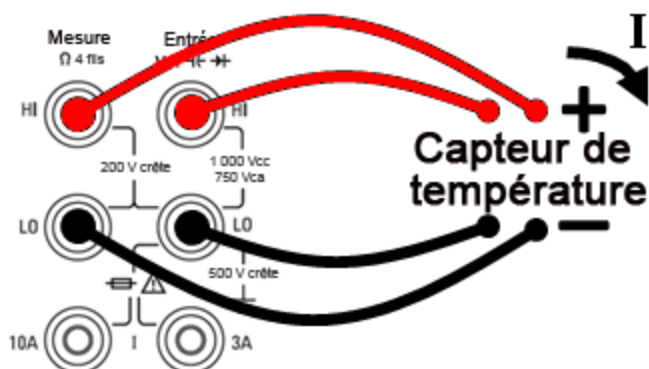

Étape 2 : Appuyez sur la touche [Temp] du panneau avant.

Étape 3 : La touche de fonction **Aperture NPLC** est sélectionnée par défaut. Utilisez les touches fléchées vers le haut/bas pour spécifier le temps d'intégration en nombre de cycles de tension d'alimentation (PLC) souhaités pour la mesure. 1, 10 et 100 PLC permettent une réjection (du bruit de fréquence réseau)

en mode normal. La sélection de 100 PLC permet une réjection de bruit et une résolution optimales, mais ralentit les mesures :



Pour définir le temps d'intégration avec précision, au lieu d'utiliser des PLC, appuyez sur **Aperture Time** et utilisez les touches fléchées vers la gauche/droite et vers le haut/bas pour spécifier le temps d'intégration en secondes. Pour **Aperture Time**, vous pouvez spécifier un temps d'intégration compris entre 200 μ s (20 μ s avec l'option DIG) et 1 s (résolution de 2 μ s) :



Étape 4 : Utilisez la touche de fonction **Units** pour afficher la température en degrés Celsius, degrés Fahrenheit ou Kelvin.

Étape 5 : Appuyez sur **Probe Settings**. Les paramètres par défaut de la sonde sont les suivants :

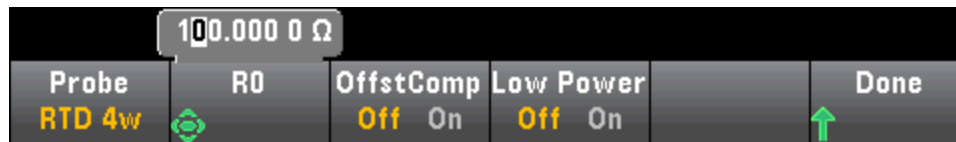

Étape 6 : Pour sélectionner un autre type de sonde, appuyez sur **Probe** et appuyez sur l'une des touches de fonction suivantes :

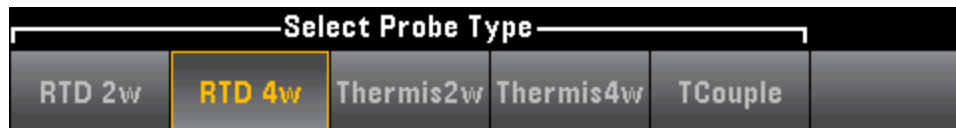

Les paramètres supplémentaires pour chaque type de sonde sont décrits dans les sections ci-dessous.

Pour les sondes de type RTD 2 fils ou RTD 4 fils...

Les sondes de type RTD 2 fils ou RTD 4 fils vous permettent de régler le R0 et d'activer/de désactiver la compensation de décalage et/ou le mode basse puissance :



R0 : R_0 correspond à la résistance nominale d'un RTD à 0 °C. 100 Ω par défaut

Compensation de décalage : Active ou désactive la compensation de décalage. La compensation de décalage élimine les effets de faibles tensions continues dans le circuit mesuré. La méthode consiste à recueillir la différence entre deux mesures de résistance, une avec la source de courant réglée sur la

Caractéristiques et fonctions

valeur normale et l'autre avec la source de courant réglée sur une valeur inférieure. L'activation de la compensation de décalage multiplie environ par deux le temps de lecture.

Basse puissance : Désactive (Off) ou active (On) les mesures de basse puissance. Le mode basse puissance génère moins de courant de test par plage de mesure que la normale pour les mesures de résistance standard afin de réduire la dissipation de puissance et l'auto-échauffement de la sonde.

Appuyez sur **Done** pour revenir au menu de température principale.

Pour la sonde de type **RTD 2w**, le paramètre **Auto Zero** supplémentaire est disponible :



Auto Zero : La fonction de réglage automatique du zéro permet d'obtenir des mesures de haute précision, mais exige plus de temps pour effectuer la mesure du zéro. Lorsque la fonction de réglage automatique du zéro est activée, le multimètre mesure en interne le décalage après chaque mesure. Elle soustrait ensuite cette mesure de la lecture précédente. Cette méthode évite que des tensions de décalage présentes sur le circuit d'entrée de l'instrument n'affectent la précision de mesure. Lorsque cette fonction est désactivée (OFF), le multimètre mesure le décalage une fois et soustrait ce dernier de toutes les mesures suivantes. Il recueille une nouvelle mesure du décalage chaque fois que vous modifiez la fonction, la plage ou le temps d'intégration. (Il n'existe aucun réglage du zéro automatique pour les mesures de résistance en 4 fils.)

Pour les sondes de type Thermistance 2 fils ou Thermistance 4 fils...

Les sondes de type Thermistance 2 fils ou Thermistance 4 fils vous permettent d'activer/de désactiver le mode basse puissance :



Basse puissance : Désactive (Off) ou active (On) les mesures de basse puissance. Le mode basse puissance génère moins de courant de test par plage de mesure que la normale pour les mesures de résistance standard afin de réduire la dissipation de puissance et l'auto-échauffement de la sonde.

Appuyez sur **Done** pour revenir au menu de température principal. Pour la sonde de type **Thermis2w**, le paramètre **Auto Zero** supplémentaire est disponible :



Auto Zero : La fonction de réglage automatique du zéro permet d'obtenir des mesures de haute précision, mais exige plus de temps pour effectuer la mesure du zéro. Lorsque la fonction de réglage automatique du zéro est activée, le multimètre mesure en interne le décalage après chaque mesure. Elle soustrait ensuite cette mesure de la lecture précédente. Cette méthode évite que des tensions de décalage présentes sur le circuit d'entrée de l'instrument n'affectent la précision de mesure. Lorsque cette fonction est

désactivée (OFF), le multimètre mesure le décalage une fois et soustrait ce dernier de toutes les mesures suivantes. Il recueille une nouvelle mesure du décalage chaque fois que vous modifiez la fonction, la plage ou le temps d'intégration. (Il n'existe aucun réglage du zéro automatique pour les mesures de résistance en 4 fils.)

Thermistance requise

Le multimètre numérique convertit la résistance de thermistance mesurée en température à l'aide de l'équation de thermistance de Steinhart-Hart suivante :

$$1/T = A + B (\ln(R)) + C (\ln(R))^3$$

où :

A, B et C sont des constantes fournies par le fabricant de la thermistance et dérivées de trois points de test de température.

R = Résistance de thermistance en Ω .

T = Température en degrés K.

Important : Utiliser uniquement une thermistance de type 44004 de 2,2 k Ω , 44007 de 5 k Ω ou 44006 de 10 k Ω . L'utilisation d'un type de thermistance incorrect peut provoquer des erreurs supérieures à 20 °C pour une température mesurée de 100 °C.

Pour un didacticiel détaillé sur les mesures de température, consultez la note d'application 290 de Keysight intitulée *Mesures de température pratiques*, disponible à l'adresse www.keysight.com.

Pour les sondes de type TCouple...

Les sondes de type TCouple vous permettent de configurer les paramètres suivants :

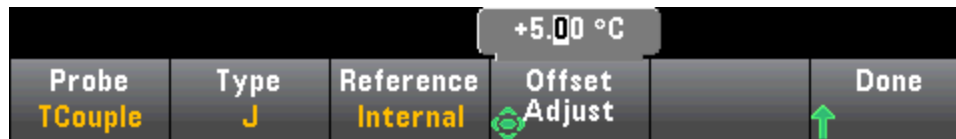

Type : Sélectionnez le type de thermocouple. Les types pris en charge sont J (valeur par défaut), K, E, T, N ou R

Référence : Les mesures par thermocouples requièrent une température de jonction de référence. Vous pouvez saisir une température de jonction de référence fixe connue (généralement utilisée pour les jonctions de référence externes) ou utiliser la température mesurée en interne des bornes avant comme température de jonction de référence. Sélectionnez la référence interne ou fixe.

Important : La température de référence interne étant égale à celle des connexions *avant*, l'utilisation des connexions *arrière* avec la sélection de la jonction de référence interne génèrera une erreur inconnue sans aucune performance spécifiée et est déconseillée.

Réglage du décalage : Vous permet d'apporter des ajustements mineurs à la température pour corriger les différences entre la mesure de température interne de la connexion avant du multimètre numérique et la température réelle des bornes de mesures. Lorsque vous sélectionnez la jonction de référence interne, la mesure de température interne des bornes avant ainsi que la valeur de décalage spécifiée sont utilisées comme température de jonction de référence. Par exemple, si la température interne mesurée est de

+20,68 °C et le décalage spécifié est de +5 °C, les fonctions mathématiques de jonction froide artificielle utilisent la somme des deux valeurs. Keysight recommande de laisser le décalage défini à la valeur 0, sauf indication contraire de la métrologie.

Décalage fixe : Lorsque vous sélectionnez la jonction de référence externe, vous devez spécifier la température de jonction de référence en degrés Celsius. Saisissez une valeur comprise entre -20 °C à +80 °C. Valeur par défaut : 0 °C. Par exemple, pour régler la température de référence fixe à +23.36 °C :

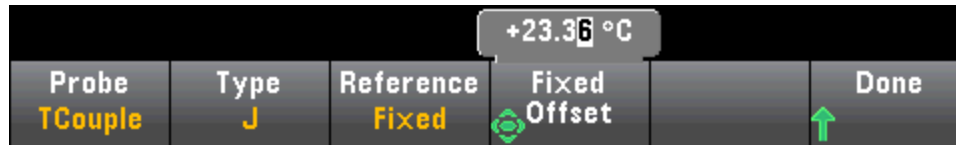

Appuyez sur **Done** pour revenir au menu de température principal qui affiche des paramètres supplémentaires pour les mesures par thermocouples :

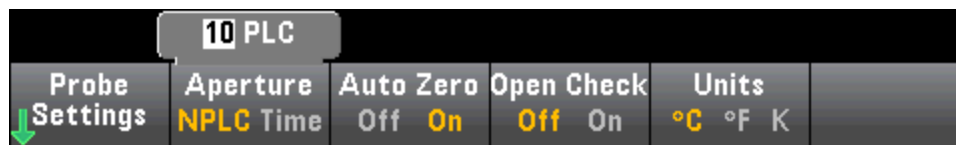

Auto Zero : La fonction de réglage automatique du zéro permet d'obtenir des mesures de haute précision, mais exige plus de temps pour effectuer la mesure du zéro. Lorsque la fonction de réglage automatique du zéro est activée, le multimètre mesure en interne le décalage après chaque mesure. Elle soustrait ensuite cette mesure de la lecture précédente. Cette méthode évite que des tensions de décalage présentes sur le circuit d'entrée de l'instrument n'affectent la précision de mesure. Lorsque cette fonction est désactivée (OFF), le multimètre mesure le décalage une fois et soustrait ce dernier de toutes les mesures suivantes. Il recueille une nouvelle mesure du décalage chaque fois que vous modifiez la fonction, la plage ou le temps d'intégration. (Il n'existe aucun réglage du zéro automatique pour les mesures de résistance en 4 fils.)

Vérification d'ouverture : Désactive ou active la fonction de *vérification des thermocouples* pour vérifier que vos thermocouples sont correctement connectés pour les mesures. Lorsque cette fonction est activée, l'instrument mesure la résistance après chaque mesure par thermocouple pour garantir une connexion adéquate. Si une connexion ouverte est détectée (supérieure à 5 kΩ sur la plage 10 kΩ), l'instrument signale une condition de surcharge.

Pour de plus amples informations sur la réalisation de mesures de température, consultez la note d'application 290 de Keysight intitulée *Mesures de température pratiques*, disponible à l'adresse www.keysight.com.

Capacité

Cette section décrit la procédure à suivre pour configurer les mesures de capacité à partir du panneau avant.

Étape 1 : Configurez les cordons de test comme indiqué.

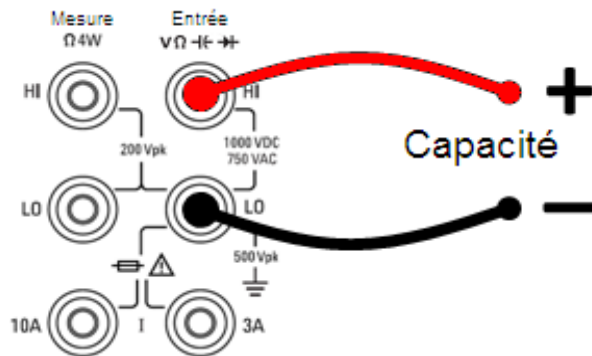

Étape 2 : Appuyez sur la touche   du panneau avant.

Étape 3 : Pour neutraliser la capacité des cordons de test :

- Débranchez la sonde des cordons de test + et - du circuit de test et laissez-la ouverte.
- Appuyez sur **Null**. Le multimètre numérique soustrait maintenant cette valeur de référence des mesures de capacité.

Étape 4 : Appuyez sur **Range** et sélectionnez une plage pour la mesure. Vous pouvez également sélectionner la plage à l'aide des touches **[+]**, **[-]** et **[Range]** du panneau avant. La fonction de commutation automatique de plage (**Auto**) sélectionne automatiquement la plage pour la mesure en fonction de l'entrée. Cette fonction est pratique, mais génère des mesures plus lentes par rapport à la fonction de commutation manuelle. La commutation automatique de plage descend d'une plage à moins de 10 % de la plage et augmente d'une plage à plus de 120 % de la plage. Pour les mesures de capacité uniquement, lorsque la fonction de commutation automatique de plage est désactivée, l'instrument ne signale pas de surcharge pour les lectures supérieures à 120 % de la plage. Une surcharge se produit uniquement une fois le délai de l'algorithme dépassé car la capacité appliquée est trop élevée pour l'algorithme à mesurer. Si vous appliquez une tension continue ou un court-circuit aux bornes d'entrée en mode de mesure de capacité, l'instrument rapporte une surcharge.



Continuité

Cette section décrit la procédure à suivre pour configurer les tests de continuité à partir du panneau avant.

Étape 1 : Configurez les cordons de test comme indiqué.

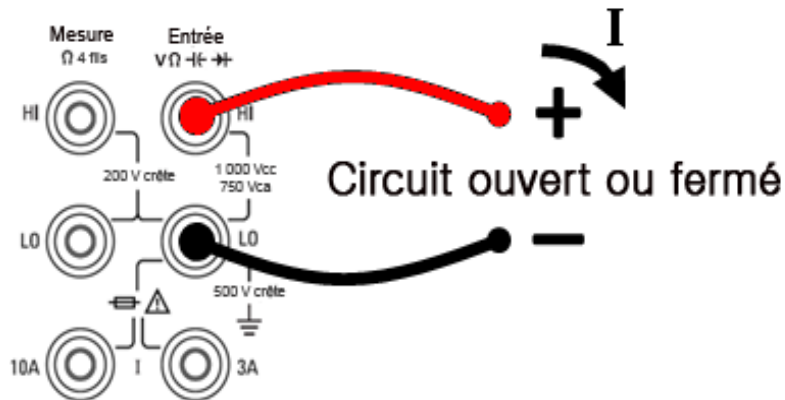

Étape 2 : Appuyez sur la touche [Cont] du panneau avant pour accéder à un menu dans lequel vous pouvez activer ou désactiver l'avertisseur sonore pour toutes les fonctions utilisant ce dernier (limites, maintien de la sonde, diode, continuité et erreurs).



Les mesures de continuité se comportent comme suit :

$\leq 10 \Omega$	affiche la résistance mesurée et émet un signal sonore (si l'avertisseur sonore est activé)
10Ω à $1,2 \text{ k}\Omega$	affiche la résistance mesurée sans émettre de signal sonore
$> 1,2 \text{ k}\Omega$	affiche l'état OPEN sans aucun signal sonore

Diode

Cette section décrit la procédure à suivre pour configurer les tests de diodes depuis le panneau avant. La plage et la résolution sont fixes ; la plage est de 10 Vcc (avec une sortie de source de courant de 1 mA).

Étape 1 : Configurez les cordons de test comme indiqué.

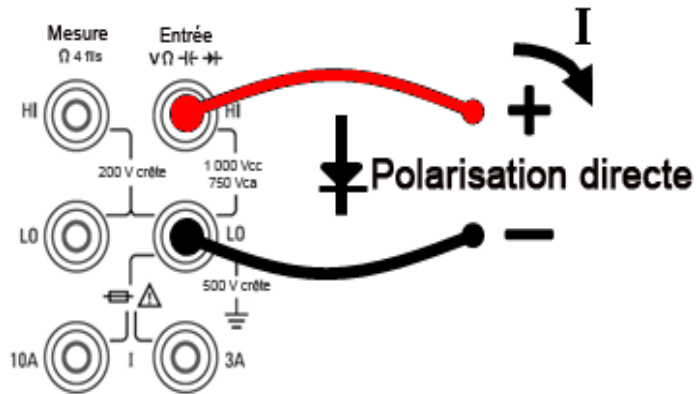

Étape 2 : Appuyez sur la touche  du panneau avant pour accéder à un menu qui indique si le multimètre numérique émettra un signal sonore pour signaler la réussite d'un test de diode.



Les mesures de diodes se comportent comme suit :

Entre 0 et 5 V	tension affichée sur le panneau avant, et l'instrument émet un signal sonore lorsque le signal passe au seuil compris entre 0,3 et 0,8 V (si l'avertisseur sonore est activé)
>5 V	le panneau avant affiche le message « OPEN » et SCPI renvoie 9.9E37

Fréquence et période

Cette section décrit la procédure à suivre pour configurer les mesures de fréquence et de période depuis le panneau avant.

Étape 1 : Configurez les cordons de test comme indiqué.

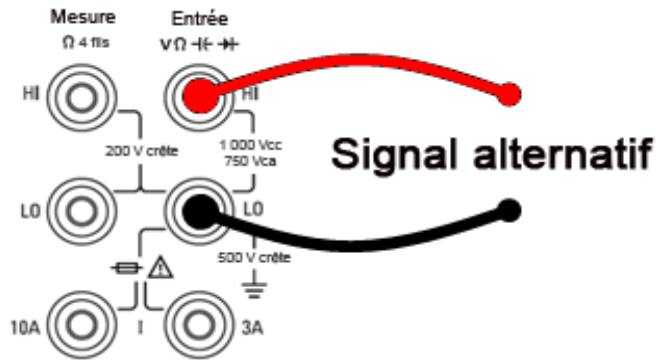

Étape 2 : Appuyez sur la touche **[Freq]** du panneau avant, puis utilisez la première touche de fonction pour choisir une mesure de fréquence ou de période.

Freq Period	Range Auto	AC Filter >20Hz	Gate Time 100ms	Timeout 1s	
-----------------------	----------------------	---------------------------	---------------------------	----------------------	--

Étape 3 : Appuyez sur **Range** et sélectionnez une plage pour la mesure. La fonction de commutation automatique de plage (**Auto**) sélectionne automatiquement la plage de la mesure en fonction de l'entrée. Cette fonction est pratique, mais génère des mesures plus lentes par rapport à la fonction de commutation manuelle. Elle augmente d'une plage à 120 % de la plage actuelle et descend d'une plage sous 10 % de la plage actuelle.

Select Frequency Voltage Range					
Auto	100mV	1V	10V	100V	750V

Étape 4 : Appuyez sur **AC Filter** et choisissez le filtre pour la mesure. L'instrument utilise trois filtres de courant alternatif différents qui vous permettent d'optimiser la précision en basse fréquence ou de réduire les temps de stabilisation en courant alternatif suite à une variation de l'amplitude du signal d'entrée.

Les trois filtres sont 3 Hz, 20 Hz et 200 Hz et vous devez généralement sélectionner le filtre à plus haute fréquence dont la fréquence est inférieure au signal que vous mesurez, car les filtres à fréquence plus élevée génèrent des mesures plus rapides. Par exemple, lors de la mesure d'un signal compris entre 20 et 200 Hz, utilisez le filtre 20 Hz.

Si la vitesse de mesure n'est pas un problème, un filtre à plus basse fréquence peut produire des mesures plus silencieuses, selon le signal que vous mesurez.



Étape 5 : Appuyez sur la touche **Gate Time** et choisissez l'ouverture de mesure (temps d'intégration) de 1 ms (modèles 34465A/70A uniquement), de 10 ms, de 100 ms (valeur par défaut) ou de 1 s.



Étape 6 : (modèles 34465A/70A uniquement) Appuyez sur **Timeout** pour déterminer la durée d'attente de l'instrument avant d'annuler une mesure de fréquence ou de période en l'absence de signal. Lorsque la durée est définie à 1 s, l'instrument patiente 1 seconde avant d'annuler la mesure. Lorsqu'elle est définie sur Auto, le délai d'attente varie en fonction de la bande passante du filtre CA ; pour les bandes passantes plus rapides, l'instrument patiente moins longtemps avant d'annuler la mesure et de renvoyer 0.0. Cela est avantageux dans les systèmes de test de fabrication dans lesquels un échec du dispositif testé peut se traduire par une absence de signal ; dans ce cas, l'échec peut être détecté plus tôt et accroître ainsi la cadence du test.



REMARQUE Pour un affichage précis des statistiques des mesures en courant alternatif en mode Panneau avant, vous devez utiliser le retard de déclenchement manuel par défaut (**[Acquire] > Delay Man**).

Enregistrement de données

Le mode Enregistrement de données est disponible de série sur les modèles 34465A et 34470A et uniquement depuis le panneau avant du multimètre. Il inclut une interface utilisateur de panneau avant qui vous permet de configurer l'enregistrement des données dans la mémoire non volatile de l'instrument, ou dans des fichiers internes/externes, sans aucune programmation ni connexion à un ordinateur. Une fois la collecte de données terminée, vous pouvez visualiser ces dernières sur le panneau avant ou bien les transférer vers l'ordinateur. Le mode Enregistrement de données vous permet de spécifier un certain nombre de mesures, ou des mesures acquises sur une période donnée, dans la mémoire de l'instrument ou dans des fichiers de données internes ou externes.

Pour sélectionner le mode Enregistrement de données, appuyez sur **[Acquire] Acquire > Data Log**. Vous pouvez ensuite sélectionner l'intervalle d'échantillonnage (laps de temps s'écoulant entre les mesures, par exemple, 500 mS), la durée, sous forme de période ou de nombre de mesures, déterminer si l'enregistrement de données doit démarrer après un délai ou à une heure précise de la journée, et si les données doivent être enregistrées en mémoire ou dans des fichiers. Après avoir configuré les paramètres d'enregistrement des données, appuyez sur **[Run/Stop]**. L'enregistrement des données commencera après le délai spécifié ou à l'heure indiquée.

Le mode Enregistrement de données est disponible pour les mesures en tension et courant continu, en tension et courant alternatifs, de résistance en 2 et 4 fils, de fréquence, de période, de température, de capacité et de rapport (la diode et la continuité sont exclues). La fréquence de lecture maximale est de 1 000 mesures/s et la durée maximale est de 100 heures, ce qui génère un nombre maximal de mesures de 360 000 000 dans le fichier. Le nombre de mesures pouvant être enregistrées en mémoire varie selon la quantité de mémoire de l'instrument. Avec l'option MEM, la limite est de 2 000 000 lectures ; sans l'option MEM, la limite est de 50 000 mesures. Par défaut, le mode de déclenchement par défaut est Automatique. Les sources de déclenchement par niveau et externe ne sont pas prises en charge pour l'enregistrement de données.

MISE EN GARDE

Une perte de données est possible. La transition du mode local au mode de commande à distance entraîne un effacement de la mémoire de l'instrument : Lors de l'enregistrement ou de la numérisation de données *en mémoire*, si vous accédez à l'instrument à distance (envoi d'une commande SCPI ou courante)* et que vous repassez en mode local (en appuyant sur **[Local]**), les lectures sont effacées de la mémoire et l'instrument repasse en mode Continu.

Pour l'enregistrement de données uniquement, vous pouvez éviter cette situation en enregistrant les données dans un fichier plutôt qu'en mémoire (pour plus de détails, voir **Mode Enregistrement de données**). Vous pouvez également empêcher cette situation pour la numérisation ou l'enregistrement des données en suivant la procédure pour que l'instrument ne soit pas accessible à distance. Pour empêcher l'accès à distance, vous pouvez déconnecter les câbles d'interface LAN, GPIB et USB de l'instrument avant de lancer les mesures. Pour éviter tout accès à distance via le réseau local, vous pouvez connecter l'instrument derrière un routeur. Vous pouvez également désactiver les différentes interfaces E/S des menus du panneau avant sous **[Utility] > I/O Config**.

Pour afficher l'état d'un enregistrement de données ou d'une opération de numérisation à distance, utilisez l'**interface utilisateur Web** de l'instrument. L'écran de l'interface utilisateur Web de l'instrument ne permet pas de paramétrer l'instrument en mode de commande à distance.

**Si l'accès est effectué à distance, l'instrument poursuit la numérisation ou l'enregistrement des données jusqu'à la fin et vous pouvez récupérer les lectures depuis l'interface de commande à distance.*

Présentation de l'enregistrement de données

Cette section est un récapitulatif des étapes nécessaires à la configuration de l'enregistrement de données. Les étapes détaillées sont décrites ci-dessous dans la section **Étapes détaillées de l'enregistrement**.

1. Sélectionnez la fonction de mesure et établissez les connexions au dispositif testé (pour plus de détails, reportez-vous à la section **Mesures**).
2. Sélectionnez le mode Enregistrement de données (appuyez sur **[Acquire] > Acquire > .Data Log**).
3. Spécifiez l'intervalle d'échantillonnage (temps entre les lectures) par exemple, 20 mS.
4. Indiquez la durée sous forme de temps ou de nombre de lectures.
5. Indiquez la date à laquelle lancer l'enregistrement de données (délai ou heure précise de la journée). Vous pouvez utiliser uniquement le déclenchement automatique (valeur par défaut) ou le déclenchement unique (appuyez sur **[Single]**) pour l'enregistrement des données.
6. Indiquez si vous souhaitez que les données soient enregistrées en mémoire ou des fichiers internes ou externes.
7. Appuyez sur **[Run/Stop]** ou sur **[Single]**. L'enregistrement des données démarre une fois le délai saisi écoulé ou l'heure de la journée échue (spécifiés à l'étape 5). L'enregistrement de données s'arrête une fois la durée spécifiée (heure ou nombre de mesures) écoulée ou après avoir appuyé à nouveau sur **[Run/Stop]**.

Étapes détaillées de l'enregistrement de données

Remarque : pour de plus amples informations, appuyez sur l'une des touches de fonctions ci-dessous et maintenez-la enfoncée (par exemple, plage de valeurs pour un paramètre donné).

Étape 1 : Sélectionnez la fonction de mesure et établissez les connexions au dispositif testé (pour plus de détails, reportez-vous à la section **Mesures**). Par exemple, appuyez sur **DCV** et configurez les cordons de test comme indiqué.

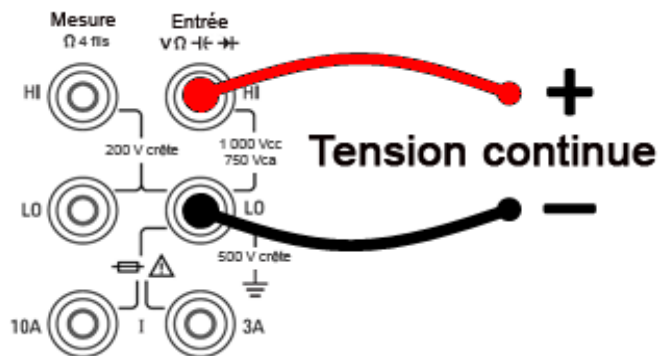

Étape 2 : Appuyez sur la touche **[Acquire]** du panneau avant, puis sur l'une des touches de fonction suivantes :

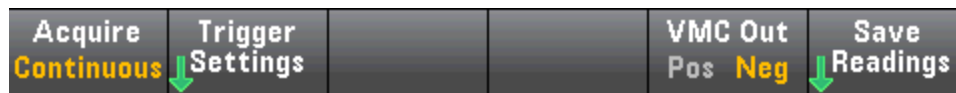

Appuyez sur la touche de fonction **Acquire**.



Appuyez sur la touche de fonction **Data Log**. Le menu Data Log s'ouvre :



Étape 3 : Appuyez sur **Sample Interval** et spécifiez l'intervalle qui s'écoule entre les échantillons (mesures).

Remarque : le message suivant est visible lors de la configuration de l'enregistrement de données : *Sample interval is limited by measurement settings* (L'intervalle d'échantillonnage est limité par les paramètres de mesure). Le temps de mesure est déterminé par la fonction de mesure, le NPLC, l'ouverture, la commutation automatique de plage, le réglage du zéro automatique, la compensation de décalage, le filtre CA, la vérification d'ouverture TC et le temps de porte. L'intervalle d'échantillonnage d'enregistrement des données ne peut pas être inférieur au temps de mesure. Vous pouvez réduire le temps de mesure en sélectionnant un temps d'intégration inférieur, en sélectionnant une plage fixe, etc.



Étape 4 : Appuyez sur la touche de fonction **Duration** pour spécifier la durée d'enregistrement des données ou appuyez à nouveau sur **Duration** pour spécifier le nombre total de mesures à enregistrer.

Étape 5 : Appuyez sur **Start** pour indiquer quand démarrer l'enregistrement de données. Vous pouvez sélectionner :

- **Start Delay** - Démarre l'enregistrement de données après un délai donné. Indiqué au format HH.MM.SS.
- **Start Time of Day** - Démarre l'enregistrement de données après une heure précise de la journée. Indiqué au format HH.MM.SS. Pour utiliser l'heure de la journée, il faut que l'horloge en temps réel de l'instrument soit correctement réglée. Pour régler l'horloge, appuyez sur **[Shift] > [Utility] > System Setup.Date/Time**.



REMARQUE Il n'est pas possible de configurer une source de déclenchement lors de l'enregistrement de données. Vous pouvez utiliser uniquement le déclenchement automatique (sélectionné par défaut) ou lorsque vous êtes prêt à lancer l'enregistrement de données, vous pouvez activer un déclenchement unique (en appuyant sur [**Single**]). Les effets sont les mêmes, car vous ne nécessitez que d'un événement de déclenchement automatique ou unique pour activer l'enregistrement de données.

Étape 6 : Appuyez sur **Log To** > **Log To Memory** ou sur **Log To Files** pour déterminer si les résultats d'enregistrement des données doivent être sauvegardés en mémoire volatile pour affichage ou être écrits dans un ou plusieurs fichiers internes/externes.

- Lors de l'enregistrement des données en mémoire, les données sont volatiles (ne sont pas conservées lors de la mise hors tension), mais peuvent être sauvegardées dans un fichier interne ou externe une fois l'enregistrement de données terminé (voir l'étape 7 ci-dessous). Le nombre de mesures pouvant être enregistré en mémoire varie selon la quantité de mémoire de l'instrument. Avec l'option MEM, la limite est de 2 000 000 lectures. Sans l'option MEM, la limite est de 50 000 lectures.

Caractéristiques et fonctions

- En cas d'enregistrement des données directement dans un fichier, **accédez** à un chemin interne ou externe et spécifiez un **nom de fichier**. Si plusieurs fichiers doivent être créés pour conserver les données, le deuxième nom de fichier portera le suffixe _0001, le troisième fichier portera le suffixe _00002, etc. En cas d'enregistrement des données dans des fichiers, le nombre maximal de mesures est de 360 000 000.



Lorsque le paramètre **Ajouter la date** est **activé**, la date et l'heure de début d'enregistrement des données sont ajoutées au nom de fichier au format suivant :

_AAAAMMJJ_HHMMSS

Par exemple, pour un fichier nommé *Données 1*, le résultat est similaire à ce qui suit : *Données 1_20140720_032542*.

Appuyez sur la touche **Options** pour configurer les options de stockage de mesures :



Rows/File - Indique le nombre maximal de lignes ou de lectures à écrire dans un fichier. Pour **Max**, la limite correspond au nombre d'octets autorisés par le système de fichiers ($2^{32} = 4,294967296$ Go). Cela représente environ 252 millions de mesures avec le paramètre Metadata désactivé ou 159 millions de mesures avec le paramètre Metadata activé. Pour **1M**, la limite est de 1 000 000 lignes dans le fichier obtenu. Cela vous permet de prendre en charge des applications d'analyse de feuilles de calcul, de bases de données et de données communes limitées à 1 million de lignes par fichier.

Metadata - Active le numéro de mesure, l'horodatage de la première lecture et l'intervalle d'échantillonnage (si celui-ci est disponible) dans le fichier.

Separator - Indique le caractère (virgule, tabulation ou point-virgule) à utiliser pour séparer les

informations présentes sur chaque ligne.

Lorsque vous avez terminé de configurer le stockage des mesures, appuyez sur **Done** > **Done** pour revenir au menu d'enregistrement de données principal.

Étape 7 : Appuyez sur **[Run/Stop]** ou sur **[Single]**. L'enregistrement des données démarre une fois le délai saisi écoulé ou l'heure de la journée échue (spécifiés à l'étape 5). L'enregistrement de données s'arrête une fois la durée saisie (heure ou nombre de mesures) écoulée ou après avoir appuyé à nouveau sur **[Run/Stop]**.

Lorsque l'enregistrement des données est terminé :

- Lors de l'enregistrement de données dans des fichiers, l'instrument sauvegarde ces derniers avec le nom et le chemin d'accès spécifiés.
- Lors de l'enregistrement de données en mémoire, vous pouvez désormais sauvegarder les mesures depuis le menu d'enregistrement de données principal en appuyant sur **Save Readings**.



Vous pouvez ensuite **accéder** à un chemin interne ou externe et spécifier un **Nom de fichier**. Vous pouvez également spécifier les **options** de stockage de mesures comme décrit ci-dessus à l'étape 6.



Diagramme de tendance pour l'enregistrement de données

Le diagramme de tendance est particulièrement utile pour la visualisation des mesures d'enregistrement de données. Pour plus de détails, reportez-vous à la section [Diagramme de tendance \(Modes Numérisation et Enregistrement de données\)](#).

Numérisation

La fonction de numérisation (concerne uniquement les modèles 34465A/70A avec l'option DIG) fournit une interface utilisateur de panneau avant qui permet de configurer rapidement les mesures numérisées. La numérisation est un processus consistant à convertir un signal analogique continu, par exemple une onde sinusoïdale en une série d'échantillons discrets (lectures) :

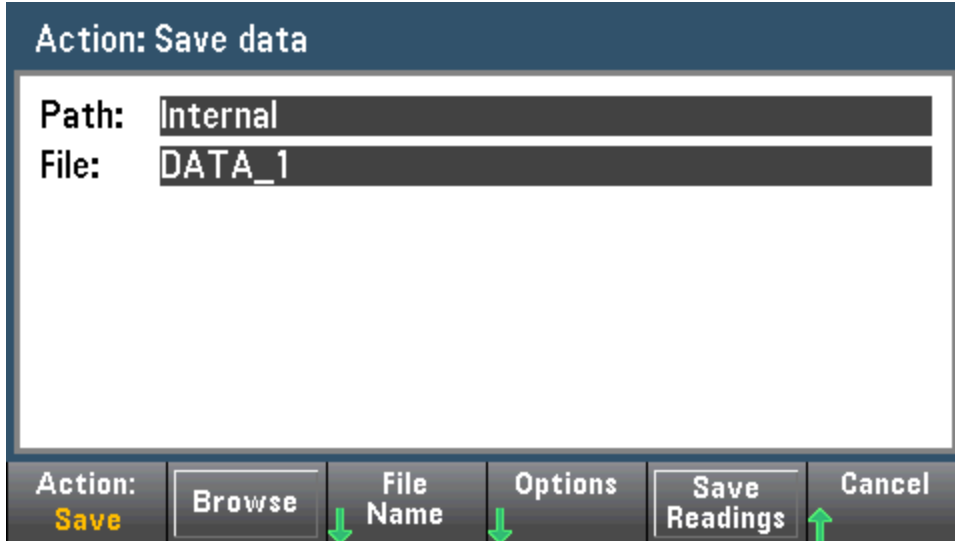
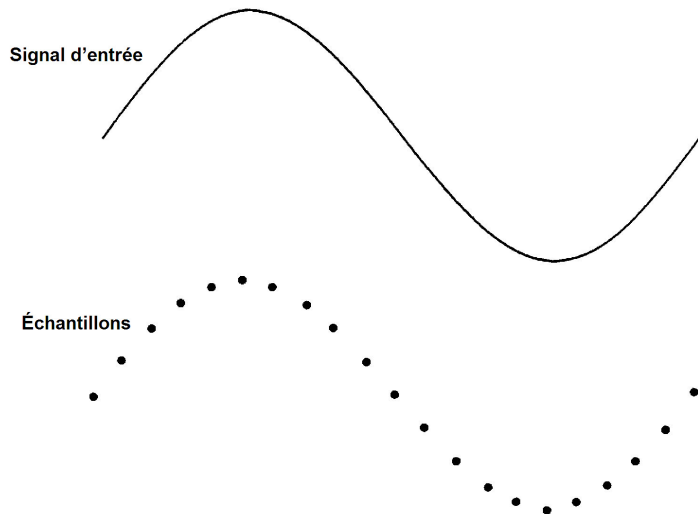

Pour un didacticiel sur la numérisation et de plus amples informations sur les fréquences d'échantillonnage et les fréquences d'entrée, reportez-vous à la section [Numérisation des mesures](#).

Le multimètre numérique numérise en échantillonnant le signal d'entrée à l'aide de la fonction V CC (par défaut) ou de la fonction I CC avec la commutation automatique de plage et le réglage automatique du zéro désactivés.

MISE EN GARDE

Une perte de données est possible. La transition du mode local au mode de commande à distance entraîne un effacement de la mémoire de l'instrument : Lors de l'enregistrement ou de la numérisation de données *en mémoire*, si vous accédez à l'instrument à distance (envoi d'une commande SCPI ou courante)* et que vous repassez en mode local (en appuyant sur **[Local]**), les lectures sont effacées de la mémoire et l'instrument repasse en mode Continu.

Pour l'enregistrement de données uniquement, vous pouvez éviter cette situation en enregistrant les données dans un fichier plutôt qu'en mémoire (pour plus de détails, voir [Mode Enregistrement de données](#)). Vous pouvez également empêcher cette situation pour la numérisation ou l'enregistrement des données en suivant la procédure pour que l'instrument ne soit pas accessible à distance. Pour empêcher l'accès à distance, vous pouvez déconnecter les câbles d'interface LAN, GPIB et USB de l'instrument avant de lancer les mesures. Pour éviter tout accès à distance via le réseau local, vous pouvez connecter l'instrument der-

rière un routeur. Vous pouvez également désactiver les différentes interfaces E/S des menus du panneau avant sous **[Utility] > I/O Config**.

Pour afficher l'état d'un enregistrement de données ou d'une opération de numérisation à distance, utilisez l'**interface utilisateur Web** de l'instrument. L'écran de l'interface utilisateur Web de l'instrument ne permet pas de paramétrer l'instrument en mode de commande à distance.

**Si l'accès est effectué à distance, l'instrument poursuit la numérisation ou l'enregistrement des données jusqu'à la fin et vous pouvez récupérer les lectures depuis l'interface de commande à distance.*

Présentation de la numérisation

Cette section est un récapitulatif des étapes nécessaires à la configuration de la numérisation. Les étapes détaillées sont décrites ci-dessous dans la section Étapes détaillées de la numérisation.

1. Sélectionnez des mesures V CC ou I CC et connectez le dispositif testé.
2. Sélectionnez le mode Numérisation (appuyez sur **[Acquire] > Acquire > Digitize**).
3. Spécifiez la fréquence d'échantillonnage (par exemple, 50 kHz) ou un intervalle d'échantillonnage (par exemple, 20 μ S).
4. Indiquez la durée sous forme de temps ou de nombre de lectures.
5. Sélectionnez la source de déclenchement (Auto, Ext ou Niveau).
 - a. Pour la source Externe, spécifiez la polarité.
 - b. Pour la source Niveau, utilisez Plage +/- pour sélectionner une plage fixe, puis indiquez le seuil et la polarité.
6. Spécifiez le temps de retard ou utilisez l'option Automatique.
7. Facultatif : Si vous utilisez une source de déclenchement par niveau ou externe, spécifiez un nombre de pré-déclenchements (nombre de lectures à stocker avant que l'événement de déclenchement ne se produise).
8. Appuyez sur **[Run/Stop]**. La numérisation démarre lorsque l'événement de déclenchement se produit et s'arrête après la durée ou lorsque vous appuyez à nouveau sur **[Run/Stop]**.
9. Enregistrez les données numérisées dans un fichier.
10. Facultatif : sélectionnez le diagramme dans lequel vous souhaitez visualiser les données numérisées.

REMARQUE Les fonctions d'histogramme et de statistiques peuvent être utilisées lors de la numérisation. Cependant, ces données ne sont mises à jour qu'une fois la numérisation terminée.

Étapes détaillées de la numérisation

Étape 1 : Pour numériser la tension continue, appuyez sur **DCV** et configurez les cordons de test comme indiqué.

Caractéristiques et fonctions

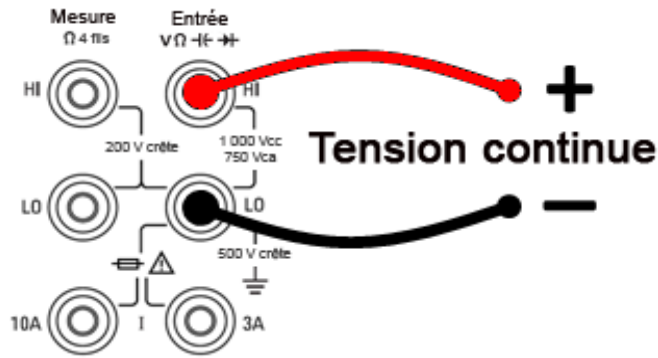

Pour numériser le courant continu, appuyez sur **DCI** et configurez les cordons de test comme indiqué.

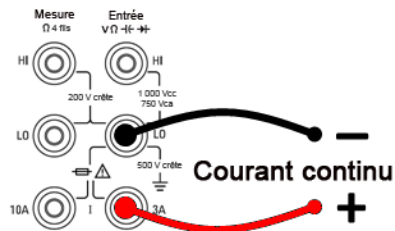

Sur les modèles 34461A/65A/70A, vous pouvez également configurer la mesure avec la borne de 10 A, qui est recommandée pour mesurer un courant supérieur à 1 A :

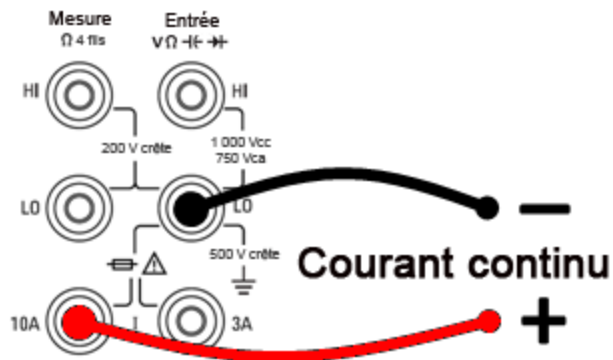

Étape 2 : Appuyez sur la touche [**Acquire**] du panneau avant, puis sur la touche de fonction **Acquire** :

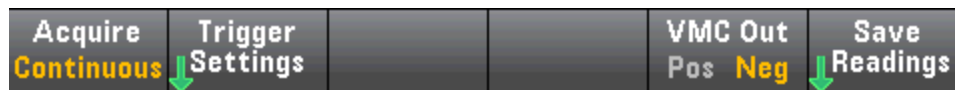

Appuyez sur la touche de fonction **Digitize** :



Étape 3 : Le menu Numérisation s'ouvre :



Après avoir sélectionné l'option **Sample Rate**, utilisez les touches fléchées vers le haut/bas pour sélectionner une fréquence d'échantillonnage en échantillons par seconde (Hz) ou appuyez sur la touche de fonction **Sample Rate** pour spécifier un intervalle d'échantillonnage (temps entre les échantillons) :



Étape 4 : Appuyez sur la touche de fonction **Duration** pour spécifier la durée à numériser :



Vous pouvez également appuyer à nouveau sur **Duration** pour spécifier le nombre total d'échantillons à numériser :



Étape 5 : Appuyez sur **Trigger Settings** pour visualiser ou modifier la source de déclenchement. Par défaut, la source de déclenchement est réglée sur Automatique. Vous pouvez également sélectionner le niveau de déclenchement externe et par niveau lors de la numérisation.



Appuyez sur **Trg Source** et sélectionnez l'une des trois sources de déclenchement :



Auto - L'instrument se déclenche automatiquement dès que vous appuyez sur **[Run/Stop]** ou **[Single]**.

Étape 5a Configuration du déclenchement externe : Après avoir appuyé sur **Ext**, ce menu apparaît :



Ext - L'instrument se déclenche lorsqu'un bord de la pente appropriée parvient au connecteur Ext Trig du panneau arrière. Vous pouvez spécifier la pente dans le menu de touches de fonction qui apparaît lorsque

Trg Src est défini sur Ext. Pour sélectionner le déclenchement externe, appuyez sur **Ext** et sélectionnez une pente positive ou négative :

Étape 5b Sélection du déclenchement par niveau : Level - (Modèles 34465A/70A avec option DIG uniquement) L'instrument émet un déclenchement lorsque le seuil de mesure indiqué se déclenche avec la pente positive ou négative spécifiée. Pour sélectionner le déclenchement par niveau, appuyez sur **Level** et spécifiez le seuil de niveau et la pente positive ou négative :

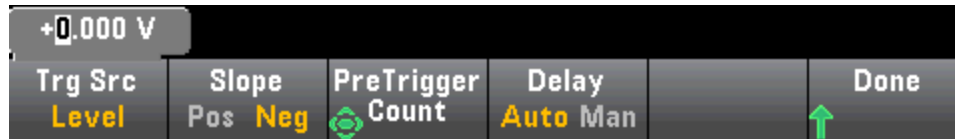

REMARQUE Sélectionnez la plage de mesure désirée à l'aide des touches **[Range] [+]** et **[-]** avant de définir la tension ou le courant de déclenchement par niveau.

Étape 6 : Spécification du retard

Spécifiez le retard qui se produit avant la numérisation. Ce retard est inséré une fois après l'événement de déclenchement et avant le début de la numérisation. Ce dernier peut être automatique (l'instrument choisit alors le retard en fonction du temps de stabilisation de l'instrument) ou manuel (vous spécifiez le retard).

Étape 7 : (Facultatif) Spécifiez le nombre de pré-déclenchements.

Lorsqu'une source de déclenchement Externe ou Niveau, vous pouvez spécifier un nombre de pré-déclenchements. Après avoir spécifié un nombre de pré-déclenchements, les mesures sont effectuées et conservées dans une mémoire tampon pendant l'attente de l'événement de déclenchement. Lorsque l'événement de déclenchement se produit, les mesures en mémoire tampon sont transférées vers la mémoire de mesures et les autres mesures sont enregistrées normalement. Si l'événement de déclenchement se produit avant que les mesures du nombre de pré-déclenchements n'aient été réalisées, l'événement de déclenchement a toujours lieu et la numérisation est effectuée sans avoir acquis toutes les mesures de pré-déclenchement. Le nombre de pré-déclenchements est limité à un moins le nombre total de mesures spécifiées qui doivent être acquises via le paramètre Durée.

Étape 8 : Appuyez sur la touche **[Run/Stop]** pour lancer le processus de numérisation. La numérisation commence lorsque l'événement de déclenchement spécifié se produit une fois le retard saisi écoulé. **Le message Digitizing** (Numérisation en cours) est affiché en haut de l'écran pendant la numérisation ; une fois l'opération terminée, le message **Digitize Stopped** (Numérisation arrêtée) s'affiche.

Étape 9 : Toutes les mesures réalisées pendant la numérisation sont sauvegardées dans la mémoire volatile. Une fois la numérisation terminée, appuyez sur la touche de fonction **Save Readings** pour spécifier un emplacement de fichier et enregistrer les mesures.

Étape 10 : (Facultatif) Appuyez sur **Display > Display Trend** pour visualiser le diagramme de tendance. Le diagramme de tendance est particulièrement utile pour la visualisation et l'analyse des mesures numérisées. Les curseurs X et Y (indiqués ci-dessous), les curseurs de suivi et les commandes de panoramique/zoom vous permettent d'analyser les données numérisées. Pour plus de détails, reportez-vous à la section **Diagramme de tendance (Modes Numérisation et Enregistrement de données)**.

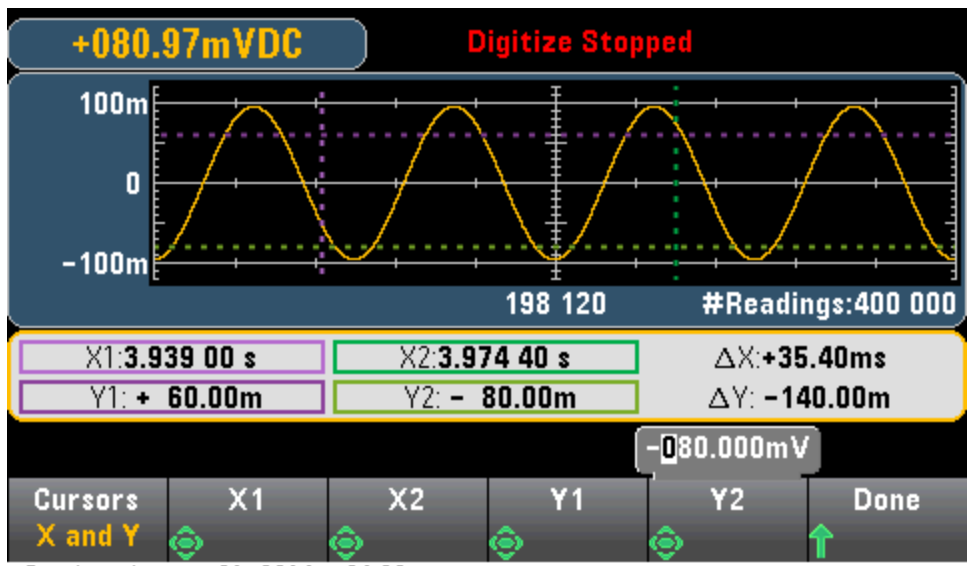

Sunday, August 31, 2014 - 04:08

Déclenchement par niveau

Le déclenchement par niveau est uniquement disponible sur les modèles 34465A/70A équipés de l'option DIG. Il permet de déclencher des mesures en un point précis du signal d'entrée, par exemple lorsque le signal franchit zéro volts ou lorsqu'il atteint le point central de son amplitude de crête positive ou négative. Par exemple, ce graphique illustre un échantillonnage commençant au point où le signal d'entrée croise 0 V avec une pente positive :

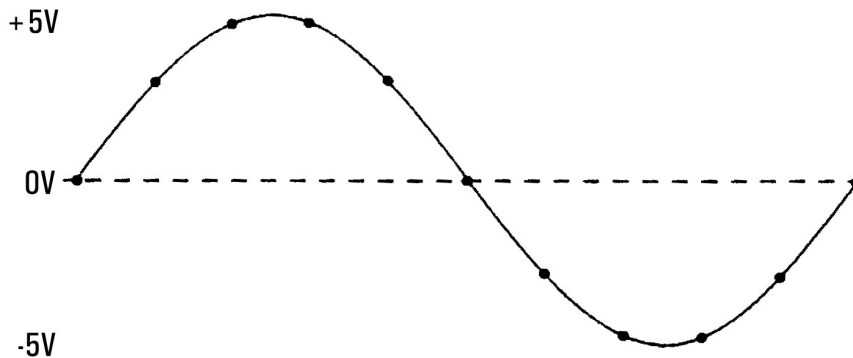

À propos du déclenchement par niveau

Le déclenchement par niveau est disponible pour ces fonctions de mesure :

- Tension continue et courant continu
- Tension alternative et courant alternatif
- Résistance à 2 et 4 fils avec compensation de décalage désactivée, et basse puissance désactivée
- Capteurs de température, RTD ou de thermistance uniquement
- Fréquence et période

Le déclenchement par niveau est sensible aux fronts. En effet, l'instrument doit détecter une *variation* de la quantité mesurée entre un côté du réglage de niveau et l'autre côté (direction déterminée par le paramètre Pente). Par exemple, si la pente est positive, alors la quantité mesurée doit d'abord atteindre une valeur *inférieure* au niveau défini avant qu'un événement de déclenchement ne puisse être détecté.

Les performances de déclenchement par niveau ne sont pas homogènes. Sa précision, sa latence et sa sensibilité dépendent d'autres fonctions du multimètre numérique. Ces dépendances varient selon la fonction de mesure comme décrit ci-dessous.

Considérations relatives à la tension continue, au courant continu et à la résistance à 2 fils :

Ces fonctions de mesure peuvent utiliser un détecteur à réponse rapide intégré au matériel pour des mesures de plage fixe. Pour une latence minimale et une sensibilité maximale, utilisez une plage fixe lors de l'utilisation du déclenchement par niveau. Cependant, la précision du niveau de déclenchement est réduite lorsque le détecteur de matériel est utilisé.

Pour augmenter la précision du niveau de déclenchement et réduire la sensibilité (évités les déclenchements inopportuns en raison du bruit), utilisez la commutation automatique de plage :

- Lorsque la fonction automatique de plage est activée, la précision du niveau de déclenchement et la latence augmentent et la sensibilité diminue car le réglage Ouverture ou NPLC augmente.
- Lorsque la commutation automatique de plage est activée, la précision du niveau de déclenchement et la latence augmentent et la sensibilité diminue si le réglage automatique du zéro est activé.
- Lorsque la commutation automatique de plage est activée, des modifications de la plage peuvent être effectuées pendant le passage du déclenchement, ce qui peut provoquer une latence/incertitude supplémentaires.

Considérations relatives à la résistance à 4 fils et la température

- La précision du niveau de déclenchement et la latence augmentent et la sensibilité diminue car le réglage Ouverture ou NPLC augmente.
- La plage fixe (uniquement disponible pour la résistance) élimine les incertitudes (en raison du changement de plage) en matière de latence de déclenchement.

Considérations relatives à la tension et au courant alternatifs

- La latence de déclenchement augmente et la sensibilité diminue car la bande passante du filtre augmente.
- La latence de déclenchement peut être contrôlée par le paramètre de retard de déclenchement.
- La plage fixe élimine les incertitudes (en raison du changement de plage) en matière de latence de déclenchement.
- Les incertitudes de commutation automatique de plage s'aggravent lorsque la bande passante du filtre augmente.

Considérations relatives à la fréquence et à la période

- La précision du niveau de déclenchement et la latence augmentent et la sensibilité diminue car le temps de porte augmente.
- La plage de tension fixe élimine les incertitudes (en raison du changement de plage) en matière de latence de déclenchement.

Mesures secondaires

La plupart des fonctions de mesure vous permettent de sélectionner et d'afficher une fonction de mesure secondaire. Les mesures secondaires peuvent être uniquement affichées sur les affichages Number (Nombre) et Bar Meter (Barre de mesure). Par exemple, une mesure de température de thermistance (principale) et la mesure de résistance effectuée sur la thermistance (secondaire) sont présentées ci-dessous :

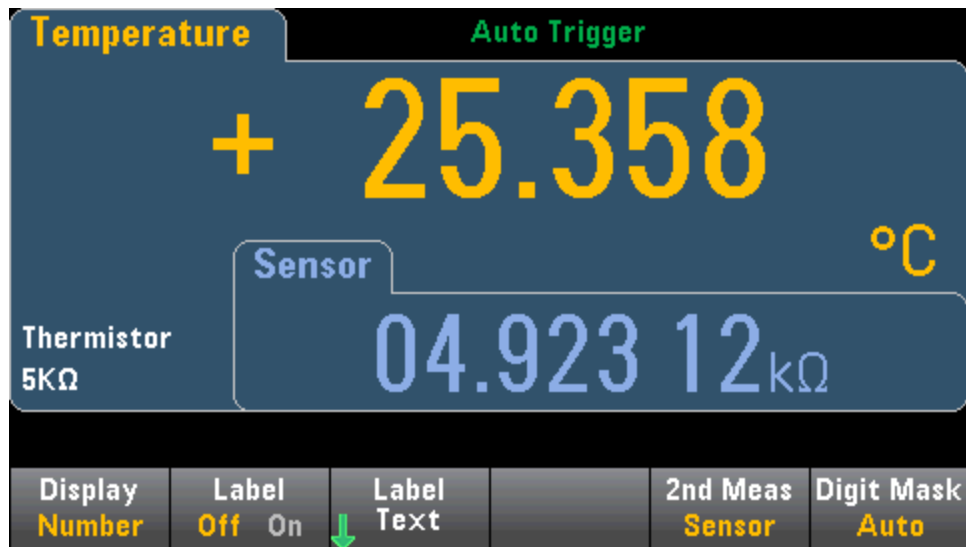

Pour sélectionner une mesure secondaire sur le panneau avant, sélectionnez d'abord la fonction de mesure principale, puis appuyez sur **Display** :

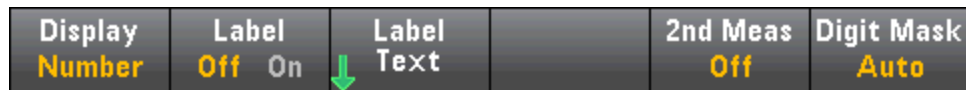

Appuyez sur **2nd Meas** pour sélectionner et afficher la mesure secondaire.

Les fonctions de mesure principales et les mesures secondaires associées pour chaque modèle de multimètre numérique sont les suivantes :

Fonction de mesure principale	Fonctions de mesure secondaire des multimètres 34460A/61A	Fonctions de mesure secondaire des multimètres 34465A/70A
V CC	V CA ¹	V CA ¹ , Crête, Opération mathématique préalable
V CA	Fréquence	V CC ¹ , Fréquence, Opération mathématique préalable
Résistance à 2 et 4 fils		Opération mathématique préalable
I CC	I CA ¹	I CA ¹ , Crête, Opération mathématique préalable
I CA	Fréquence	I CC ¹ , Fréquence, Opération mathématique préalable
Fréquence	Période	Période, V CA, Opération mathématique préalable

Période	Fréquence	Période, V CA, Opération mathématique préalable
Température	Capteur	Sonde, Opération mathématique préalable
Rapport	Entrée/Réf	Entrée/Réf, Opération mathématique préalable
Capacité		Opération mathématique préalable
Cont		Aucun
Diode		Aucun

où :

- Opération mathématique préalable - Valeur de mesure précédant toute opération mathématique (notamment l'opération NULL).
- Capteur - Valeur de capteur brute ; résistance de thermistance/RTD, tension du thermocouple (les mesures par thermocouples concernent uniquement les modèles 34465A et 34470A).
- Entrée/Réf : Mesures de la tension de signal continue et de la tension de référence continue.
- Crête - Affiche un historique en cours des valeurs de crête minimale, de crête maximale et de crête à crête du signal d'entrée. Les mesures de crête sont rapides (ouverture effective de 16 μ s) et sont différentes des valeurs min., max. et crête à crête regroupées dans Statistics (Statistiques).

¹ Après avoir réalisé une ou plusieurs mesures principales en courant continu pendant environ 4 secondes, le multimètre numérique procède à une mesure secondaire.

Pour la mesure secondaire de crête, la touche de fonction **Clear Peaks** vous permet d'effacer l'historique cumulé de la fonction crête à crête (réinitialise l'enregistrement des valeurs de crête).



Déclenchement et lectures

Le modèle de déclenchement et l'importante mémoire de mesures des multimètres série Truevolt offrent des fonctionnalités polyvalentes adaptées à une vaste gamme d'applications.

Modèle de déclenchement de l'instrument

L'acquisition de mesures sur le multimètre numérique s'effectue toujours en résultat d'un déclenchement. Cette section décrit la procédure à suivre pour configurer le déclenchement pour le mode de mesure continu. Pour le modèle 34465A/70A, reportez-vous aux sections **Numérisation** et **Enregistrement de données** afin d'obtenir des informations sur le déclenchement dans ces modes de mesure.

Pour le modèle 34460A/61A, le fait d'appuyer sur la touche **[Acquire]** entraîne l'ouverture du menu suivant :



Pour le modèle 34465A/70A, le fait d'appuyer sur la touche **[Acquire]** entraîne l'ouverture du menu suivant :



Appuyez sur **Trigger Settings** pour ouvrir le menu suivant :



Les menus ci-dessus vous permettent de configurer le déclenchement des mesures. Vous pouvez également utiliser la touche de fonction **VMC Out** pour définir la pente de front de la sortie **VM Comp** (Mesure terminée) sur le panneau arrière de l'instrument. Ce connecteur émet un signal chaque fois que le volt-mètre termine une mesure, ceci afin de vous permettre de signaler d'autres dispositifs dans un système de mesure.

REMARQUE Pour un affichage précis des statistiques des mesures en courant alternatif en mode Panneau avant, vous devez utiliser le retard de déclenchement manuel par défaut (**[Acquire]** > **Delay Man**).

Le menu (**Trg Src**) vous permet de sélectionner l'une des trois sources de déclenchement suivantes :



Auto - L'instrument effectue des mesures en continu, et émet automatiquement un nouveau déclenchement dès que la mesure est terminée.

Single - L'instrument émet un déclenchement chaque fois que la touche **[Single]** du panneau avant est enfoncée.

Ext - (Option LAN requise sur le modèle 34460A) L'instrument émet un déclenchement chaque fois qu'un front de la pente appropriée atteint le connecteur Ext Trig du panneau arrière. Vous pouvez spécifier la pente dans le menu de touches de fonction qui apparaît lorsque **Trg Src** est défini sur Ext.

Level - (Modèles 34465A/70A avec option DIG uniquement) L'instrument émet un déclenchement lorsque le seuil de mesure indiqué se déclenche avec la pente positive ou négative spécifiée.

Dans les modes Unique et Ext, vous pouvez spécifier le nombre d'échantillons à relever par déclenchement à l'aide de la touche de fonction **Samples/Trigger**. Les modes Unique et Ext peuvent tous deux mettre un déclenchement en mémoire tampon. Ainsi, lorsque vous appuyez sur **[Single]** ou que vous recevez un déclenchement externe alors qu'une série de mesures est en cours, l'instrument termine cette série de mesures, puis lance immédiatement une nouvelle série de mesures en fonction du déclenchement.

Si plusieurs déclenchements **[Single]** ou externes sont émis pendant une série de mesures, tous les déclenchements reçus après le premier sont ignorés.

Le menu **[Acquire]** permet également de configurer le retard qui se produit avant la réalisation de chaque mesure, quel que soit le mode de déclenchement (Auto, Unique ou Ext). Cette valeur peut être définie automatiquement (le retard dépend du temps de stabilisation du multimètre numérique) ou manuellement (vous spécifiez le retard).

Enfin, notez la présence des touches **[Run/Stop]** et **[Single]** sur le panneau avant. En mode de déclenchement automatique, la touche **[Run/Stop]** permet d'arrêter et de reprendre des mesures, alors que la touche **[Single]** permet de faire basculer l'instrument en mode de déclenchement unique. Dans les modes Unique et Ext, la touche **[Run/Stop]** permet d'arrêter les lectures en cours ou de basculer en mode Auto si les lectures sont arrêtées.

Retard de déclenchement et échantillons multiples

L'instrument insère un retard de déclenchement entre l'occurrence d'un déclenchement et la première mesure. Lorsque **Auto** est utilisé (touche de fonction **Delay Auto**), l'instrument détermine automatiquement le délai selon la fonction, la plage et le temps d'intégration. Pour de plus amples informations, reportez-vous à la section **Retards de déclenchement automatiques**. Cependant, vous pouvez peut-être définir manuellement un retard (touche de fonction **Delay Man**) plus long que le retard automatique afin de permettre la stabilisation de l'entrée avant de cadencer une rafale de mesures, pour les mesures avec de longs câbles ou pour les mesures de haute capacité ou de signaux à haute impédance.

Si vous avez configuré l'instrument pour plusieurs échantillons par déclenchement (touche de fonction **Samples/Trigger**), dans tous les cas, le premier échantillon est acquis avec un délai de retard après le déclenchement. Passé ce délai, la fréquence d'échantillonnage varie selon que vous sélectionnez un échantillonnage immédiat (touche de fonction **Sample Immediate**, paramètre par défaut) ou un temporisateur d'échantillonnage (touche de fonction **Sample Timer**) comme décrit ci-dessous.

- **Sample Immediate** - Le premier échantillon commence avec un délai de retard après le déclenchement, puis le délai de déclenchement est inséré entre les échantillons successifs :

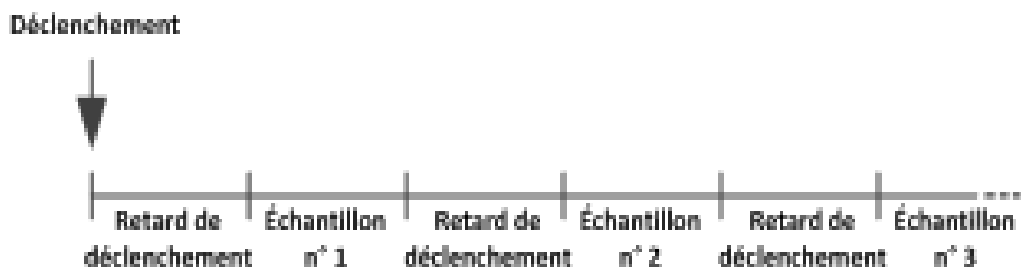

Dans cette configuration, la fréquence d'échantillonnage n'est pas déterminante, car le temps de retard est inséré à la fin de chaque échantillonnage. La durée réelle nécessaire pour prélever chaque échantillon varie selon le temps d'intégration et le temps de commutation automatique.

- **Sample Timer** - Le premier échantillon commence avec un délai de retard après le déclenchement. Le deuxième échantillon commence un intervalle d'échantillonnage après le début du premier échantillon, etc. :

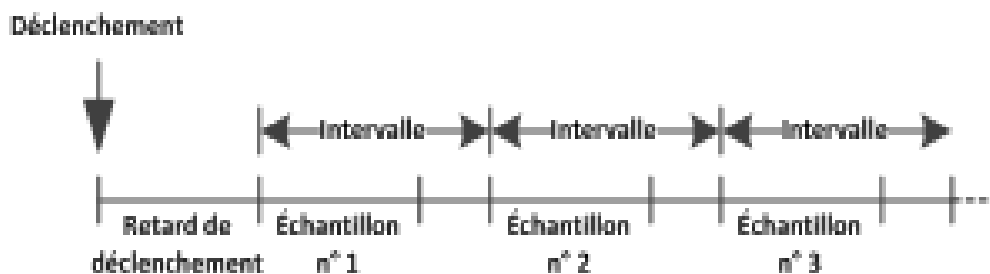

Dans cette configuration, la fréquence d'échantillonnage est déterminante, car le début de chaque échantillon est déterminé par l'intervalle d'échantillonnage spécifié (le retard de déclenchement n'affecte que le début du premier échantillon). Le temps d'intégration et la

commutation automatique de plage affectent le temps d'échantillonnage de chaque échantillon, mais pas l'intervalle d'échantillonnage. L'échantillonnage périodique se poursuit jusqu'à ce que le nombre d'échantillons désiré (réglé avec la touche de fonction **Samples/Trig**) soit obtenu.

REMARQUE Sur le panneau avant, l'instrument vous empêche de spécifier un temporisateur d'échantillonnage qui est plus court que le temps nécessaire pour effectuer des mesures basées sur la fonction, la plage et le temps d'intégration actuels.

Stockage et effacement de mesures

Vous pouvez enregistrer jusqu'à 1 000 mesures dans la mémoire de lecture du modèle 34460A, 10 000 mesures dans celle du modèle 34461A, 50 000 mesures sur le modèle 34465A/70A (sans l'option MEM) ou 2 000 000 mesures sur le modèle 34465A/70A (avec l'option MEM). Les mesures sont stockées dans une mémoire tampon de type « premier entré/premier sorti » (FIFO) ; lorsque la mémoire de mesures est saturée, les mesures plus anciennes sont remplacées par de nouvelles.

En mode Local (panneau avant), l'instrument collecte les lectures, les statistiques et les informations du diagramme de tendance et de l'histogramme en arrière-plan. Ainsi, si l'utilisateur sélectionne l'une de ces options, les données peuvent être visualisées instantanément. En mode de commande à distance (SCPI), l'instrument ne recueille pas ces informations par défaut.

Le passage de l'instrument du mode Local au mode Commande à distance n'entraîne PAS l'effacement des lectures. Le passage de l'instrument du mode Local au mode Commande à distance n'entraîne PAS l'effacement des lectures en mémoire.

En règle générale, vous activez et désactivez la lecture des mesures en appuyant sur la touche **[Run/Stop]**, comme illustré ci-dessus. Vous pouvez également relever une lecture ou un nombre donné de lectures en appuyant sur la touche **[Single]**.

Pour sauvegarder des lectures, appuyez sur **[Acquire] > Save Readings**. Puis, utilisez le menu qui apparaît pour configurer l'emplacement d'enregistrement des lectures :



Pour plus de détails, reportez-vous à la section **Menu Utility (Utilitaire) - Manage Files (Gérer les fichiers)**.

Pour les modèles 34460A/61A uniquement, appuyez sur **Save Readings** pour enregistrer les lectures en mémoire dans un fichier.

Pour les modèles 34465A/70A uniquement, appuyez sur **Options** pour configurer les options de stockage de lectures :



Rows/File - Indique le nombre maximal de lignes ou de lectures à écrire dans un fichier.

- Pour **Max**, la limite correspond au nombre d'octets autorisés par le système de fichiers ($2^{32} = 4,294967296$ Go). Cela représente environ 252 millions de mesures avec le paramètre Metadata désactivé ou 159 millions de mesures avec le paramètre Metadata activé.

Caractéristiques et fonctions

- Pour **1M**, la limite est de 1 000 000 lignes dans le fichier obtenu. Cela vous permet de prendre en charge des applications d'analyse de feuilles de calcul, de bases de données et de données communes limitées à 1 million de lignes par fichier.

Metadata - Active le numéro de mesure, l'horodatage de la première lecture et l'intervalle d'échantillonnage (si celui-ci est disponible) dans le fichier.

Separator - Indique le caractère (virgule, tabulation ou point-virgule) à utiliser pour séparer les informations présentes sur chaque ligne.

Une fois la configuration du stockage de lectures terminée, appuyez sur **Done** > **Save Readings** pour sauvegarder les lectures en mémoire dans un fichier.

Effacement de la mémoire de mesures

Les actions suivantes entraînent l'effacement de la mémoire de mesures :

- Changement de fonction de mesure
- Sélection d'une touche de fonction **Clear Readings**
- Entrée ou sortie du mode Probe Hold (Maintien de la sonde)
- Modification des unités de température
- Modification des paramètres dB/dBm
- Modification d'un paramètre de binning de l'histogramme
- Modification de la sonde de température ou de R_0
- Rappel d'une configuration enregistrée
- Étalonnage de l'instrument
- Basculement entre les entrées 3 A et 10 A
- Changement de position du commutateur Front/Rear (Avant/Arrière)
- Passage du mode Commande à distance au mode Local
- Activation/désactivation ou modification de la valeur de référence

Les actions suivantes n'entraînent pas l'effacement de la mémoire de mesures :

- Modification des paramètres de mesure, tels que la plage et l'ouverture.
- Activation ou désactivation des limites, ou réglage des valeurs limites
- Sélection de la touche **[Run/Stop]** en mode de déclenchement automatique du panneau avant
- Modification de la touche de fonction **Recent/All** du diagramme de tendance (34461A/65A/70A uniquement)
- Modification des échantillons par déclenchement ou du retard de déclenchement
- Modification des modes d'affichage
- Modification de la polarité de sortie **VM Comp**
- Modification du masque de chiffres
- Modification de l'échelle de l'histogramme, de la barre de mesure ou du diagramme de tendance
- Modification des préférences de l'utilisateur
- Exécution de l'autotest

Probe Hold (Maintien de la sonde)

Le sondage de petites zones exigeant une grande concentration, il est souvent difficile de lire l'écran de l'instrument pendant la réalisation des mesures. C'est pourquoi le panneau avant de l'instrument inclut une touche appelée **[Probe Hold]** qui vous permet d'effectuer des mesures sans regarder l'écran. Vous pouvez générer jusqu'à huit lectures et les figer à l'écran en vue de leur consultation ultérieure. Ces lectures peuvent correspondre à différents types de mesures, et vous pouvez effacer les mesures affichées à tout moment.

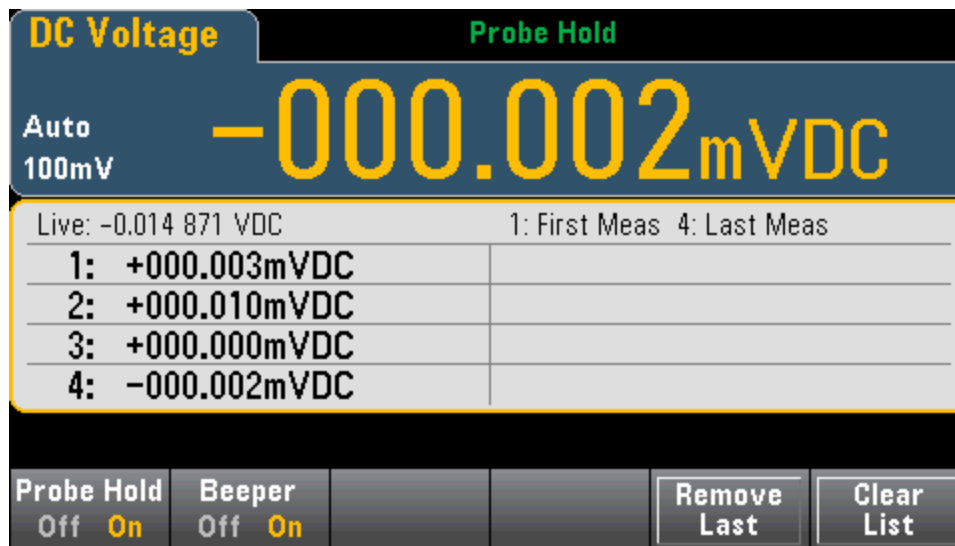

En mode Probe Hold, l'instrument optimise les paramètres de mesure pour permettre une détection fiable des signaux stables (ces paramètres reviennent à leurs valeurs d'origine lorsque vous quittez le mode). Lorsque vous sondez un signal, l'instrument émet un signal sonore et enregistre automatiquement une mesure lorsqu'il détecte une série de lectures stables. Vous pouvez réaliser d'autres mesures sans appuyer à nouveau sur la touche **[Probe Hold]**.

Appuyez sur **Remove Last** pour supprimer le nom d'utilisateur de la liste des utilisateurs. Appuyez sur **Clear List** pour supprimer le nom d'utilisateur de la liste des utilisateurs.

L'écran Probe Hold étant optimisé pour les lectures en mode Probe Hold, vous ne pouvez pas le combiner avec d'autres modes d'affichage, tels que Histogramme, Diagramme à barres, Diagramme de tendance ou Statistiques.

La fonction Probe Hold fait uniquement partie intégrante du panneau avant. Les mesures enregistrées dans ce mode sont accessibles à partir de l'interface de commande à distance. Cependant, vous pouvez effectuer une capture d'écran de l'affichage Probe Hold. Pour plus de détails, reportez-vous à la section [Menu Utility \(Utilitaire\) - Manage Files \(Gérer les fichiers\)](#).

Math (Opération mathématique) - Introduction

La touche **[Math]** correspond à la touche **[Null]** combinée à la touche Shift :



Ces fonctions mathématiques sont disponibles pour les modèles 34460A/61A :



- Null (Valeur de référence)
- dB/dBm Scaling (Réglage d'échelle dB/dBm)
- Statistics (Statistiques)
- Limits (Limites)

Ces fonctions mathématiques sont disponibles pour les modèles 34465A/70A :



- Null (Valeur de référence)
- Smoothing Filter (Filtre de lissage)
- Scaling (Réglage d'échelle)
- Statistics (Statistiques)
- Limits (Limites)

Math (Opération mathématique) - Null (Valeur de référence)

Une lecture de valeur de référence est une valeur qui est soustraite de toutes les mesures suivantes. Cette valeur est spécifique à la fonction actuelle et persiste, même lorsque vous quittez cette fonction et y revenez ultérieurement.

Cette fonction est souvent utilisée pour supprimer la résistance des fils d'une mesure de résistance. Pour ce faire, court-circuitez simplement les fils de test ensemble et appuyez sur **[Null]**. Pour d'autres fonctions de mesure, placez les sondes sur un circuit de valeur de référence avant d'appuyer sur la touche **[Null]**.

Vous pouvez également spécifier une valeur de référence en appuyant sur la touche **[Math]**, en modifiant la première touche de fonction **Value** et en saisissant la valeur à l'aide des touches fléchées. Pour désactiver la fonction de valeur de référence, appuyez à nouveau sur **[Null]** ou sur **[Math]** et réglez la première touche de fonction sur **Off**.



Voir également

[Math \(Opération mathématique\) - Introduction](#)

[dB/dBm Scaling \(Réglage d'échelle dB/dBm\)](#)

[Statistics \(Statistiques\)](#)

[Limits \(Limites\)](#)

Math (Opération mathématique) - dB/dBm Scaling (Réglage d'échelle dB/dBm)

REMARQUE

Cette rubrique décrit la procédure de réglage d'échelle dB/dBm pour les modèles 34460A/61A. Les fonctions de réglage d'échelle sont différentes pour les modèles 34465A/70A et sont décrites dans la section [Réglage d'échelle](#).

Les fonctions de réglage d'échelle dB et dBm, qui s'appliquent uniquement aux mesures en tension alternative et continue, vous permettent de régler l'échelle des mesures par rapport à une valeur de référence.

REMARQUE

Le réglage d'échelle est paramétré sur OFF lorsque vous changez de fonction de mesure (par exemple, lors du passage d'une tension continue à une tension alternative). Vous devez réactiver le réglage d'échelle après avoir changé de fonction de mesure.

Menus du panneau avant

Les fonctions dB et dBm sont accessibles à partir de la deuxième touche de fonction du menu [Math].



Lorsque la première touche de fonction du menu dB / dBm est activée, comme indiqué ci-dessous, l'un des menus suivants s'affiche :

Si la fonction est dB :



Si la fonction est dBm :



Réglage d'échelle dB

Chaque mesure dB représente la différence entre le signal d'entrée et une valeur de référence enregistrée, les deux valeurs étant converties en dBm :

$$\text{dB} = \text{mesure en dBm} - \text{valeur de référence en dBm}$$

La valeur relative doit être comprise entre -200 et +200 dBm (0 par défaut). Vous pouvez mesurer cette valeur en appuyant sur la touche **Measure Ref Value** ou bien saisir une valeur spécifiée.

Réglage d'échelle dBm

La fonction dBm est logarithmique, et compare la puissance fournie à une résistance de référence, par rapport à 1 milliwatt :

$$\text{dBm} = 10 \times \log_{10} (\text{mesure}^2 / \text{résistance de référence} / 1 \text{ mW})$$

La valeur de résistance de référence (**Ref R**) peut être 50, 75, 93, 110, 124, 125, 135, 150, 250, 300, 500, 600 (valeur par défaut), 800, 900, 1 000, 1 200 ou 8 000 Ω . Appuyez sur **Ref R** et utilisez les touches fléchées vers le haut et bas du panneau avant pour effectuer votre sélection.

Voir également

[Math \(Opération mathématique\) - Introduction](#)

[Null \(Valeur de référence\)](#)

[Statistics \(Statistiques\)](#)

[Limits \(Limites\)](#)

Math (Opération mathématique) - Scaling (Réglage d'échelle)

REMARQUE

Cette rubrique décrit la procédure de réglage d'échelle dB/dBm pour les modèles 34465A/70A. Les fonctions de réglage d'échelle sont différentes pour les modèles 34460A/61A et sont décrites à la section [Menus de réglage d'échelle dB/dBm](#).

Appuyez sur la touche de fonction **Scaling** pour accéder au menu de réglage d'échelle dB par défaut :



Appuyez sur la touche de fonction **Function** pour sélectionner une fonction de réglage d'échelle :



REMARQUE Le réglage d'échelle est paramétré sur OFF lorsque vous changez de fonction de mesure (par exemple, lors du passage d'une tension continue à une tension alternative). Vous devez réactiver le réglage d'échelle après avoir changé de fonction de mesure.

Réglage d'échelle dB

Chaque mesure dB représente la différence entre le signal d'entrée et une valeur de référence enregistrée, les deux valeurs étant converties en dBm :

$$\text{dB} = \text{lecture en dBm} - \text{valeur de référence en dBm}$$

La valeur relative doit être comprise entre -200 et +200 dBm (0 par défaut). Vous pouvez mesurer cette valeur en appuyant sur la touche **Measure Ref Value** ou bien utiliser la touche de fonction **dB Ref Value** pour saisir une valeur.

Le réglage d'échelle dB concerne uniquement les fonctions de mesure en tension alternative et continue.

Réglage d'échelle dBm



La fonction dBm est logarithmique et compare la puissance fournie à une résistance de référence par rapport à 1 milliwatt :

$$\text{dBm} = 10 \times \log_{10} (\text{mesure}^2 / \text{résistance de référence} / 1 \text{ mW})$$

La valeur de résistance de référence (**Ref R**) peut être 50, 75, 93, 110, 124, 125, 135, 150, 250, 300, 500, 600 (valeur par défaut), 800, 900, 1 000, 1 200 ou 8 000 Ω. Appuyez sur **Ref R** et utilisez les touches fléchées vers le haut et bas du panneau avant pour effectuer votre sélection.

Le réglage d'échelle dBm concerne uniquement les fonctions de mesure en tension alternative et continue.

% de réglage d'échelle



La touche % effectue un calcul de variation en pourcentage. Le résultat est la variation en pourcentage de la mesure par rapport à la valeur de référence :

$$\text{Résultat} = ((\text{Mesure} - \text{Référence}) / \text{Référence}) * 100.$$

Appuyez sur **Measure Reference** pour utiliser la première mesure comme valeur de référence ou sur **Ref Value** pour saisir la valeur de référence.

Le % de réglage d'échelle s'applique à toutes les fonctions de mesure, à l'exception de Rapport, Continuité et Diode.

Réglage d'échelle Mx-B



Pour le réglage d'échelle Mx-B, le résultat est la mesure multipliée par la valeur de **Gain (M)**, moins la valeur de **Offset (B)**.

La touche de fonction **User Units** vous permet de spécifier le libellé alphanumérique personnalisé de quatre caractères maximum (par exemple, RPM ou °C) pour les mesures Mx-B à l'échelle.

Le réglage d'échelle Mx-B s'applique à toutes les fonctions de mesure, à l'exception de Rapport, Continuité et Diode.

Voir également

[Math \(Opération mathématique\) - Introduction](#)

[Null \(Valeur de référence\)](#)

[Statistics \(Statistiques\)](#)

[Limits \(Limites\)](#)

Math (Opération mathématique) - Smoothing (Lissage)

(34465A/70A uniquement) La fonction de lissage est un filtre à moyenne flottante (boxcar) qui permet de réduire le bruit aléatoire dans les mesures. Elle vise à calculer la moyenne des variations mineures observées dans les mesures. Les variations plus importantes provoquent une réinitialisation du filtre.

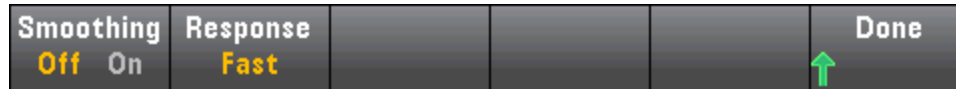

Appuyez sur **Response** pour sélectionner **Slow** (100 lectures), **Medium** (50 lectures) ou **Fast** (10 lectures) afin de calculer la moyenne.



Le filtre de lissage s'applique à toutes les fonctions de mesure, à l'exception de Digitizing (Numérisation), Data Logging (Enregistrement de données), Continuity (Continuité), Diode et Probe Hold (Maintien de sonde).

Le filtre de lissage démarre à l'état réinitialisé (aucune lecture dans le filtre) et est réinitialisé si la fonction de mesure est changée ou si une mesure est considérablement supérieure à la moyenne actuelle. Une fois que le filtre est réinitialisé, la mesure est la moyenne de toutes les mesures jusqu'à la réponse spécifiée (10, 50, 100). À ce stade, la mesure est la moyenne flottante des 10 (rapide), 50 (moyenne) ou 100 (lente) dernières mesures. Une pondération uniforme est appliquée à toutes les mesures de la moyenne.

L'icône **Filter** (en haut, à droite de l'écran) indique la variation de mesures, la quantité de mesures autorisées dans le filtre et l'heure à laquelle le filtre est réinitialisé comme suit :

- Une variation de mesure trop importante provoque systématiquement la réinitialisation du filtre et l'icône de filtre est surlignée en jaune (**Filter**).
- Lorsque le filtre se remplit avec des mesures qui se trouvent dans la variation autorisée par rapport aux mesures déjà présentes dans le filtre, l'icône de filtre passe progressivement au vert de gauche à droite (**Filter** -> **Filter**).
- Une mesure unique supérieure à la variation autorisée par rapport aux mesures présentes dans le filtre entraîne une réinitialisation du filtre et la mise en surbrillance de l'icône de filtre en jaune (**Filter**).
- Si toutes les mesures sont comprises dans la variation autorisée par rapport aux mesures présentes dans le filtre, l'icône de filtre est surlignée en vert (**Filter**).

Math (Opération mathématique) - Statistics (Statistiques)

Lorsque l'instrument effectue des mesures, il calcule automatiquement les statistiques sur ces mesures.

Menus du panneau avant

Le menu Statistics (Statistiques) est accessible à partir de la troisième touche de fonction du menu [Math].



REMARQUE Pour un affichage précis des statistiques des mesures en courant alternatif en mode Panneau avant, vous devez utiliser le retard de déclenchement manuel par défaut ([Acquire] > Delay Man).

La première touche de fonction de ce menu (illustrée ci-dessous) permet de masquer ou d'afficher les statistiques sous l'écran de données (nombre, barre de mesure, diagramme de tendance (non disponible sur le modèle 34461A) ou histogramme).

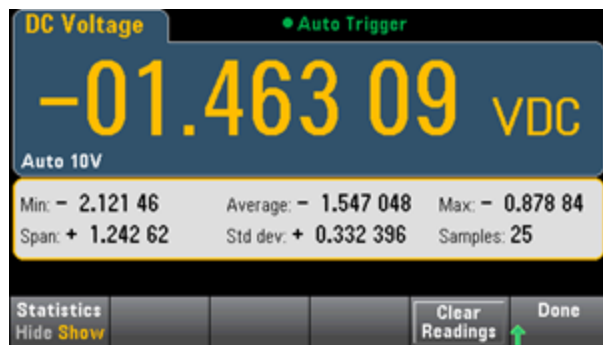

L'écart moyen et l'écart-type ne sont pas affichés si le réglage d'échelle dB ou dBm est utilisé.

Remarques

- La valeur d'intervalle (**Span**) correspond à la valeur maximale (**Max**) moins la valeur minimale (**Min**).
- Appuyez sur **Clear Readings** pour effacer la mémoire de mesures et relancer le calcul des statistiques.

Voir également

[Math \(Opération mathématique\) - Introduction](#)

[Null \(Valeur de référence\)](#)

[dB/dBm Scaling \(Réglage d'échelle dB/dBm\)](#)

[Limits \(Limites\)](#)

Math (Opération mathématique) - Limits (Limites)

La vérification des limites indique le nombre d'échantillons qui ont dépassé les limites spécifiées, et fournit une indication visuelle du moment auquel les limites sont dépassées.

Menus du panneau avant

Le menu Limits (Limites) est accessible à partir du menu **[Math]**.

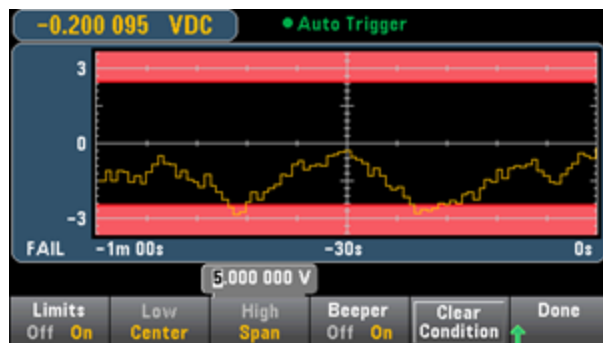

La première touche de fonction permet d'activer ou de désactiver des limites. Les deuxième et troisième touches de fonction spécifient les limites sous forme de valeurs basses et élevées ou d'intervalle autour d'une valeur centrale. Par exemple, une limite basse (**Low**) de -4 V et une limite élevée (**High**) de +7 V équivalent à une valeur centrale (**Center**) de 1,5 V et à un intervalle (**Span**) de 11 V.

La touche de fonction **Beeper** active ou désactive l'avertisseur sonore lorsque les limites sont franchies (elle active ou désactive également l'avertisseur sonore pour les autres fonctions qui utilisent ce dernier : maintien de la sonde, diode, continuité et erreurs). La touche **Clear Condition** redéfinit les marqueurs de limite au vert comme décrit ci-dessous.

Indications de limites

L'écran utilise des couleurs pour indiquer les limites et les dépassements de limites.

Trend Chart (Diagramme de tendance) (34461A/65A/70A uniquement)

La zone limite est indiquée en rouge clair sur le graphique. Les bordures limites sont affichées en vert (illustrées ci-dessous) dès lors que les limites n'ont pas été dépassées.

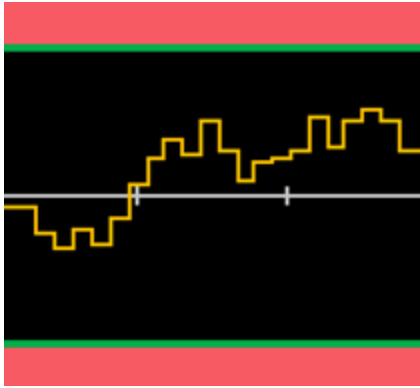

En cas de dépassement d'une limite, la bordure devient rouge. Dans l'image ci-dessous, la bordure supérieure est toujours verte, mais la bordure inférieure est devenue rouge car la ligne de tendance est passée dans la zone limite inférieure.

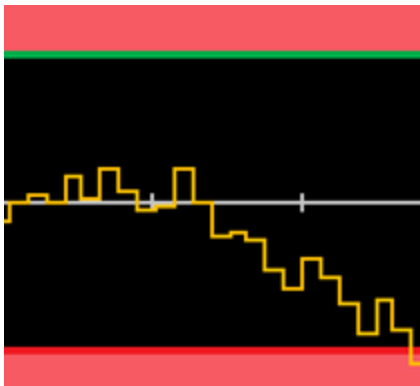

La bordure demeure rouge, même si la ligne de tendance quitte la zone limite. Si la ligne de tendance est comprise dans les limites, vous pouvez redéfinir les bordures au vert en appuyant sur la touche **Clear Condition**.

Caractéristiques et fonctions

Notez également que le numéro de la nouvelle mesure affichée, +09,994 Vcc ci-dessous, indique si la mesure est comprise dans les limites. La limite étant de 10 V, la valeur 9,994 Vcc s'affiche avec l'arrière-plan standard.

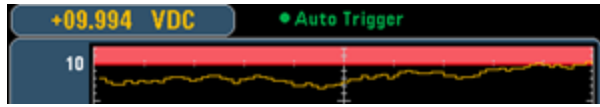

En revanche, la valeur 11,083 Vcc est mise en surbrillance en rouge pour indiquer qu'elle est hors limites.

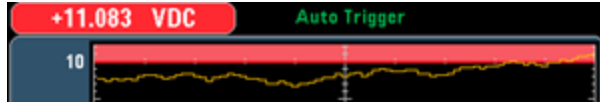

Histogramme

Le même schéma de couleurs s'applique aux histogrammes. Dans l'image ci-dessous, les lignes verticales vertes qui séparent l'arrière-plan d'histogramme noir des zones limites affichées en rouge clair indiquent que les limites n'ont pas été dépassées.

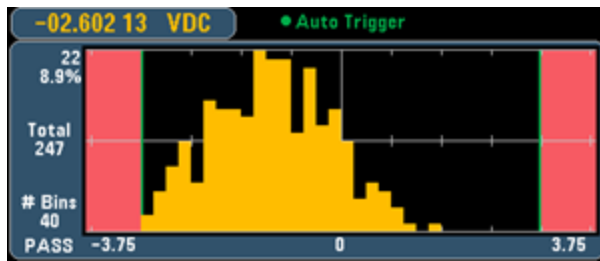

Dans l'image ci-dessous, la bordure limite (gauche) inférieure est rouge, ce qui signifie que la limite inférieure a été dépassée. (La valeur affichée dans l'angle supérieur gauche (-01.68487 Vcc) est comprise dans les limites. Elle n'est donc pas affichée en rouge.)

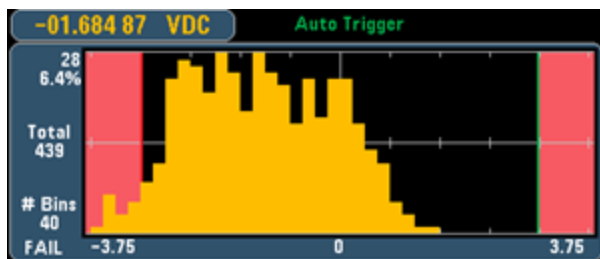

Barre de mesure

La barre de mesure (ci-dessous) utilise le même schéma de couleurs. La bordure limite verte sur la gauche indique que la limite inférieure n'a pas été dépassée, et la bordure limite rouge sur la droite indique que la limite supérieure a été dépassée. Les numéros 0 et 259 sous les zones limites affichées en rouge clair indiquent le nombre de fois que chaque limite a été dépassée, alors que le mot FAIL indique qu'une limite a été dépassée.

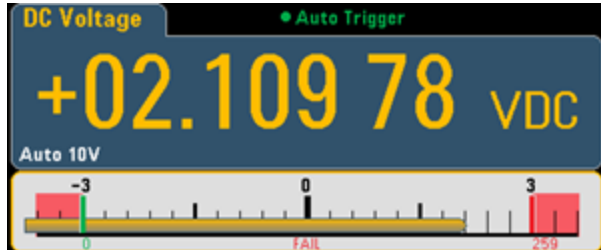

Nombre

La couleur rouge clair (illustrée ci-dessous) indique que la mesure affichée dépasse les limites. L'écran **Number** indique également le nombre de fois que les limites ont été dépassées.

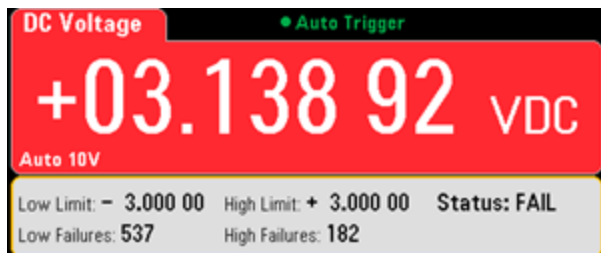

Voir également

[Math \(Opération mathématique\) - Introduction](#)

[Null \(Valeur de référence\)](#)

[dB/dBm Scaling \(Réglage d'échelle dB/dBm\)](#)

[Statistics \(Statistiques\)](#)

Display (Affichage) - Introduction

Par défaut, l'instrument affiche les mesures sous forme numérique. Vous pouvez également sélectionner un affichage Bar Meter (Barre de mesure), Trend Chart (Diagramme de tendance) (34461A/65A/70A uniquement) ou Histogram (Histogramme) :



Pour les affichages Number (Nombre) et Bar Meter (Barre de mesure), de nombreuses fonctions de mesure principales vous permettent d'afficher une mesure secondaire. Pour de plus amples informations, reportez-vous à la section [Mesures secondaires](#).

Sélection de l'affichage



Le fait d'appuyer sur la touche **Utility Display**, puis sur la touche de fonction **Display** vous permet de sélectionner le type d'affichage :



Le tableau suivant récapitule les différents types d'affichages de l'instrument pour chaque mode de mesure.

Mode	Nombre	Barre de mesure	Type d'affichage		Commentaires/Utilisations
			Diagramme de tendance	Histogramme	
Continu	Valeur par défaut à la mise sous tension, mesure présente sur l'écran.	Nombre + diagramme à barres, mesure présente sur l'écran.	Mesures couvrant une période donnée, et affichées sous forme de graphique à déroulement continu (Tendance) ou d'histogramme. Les valeurs de mesure exactes ne sont pas accessibles depuis le panneau avant.		Les données de tendance et d'histogramme sont en affichage seul, les valeurs de mesure individuelles ne sont pas disponibles sur le panneau avant.
Enregistrement de données	Valeur présente sur l'écran. Tous les autres points stockés comme indiqué dans les menus Acquire. Durée restante et autres échantillons affichés dans la partie inférieure.		Diagramme ou graphique renseigné à mesure que les échantillons sont prélevés. Fonctions de zoom/-panoramique et curseurs disponibles pour faciliter la visualisation de chaque mesure.		De série sur les modèles 34465A et 34470A uniquement. Pour plus de détails, voir Mode Enregistrement de données .
Numérisation	Valeur présente sur l'écran. Tous les autres points stockés comme indiqué dans les menus Acquire. Durée restante et autres échantillons affichés dans la partie inférieure.		Diagramme ou graphique rempli à mesure que les échantillons sont prélevés. Fonctions de zoom/-panoramique et curseurs disponibles pour faciliter la visualisation de chaque mesure.		Modèles 34465A et 34470A uniquement, requiert l'option DIG. Optimisé pour l'échantillonnage haut débit. Intervalle d'échantillonnage max. de 100 ms, min. 20 µs. Pour plus de détails, reportez-vous à la section Mode Numérisation .

Pour plus d'informations sur l'un des types d'affichages suivants, cliquez sur un lien ci-dessous :

[Nombre](#)

[Barre de mesure](#)

[Trend Chart \(Diagramme de tendance\) \(34461A/65A/70A uniquement\)](#)

[Histogramme](#)

[Mesures secondaires](#)

Nombre

Par défaut, l'instrument affiche les mesures sous la forme d'un nombre :

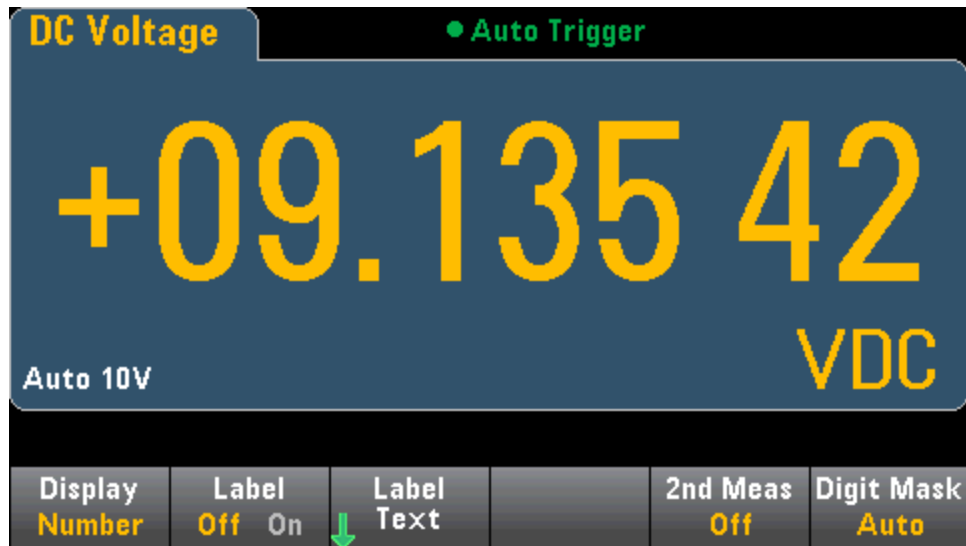

Ajout d'un libellé

La touche de fonction **Label** vous permet d'ajouter un libellé en texte large sur l'écran. Par exemple, vous pouvez utiliser cette touche pour indiquer la mesure actuellement effectuée par le multimètre.

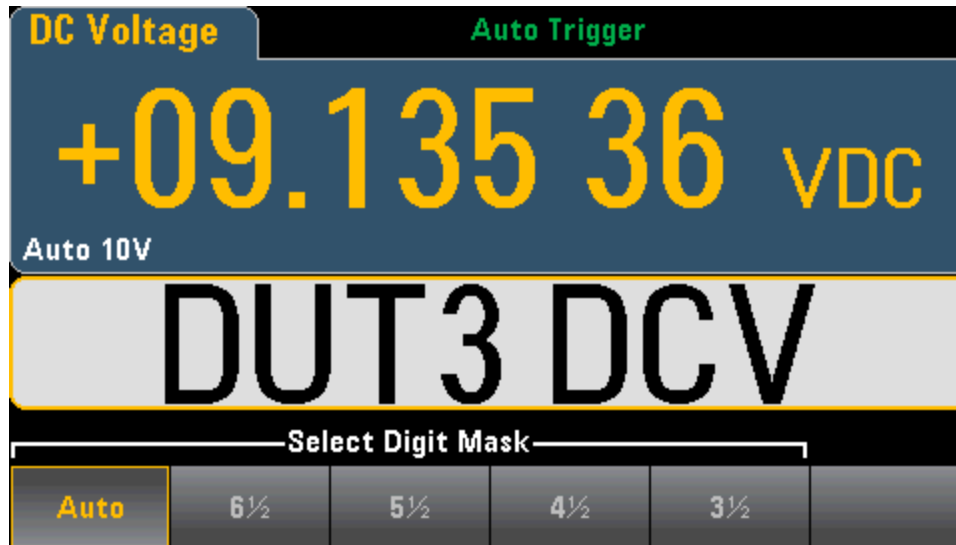

Pour saisir le texte, appuyez sur **Label Text**, et utilisez les touches de fonction et les touches fléchées du panneau avant pour modifier le libellé (ci-dessous). Appuyez ensuite sur **Done**. Notez que la police du libellé est automatiquement réduite pour contenir des libellés plus longs.



Sélection d'une mesure secondaire

Appuyez sur **2nd Meas** pour sélectionner et afficher une mesure secondaire. Par exemple, pour la fonction de mesure en tension continue, vous pouvez sélectionner la fonction de mesure secondaire V CA (Tension alternative), Peak (Crête) ou Pre-Math (Opération mathématique préalable). Lorsque la fonction V CA (Tension alternative) est sélectionnée comme mesure secondaire, l'écran affiche la mesure en tension continue dans la partie supérieure et la mesure en tension alternative dans la partie inférieure :



Pour de plus amples informations sur les mesures secondaires disponibles pour chaque fonction de mesure, reportez-vous à la section [Mesures secondaires](#).

Indication du masquage de chiffres

La touche de fonction Digit Mask permet de spécifier le nombre de chiffres affichés.



Par exemple, l'image suivante contient 6½ chiffres.

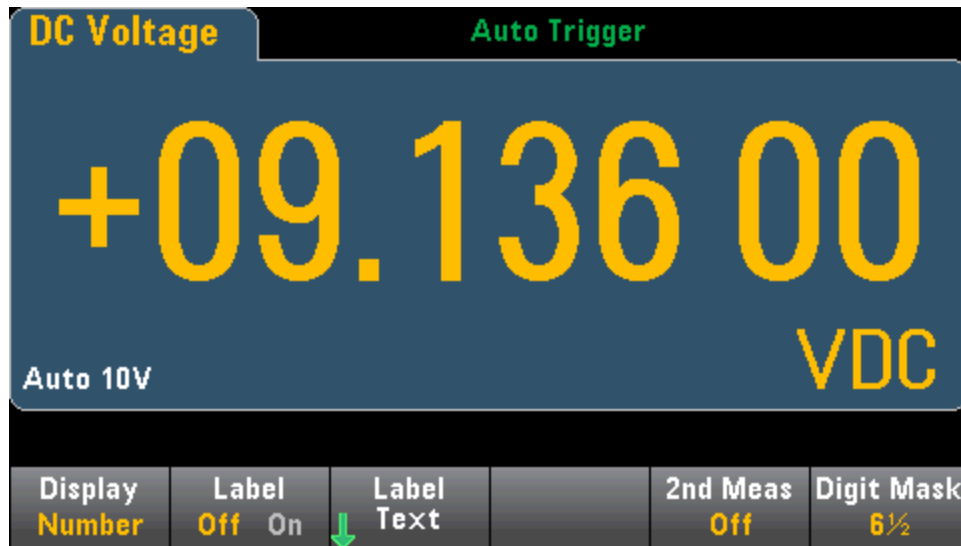

En revanche, cette image montre 4½ chiffres.



La touche de fonction **Auto** indique que le nombre de chiffres affichés dépend d'autres paramètres spécifiques à la fonction, tels que l'ouverture de mesure, définie en nombres de cycles de tension d'alimentation (NPLC). Les mesures sont toujours arrondies ; elles ne sont jamais tronquées.

Caractéristiques et fonctions

Voir également

[Display \(Affichage\) - Introduction](#)

[Barre de mesure](#)

[Trend Chart \(Diagramme de tendance\) \(34461A/65A/70A uniquement\)](#)

[Histogramme](#)

[Mesures secondaires](#)

Barre de mesure

La barre de mesure (ci-dessous) ajoute une barre de déplacement sous l'affichage Number (Nombre) standard.

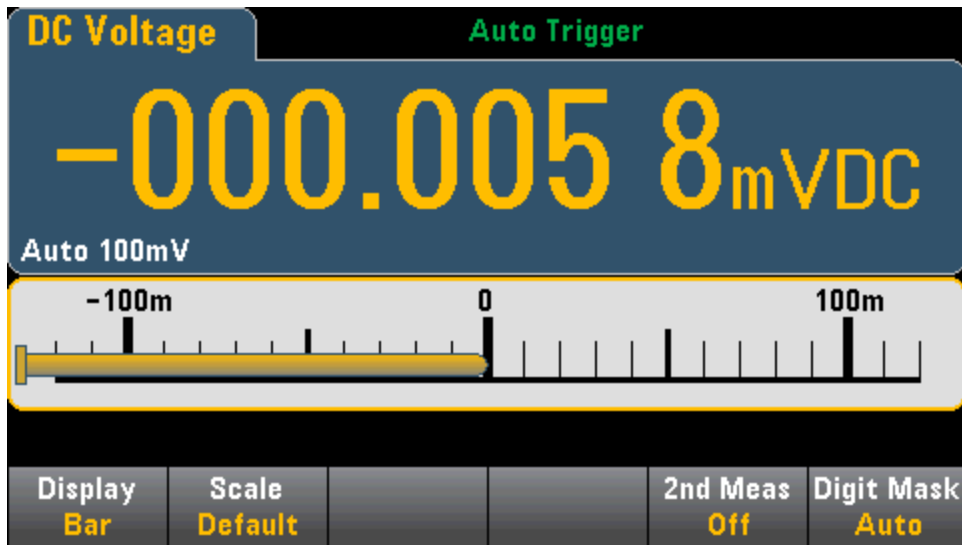

Les touches de fonction **Display** et **Digit Mask** effectuent les mêmes actions que sur l'écran **Number** (Nombre).

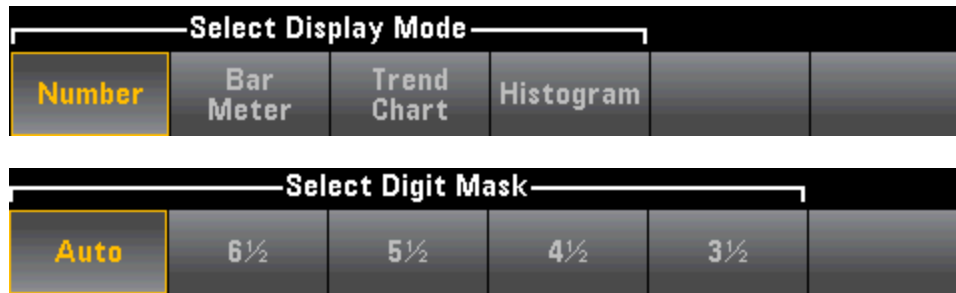

La touche de fonction **Scale** permet de spécifier l'échelle horizontale :



- L'option **Default** définit l'échelle à une valeur égale à la plage de mesure.
- Le paramètre **Manual** vous permet de configurer l'échelle sous forme de valeurs élevée (**High**) et basse (**Low**) ou d'intervalle (**Span**) autour d'une valeur centrale (**Center**). Par exemple, une échelle passant d'une valeur basse (**Low**) de -500Ω à une valeur élevée (**High**) de $1\,000 \Omega$ peut également être spécifiée comme valeur centrale (**Center**) de 250Ω avec un intervalle (**Span**) de $1\,500 \Omega$.



Sélection d'une mesure secondaire

Appuyez sur **2nd Meas** pour sélectionner et afficher une mesure secondaire. Par exemple, pour la fonction de mesure en tension continue, vous pouvez sélectionner la fonction de mesure secondaire V CA (Tension alternative), Peak (Crête) ou Pre-Math (Opération mathématique préalable). Lorsque la fonction V CA (Tension alternative) est sélectionnée comme mesure secondaire, l'écran affiche la mesure en tension continue sous forme numérique dans la partie supérieure, la tension continue dans la barre de mesure et la mesure en tension alternative au-dessus de cette barre :

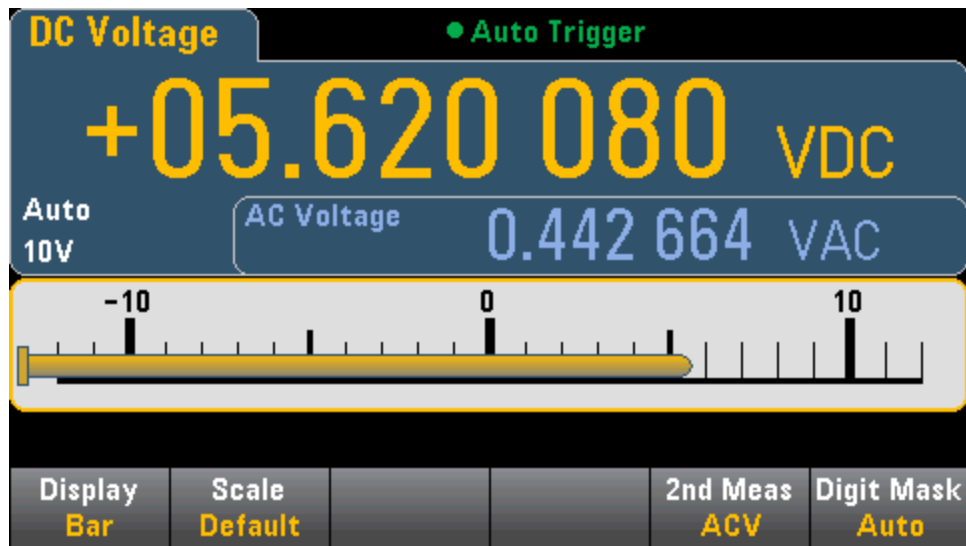

Pour de plus amples informations sur les mesures secondaires disponibles pour chaque fonction de mesure, reportez-vous à la section [Mesures secondaires](#).

Voir également

[Display \(Affichage\) - Introduction](#)

[Nombre](#)

[Trend Chart \(Diagramme de tendance\) \(34461A/65A/70A uniquement\)](#)

[Histogramme](#)

[Mesures secondaires](#)

Diagramme de tendance (Mode de mesure continue)

Cette rubrique décrit le comportement du diagramme de tendance pour les modèles 34461A/65A/70A uniquement, en mode de mesure continue. Le diagramme de tendance n'est pas disponible pour le modèle 34460A.

Pour sélectionner le diagramme de tendance, appuyez sur [**Display**], puis sur la touche de fonction **Display** :



En mode de mesure continue, le diagramme de tendance affiche les tendances de données au fil du temps :

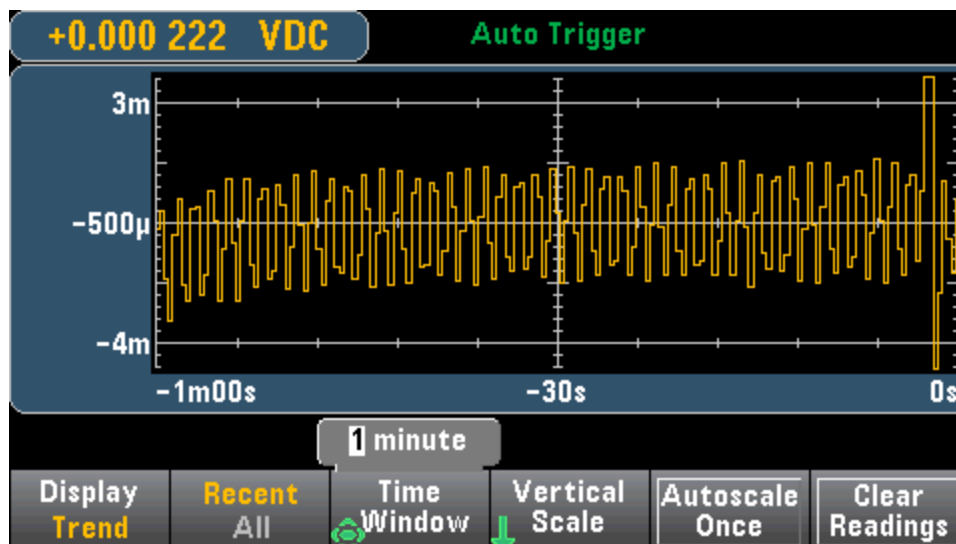

Les données sont recueillies et affichées dans des colonnes de pixels comme décrit ci-dessous.

Recent/All (Récent/Tout)

La touche de fonction **Recent/All** affiche toutes les données du diagramme de tendance (**All**) ou uniquement les données les plus récentes (**Recent**). Aucune de ces options n'entraîne l'effacement de la mémoire de mesures.

En mode Tout, le diagramme de tendance affiche toutes les mesures effectuées et se construit de gauche à droite. Une fois l'écran renseigné, les données sont compressées sur le côté gauche de l'écran car de nouvelles données sont ajoutées sur le côté droit de l'écran.

En mode Récent, le diagramme de tendance affiche les données prélevées au cours d'une période donnée. Pour les modèles 34465A/70A, ce temps est sélectionné à l'aide de la touche de fonction **Time Window** (1 minute à 1 heure). Pour les modèles 34461A/70A, ce temps est fixé à 1 minute, et aucune touche de fonction **Time Window** n'est disponible. La modification de ce paramètre entraîne l'effacement du diagramme de tendance, mais pas celui de la mémoire de mesures ou des données statistiques ou d'histogramme.

Colonnes de pixels

La zone d'affichage du diagramme de tendance présente une largeur de 400 pixels et une hauteur de 147 pixels. Une colonne de pixels comporte une largeur de 1 pixel et une hauteur de 147 pixels. Chaque colonne de pixels du diagramme de tendance affiché représente 1/400 de la valeur du paramètre Time Window. Le paramètre Time Window détermine donc la durée représentée par chaque colonne de pixels comme suit :

- 1 minute = 150 mS par colonne de pixels - ce temps est utilisé pour le mode Récent du modèle 34461A et le mode Tout (34461A/65A/70A)
- 5 minutes = 750 mS par colonne de pixels (34465A/70A uniquement)
- 10 minutes = 1,5 S par colonne de pixels (34465A/70A uniquement)
- 30 minutes = 4,5 S par colonne de pixels (34465A/70A uniquement)
- 1 heure = 9 S par colonne de pixels (34465A/70A uniquement)

Si la fréquence de lecture est supérieure au temps pour chaque colonne de pixels, la colonne représente plusieurs lectures. Dans ce cas, le diagramme de tendance trace une ligne verticale dans chaque colonne de pixels en affichant les valeurs de mesure maximale à minimale pendant cette période :

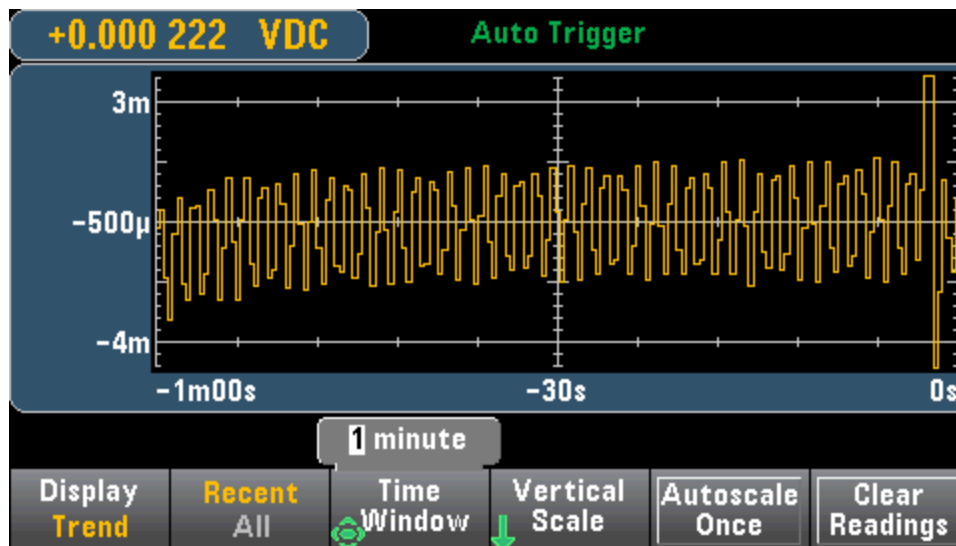

Si la fréquence de lecture est inférieure au temps pour chaque colonne de pixels, certaines colonnes peuvent ne représenter aucune lecture. Dans ce cas, le diagramme de tendance se poursuit avec une ligne horizontale en travers du pixel :

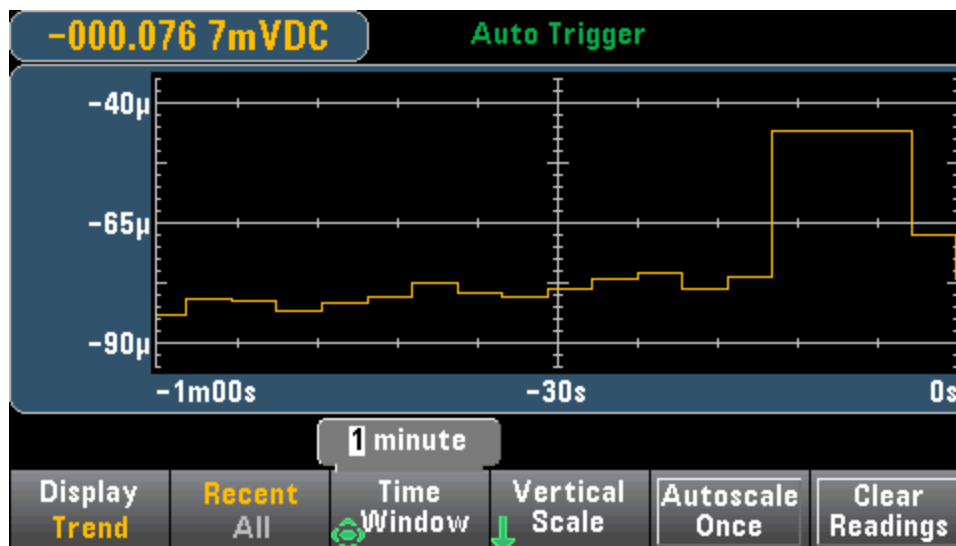

Réglage d'échelle

La touche de fonction **Vertical Scale** indique la façon dont l'échelle verticale active est déterminée.



Appuyez sur **Vertical** pour modifier le réglage d'échelle :



- L'option **Default** définit l'échelle à une valeur égale à la plage de mesure.
- Le paramètre **Auto** règle automatiquement l'échelle afin qu'elle s'adapte correctement à la ligne actuellement affichée à l'écran.
- Le paramètre **Manual** vous permet de configurer l'échelle sous forme de valeurs élevée (**High**) et basse (**Low**) ou d'intervalle (**Span**) autour d'une valeur centrale (**Center**). Par exemple, une limite basse (**Low**) de 0 V et une limite élevée (**High**) de 5 V équivalent à une valeur centrale (**Center**) de 2,5 V et à un intervalle (**Span**) de 5 V.



Si vous avez activé des limites, la touche de fonction (**Limits**) apparaît également. Cette dernière définit l'échelle verticale en fonction des limites.

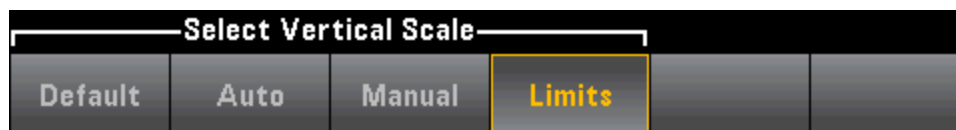

Voir également

[Display \(Affichage\) - Introduction](#)

[Nombre](#)

[Barre de mesure](#)

[Histogramme](#)

Diagramme de tendance (Modes Numérisation et Enregistrement de données)

Cette rubrique concerne uniquement les multimètres numériques 34465A/70.

Diagramme de tendance - Mode Numérisation

Lorsque le multimètre numérique 34465A/70A est en mode Numérisation (option DIG requise), les commandes Zoom, Pan et Cursors du diagramme de tendance sont disponibles. Pour accéder au mode Numérisation, appuyez sur la touche de fonction [Acquire] > Acquire > Digitize.

Pour sélectionner le diagramme de tendance, appuyez sur [Display], puis sur la touche de fonction Display :



En mode Numérisation, les touches de fonction suivantes du diagramme de tendance sont disponibles :

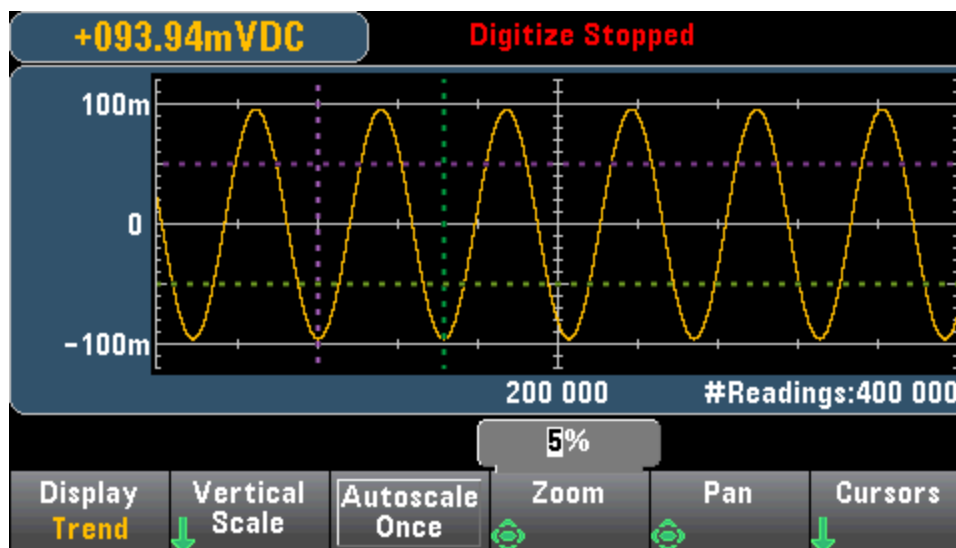

Zoom - Définit le pourcentage d'agrandissement de l'axe horizontal. Appuyez sur **Zoom** et utilisez les touches fléchées vers le haut/bas pour sélectionner le facteur d'agrandissement, en pourcentage. 100 % est le facteur d'agrandissement maximal avec un maximum d'une lecture affichée par colonne de pixels d'affichage. L'écran présente une largeur de 400 pixels. Vous pouvez sélectionner un pourcentage de zoom de 1 %, 2 %, 5 %, 10 %, 20 %, 50 % ou 100 %. Par exemple, le graphique ci-dessus affiche un zoom de 5 % alors que le graphique ci-dessous affiche le même signal avec un zoom de 100 % :

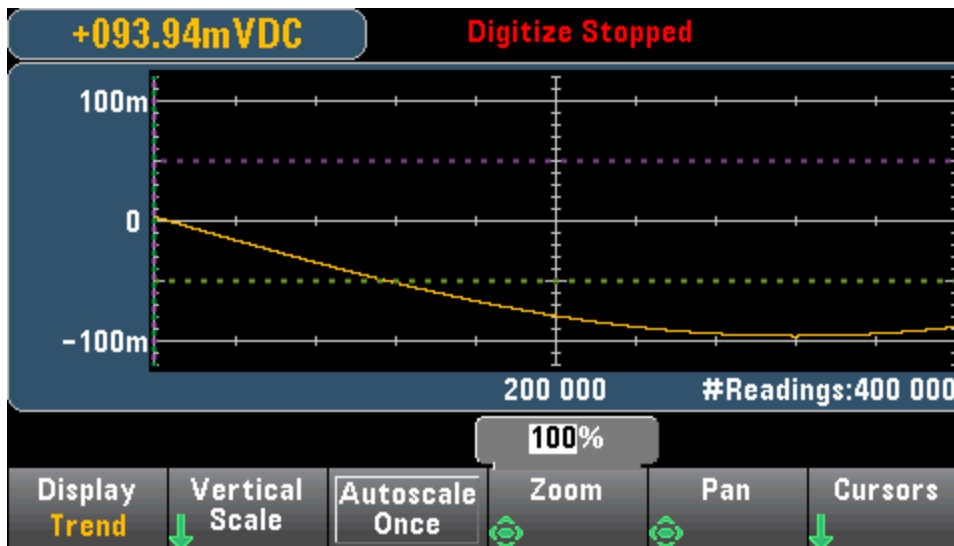

Pan - Détermine la lecture en mémoire affichée au centre de l'écran. Utilisez la touche fléchée vers le haut ou vers le bas pour augmenter le nombre de lectures affichées. Les données du graphique sont alors déplacées vers la gauche. Utilisez la touche fléchée vers le haut ou la gauche pour réduire le nombre de lectures affichées. Les données du graphique sont alors déplacées vers la droite.

Appuyez sur une touche fléchée et relâchez-la pour déplacer le curseur d'un pixel d'affichage. Maintenez une touche fléchée enfoncée pour déplacer le curseur par incréments de 20 pixels. Le nombre de lectures représentées par pixel varie selon le pourcentage de zoom.

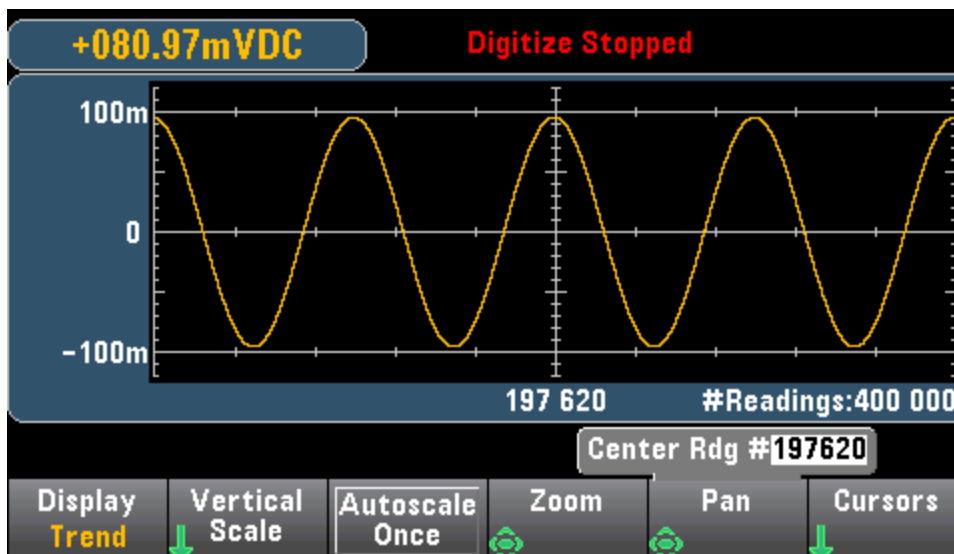

Conseil : Effectuez un zoom à 100 % pour effectuer un panoramique d'une mesure à la fois. Après avoir sélectionné une mesure, vous pouvez réduire le zoom, si nécessaire, pour visualiser le signal environnant.

Cursors - Affiche et contrôle les curseurs X1, X2, Y1, Y2 et de suivi (indiqués sous forme de lignes) sur le diagramme de tendance.

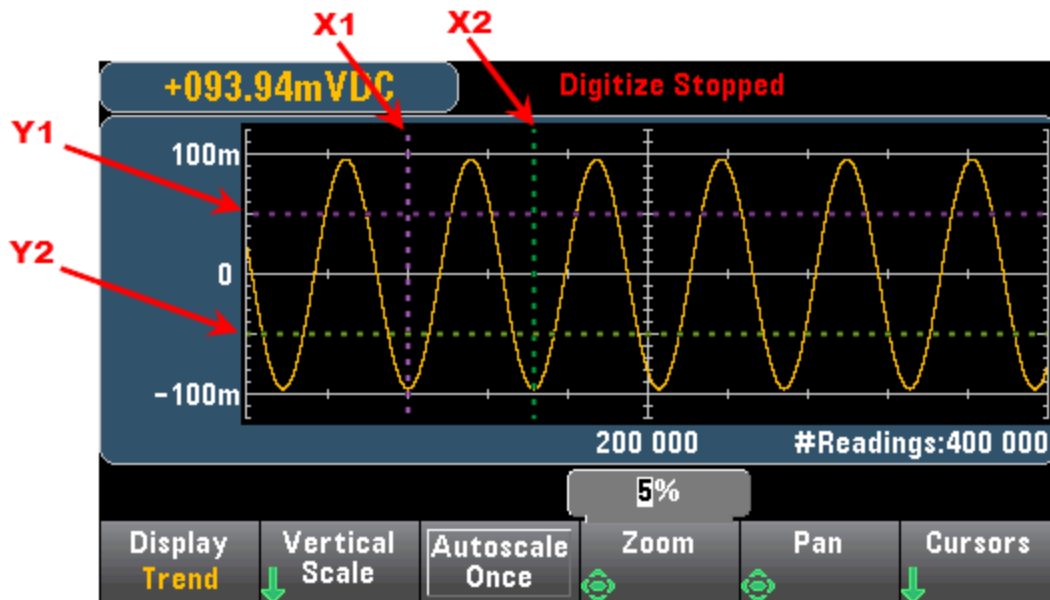

Les curseurs X sont des lignes verticales positionnées le long de l'axe d'échantillonnage ou de temps. Utilisez la touche fléchée vers le haut ou la droite pour déplacer le curseur vers la droite et la touche fléchée vers le bas ou la gauche pour déplacer le curseur vers la gauche. Appuyez sur une touche fléchée et relâchez-la pour déplacer le curseur d'un pixel d'affichage. Maintenez une touche fléchée enfoncée pour déplacer le curseur par incréments de 10 pixels. Les curseurs Y sont des lignes horizontales positionnées le long de l'axe (amplitude) de mesure de la mesure sélectionnée (DCV ou DCI). Utilisez les touches fléchées vers la gauche ou vers la droite pour sélectionner un chiffre d'amplitude affiché au-dessus de la touche de fonction Y1 ou Y2. Vous pouvez ensuite utiliser les touches fléchées vers le haut ou le bas pour augmenter/réduire ce chiffre et déplacer le curseur vers le haut ou le bas en fonction de cette valeur. Les curseurs X1 et Y1 sont violets ; les curseurs X2 et Y2 sont verts.

Appuyez sur **Cursors** > **Cursors** pour afficher les options suivantes :



X Only – Affiche uniquement les curseurs X1 et X2. Dans ce mode, les touches de fonction suivantes sont disponibles :

- **X1** - Utilisez les touches fléchées pour sélectionner le curseur X1.
- **X2** - Utilisez les touches fléchées pour sélectionner le curseur X2.
- **ΔX Lock** - Lorsque cette option est **activée**, les curseurs X sont maintenus à une distance fixe l'un de l'autre lorsque l'un des curseurs est déplacé.

Y Only – Affiche uniquement les curseurs Y1 et Y2. Dans ce mode, les touches de fonction suivantes sont disponibles :

- **Y1** - Utilisez les touches fléchées pour sélectionner le curseur Y1.
- **Y2** - Utilisez les touches fléchées pour sélectionner le curseur Y2.

- **ΔX Lock** - Lorsque cette option est **activée**, les curseurs Y sont maintenus à une distance fixe l'un de l'autre lorsque l'un des curseurs est déplacé.
- **Place Yn on Screen** - Appuyez sur **Y1** ou sur **Y2**, suivi de cette touche de fonction pour définir le curseur sur une valeur qui la met en valeur sur le diagramme.

X and Y - Affiche les curseurs X1, X2, Y1 et Y2. Dans ce mode, les touches de fonction suivantes sont disponibles :

- **X1** - Utilisez les touches fléchées pour sélectionner le curseur X1.
- **X2** - Utilisez les touches fléchées pour sélectionner le curseur X2.
- **Y1** - Utilisez les touches fléchées pour sélectionner le curseur Y1.
- **Y2** - Utilisez les touches fléchées pour sélectionner le curseur Y2.

Track Rdnq at X - Sélectionnez deux mesures, par numéro de mesure à l'aide des touches de fonction X1 et X2 pour afficher les valeurs X (temps) et Y (amplitude) de chaque mesure, ainsi que les valeurs X delta et Y delta.

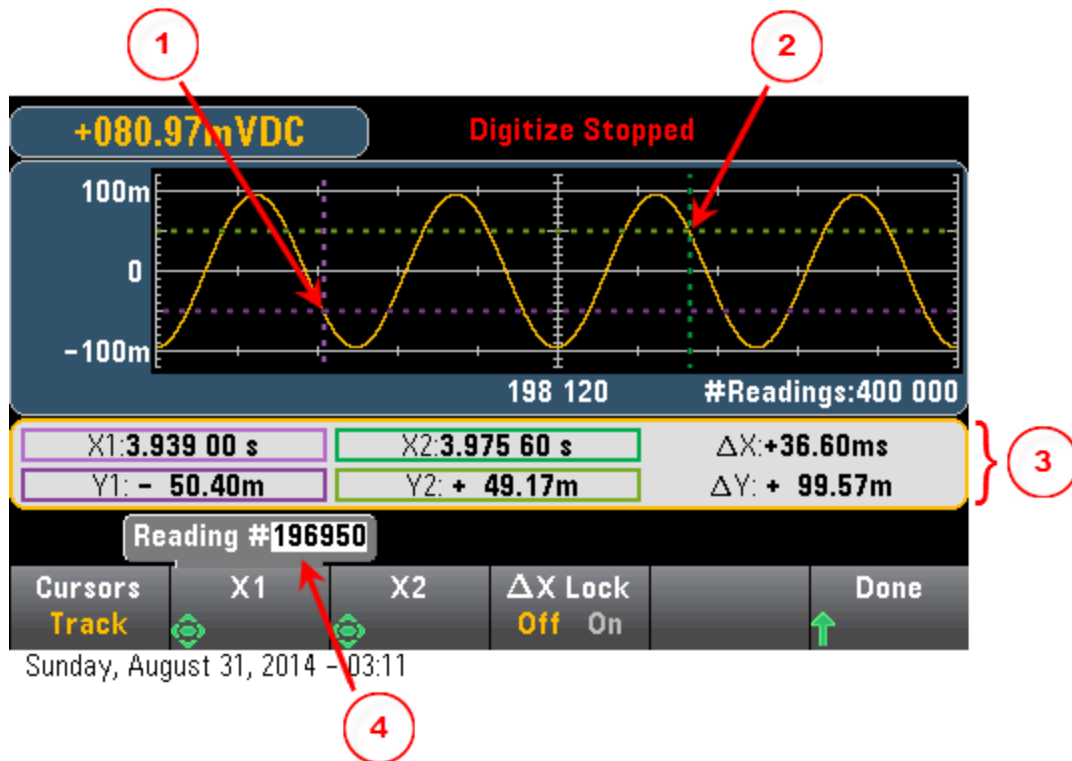

Dans le graphique ci-dessus :

- 1 Le curseur Y1 suit la position du curseur X1.
- 2 Le curseur Y2 suit la position du curseur X2.
- 3 Informations sur le temps de curseur et l'amplitude ΔX , ΔY .

- 4 Appuyez sur Z1 et X2 pour afficher le numéro de mesure.

Ces touches de fonction sont disponibles pour le mode **Track Rdnng at X** :

- **X1** - Utilisez les touches fléchées pour sélectionner le curseur X1.
- **X1** - Utilisez les touches fléchées pour sélectionner le curseur X2.
- **ΔX Lock** - Lorsque cette option est **activée**, les curseurs X sont maintenus à une distance fixe l'un de l'autre lorsque l'un des curseurs est déplacé.

Conseil : Pour enregistrer les données X et Y et les données X et Y delta sous forme de capture d'écran, effectuez une capture d'écran de l'IU Web, et non de l'utilitaire de capture d'écran du panneau avant.

Diagramme de tendance - Mode Enregistrement de données

Cette rubrique concerne uniquement les multimètres numériques 34465A/70 et l'enregistrement de données est standard pour ces instruments. Pour de plus amples informations sur l'enregistrement de données, reportez-vous à la section **Enregistrement de données**.

Lorsque le multimètre numérique est en mode Enregistrement de données, les commandes Zoom, Pan et Cursors du diagramme de tendance sont disponibles. Pour accéder au mode Enregistrement de données, appuyez sur **[Acquire] Acquire > Data Log**.

Pour sélectionner le diagramme de tendance, appuyez sur **[Display]**, puis sur la touche de fonction **Display** :



En mode Enregistrement de données, le comportement du diagramme de tendance varie selon que vous enregistrez les données dans la mémoire de l'instrument ou dans des fichiers.

Enregistrement de données en mémoire

Lors de l'enregistrement de données en mémoire, le diagramme de tendance associe chaque mesure à un point dans une colonne de pixels, trace une ligne entre plusieurs points dans chaque colonne, et trace une ligne de la dernière mesure d'une colonne vers la première lecture de la colonne suivante.

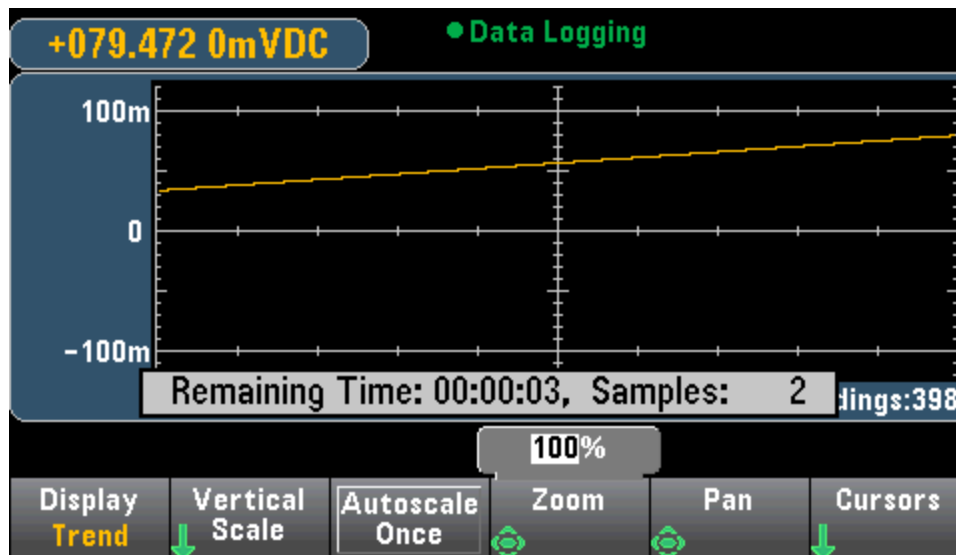

Lors de l'enregistrement de données en mémoire, les commandes Zoom, Pan et Cursors sont disponibles et fonctionnent comme décrit ci-dessus dans la section Numérisation.

Enregistrement de données dans des fichiers

Lors de l'enregistrement de données dans un fichier, le diagramme de tendance se comporte de manière similaire à celle du mode de mesure continue. En effet, le nombre de lectures affichées par colonne de pixels varie selon la vitesse de lecture et la fenêtre de temps sélectionnée.

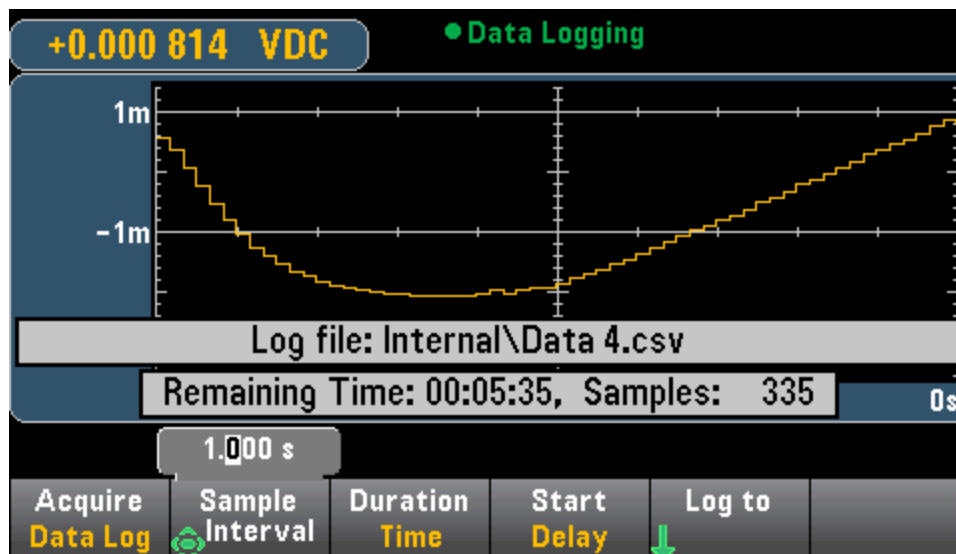

Les commandes Zoom, Pan et Cursors ne sont pas disponibles lors de l'enregistrement des données dans des fichiers. Pour de plus amples informations, reportez-vous à la section [Diagramme de tendance \(Mode de mesure continue\)](#).

Caractéristiques et fonctions

Voir également

[Display \(Affichage\) - Introduction](#)

[Diagramme de tendance \(Mode de mesure continue\)](#)

[Nombre](#)

[Barre de mesure](#)

[Histogramme](#)

Histogramme

L'histogramme présente des données de mesure sous la forme d'une représentation graphique de la distribution des données de mesure. Les données sont regroupées en cases, représentées par des barres verticales dans l'affichage de l'histogramme.

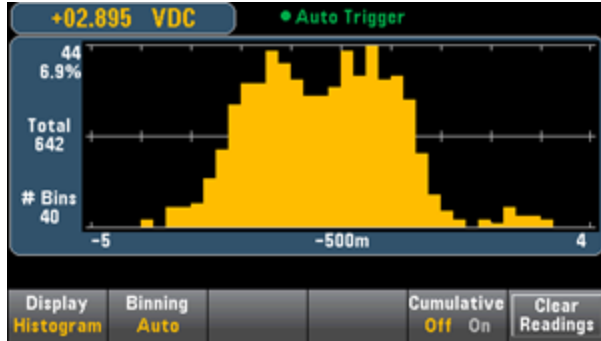

REMARQUE La commutation automatique de plage peut affecter de façon négative l'affichage de l'histogramme lors de la mesure de signaux répétitifs s'étendant sur plusieurs plages. Pour éviter cela, sélectionnez une plage de mesure fixe lors de l'utilisation de l'affichage histogramme.

Sélection de l'affichage



Le fait d'appuyer sur la touche **Display**, puis sur la touche de fonction **Display** vous permet de sélectionner le type d'affichage :



Binning (Répartition en classes)

La touche de fonction **Binning** vous permet de laisser à l'instrument le contrôle du mode de répartition en classes de l'histogramme (binning automatique) ou de spécifier manuellement les paramètres de binning à l'aide de la touche de fonction **Bin Settings**. Toute modification du paramètre de binning ou permutation entre un binning automatique ou manuel entraîne automatiquement la réinitialisation de l'histogramme avec de nouvelles données. Sur les modèles 34461A/65A/70A, ce paramètre permet également de réinitialiser le diagramme de tendance.



Dans le cas d'un binning automatique (**Binning Auto**), l'algorithme commence par réajuster continuellement l'étendue de l'histogramme sur les mesures reçues, entraînant ainsi un nouveau binning des données chaque fois qu'une nouvelle valeur est située en dehors de la plage actuelle. Après avoir acquis

un grand nombre de mesures, une nouvelle mesure hors de la plage engendre la compression des cases selon un facteur de deux de sorte que la nouvelle plage de cases couvrira la nouvelle mesure. Le nombre de cases indiqué est une fonction du nombre de mesures reçues : 0 à 100 mesures = 10 cases, 101 à 500 mesures = 20 cases, 501 à 1000 cases = 40 cases, 1 001 à 5 000 mesures = 100 cases, 5 001 à 10 000 mesures = 200 cases, >10 000 mesures = 400 cases. Si le paramètre NPLC est < 1 PLC, ou si le temps d'ouverture (modèles 34465A/70A uniquement) est < 20 mS, le nombre maximal de cases est de 100.

Dans le cas d'un binning manuel (**Binning Manual**), vous pouvez définir 10, 20, 40, 100, 200 ou 400 cases. Vous pouvez spécifier la plage de cases sous forme de valeurs basse (**Low**) et élevée (**High**), ou d'intervalle (**Span**) autour d'une valeur centrale (**Center**). Par exemple, la plage d'histogramme illustrée ci-dessous (entre -5 et 4 V) peut être spécifiée sous la forme d'une valeur basse (**Low**) de -5 V et d'une valeur élevée (**High**) de 4 V, ou d'une valeur centrale (**Center**) de -0,5 V et d'un intervalle (**Span**) de 9 V.

La touche de fonction **Outer Bins** affiche deux cases supplémentaires pour les mesures supérieures et inférieures à la plage de cases. Par exemple, cette image illustre le réglage de la touche de fonction **Outer Bins** sur **Off**.

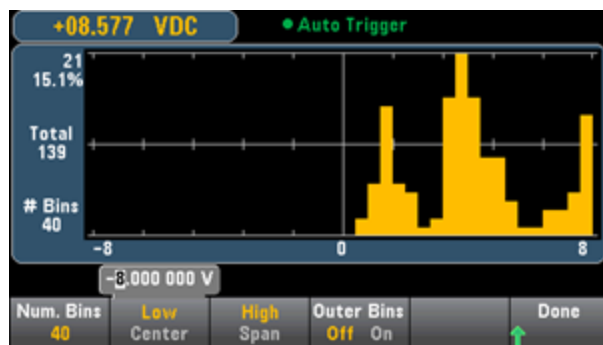

Dans l'image ci-dessous, les cases externes sont ajoutées à l'écran. Le nombre relativement important de mesures au-dessus de la plage de cases (barre cyan) provoque un rétrécissement des barres dans la plage de cases.

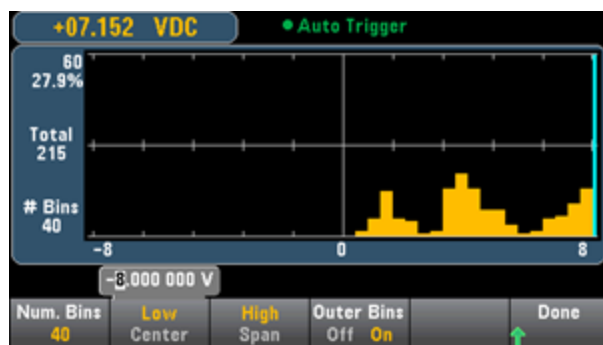

Le menu principal de l'histogramme inclut une touche de fonction **Cumulative** qui permet de masquer ou d'afficher une ligne représentant la fonction de distribution cumulative des données de l'histogramme. Notez que cette ligne représente *toutes* les données uniquement lorsque les cases extérieures sont affichées. Si les cases externes ne sont pas visibles, les données correspondantes ne sont pas représentées sur la ligne. La ligne de distribution cumulative est toujours comprise entre 0 et 100 % sur l'échelle verticale, quelle que soit l'échelle de l'histogramme.

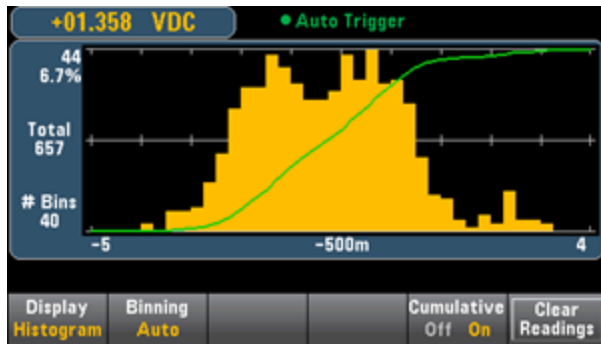

Le dernier bouton du menu d'histogramme, **Clear Readings**, permet d'effacer la mémoire de mesures et de démarrer un nouvel histogramme.

Données de l'histogramme

Le graphique ci-dessous présente un histogramme des mesures de fréquence. Les données sont affichées sur le côté gauche de l'histogramme. Le graphique ci-dessous présente les mesures, en partant du haut à gauche :

- **3.011 06 kHz** - Présentent la valeur de mesure.
- **48** - Nombre d'échantillons dans la case la plus grande.
- **19.0%** - Pourcentage d'échantillons dans la case la plus grande.
- **Total 253** - Nombre total d'échantillons.
- **# Bins 20** - Nombre total de cases.
- **0, 2.5k, 5k** - (Sous l'histogramme) Plage de valeurs de fréquence.

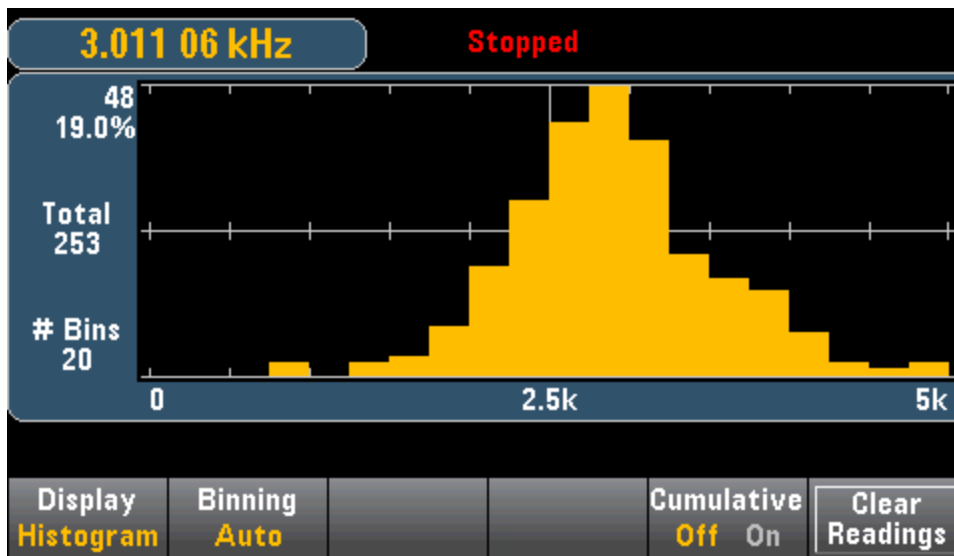

Courseurs (modèles 34465A/70A uniquement)

Appuyez sur la touche de fonction **Cursors** (modèles 34465A/70A uniquement) pour afficher les curseurs de l'histogramme.



Les curseurs de l'histogramme sont spécifiés sous forme de numéros d'intervalle et affichent la plage de valeurs couvertes par ces intervalles, le nombre et le pourcentage du total. Le nombre total et le pourcentage du total, ainsi que la gamme de mesures couvertes, entre les intervalles du curseur, sont également affichés. Dans le graphique ci-dessous, le curseur B1 (lignes verticales violettes) est positionné sur le numéro de case 10 et le curseur B2 (lignes verticales vertes) est positionné sur le numéro de case 14 (numéro de case affiché au-dessus de la touche de fonction **B1**). Les informations sur les cases du curseur B1 sont affichées dans la zone violette, les informations sur les cases du curseur B2 sont affichées dans la zone verte. Par exemple, les informations visibles dans la zone B1 dans le graphique ci-dessous sont les suivantes :

- **2,250 00 k à 2,500 00k** - Plage de valeurs de mesure de fréquence pour cette case.
- **#29** - Nombre d'échantillons dans cette case.
- **11,5 %** - Pourcentage du nombre total d'échantillons dans cette case.

Les données comprises entre les curseurs B1 et B2, notamment les données contenues dans les cases B1 et B2, sont affichées à droite des zones violettes et vertes. Dans le graphique ci-dessous :

- **Intervalle** - Plage de mesure couverte de B1 à B2.
- **#178** - Nombre d'échantillons de B1 à B2.
- **70,4 %** - Pourcentage du nombre total d'échantillons de B1 à B2.

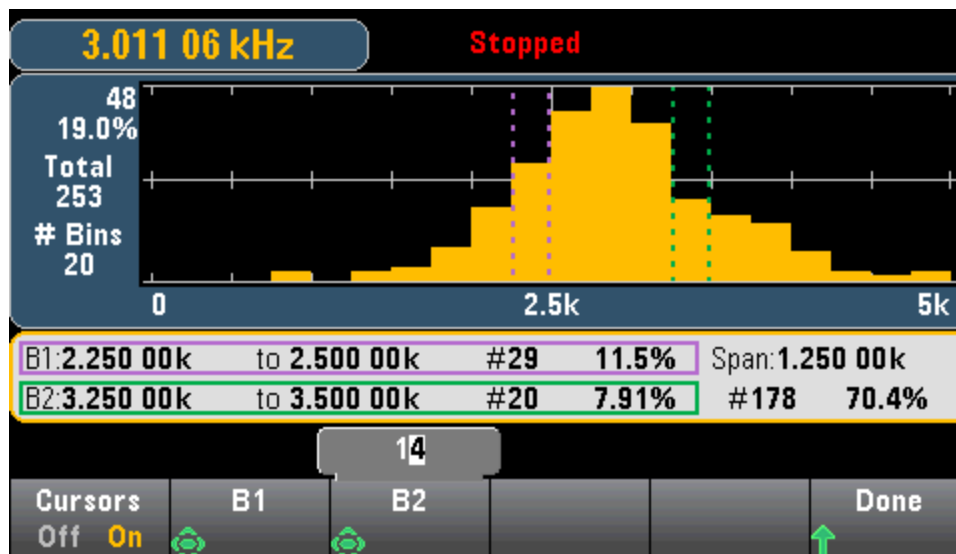

Lorsque les cases externes sont affichées (en cas d'utilisation d'un binning manuel), une valeur de curseur nulle indique le nombre marginal sous la plage de l'histogramme, alors que la valeur un + le nombre d'intervalles indique le nombre marginal au-dessus de la plage de l'histogramme.

Histogramme avec statistiques

L'affichage des statistiques (**Shift > Math > Statistics**) est particulièrement utile pour l'affichage de l'histogramme. Par exemple, dans le graphique ci-dessous, la ligne bleue épaisse correspond à la

moyenne, chaque ligne bleue épaisse représentant un écart-type de la moyenne.

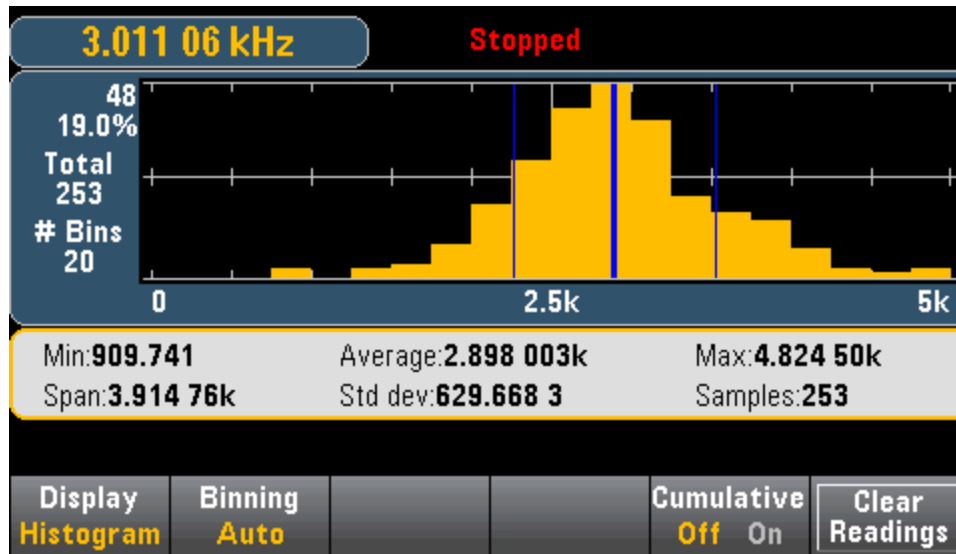

Voir également

[Display \(Affichage\) - Introduction](#)

[Nombre](#)

[Barre de mesure](#)

[Trend Chart \(Diagramme de tendance\) \(34461A/65A/70A uniquement\)](#)

Menu Utility (Utilitaire) - Introduction

La touche **[Utility]** correspond à la touche **[Display]** combinée à la touche Shift :



La touche **[Utility]** permet d'effectuer les actions suivantes :



Sauvegarder et rappeler des fichiers de configuration et de préférences

Gérer des fichiers, et notamment créer des captures d'écran

Configurer les interfaces LAN (en option sur le modèle 34460A), GPIB (en option sur tous les modèles) et USB

Exécuter des autotests et des fonctions d'administration de l'instrument

Configurer la date et l'heure de l'instrument, ainsi que divers paramètres utilisateur

Utility (Utilitaire) – Autocalibration (Étalonnage automatique) (34465A/70A uniquement)

L'étalonnage automatique compense la dérive due aux variations de temps et de température dans les mesures en tension continue et de résistance, et ajuste certains aspects d'autres fonctions de mesure.

Pour effectuer rapidement un étalonnage automatique sans modifier le message de chaîne d'étalonnage, appuyez sur la touche **Shift > ACAL (Up Arrow)**.

Pour modifier le message de chaîne d'étalonnage et effectuer un étalonnage automatique à l'aide des menus et des touches de fonction, procédez comme suit.

Étape 1 : Appuyez sur la touche **Utility** du panneau avant.

Étape 2 : Appuyez sur la touche de fonction **Test/Admin** :



Étape 3 : Appuyez sur la touche de fonction **Calibrate** :



Étape 4 : (Étape facultative) Appuyez sur la touche de fonction **Edit Cal String** et saisissez les informations relatives au message de chaîne d'étalonnage. Les messages courants incluent la dernière date d'étalonnage, la date d'échéance de l'étalonnage ou les coordonnées du service d'étalonnage. Une fois l'opération terminée, appuyez sur la touche de fonction **Done**.

Étape 5 : Appuyez sur la touche de fonction **Perform Autocal**.

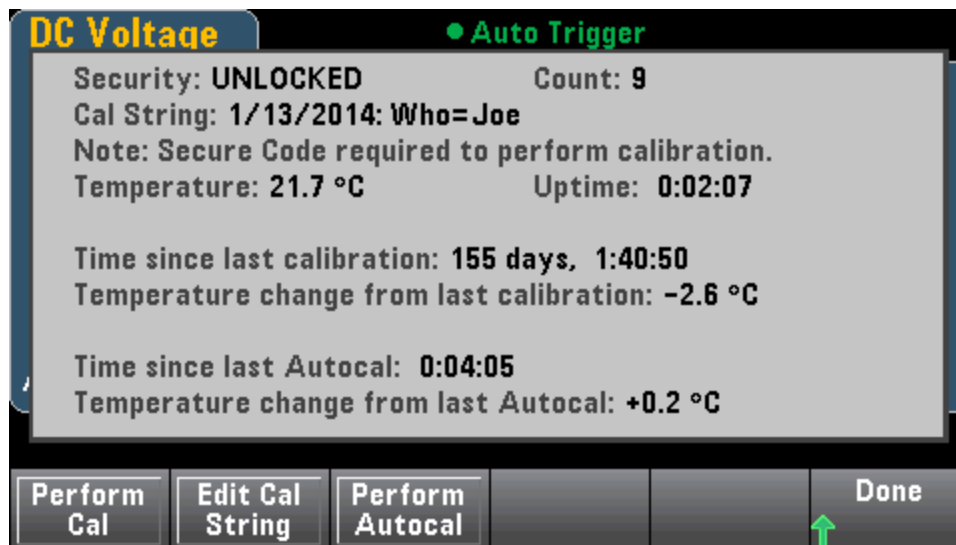

Utility (Utilitaire) – Sauvegarder et rappeler des fichiers de configuration et de préférences

Le menu Utility (Utilitaire) est présenté ci-dessous.



Appuyez sur **Store/Recall** pour sauvegarder et rappeler les fichiers de configuration et de préférences. En règle générale, les fichiers de configuration enregistrent les paramètres volatiles associés aux mesures. Les préférences sont des paramètres non volatiles associés à l'instrument, mais à aucune mesure spécifique. Pour de plus amples informations, reportez-vous au tableau de la section [Sous-système de configuration et de préférences MMEemory](#).



Store Settings (Sauvegarder les réglages)

La touche **Store Settings** vous permet d'accéder à un répertoire et de spécifier un nom de fichier, et d'indiquer si vous souhaitez sauvegarder un fichier de configuration ou un fichier de préférences.

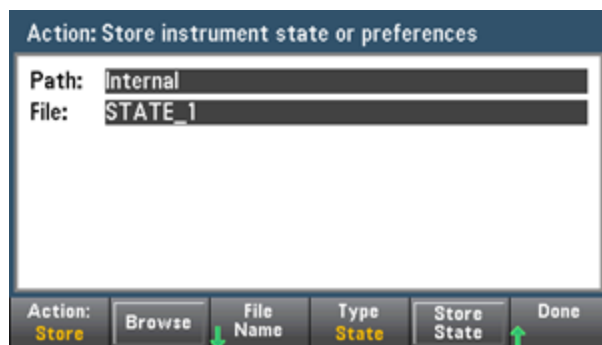

Appuyez sur **Type** pour déterminer si vous souhaitez sauvegarder un fichier de configuration ou de préférences, puis sur la touche **Store State** (illustrée ci-dessus) ou **Store Pref** (libellé de la touche de fonction en cas de sauvegarde des préférences) pour sauvegarder le fichier spécifié.

La touche **Action** vous permet de sauvegarder un fichier ou de créer un nouveau dossier.

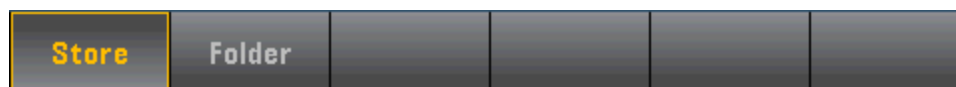

Recall Settings (Rappeler les réglages)

La touche **Recall Settings** vous permet d'accéder au fichier à rappeler. Utilisez les touches fléchées pour accéder au fichier de configuration (*.sta) ou au fichier de préférences (*.prf) désiré.



Power On (Mise sous tension)

La touche **Power On** permet de sélectionner la configuration qui est chargée à la mise sous tension. Il peut s'agir de la configuration de l'instrument au moment de sa mise hors tension à l'aide de l'interrupteur d'alimentation (**Last**), d'un fichier de configuration sélectionné par l'utilisateur (**User Defined**) ou de la configuration par défaut définie en usine (**Factory Defaults**).



Set to Defaults (Rétablir les réglages par défaut)

La touche **Set to Defaults** permet de charger les paramètres de configuration ou de préférences par défaut d'usine de l'instrument.

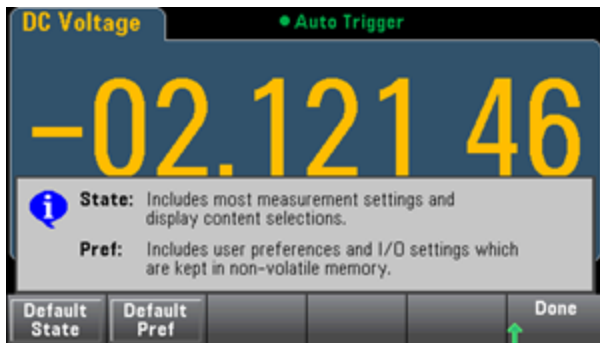

Menu Utility (Utilitaire) - Manage Files (Gérer les fichiers)



La touche de fonction **Manage Files** vous permet de créer, de copier, de supprimer et de renommer des fichiers et des dossiers dans la mémoire flash interne de l'instrument ou sur un lecteur USB connecté au panneau avant. Elle vous permet également de figer l'écran actuel dans un fichier bitmap (*.bmp) ou portable network graphics (*.png). Cette option est sélectionnée par défaut, comme indiqué ci-dessous.



Action

La touche **Action** indique l'action à effectuer. Le fait d'appuyer sur **Capture Display** entraîne l'enregistrement d'une capture d'écran au moment où vous avez appuyé sur la touche **[Shift]** pour accéder au menu **[Utility]**.



Delete - Pour supprimer un fichier ou un dossier, appuyez sur **Delete** et **accédez** au dossier ou au fichier à supprimer. Appuyez sur **Select > Perform Delete > Done**.

Folder - Pour créer un dossier, **accédez** à l'emplacement interne ou externe du dossier, appuyez sur **File Name**, saisissez un nom de dossier et appuyez sur **Done**. Appuyez sur **Create Folder > Done**.

Copy - Pour copier un fichier ou un dossier, appuyez sur **Copy**. **Accédez** au dossier ou au fichier à copier, puis appuyez sur **Select**. Appuyez sur **Copy Path** et sélectionnez un chemin d'accès interne ou externe pour la copie. Appuyez sur **Perform Copy > Done**.

Rename - Pour renommer un fichier ou un dossier, appuyez sur **Rename**. **Accédez** au dossier ou au fichier à renommer, puis appuyez sur **Select**. Appuyez sur **New Name**, saisissez un nouveau nom et appuyez sur **Done**. Appuyez sur **Perform Rename > Done**.

Browse (Parcourir)

La touche **Browse** permet de sélectionner le fichier ou le dossier sur lequel l'action sera effectuée.

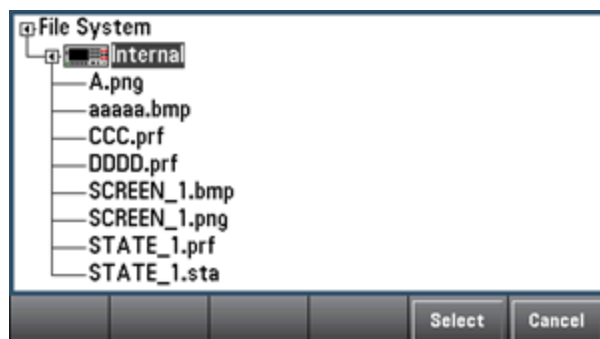

Utilisez les flèches du panneau avant et la touche **[Select]** pour parcourir la liste, et appuyez sur **Select** ou sur **Cancel** pour quitter la fenêtre de navigation. Les flèches vers la gauche et vers la droite permettent de réduire ou de développer un dossier pour masquer ou afficher les fichiers correspondants.

File Name (Nom de fichier)

La touche **File Name** vous permet d'utiliser les flèches du panneau avant, la touche **[Select]**, ainsi que les touches de fonction permettant de saisir un nom de fichier. Utilisez les flèches du panneau avant pour pointer vers une lettre, et les touches **Previous Char** et **Next Char** pour déplacer le curseur dans la zone où le nom est saisi. L'image ci-dessous n'illustre aucune touche de fonction **Next Char** car le curseur est en fin de ligne.

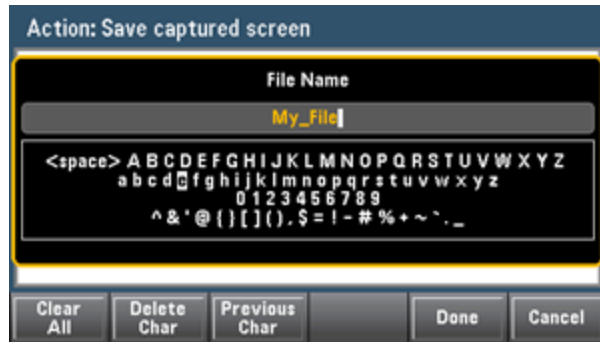

Appuyez sur **[Done]** ou sur **[Cancel]** pour terminer.

Menu Utility (Utilitaire) - I/O Configuration (Configuration des E/S)



La touche **I/O Config** permet de configurer les paramètres d'E/S pour les opérations à distance sur l'interface LAN (en option sur le modèle 34460A), USB ou GPIB (en option).



La touche **LAN** permet d'activer et de désactiver l'interface LAN de l'instrument, alors que la touche **LAN Reset** permet de réinitialiser le réseau local avec ses paramètres actuels, et d'activer DHCP et mDNS. La touche de fonction **LAN Reset** permet également d'effacer tout mot de passe d'interface Web défini par l'utilisateur.

LAN Settings (Paramètres LAN)

La touche **LAN Settings** permet d'accéder au menu illustré ci-dessous. La touche **Set to Defaults** permet de rétablir les valeurs par défaut des paramètres LAN.



Modify Settings (Modifier les paramètres)

La touche **Modify Settings** permet d'activer l'attribution DHCP ou manuelle (Auto-IP) de l'adresse IP de l'instrument. Elle permet également d'activer la configuration des paramètres réseau d'après le protocole (DHCP ou Manuelle) sélectionné.



Par exemple, appuyez sur **Host Name** ou **Service mDNS** pour modifier le nom d'hôte de l'instrument ou le nom du service mDNS, illustré ci-dessous.

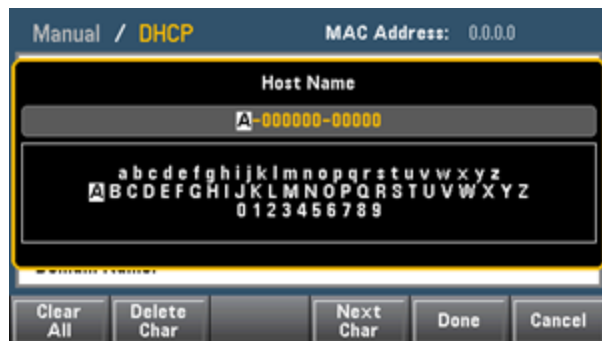

LAN Services (Services LAN)

La touche **LAN Services** permet d'activer ou de désactiver les services LAN illustrés ci-dessous.



Après avoir activé/désactivé un ou plusieurs services, appuyez sur **Done** > **Apply Changes**. Après cela, vous devez éteindre l'instrument et le remettre sous tension pour que les nouveaux réglages soient pris en compte.

Le serveur Web active ou désactive la programmation de l'instrument à partir de son interface Web.

Le service multicast DNS (mDNS) s'utilise dans les réseaux où aucun serveur DNS conventionnel n'est installé. La mise hors puis sous tension ou la réinitialisation du LAN active toujours le mDNS.

Le port Telnet de l'instrument est 5024. Ouvrez les sessions SCPI sur la connexion Telnet en saisissant ce qui suit :

```
telnet adresse IP 5024
```

Pour de plus amples informations sur les VXI-11, les sockets et les protocoles HiSLIP, consultez l'aide de Keysight IO Libraries.

USB Settings (Paramètres USB)

La touche **USB Settings** permet de configurer les connecteurs USB (stockage) du panneau avant et USB (connectivité) du panneau arrière.

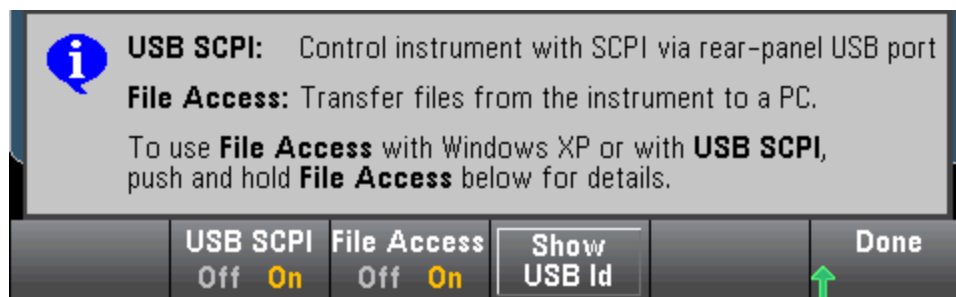

REMARQUE L'option SEC sous licence vous donne également la possibilité d'activer ou de désactiver l'interface USB du panneau avant via la touche de fonction **USB Front**. Cette option peut être commandée en usine ou sous forme d'option installée par le client. Pour de plus amples informations, reportez-vous à la section **Modèles et options**. Sans cette option, l'interface USB du panneau avant est toujours activée.

USB SCPI (SCPI USB)

La touche **USB SCPI** permet d'activer ou de désactiver le port de commande USB du panneau arrière. Après avoir modifié l'état de l'interface, vous devez éteindre, puis rallumer l'instrument pour que la modification soit prise en compte. Lorsque cette option est désactivée, l'interface ne peut pas être configurée par l'utilitaire Keysight IO Libraries Connection Expert.

Caractéristiques et fonctions

Easy File Access (touche de fonction File Access)

La touche de fonction **Easy File Access** utilise le protocole de transfert de fichiers multimédia (MTP) pour télécharger facilement les fichiers de l'instrument vers votre ordinateur. Connectez simplement le port USB du panneau arrière de l'instrument à un port USB de votre ordinateur. Le multimètre s'affiche comme lecteur en lecture seule sur le système de fichiers de votre ordinateur.

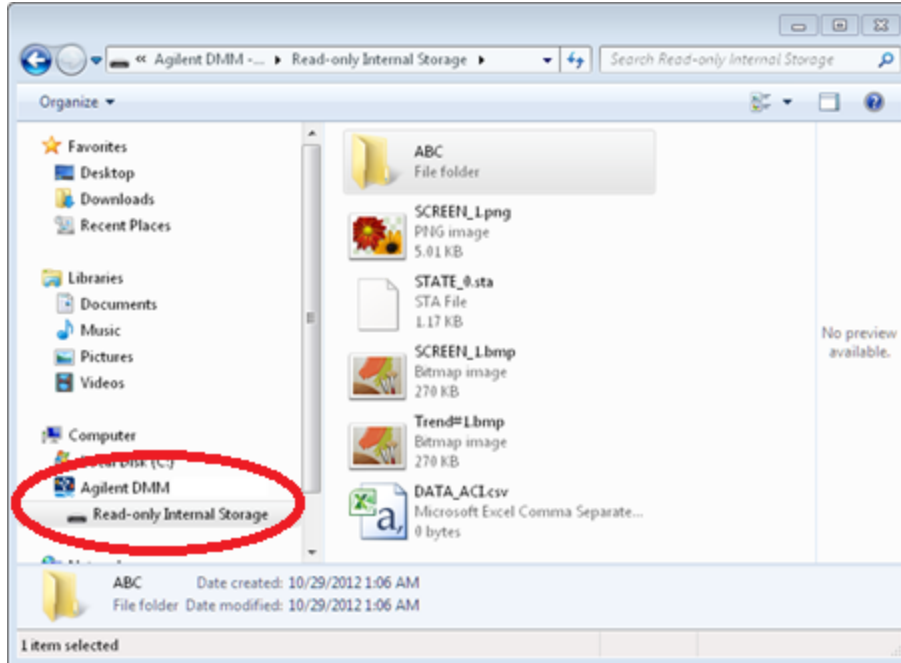

Vous pouvez utiliser les fonctionnalités standard de gestion de fichiers de votre ordinateur pour copier des fichiers du multimètre sur votre ordinateur.

REMARQUE Pour utiliser la touche **Easy File Access** en même temps que vous programmez l'instrument à distance avec SCPI sur l'interface USB (**USB SCPI**), vous devez installer Agilent IO Libraries Suite 16.3 ou version ultérieure sur votre ordinateur. Vous pouvez télécharger la dernière version à l'adresse www.keysight.com/find/iosuite.

Pour utiliser la touche **Easy File Access** sur un ordinateur exécutant le système d'exploitation Windows XP, assurez-vous que Microsoft Windows Media Player 11 pour Windows XP SP2, SP3 ou une nouvelle version de Windows sont installés. Vous pouvez télécharger ce logiciel à l'adresse www.microsoft.com/en-us/download/details.aspx?id=8163.

GPIB Settings (Paramètres GPIB) (en option)

La touche **GPIB Settings** permet d'activer ou de désactiver l'interface GPIB de votre instrument.

Lorsque cette option est désactivée, l'interface ne peut pas être configurée par l'utilitaire Keysight IO Libraries Connection Expert.

Vous pouvez également définir l'adresse GPIB à une valeur comprise entre 0 et 30. Après avoir activé ou désactivé l'adresse GPIB ou modifié l'adresse, vous devez éteindre puis rallumer l'instrument afin que la modification soit prise en compte.



Menu Utility (Utilitaire) - Test/Admin (Test/Administration)



La touche **Test/Admin** permet d'accéder aux fonctions d'autotest, d'étalonnage et d'administration :



Self-Test (Autotest)

La touche **Self-Test** vérifie le bon fonctionnement de l'instrument. Pour de plus amples informations, reportez-vous aux [procédures d'autotest](#) et déconnectez en toute sécurité les entrées des bornes du multimètre numérique avant d'effectuer le test complet.

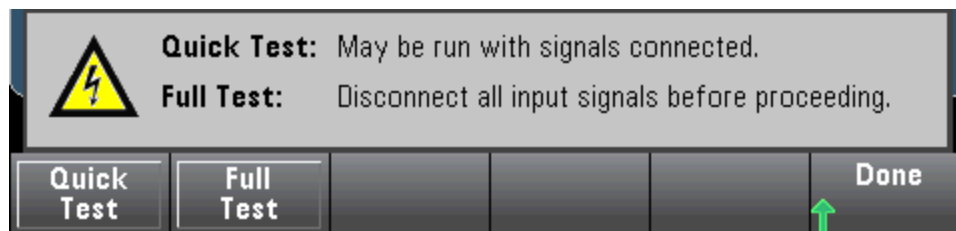

Calibrate (Étalonner)

La touche **Calibrate** permet d'accéder à la procédure d'étalonnage de l'instrument. Pour de plus amples informations, reportez-vous à la section [Étalonnage](#).

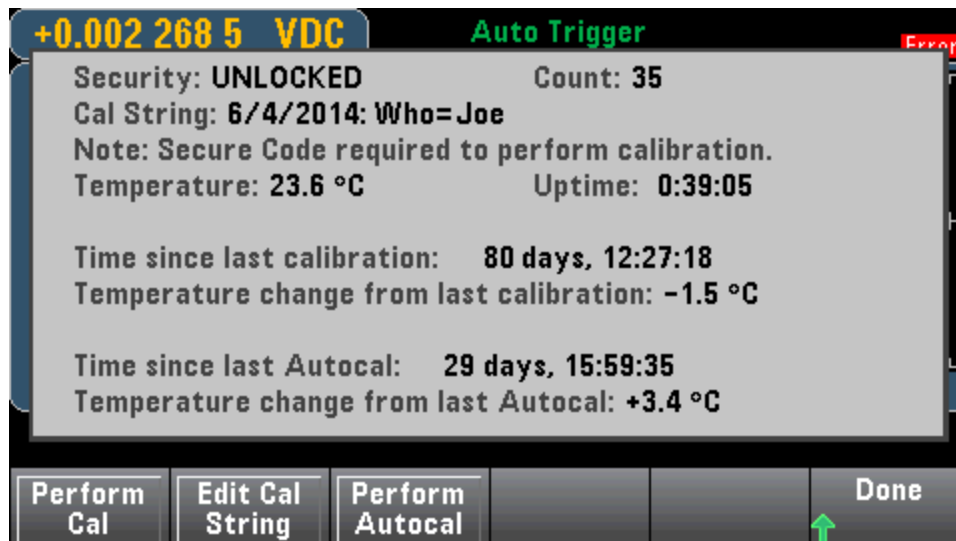

Security (Sécurité)

La touche **Security** permet de gérer le code de sécurité et les fonctions de sécurité. Si vous disposez de l'option SEC, vous devez saisir le code sécurisé pour configurer certaines fonctions.

La touche **NISPOM Sanitize** permet d'assainir toute la mémoire de l'instrument accessible à l'utilisateur, à l'exception des constantes d'étalonnage, et de redémarrer l'instrument. Cette commande est conforme aux exigences du Chapitre 8 du National Instrument Security Program Operating Manual (NISPOM).

MISE EN GARDE

La touche de fonction **NISPOM Sanitize** et la commande `SYSTEM:SECurity:IMMEDIATE` ont la même fonction. Elles sont destinées à des clients (ex. sous-traitants militaires) qui doivent satisfaire les exigences NISPOM.

Cette fonction détruit toutes les informations d'état définies par l'utilisateur, les données de mesure et des paramètres d'E/S définis par l'utilisateur, tels que l'adresse IP. Son utilisation est déconseillée dans les applications de routine en raison des risques de perte involontaire de données.

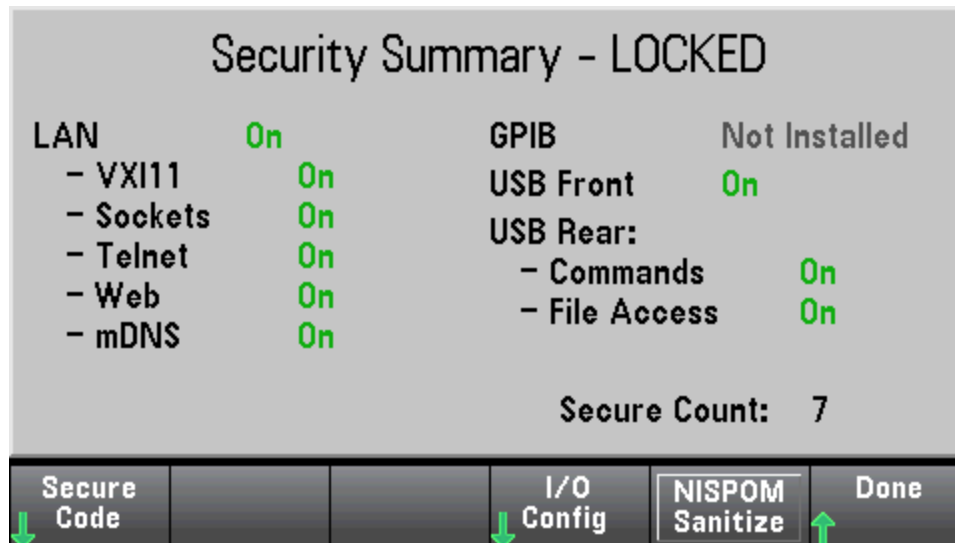

Install License (Installer la licence)

La touche **Install License** active les fonctions sous licence de l'instrument. Pour de plus amples informations sur l'obtention de licences, rendez-vous sur www.keysight.com/find/truevolt.

Après avoir reçu un fichier de licence de Keysight, effectuez la procédure suivante pour installer la licence :

1. Sauvegardez le fichier de licence sur une clé USB et branchez cette dernière au connecteur USB du panneau avant du multimètre.
2. Appuyez sur **[Shift]** > **[Utility]** > > **Test/Admin.Install License**
3. Utilisez les touches fléchées du panneau avant pour accéder au fichier de licence, puis appuyez sur **Select**.
4. Le message **License Installation Successful** (Installation de la licence réussie) s'affiche une fois l'installation réussie.

Mise à jour du microprogramme

La touche **Firmware Update** met à jour le microprogramme de l'instrument vers une nouvelle version. Pour de plus amples informations, reportez-vous à la section **Mise à jour du microprogramme**.

Menu Utility (Utilitaire) – System Setup (Configuration système)



La touche **System Setup** permet de configurer les préférences de l'utilisateur, de régler la date et l'heure et de définir un message à afficher lors de la mise sous tension.



User Settings (Réglages de l'utilisateur)

La touche **User Settings** permet de spécifier les préférences de l'utilisateur qui déterminent la manière dont l'utilisateur interagit avec l'instrument. Ces paramètres sont stockés dans la mémoire non volatile et peuvent être enregistrés dans un fichier de préférences (.prf).



Help Language (Langue de l'aide)

La touche **Help Lang** permet de sélectionner la langue de l'aide pour une utilisation du panneau avant : Anglais, Français, Allemand, Japonais, Coréen, Russe ou Chinois simplifié. L'ensemble des messages, l'aide contextuelle et les rubriques d'aide apparaissent dans la langue sélectionnée. Les libellés des touches de fonction sont toujours en anglais.

Number Format (Format numérique)

La touche **Number Format** permet de spécifier le mode d'affichage des nombres sur le panneau avant : 12,345.6 ou 12.345,6. D'autres possibilités existent. Par exemple, vous pouvez utiliser l'espace comme séparateur.



Sounds (Sons)



Désactive ou active le clic entendu lorsqu'une touche ou une touche de fonction du panneau avant est enfoncée.

Permet également d'activer ou de désactiver la tonalité audible (**Beeper On** ou **Off**) associée aux fonctionnalités suivantes :

- Limits (Limites) : une limite de mesure est dépassée (si les limites sont activées)
- Probe Hold (Maintien de la sonde) : le signal mesuré enregistre une lecture stable

Caractéristiques et fonctions

- Diode : la tension de polarisation directe est comprise entre 0,3 et 0,8 V
- Continuity (Continuité) : un court-circuit est mesuré (inférieur ou égal à 10 Ω)
- Error (Erreur) : une erreur est générée à partir du panneau avant ou de l'interface de commande à distance

Ce paramètre non volatile apparaît dans différents menus du panneau avant. L'activation ou la désactivation de l'avertisseur sonore dans un menu influence tous les autres menus et fonctions de la même manière. Par exemple, la désactivation de l'avertisseur sonore pour le maintien de la sonde entraîne également sa désactivation pour les limites, la diode, la continuité et les erreurs.

Options d'affichage

La touche **Display Options** permet de configurer l'écran.



Vous pouvez activer ou désactiver l'écran, régler la luminosité (entre 10 et 100 %), activer ou désactiver l'écran de veille, et sélectionner un modèle de couleurs. Si vous désactivez l'écran, appuyez sur l'une des touches du panneau avant pour le réactiver.

Par défaut, l'écran de veille se désactive et occulte l'écran après huit heures d'inactivité. Vous pouvez désactiver cet écran de veille uniquement sur le panneau avant.

L'écran est activé lorsque l'alimentation est appliquée après une réinitialisation de l'instrument (***RST**) ou lorsque vous retournez au mode local (panneau avant). Appuyez sur la touche **[Local]** ou exécutez la commande IEEE-488 GTL (Go To Local) à partir de l'interface distante pour revenir en mode local.

SCPI ID (ID SCPI)

La touche **SCPI ID** permet de déterminer la réponse de l'instrument à une requête ***IDN?**. Les options pour chaque modèle de multimètre numérique sont les suivantes :

- **34460A** : 34460A, AT34460A, HP34401A
- **34461A** : 34461A, AT34461A, HP34401A
- **34465A** : 34465A, AT34410A, AT34411A
- **34470A** : 34470A, AT34410A, AT34411A

Les options ci-dessus sans préfixe (modèle 34460A, par exemple) renvoient le nom de fabricant Keysight Technologies. Les options ci-dessus contenant le préfixe AT ou HP renvoient le nom de fabricant Agilent Technologies ou Hewlett Packard, respectivement. Ces options sont intégrées pour garantir la compatibilité ***IDN?** avec les programmes existants qui attendent d'***IDN?** le renvoi d'un fabricant et d'un numéro de modèle spécifiques.

Si vous possédez un ancien modèle Agilent 34460A ou 34461A et que vous effectuez une mise à niveau vers le nouveau microprogramme (Keysight), votre instrument continue de répondre avec le nom de fabricant « Agilent » et non « Keysight » tant que vous n'avez pas défini l'ID SCPI du panneau avant sur 34460A

ou 34461A, envoyé la commande **SYST:IDEN DEF** ou réinitialisé les préférences utilisateur. Une fois cette opération terminée, l'instrument répond avec le nom de fabricant « Keysight ».

Important : Pour mettre à jour le microprogramme de l'instrument à *partir de l'interface de commande à distance*, le numéro de modèle de la réponse ***IDN?** doit correspondre à celui de l'instrument réel. Si vous avez remplacé la réponse ***IDN?** de l'instrument par celle d'un autre instrument, lors de la tentative de mise à jour du microprogramme à partir de l'interface de commande à distance, l'erreur suivante s'affiche : *The instrument is not supported by this firmware file (L'instrument n'est pas pris en charge par ce fichier de microprogramme)*. Pour mettre le microprogramme à jour, suivez la procédure indiquée sur le panneau avant ou, dans l'interface de commande à distance, utilisez la commande **SYSTEM:IDENtify** pour définir la réponse ***IDN?** afin qu'elle corresponde au numéro de modèle réel, mettez le microprogramme à jour, puis réutilisez la commande **SYSTEM:IDENtify** pour définir la réponse ***IDN?** sur l'autre numéro de modèle.

Date / Time (Date / Heure)

La touche **Date / Time** permet de régler l'horloge en temps réel de l'instrument, qui utilise toujours le format 24 heures (00:00:00 à 23:59:59). Il n'existe aucun réglage automatique de la date et de l'heure, par exemple pour régler l'heure d'hiver et d'été. Utilisez les touches fléchées du panneau avant pour régler l'année, le mois, le jour, l'heure ou les minutes.

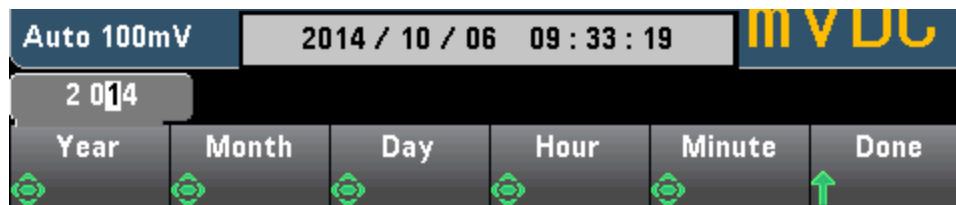

Power on Message (Message à la mise sous tension)

La touche **Power on Message** permet de définir un message qui s'affiche à la mise sous tension de l'instrument et lorsque vous appuyez sur **[Help] > About**.



Utilisez les touches fléchées du panneau avant et la touche **[Select]** pour sélectionner les lettres. Puis, appuyez sur **Done** pour quitter et enregistrer le message. Le message apparaîtra comme indiqué ci-dessous à la mise sous tension de l'instrument ou lorsque vous appuyez sur **[Help] > About**.



Interface Web

Les multimètres numériques Keysight série Truevolt intègrent une interface Web conçue pour surveiller et contrôler l'instrument à partir d'un navigateur Web. Pour commencer, connectez votre instrument au réseau local et saisissez l'adresse IP de l'instrument dans la barre d'adresse située en haut du navigateur Web de l'ordinateur, ou sélectionnez l'instrument dans Connection Expert et cliquez sur le bouton **Instrument Web Interface...** L'interface Web apparaît dans le navigateur comme indiqué ci-dessous (multimètre numérique 34465A).

REMARQUE Voici une présentation générale des quatre onglets Interface Web visibles sur le côté gauche



de la fenêtre Interface Web. Lors de l'utilisation de l'interface Web, cliquez sur le bouton d'aide pour obtenir des informations détaillées sur une page, par exemple :



Page d'accueil

La page d'accueil contient des informations de base sur l'instrument. Pour modifier l'une des informations affichées sur cette page, utilisez la [page Configuration](#).

Instrument Documentation and Technical Support | Keysight Home

KEYSIGHT TECHNOLOGIES 34465A 6-1/2 Digit Multimeter

Welcome to your

Web-Enabled 34465A
[Instrument Documentation and Technical Support](#)

Information about this Web-Enabled 34465A:

Instrument:	34465A
Serial Number:	PROTO00027
Description:	Keysight 34465A Digital Multimeter - PROTO00027
DNS Hostname:	DavesUnit
NetBIOS Name:	DavesUnit
mDNS Hostname:	DavesUnit.local
IP Address:	156.140.92.2
Instrument Address String:	TCPIP::DavesUnit::hislp0::INSTR TCPIP::DavesUnit::inst0::INSTR

LXI

Turn On Front Panel Identification Indicator

Advanced information about this Web-Enabled 34465A

Use the navigation bar on the left to access your 34465A and related information.

© Keysight Technologies 2014



Page de surveillance et de contrôle de l'instrument

Cette page vous permet de surveiller et de contrôler le multimètre numérique. Cette page s'ouvre en mode *Observe Only* (Observation seule) et ouvre automatiquement la fenêtre Surveiller le multimètre numérique (décrite ci-dessous). En mode *Observe Only*, les paramètres de commande de l'instrument sont grisés (désactivés). Ce mode vous permet d'effectuer un suivi des opérations du multimètre numérique à distance. La section **About** présente les licences installées, la révision du microprogramme et le numéro de série de l'instrument.

En mode *Allow Full Control* (Autoriser le contrôle intégral), cette fenêtre permet de configurer l'instrument et d'effectuer des mesures. Sélectionnez simplement les paramètres du multimètre numérique, puis cliquez sur **Apply**.

Caractéristiques et fonctions

Les six boutons situés en haut de l'écran sont décrits ci-dessous.

Surveillance du multimètre numérique

Lorsque la page principale est définie en mode *Observe Only*, cette fenêtre présente un affichage textuel des mesures du multimètre numérique et des mesures secondaires (si celles-ci sont activées), et des statistiques. En mode *Allow Full Control*, les boutons **Clear All** et, le cas échéant, **Clear Peaks** sont activés.

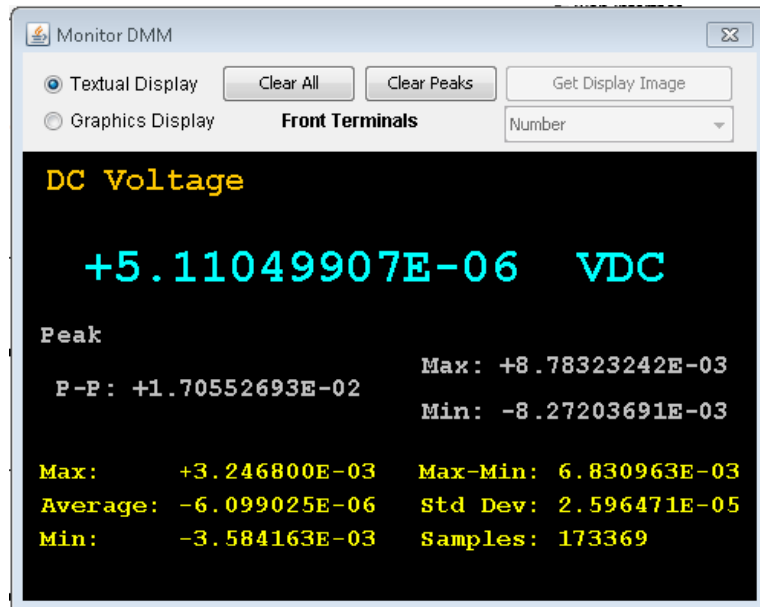

En mode *Allow Full Control*, pour visualiser les données telles que présentées sur l'affichage graphique de l'instrument (diagramme de tendance, histogramme, etc.), cliquez sur le bouton radio **Graphics Display** et cliquez sur **Get Display Image** pour mettre à jour l'affichage graphique :

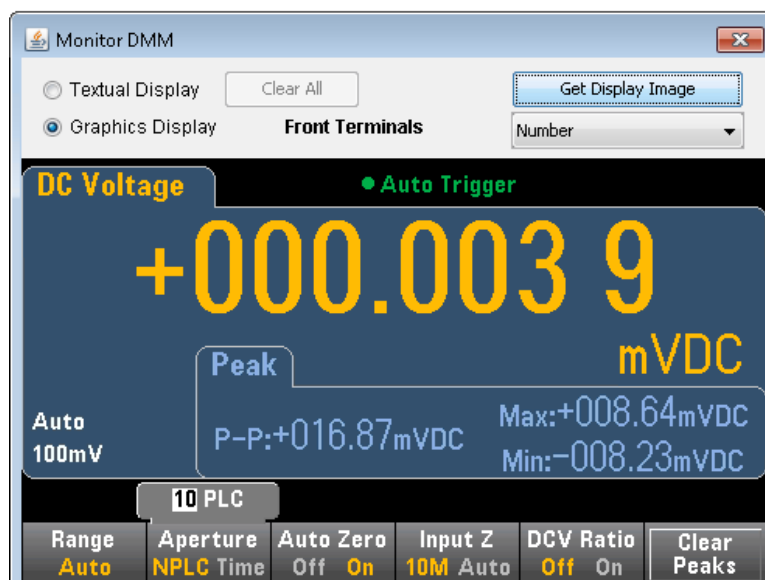

Visualisation des données

Pour les modes *Observe Only* et *Allow Full Control*, cette fenêtre maintient un affichage continu des mesures en mémoire (**Readings in Memory**) et active les commandes suivantes :

- **Readings** - Saisissez un index de départ (**Start Index**) (numéro de mesure) et un nombre de mesures à acquérir (**Number of Readings to Get**) pour afficher ces mesures au bas de la fenêtre et cliquez sur **Get Data**. Les mesures ne sont pas effacées de la mémoire de l'instrument. Activez/désactivez l'**index** ou les unités (**Units**) affichées à l'aide des cases à cocher. Mettez en surbrillance toutes les données affichées à l'aide de la souris et appuyez sur **Ctrl-C** pour copier le Presse-papiers Windows. Cliquez sur **Clear Data Window** pour effacer les mesures de l'affichage.
- **Last Value** - Cliquez sur **Last Value > Get Data** pour afficher la dernière mesure effectuée par le multimètre numérique.
- **Statistics Data** - Cliquez sur **Statistics Data > Get Data** pour afficher les valeurs maximale, moyenne, minimale, max-min, l'écart-type, l'écart standard et les échantillons (nombre de mesures).
- **Histogram Data** - Cliquez sur **Histogram Data > Get Data** pour afficher le nombre de mesures, la répartition automatique des cases (On ou Off), le nombre de cases, la plage supérieure, la plage inférieure et les données sur les cases.

En mode *Allow Full Control*, cette fenêtre possède les commandes supplémentaires :

- **Read and Remove Readings** - L'index de départ (**Start Index**) est fixé à 1. Saisissez le nombre de lectures à supprimer (**Readings to Remove**) et cliquez sur **Get Data** pour afficher ces mesures au bas de la fenêtre. Les mesures affichées SONT effacées de la mémoire de l'instrument.
- **Delete All Readings** - Supprime toutes les mesures de la mémoire de mesure de l'instrument et n'affiche aucune mesure.

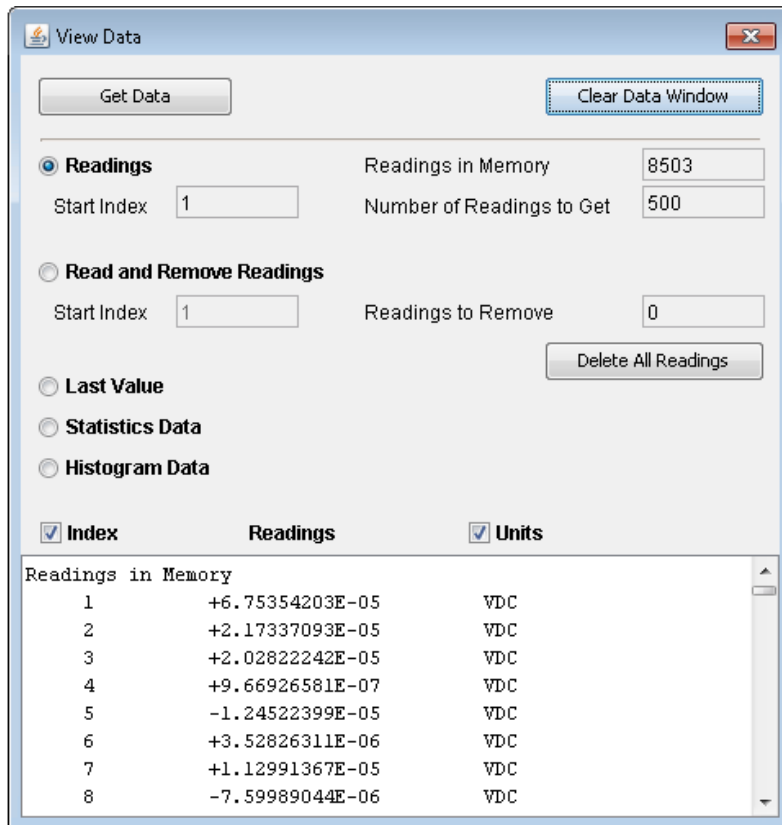

Présentation du multimètre numérique

Cette fenêtre génère des rapports contenant des informations sur le microprogramme, la configuration, l'étalonnage, la configuration SCPI et la file d'erreurs de l'instrument. Cochez les cases désirées situées sur le côté gauche de l'écran, puis cliquez sur **Generate Report**. La zone **Change in SCPI Configuration** génère une liste de toutes les commandes SCPI nécessaires pour modifier l'état de l'instrument depuis la dernière génération d'un rapport. Elle constitue un moyen pratique d'apprendre la syntaxe SCPI.

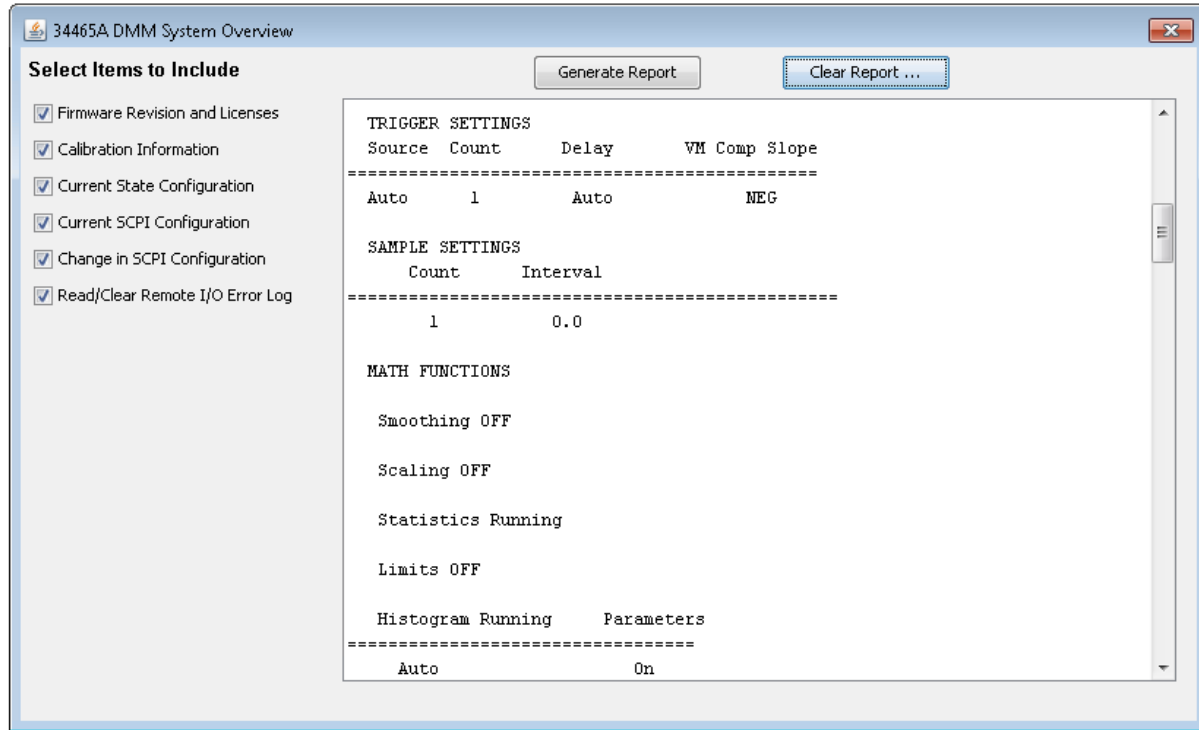

Sauvegarde/Rappel

En mode *Allow Full Control*, cette fenêtre sauvegarde, rappelle et supprime des configurations de l'instrument.

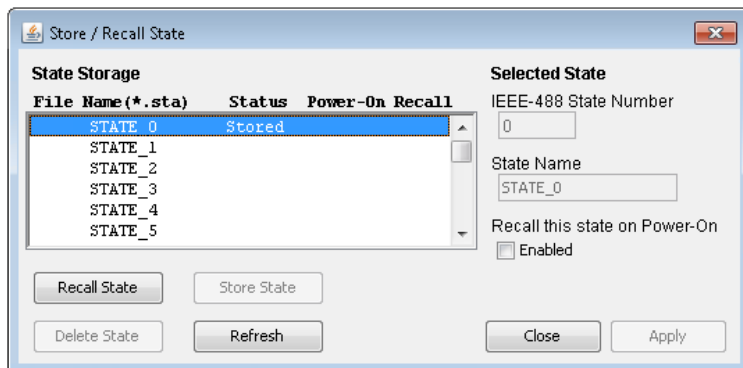

Commandes

En mode *Allow Full Control*, cette fenêtre vous permet d'envoyer des commandes au multimètre numérique de façon interactive et de lire les réponses. Vous pouvez utiliser ce dernier pour vous familiariser

avec le jeu de commandes de l'instrument et de concevoir rapidement des prototypes de commande et de vérifier les réponses avant l'écriture du code. Les boutons situés sur le côté droit de la fenêtre permettent d'envoyer une commande Device Clear, *RST ou d'envoyer et de lire les commandes *IDN? or SYST:ERR?.

Dans le champ **Enter SCPI command or query**, saisissez les commandes SCPI et cliquez sur **Send** pour exécuter la commande, sur **Read** pour relire une réponse ou sur **Send & Read** pour exécuter la commande et relire la réponse.

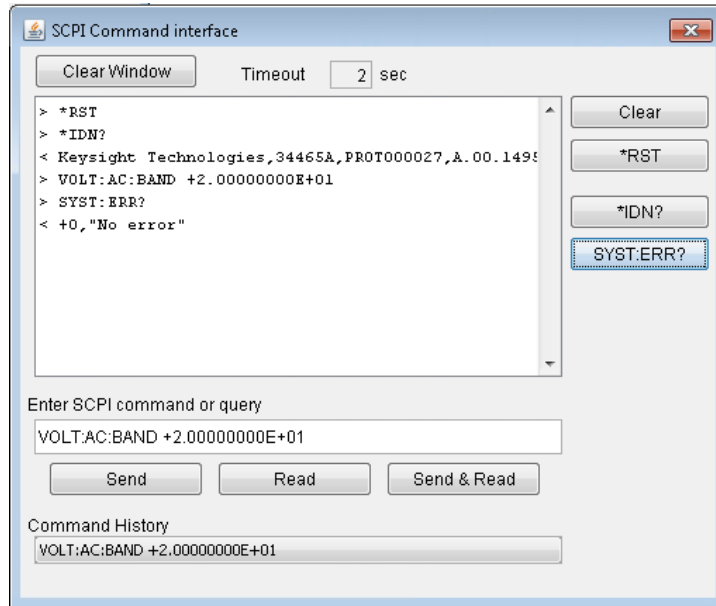

Exécution d'un étalonnage automatique

En mode *Allow Full Control*, cliquez sur le bouton **Run Autocal** pour effectuer un étalonnage automatique (autocal). Pendant l'étalonnage automatique, ce bouton est grisé jusqu'à ce que l'opération soit terminée (généralement de 15 à 20 secondes).

Page de configuration

La page de configuration vous permet de visualiser les paramètres de configuration réseau de l'instrument, qui permettent de configurer l'instrument afin qu'il fonctionne dans votre environnement. Pour modifier un paramètre, cliquez sur **Modify Configuration**.



Configuration of your 34465A

[Modify Configuration](#)

Parameter	Currently in use
IP Address Configuration:	Automatic
IP Address:	169.254.4.61
Subnet Mask:	255.255.0.0
Default Gateway:	169.254.4.61
DNS Server(s):	
Desired Hostname	A-34465A-00027
Domain:	
Description:	Agilent 34465A Digital Multimeter - PROTO00027

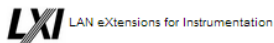

Aide

Une aide est disponible pour chacun des onglets décrits ci-dessus. Par exemple :



34465A 6 1/2 Digit Multimeter

Configuration Page Help

The Configuration page allows you to view the instrument's network configuration parameters, which configure the instrument to operate in your environment. To modify a parameter, click **Modify Configuration**.

You may set or clear a password from the Modify Configuration page. The default is no password (disabled). If a password has been set, you will be prompted for it before going to the Modify Configuration and Browser Web Control pages.

The parameters on the Current Configuration page are:

- **IP Address Configuration**
If this is set to Automatic, the IP Address, Subnet Mask, and Default Gateway were determined automatically, either from DHCP or if a DHCP server was not found, from Dynamically Configured Link Local Addressing (Auto-IP). If it is set to Manual, the IP Address, Subnet Mask, and Default Gateway were set to the manually configured values.
- **IP Address**
This is used for TCP/IP communications with the instrument. The IP Address Configuration indicates how the address was determined.
- **Subnet Mask**
This parameter enables the instrument to determine whether an IP Address is on the same local subnet. When an address is on a different subnet, all packets must be sent to a gateway. The IP Address Configuration (above) indicates how the subnet mask was determined.
- **Default Gateway**
This is the IP address of the default gateway that allows the instrument to communicate with devices that are not on the local subnet. Packets that are destined for a device not on the local subnet, as determined by the subnet mask, are sent to the default gateway. The IP Address Configuration (above) indicates how the default gateway was determined.
- **DNS Server(s)**
These are the IP addresses of the Domain Name System (DNS) servers. The server provides a hostname for a given IP Address based on entries in its

Didacticiel de mesure

Pour un niveau de précision optimal sur les multimètres Keysight série Truevolt, suivez les recommandations fournies dans les sections ci-dessous.

Métrologie

Considérations relatives aux mesures en courant continu

Réjection du bruit

Considérations relatives aux mesures de résistance

Mesures de valeurs efficaces vraies en courant alternatif

Capacité

Numérisation

Enregistrement de données

Autres fonctions de mesure principales

Déclenchement par niveau

Mesures haut débit

Autres sources d'erreur de mesure

Considérations relatives aux mesures

Pour atteindre un niveau de précision optimal sur les multimètres Keysight série *Truevolt*, vous devez éliminer les erreurs de mesure potentielles. Ce chapitre décrit les erreurs courantes et préconise des méthodes pour les éviter.

Métrologie

Le multimètre numérique 7½ chiffres 34470A convient idéalement aux applications de métrologie de haute précision. Keysight prévoit de nombreuses notes d'application destinées à maximiser la précision de mesure, par exemple :

Conseils pratiques pour l'optimisation de la précision de mesure avec votre multimètre numérique : cette page Web contient de nombreux liens vers des notes d'application couvrant les erreurs de mesure du multimètre numérique et décrivant la procédure à suivre pour effectuer des mesures de température.

Optimisation des mesures à l'aide de votre multimètre numérique : cette page Web contient de nombreux liens vers des notes d'application couvrant l'amélioration des mesures de valeur efficace vraie, les erreurs de câblage du système, les erreurs de mesure en courant continu, de fréquence et de période, ainsi que les erreurs de mesure en tension alternative.

Optimisation des mesures en courant alternatif à l'aide de votre multimètre numérique : porte sur la précision de mesures en courant alternatif.

Optimisation des mesures de valeur efficace vraie à l'aide de votre multimètre numérique : porte sur la précision de mesures de valeurs efficaces vraies.

Mesures de température pratiques : didacticiel détaillé expliquant comment effectuer des mesures de température précises.

Consultez le site www.keysight.com pour rechercher les notes d'application répondant à vos besoins de mesure et de précision.

Considérations relatives aux mesures en courant continu

Erreurs de FEM thermique

Les tensions d'origine thermoélectrique représentent les causes d'erreur les plus fréquentes lors des mesures en tension continue de faible niveau. Ces tensions sont générées lorsque l'on relie des circuits à l'aide de fils en métaux différents, à des températures différentes. Chaque jonction entre deux métaux différents constitue un thermocouple qui génère une tension proportionnelle à la température de la jonction, comme indiqué dans le tableau ci-dessous. Vous devez minimiser les tensions de thermocouple et les variations de température. Les meilleures connexions utilisent des connexions serties de type cuivre sur cuivre, car les bornes d'entrée du multimètre numérique sont constituées d'un alliage en cuivre.

Cuivre sur :	Env.. $\mu\text{V} / ^\circ\text{C}$
Soudure étain-cadmium	0,2
Cuivre	<0,3
Or	0,5
Argent	0,5
Laiton	3
Cuivre au béryllium	5
Aluminium	5
Soudure plomb-étain	5
Kovar ou alliage 42	40
Silicium	500
Oxyde de cuivre	1000

Erreurs dues à la charge (tension continue)

Des erreurs de mesure dues à la charge se produisent lorsque la résistance de sortie du dispositif testé (DUT) représente un pourcentage appréciable de la résistance d'entrée du multimètre.

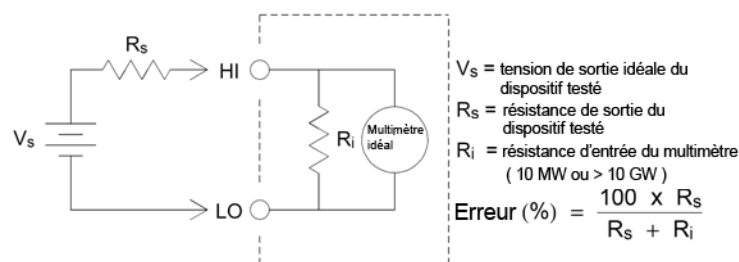

Pour limiter les effets des erreurs dues à la charge et minimiser le captage de bruit, réglez la résistance d'entrée du multimètre sur 10 G Ω (impédance élevée) pour les plages 100 mVcc, 1 Vcc et 10 Vcc. La résistance d'entrée est maintenue à 10 M Ω pour les plages 100 Vcc et 1 000 Vcc.

Réjection du bruit

Réjection des tensions de bruit engendrées par l'alimentation secteur

Il est souhaitable que les convertisseurs analogiques-numériques (A/N) à intégration soient capables de rejeter le bruit lié à la tension d'alimentation secteur qui existe avec les signaux en tension continue à l'entrée. C'est ce que l'on appelle la réjection de bruit de mode normal (RMN). Pour obtenir une réjection de bruit de mode normal, le multimètre mesure la moyenne du signal d'entrée en courant continu en « l'intégrant » sur une période fixe. Si vous définissez le temps d'intégration sur un nombre entier de cycles de la tension d'alimentation (PLC), ces erreurs (et leurs harmoniques) tendent vers zéro par pondération.

Le multimètre inclut trois options d'intégration (1, 10 et 100 PLC) permettant d'obtenir une réjection de bruit de mode normal. Le multimètre mesure la fréquence d'alimentation secteur (50 Hz ou 60 Hz), puis détermine le temps d'intégration correspondant. Pour une liste détaillant la réjection de bruit de mode normal, le bruit efficace ajouté moyen, la vitesse de lecture et la résolution pour chaque paramètre d'intégration, reportez-vous au tableau Performances et temps d'intégration.

Réjection de mode commun

Idéalement, un multimètre est entièrement isolé des circuits reliés à la masse. Toutefois, il existe une résistance finie entre la borne LO d'entrée et la masse, comme illustré ci-dessous. Cela peut provoquer des erreurs lors de la mesure de tensions faibles qui flottent par rapport à la masse.

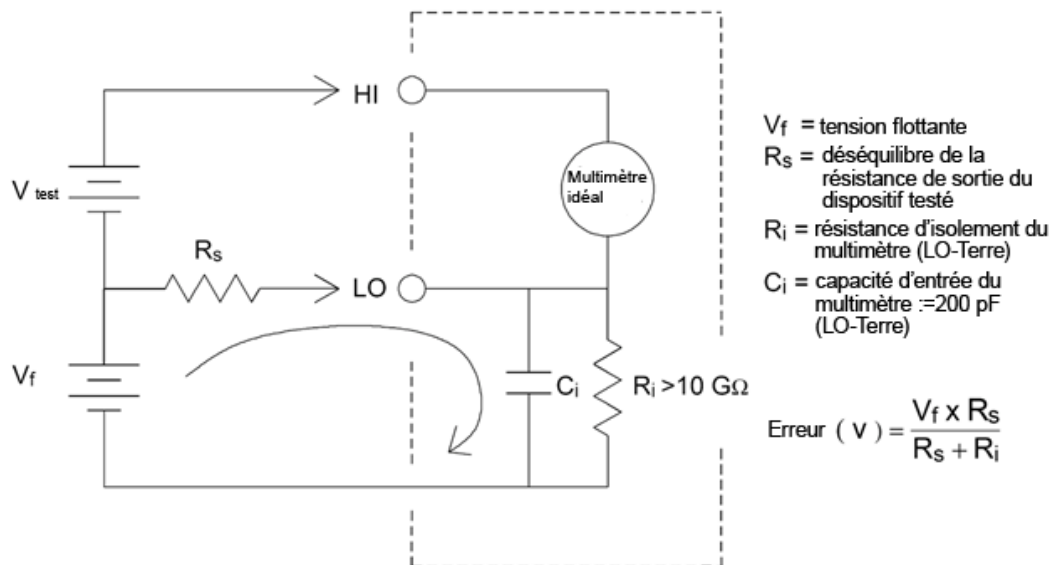

Bruit provoqué par les boucles magnétiques

Lors de la réalisation de mesures à proximité de champs magnétiques, évitez d'induire des tensions dans les connexions de mesure. Vous devez faire particulièrement attention lorsque vous travaillez à proximité de conducteurs qui transportent des courants élevés. Pour la connexion au multimètre, utilisez des connexions à paire torsadée afin de réduire la surface de la boucle de captage du bruit ou disposez les cordons de test aussi près que possible l'un de l'autre. Des cordons de test incorrectement fixés ou tendus induisent également des erreurs de tension. Fixez solidement les cordons de test à l'aide de serre-câbles lorsque vous travaillez à proximité de champs magnétiques. Chaque fois que possible, utilisez des matériaux de blindage magnétique ou éloignez-vous davantage des sources magnétiques.

Bruit provoqué par les boucles de masse

Lors de la mesure de tensions dans des circuits où le multimètre et le dispositif testé sont reliés à une masse commune, il se forme une « boucle de masse ». Comme l'illustre la figure ci-dessous, toute différence de tension entre les deux points de référence à la masse (V_{ground}) engendre un courant dans les cordons de mesure. Cela provoque une tension de bruit et de décalage (généralement liée à la tension d'alimentation secteur), qui vient s'ajouter à la tension mesurée.

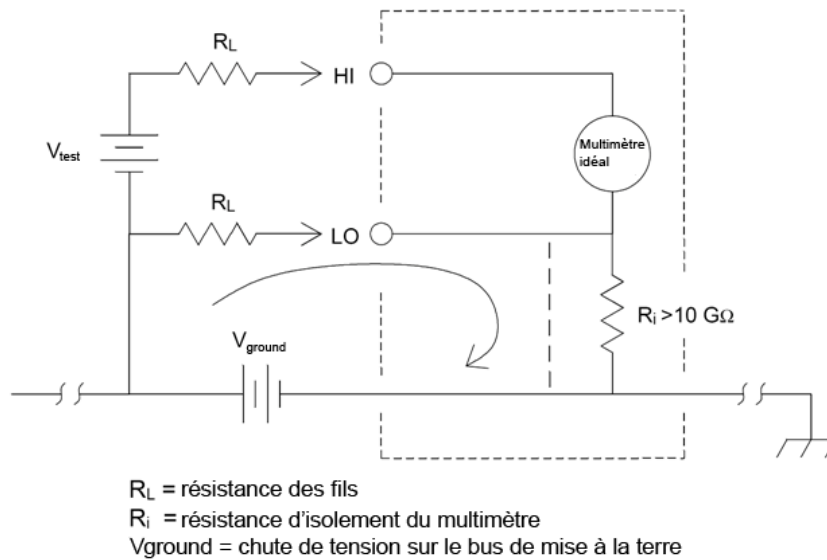

Le meilleur moyen d'éliminer les boucles de masse consiste à isoler le multimètre de la terre en évitant de mettre les bornes d'entrée à la masse. Si le multimètre doit être relié à la terre, connectez-le avec le dispositif testé à un point de masse commun. Connectez également le multimètre et le dispositif testé à la même prise électrique chaque fois que possible.

Considérations relatives aux mesures de résistance

Le multimètre permet de réaliser deux types de mesures de résistance : en 2 et 4 fils. Pour les deux méthodes, le courant de test passe de la borne d'entrée de niveau haut (HI) à la résistance mesurée. Lors d'une mesure en 2 fils, la chute de tension aux bornes de la résistance est mesurée dans le multimètre interne. La résistance des cordons de test est donc comprise dans la mesure. Pour la mesure en 4 fils, des connexions de mesure spécifiques sont requises. Aucun courant ne circulant dans ces connexions, leur résistance n'engendre pas d'erreur.

REMARQUE Les erreurs précédemment mentionnées dans ce chapitre pour les mesures de tension continue s'appliquent également aux mesures de résistance. Les sources d'erreur supplémentaires uniques aux mesures de résistance sont abordées ci-dessous.

La méthode de mesure en 4 fils est la méthode la plus précise pour les résistances de faible valeur car elle réduit les résistances des cordons de test et de contact. Cette méthode est souvent utilisée dans les applications de test automatisées comportant plusieurs connexions résistives et/ou à long câble ou des commutateurs entre le multimètre et le dispositif testé. Les connexions recommandations pour les mesures de résistance en 4 fils sont illustrées ci-dessous.

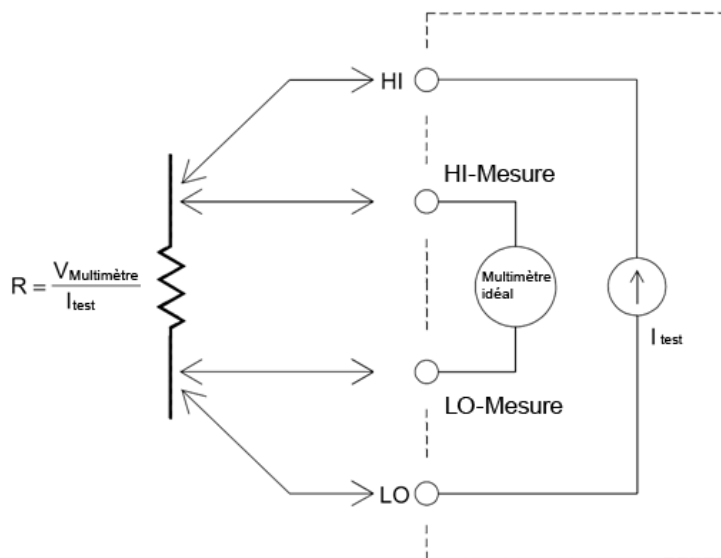

Pour les modèles 34465A et 34470A, vous pouvez également activer les mesures de résistance à compensation de décalage à l'aide de la commande `[SENSe:]{RESistance|FRESistance}:OCOMPensated {OFF|ON}`. La compensation de décalage supprime les effets de toutes les tensions continues dans le circuit mesuré. La méthode consiste à recueillir la différence entre deux mesures de résistance, une avec la source de courant réglée sur la valeur normale et l'autre avec la source de courant réglée sur une valeur inférieure.

Suppression des erreurs de résistance des cordons de test

Pour éliminer les erreurs de décalage associées aux mesures de résistance en 2 fils des cordons de test, procédez comme suit :

Court-circuitez simplement les cordons de test ensemble et relevez la résistance des cordons affichée.

Appuyez sur **Null**. Le multimètre stocke la résistance des cordons de test à la valeur de référence de résistance en 2 fils, et soustrayez cette valeur des mesures suivantes.

Voir également la section « Mesures par rapport à une référence ».

Minimisation des effets de la dissipation de puissance

Lors de la mesure de résistances conçues pour les mesures de température (ou d'autres dispositifs résistifs dotés de coefficients de température élevés), rappelez-vous que le multimètre dissipe une certaine puissance dans le dispositif testé. Le tableau suivant illustre plusieurs exemples.

Plage	Courant de test standard	Dissipation de puissance dans le dispositif testé
1 G Ω	500 nA	2,5 μ W
100 M Ω	500 nA	2,5 μ W
10 M Ω	500 nA	2,5 μ W
1 M Ω	5 μ A	25 μ W
100 k Ω	10 μ A	10 μ W
10 k Ω	100 μ A	100 μ W
1 k Ω	1 mA	1 mW
100 Ω	1 mA	100 μ W

Si la dissipation de puissance pose problème, sélectionnez une plage fixe plus élevée (tous les modèles de multimètres) ou, pour les modèles 34465A/70A, sélectionnez le mode de mesure de résistance de basse puissance (voir **Résistance** (panneau avant) ou **[SENSe:]{RESistance|FRESistance}:POWER:LIMit[:STATE]** (interface de commande à distance)). Le mode basse puissance génère moins de courant de test par plage de mesure que la normale pour les mesures de résistance standard afin de réduire la dissipation de puissance et l'auto-échauffement du dispositif testé. Le tableau suivant répertorie les diverses plages de résistance, le courant de test standard fourni pour les mesures de résistance en 2 e 4 fils et le courant de test en mode basse puissance.

Plage	Courant de test standard	Courant de test en mode basse puissance
1 G Ω	500 nA	500 nA
100 M Ω	500 nA	500 nA
10 M Ω	500 nA	500 nA
1 M Ω	5 μ A	5 μ A
100 k Ω	10 μ A	5 μ A
10 k Ω	100 μ A	10 μ A
1 k Ω	1 mA	100 μ A
100 Ω	1 mA	100 μ A

Erreurs de mesure de résistance élevée

Lors de la mesure de résistances élevées, la résistance d'isolement et le fait que les surfaces ne soient pas parfaitement propres peuvent engendrer des erreurs importantes. Veillez à la propreté du système de mesure des résistances élevées. Les cordons et les supports de test peuvent présenter des résistances de fuite résultant de l'absorption d'humidité par les isolants et du dépôt de salissures sur les surfaces. Le nylon et le PVC sont d'assez piètres isolants ($10^9 \Omega$), comparés aux isolants PTFE Teflon ($10^{13} \Omega$). La résistance de fuite des isolants en nylon ou en PVC peut engendrer une erreur de 0,1 % lors de la mesure d'une résistance de 1 M Ω dans un environnement humide.

Mesures de valeurs efficaces vraies en courant alternatif

Les multimètres répondant à la valeur efficace vraie, tels que le Keysight série *Truevolt*, mesurent le potentiel « thermique » d'une tension appliquée. La puissance dissipée dans une résistance est proportionnelle au carré d'une tension appliquée, indépendamment de la forme du signal. Ce multimètre mesure avec précision la tension ou le courant efficace vrai, dès lors que la forme du signal contient une faible quantité d'énergie supérieure à la bande passante efficace du multimètre.

Notez que le Keysight série *Truevolt* utilise les mêmes techniques pour mesurer la tension et le courant efficaces vrais. La bande passante de tension alternative efficace est de 300 kHz, alors que la bande passante de courant alternatif est de 10 kHz.

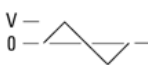
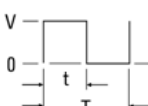
Forme du signal	Facteur de crête (C.F.)	Val. eff. (CA)	CA + CC efficace	Erreur de réponse à la valeur moyenne
	1.414	$\frac{V}{1.414}$	$\frac{V}{1.414}$	Étalonné pour 0 erreur
	1.732	$\frac{V}{1.732}$	$\frac{V}{1.732}$	-3.9%
	$\sqrt{\frac{T}{t}}$	$\frac{V}{C.F.} \times \sqrt{1 - \left(\frac{1}{C.F.}\right)^2}$	$\frac{V}{C.F.}$	-46 % pour un C.F. = 4

Les fonctions de voltmètre et d'ampèremètre en courant alternatif du multimètre mesurent la valeur efficace vraie en couplage de courant alternatif. Sur ce multimètre, seul le « potentiel thermique » des composantes alternatives du signal d'entrée est mesuré (la composante continue est rejetée). Comme l'illustre la figure ci-dessus, pour les signaux sinusoïdaux, triangulaires et carrés, les valeurs CA et CA+CC sont égales, car ces signaux ne présentent pas de tension de décalage en courant continu. Cependant, les signaux non symétriques (tels que les trains d'impulsions) comportent des composantes continues rejetées par les mesures de valeur efficace vraie couplée en courant alternatif. Cette approche comporte certains avantages.

Il est souhaitable de pouvoir effectuer une mesure de valeur efficace vraie en couplage CA lorsque l'on mesure des signaux alternatifs de faible amplitude en présence de fortes tensions continues de décalage. C'est une situation fréquente lors de la mesure en tension alternative d'ondulation d'une alimentation en courant continu. Dans certains cas, cependant, vous souhaitez connaître la valeur efficace vraie des composantes continue et alternative (CA + CC). Vous pouvez calculer cette valeur en associant les résultats des mesures de courants alternatif et continu, grâce à l'équation suivante :

$$ac + dc = \sqrt{ac^2 + dc^2}$$

Pour une réjection du bruit de la composante alternative, vous devez effectuer la mesure en courant continu avec un temps d'intégration d'au moins 10 cycles de tension d'alimentation (PLC).

Précision de la valeur efficace vraie et contenu en signaux à haute fréquence

Une erreur répandue consiste à penser que parce que le multimètre en courant alternatif mesure la valeur efficace vraie, sa précision en signaux sinusoïdaux s'applique à toutes les formes de signaux. En effet, la forme du signal d'entrée affecte considérablement la précision de mesure de tout multimètre, notamment lorsque ce signal inclut des composantes haute fréquence dépassant la bande passante de l'instrument.

Par exemple, supposons un train d'impulsions, l'un des signaux les plus complexes d'un multimètre. La largeur d'impulsion de ce signal détermine en grande partie son contenu haute fréquence. Le spectre de fréquence d'une impulsion unique est déterminé par son intégrale de Fourier. Le spectre de fréquence du train d'impulsions est la série de Fourier qui échantillonne sur l'intégrale de Fourier à des multiples de la fréquence de répétition de l'impulsion d'entrée (prf).

La figure ci-dessous illustre l'intégrale de Fourier de deux impulsions très différentes : l'une large (200 μ s) et l'autre étroite (6,7 μ s). La bande passante de la voie en tension alternative du multimètre est de 300 kHz. Par conséquent, le contenu fréquentiel supérieur à 300 kHz n'est pas mesuré.

Notez que le spectre $\sin(\pi fT)/\pi fT$ de l'impulsion étroite dépasse largement la bande passante efficace de l'instrument. Le résultat est une mesure moins précise de l'impulsion à haute fréquence étroite.

En revanche, le spectre de fréquence de l'impulsion large est tombé significativement au-dessous de la bande passante (approximative) de 300 kHz du multimètre. Les mesures de cette impulsion sont donc plus précises.

La réduction du PRF augmente la densité des lignes du spectre de Fourier, ainsi que la partie de l'énergie spectrale du signal d'entrée dans la bande passante du multimètre, améliorant ainsi la précision.

En résumé, les erreurs de mesure de valeur efficace vraie se produisent lorsqu'une quantité d'énergie non négligeable est présente dans le signal d'entrée à des fréquences supérieures à la bande passante du multimètre.

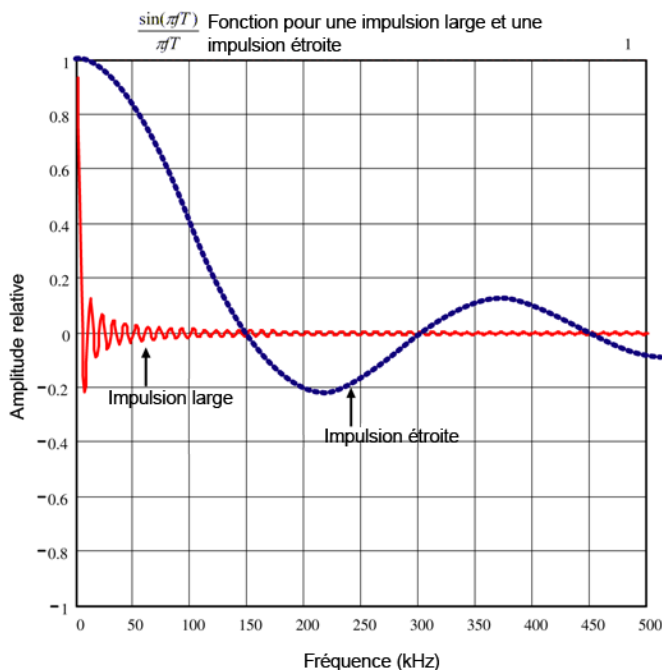

Estimation de l'erreur en haute fréquence (hors bande)

Un moyen courant de caractériser les formes de signaux est le « facteur de crête ». Le facteur de crête est le quotient de la valeur crête par la valeur efficace du signal. Pour un train d'impulsions, le facteur de crête est égal approximativement à la racine carrée de l'inverse du rapport cyclique.

$$CF = \frac{1}{\sqrt{d}} = \frac{1}{\sqrt{\frac{t_p}{T}}} = \frac{1}{\sqrt{prf \times t_p}}$$

Notez que le facteur de crête est un paramètre composé, selon la largeur d'impulsion et la fréquence de répétition. Le facteur de crête à lui seul n'est pas suffisant pour caractériser le contenu fréquentiel d'un signal.

Généralement, les multimètres numériques incluent un tableau de déclassement du facteur de crête qui s'applique à toutes les fréquences. Cet algorithme de mesure utilisé dans les multimètres numériques série *Truevolt* ne sont pas intrinsèquement sensibles au facteur de crête. Un tel déclassement n'est donc pas nécessaire. Pour ce multimètre, comme décrit dans la section précédente, le principal problème est le contenu en signaux à haute fréquence qui dépasse la bande passante.

Pour les signaux périodiques, la combinaison du facteur de crête et du taux de répétition peut fournir une indication de la quantité de contenu haute fréquence et d'erreurs de mesure associées. Le premier passage par zéro d'une simple impulsion se produit à $f_1 = 1/t_p$.

Cela donne une impression immédiate du contenu haute fréquence en identifiant l'emplacement où se produit ce passage comme fonction du facteur de crête : $f_1 = (CF^2)(prf)$.

Le tableau suivant illustre l'erreur type de divers signaux d'impulsions comme fonction de la fréquence d'impulsion d'entrée :

Erreur type pour des signaux carrés, des signaux triangulaires et des trains d'impulsions de CF=3, 5 ou 10					
PRF	signal carré	signal triangulaire	CF=3	CF=5	CF=10
200	-0,02 %	0,00 %	-0,04 %	-0,09 %	-0,34 %
1 000	-0,07 %	0,00 %	-0,18 %	-0,44 %	-1,71 %
2 000	-0,14 %	0,00 %	-0,34 %	-0,88 %	-3,52 %
5 000	-0,34 %	0,00 %	-0,84 %	-2,29 %	-8,34 %
10 000	-0,68 %	0,00 %	-1,75 %	-4,94 %	-26,00 %
20 000	-1,28 %	0,00 %	-3,07 %	-8,20 %	-45,70 %
50 000	-3,41 %	-0,04 %	-6,75 %	-32,0 %	-65,30 %
100 000	-5,10 %	-0,12 %	-21,8 %	-50,6 %	-75,40 %

Ce tableau fournit une erreur supplémentaire pour chaque signal, que l'on ajoute à la valeur du tableau de précision figurant dans la fiche technique de l'instrument

Les spécifications sont valides pour $CF \leq 10$, dès lors qu'une quantité d'énergie négligeable supérieure à la bande passante de tension de 300 kHz ou à la bande passante de courant de 10 kHz est observée dans le signal. Les performances du multimètre ne sont pas spécifiées pour $CF > 10$ ou lorsqu'il existe un contenu de signal hors bande significatif.

Exemple

Un train d'impulsions d'un niveau de 1 V eff. est mesuré sur la plage 1 V. Il présente des hauteurs d'impulsion de 3 V (c'est-à-dire, un facteur de crête 3) et une durée de 111 μ s. Le PRF peut être établi à 1 000 Hz, comme suit :

$$prf = \frac{1}{CF^2 \times t_p}$$

Ainsi, dans le tableau ci-dessus, ce signal de courant alternatif peut être mesuré avec une erreur supplémentaire de 0,18 pour cent.

Autres fonctions de mesure principales

Erreurs de mesure de fréquence et de période

Pour mesurer la fréquence et la période, le multimètre utilise une méthode de comptage réciproque. Cette méthode garantit la constance de la résolution de la mesure à toutes les fréquences d'entrée. La partie du multimètre qui mesure la tension alternative assure le conditionnement du signal d'entrée. Tous les fréquencemètres sont sensibles aux erreurs lors de la mesure de signaux à faible tension et à basse fréquence. Les effets de captage du bruit interne et du bruit externe sont critiques lors de la mesure de signaux « lents ». L'erreur est inversement proportionnelle à la fréquence. Des erreurs de mesure se produisent également lorsque l'on tente de mesurer la fréquence (ou la période) d'un signal d'entrée après une variation de la tension continue de décalage. Avant de réaliser une mesure de fréquence, laissez le condensateur de blocage de la tension continue à l'entrée du multimètre se stabiliser.

Courant continu

Lorsque vous connectez le multimètre en série à un circuit testé en vue de mesurer le courant, une erreur de mesure est introduite. Elle résulte de la chute de tension en série du multimètre. Une tension se développe aux bornes de la résistance de câblage et de la résistance de shunt de courant du multimètre, comme l'illustre la figure ci-dessous.

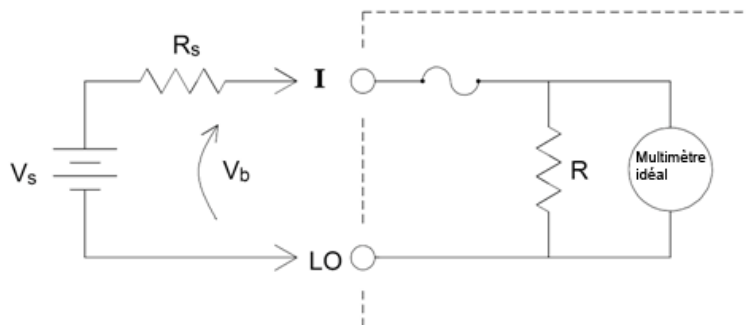

- V_s = tension source
- R_s = Résistance de sortie du dispositif testé
- V_b = chute de tension du multimètre
- R = shunt de courant du multimètre

$$\text{Erreur (\%)} = \frac{-100\% \times V_b}{V_s}$$

Évitez d'appliquer des signaux aux bornes d'entrée de courant inutilisées

Si des signaux d'entrée sont appliqués à des bornes non nécessaires pour la mesure de courant, des erreurs de mesure peuvent se produire. Les bornes inutilisées sont toujours protégées, mais les signaux inutiles peuvent interférer avec la mesure de courant. Par exemple, l'application d'entrées aux bornes 3 A pendant la réalisation de mesures sur les bornes 10 A provoque généralement des erreurs.

Les bornes de mesure Hi et Lo ne sont pas utilisées pour de nombreuses mesures. L'application de signaux ici lorsque cela n'est pas nécessaire peut également engendrer des erreurs. Les tensions

alternatives ou continues supérieures à 15 volts crête sur les bornes de mesure inutiles sont susceptibles de provoquer des erreurs de mesure. Si des erreurs inattendues se produisent, les signaux sur les bornes inutiles doivent être vérifiés.

REMARQUE

Les multimètres numériques 34465A/34470A avec le numéro de série MY59018001 et supérieur auront la conception matérielle qui permet des connexions simultanées.

Mesures de température

Pour les mesures de température, un capteur de température est nécessaire. Les sondes prises en charge sont des RTD en 2 fils et 4 fils, des thermistances en 2 fils et 4 fils (type 44004 de 2,2 k Ω , 44007 de 5 k Ω et 44006 de 10 k Ω voir les Exigences relatives aux thermistances ci-dessous) et, pour le 34465A/70A uniquement, des thermocouples de type E, J, K, N, R ou T.

Choix du type de sonde

Le RTD établit des rapports précis et extrêmement linéaires entre la résistance et la température, sur une plage approximative de -200 - 500 °C. La conversion d'un RTD ne présente quasiment aucune difficulté en raison de sa linéarité intrinsèque. Le multimètre permet la mesure du RTD standard IEC751, qui présente une sensibilité de 0,0385%/ °C.

Les thermistances sont constituées de matériaux semi-conducteurs et offrent une sensibilité dix fois supérieure à celle du RTD. Les thermistances étant composées de semi-conducteurs, leur plage de température est plus limitée (généralement située entre -80 et 150 °C). Les thermistances établissent des rapports température/résistance non linéaires ; leurs algorithmes de conversion sont donc plus complexes. Les multimètres série Truevolt utilisent l'approximation de Hart-Steinhart standard pour effectuer des conversions précises d'une résolution type de 0,08 °C.

Thermistance requise

Le multimètre numérique convertit la résistance de thermistance mesurée en température à l'aide de l'équation de thermistance de Steinhart-Hart suivante :

$$1/T = A + B (\ln(R)) + C (\ln(R))^3$$

où :

A, B et C sont des constantes fournies par le fabricant de la thermistance et dérivées de trois points de test de température.

R = Résistance de thermistance en Ω .

T = Température en degrés K.

Important : Utiliser uniquement une thermistance de type 44004 de 2,2 k Ω , 44007 de 5 k Ω ou 44006 de 10 k Ω . L'utilisation d'un type de thermistance incorrect peut provoquer des erreurs supérieures à 20 °C pour une température mesurée de 100 °C.

Pour un didacticiel détaillé sur les mesures de température, consultez la note d'application 290 de Keysight intitulée *Mesures de température pratiques*, disponible à l'adresse www.keysight.com.

Mesures en 2 fils et 4 fils

Comme pour les mesures de résistances, les mesures de température en 4 fils offrent une plus grande précision, car les erreurs dues à la résistance des fils de cordons sont entièrement éliminées. Vous pouvez également utiliser la fonction de mesure par rapport à une référence du multimètre pour éliminer la résistance des cordons de test de la mesure (voir la section Lecture NULL (Valeur de référence)).

Lecture NULL (Valeur de référence)

Le multimètre inclut un paramètre distinct de mesure par rapport à une référence qui doit être enregistré pour la fonction de température. Lors de la réalisation de mesures par rapport à une valeur de référence, chaque lecture correspond à la différence entre une valeur de référence stockée et le signal d'entrée. Le paramètre NULL peut être appliqué pour accroître la précision des mesures de résistance en 2 fils en annulant d'abord la résistance des cordons de test en circuit fermé.

Activation/désactivation du réglage automatique du zéro

L'activation de la fonction de réglage automatique du zéro (ON) offre une plus grande précision. Cependant, la mesure supplémentaire (du zéro) réduit la vitesse de lecture.

Réalisation de mesures en courant alternatif haut débit

Les fonctions de voltmètre et d'ampèremètre en courant alternatif du multimètre numérique mettent en œuvre trois filtres à basse fréquence. Ces filtres vous permettent de renoncer à une fréquence mesurée minimum au profit d'une vitesse de lecture accrue. Le filtre RAPIDE se stabilise en 0,025 seconde ; il est utile pour les fréquences supérieures à 200 Hz. Le filtre MOYEN se stabilise en 0,625 seconde pour la tension et en 0,25 seconde pour le courant, et est utile pour les mesures supérieures à 20 Hz. Le filtre LENT se stabilise en 2,5 secondes pour la tension et en 1,66 seconde pour le courant, et est utile pour les fréquences supérieures à 3 Hz.

Avec quelques précautions, vous pouvez effectuer des mesures en courant alternatif à des vitesses supérieures à 500 lectures par seconde. Utilisez la fonction de commutation manuelle pour éliminer les retards dus à la commutation automatique. En définissant le déclenchement retardé à 0, les filtres RAPIDE, MOYEN et LENT permettent d'effectuer jusqu'à 500, 150 et 50 lectures par seconde, mais avec une précision réduite car il est possible que le filtre ne se stabilise pas complètement. Si les niveaux d'échantillon à échantillon sont semblables, le temps de stabilisation nécessaire à chaque nouvelle lecture est réduit. Dans ces conditions, il est possible d'obtenir des résultats moins précis à raison de 20 lectures par seconde avec le filtre MOYEN et de 200 lectures par seconde avec le filtre RAPIDE.

Filtre CA	Bande passante du filtre	Temps de stabilisation (s)		Stabilisation totale (lectures/s)		Stabilisation partielle	Nombre maximal de lectures/s
		V CA	I CA	V CA	I CA	V CA/I CA	V CA/I CA
Lent	3 Hz	2,5	1,67	0,4	0,6	2	50
Moyen	20 Hz	0,63	0,25	1,6	4	20	150
Rapide	200 Hz	0,025	0,025	40	40	200	500

Dans les applications où les niveaux d'échantillon à échantillon varient considérablement, mais où le niveau de décalage de tension continue ne change pas, le filtre MOYEN se stabilise à 2 à 4 lectures par seconde (selon la composante fréquentielle la plus basse du signal) comme indiqué dans le tableau suivant :

Composante fréquentielle la plus basse	20 Hz	50 Hz	100 Hz	200 Hz
Courant alternatif (taux de lectures autorisées/s)	4	4	4	4
Tension alternative (taux de lectures autorisées/s)	2	3	4	4

Pour la tension alternative, un temps de stabilisation supplémentaire peut être nécessaire lorsque le niveau de tension continue varie d'un échantillon à un autre. Les délais d'échantillonnage par défaut permettent une variation du niveau de tension continue de 3 % de la plage pour tous les filtres. Si le changement du niveau de tension continue dépasse ces niveaux, un temps de stabilisation supplémentaire est nécessaire. Le circuit de blocage de la composante continue inclus dans le multimètre numérique a une constante de temps de stabilisation de 0,2 seconde. Ce temps de stabilisation n'affecte la précision de mesure que si les niveaux de décalage de la tension continue varient d'un échantillon à un autre. Si vous recherchez une vitesse de mesure maximale, il est préférable d'ajouter un circuit externe de blocage de composante continue aux voies à tension continue élevée. Ce circuit de blocage peut être simplement constitué d'une résistance et d'un condensateur.

Pour le courant alternatif, un temps de stabilisation supplémentaire n'est pas nécessaire lorsque le niveau de tension continue varie d'un échantillon à un autre.

Réalisation de mesures en courant continu et de résistance haut débit

Si vous disposez de l'option (de numérisation) DIG, sélectionnez simplement **[Acquire] > Digitize** pour sélectionner les mesures V CC ou I CC les plus rapides. Si vous ne possédez pas l'option DIG ou pour les mesures de résistance, pour effectuer des mesures en courant continu ou de résistance ultra rapides (mais moins précises) :

- Réglez le temps d'intégration (NPLC ou ouverture) à la valeur minimale
- Sélectionnez une plage de mesure fixe (commutation automatique de plage désactivée)
- Désactivez le réglage automatique du zéro
- Désactivez la compensation de décalage (mesures de résistance)

Pour plus d'informations sur les fonctions ci-dessus, reportez-vous au type de mesure en question dans la section **Mesures**.

Capacité

Le multimètre effectue des mesures de capacité en appliquant un courant connu pour charger la capacité, puis une résistance pour la décharger, comme indiqué ci-dessous :

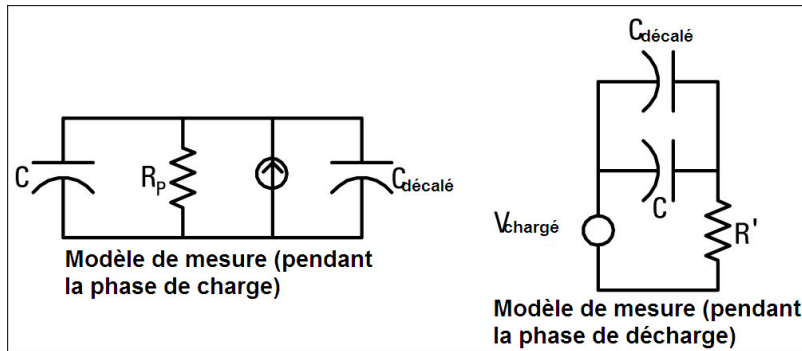

Une illustration de la courbe de réponse pendant le cycle de charge est présentée ci-dessous :

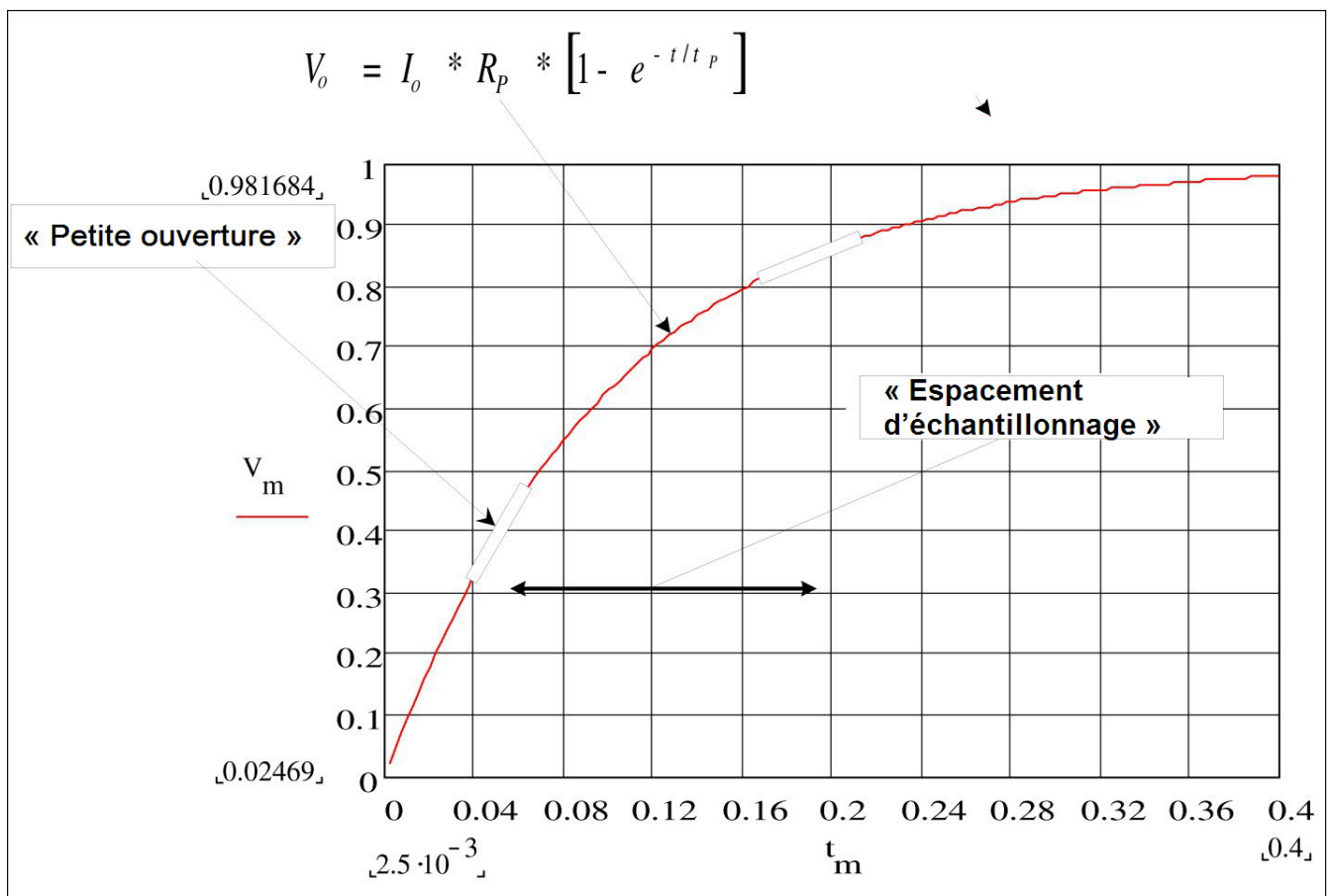

La capacité est calculée en mesurant la variation de tension (DV) qui produit sur un temps d'« ouverture court », (Dt). Cette mesure est répétée à deux périodes différentes pendant la montée exponentielle qui se produit. Un algorithme sélectionne les données de ces quatre points, et en linéarisant cette montée exponentielle sur ces « ouvertures courtes », il calcule avec précision la valeur de capacité.

Le cycle de mesure comprend deux parties : une phase de charge (indiquée dans le graphique) et une phase de décharge. La constante de temps pendant la phase de décharge est plus longue, en raison d'une résistance protectrice de 100 k Ω dans le chemin de mesure. Cette constante joue un rôle important dans la fréquence de lecture résultante (temps de mesure). Les temps incrémentiels (ou « durées d'échantillonnage ») ainsi que la largeur des « ouvertures courtes » varient en fonction de la plage afin de minimiser le bruit et d'augmenter la précision de lecture.

Pour une précision optimale, effectuez une mesure par rapport à une valeur de référence zéro à l'aide de sondes ouvertes, afin de neutraliser la capacité des cordons de tests, avant de débrancher les sondes sur le condensateur à mesurer (pour plus de détails, voir [Mesures de capacité](#)).

Considérations relatives aux mesures de capacité

Les condensateurs qui présentent un facteur de dissipation élevé ou d'autres caractéristiques non-idéales affecteront les mesures de capacité. Les condensateurs à facteur de dissipation élevé peuvent afficher un écart entre la valeur mesurée à l'aide du multimètre et la méthode de fréquence unique de certains autres multimètres LCR. On observe également une variation plus importante à différentes fréquences avec la méthode de fréquence unique. Par exemple, lorsqu'ils sont mesurés avec le multimètre, certains boîtiers de substitution économiques présentent des différences approximatives de 5 % par rapport à la même capacité mesurée avec la méthode de fréquence unique d'un multimètre LCR. Le multimètre LCR présente également différentes valeurs à différentes fréquences.

Les condensateurs à constante de temps longue (absorption diélectrique) affichent un temps de stabilisation de mesure lent et mettent plusieurs secondes à se stabiliser. On observe ce phénomène en connectant d'abord un condensateur ou lorsque le délai de réalisation d'une mesure varie. Un condensateur à couche de haute qualité affiche généralement la valeur la plus basse et un condensateur électrolytique la valeur la plus élevée, avec habituellement des condensateurs céramiques entre les deux.

Numérisation de mesures

Le mode numérisation concerne uniquement les modèles 34465A/70A équipés de l'option DIG et est uniquement disponible sur le panneau avant du multimètre numérique. Le mode numérisé fournit une interface utilisateur de panneau avant qui vous permet de configurer rapidement les mesures numérisées.

La numérisation est un processus consistant à convertir un signal analogique continu, par exemple une onde sinusoïdale en série d'échantillons discrets (lectures). La figure ci-dessous illustre le résultat de numérisation d'une onde sinusoïdale. Ce chapitre décrit les diverses méthodes de numérisation de signaux, l'importance de la fréquence d'échantillonnage et comment utiliser le déclenchement par niveau.

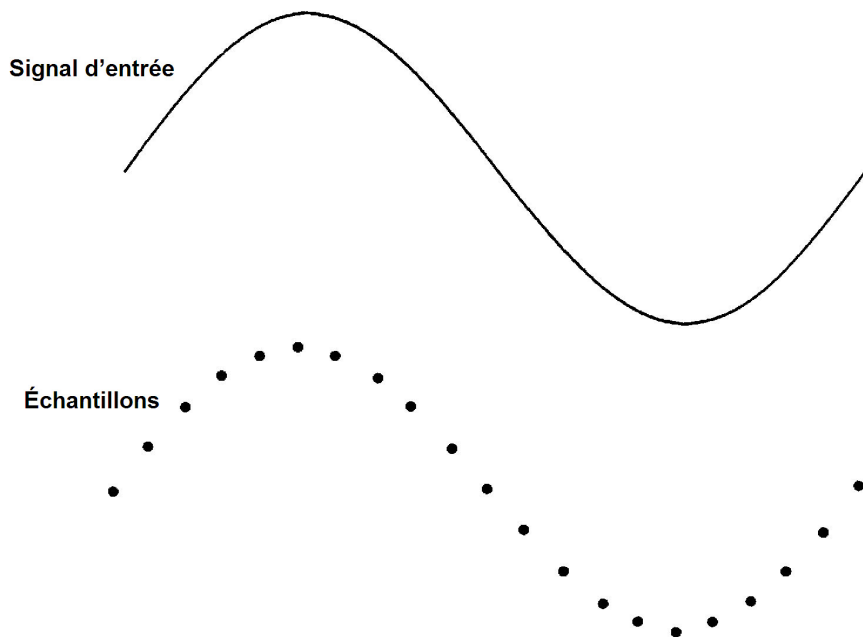

La fréquence d'échantillonnage

Le théorème d'échantillonnage de Nyquist ou d'échantillonnage établit ce qui suit : *Si un signal continu à limitation de bande passante ne contient aucun composant de fréquence supérieur à F , le signal d'origine peut être récupéré sans distorsion (repliement) s'il est échantillonné à une fréquence supérieure à $2F$ échantillons par seconde.*

En pratique, la fréquence d'échantillonnage du multimètre numérique doit être supérieure à deux fois le composant de fréquence le plus élevé du signal mesuré. Dans le panneau avant, vous pouvez sélectionner une fréquence d'échantillonnage en échantillons par seconde à l'aide de la touche de fonction **Sample Rate**. Vous pouvez également définir la fréquence d'échantillonnage indirectement en spécifiant l'intervalle d'échantillonnage (temps entre le début d'un échantillon et le début de l'échantillon suivant) à l'aide de la touche de fonction **Sample Interval**.

La figure ci-dessous illustre une onde sinusoïdale échantillonnée à une fréquence légèrement inférieure à $2F$. Comme illustré par la ligne pointillée, le résultat est une fréquence de repliement considérablement

différente de la fréquence du signal mesurée. Certains numériseurs utilisent un filtre passe-bas anti-repliement avec une coupure nette égale à $1/2$ de la fréquence d'échantillonnage du numériseur. Cela limite la bande passante du signal d'entrée afin d'empêcher le repliement. Étant donné que la fréquence d'échantillonnage du multimètre est variable pour la numérisation de la tension continue et dans le but de préserver la bande passante supérieure pour les mesures de hautes fréquences, aucun filtre anti-repliement n'est intégré au multimètre. Si le repliement vous pose problème, vous devez ajouter un filtre anti-repliement externe.

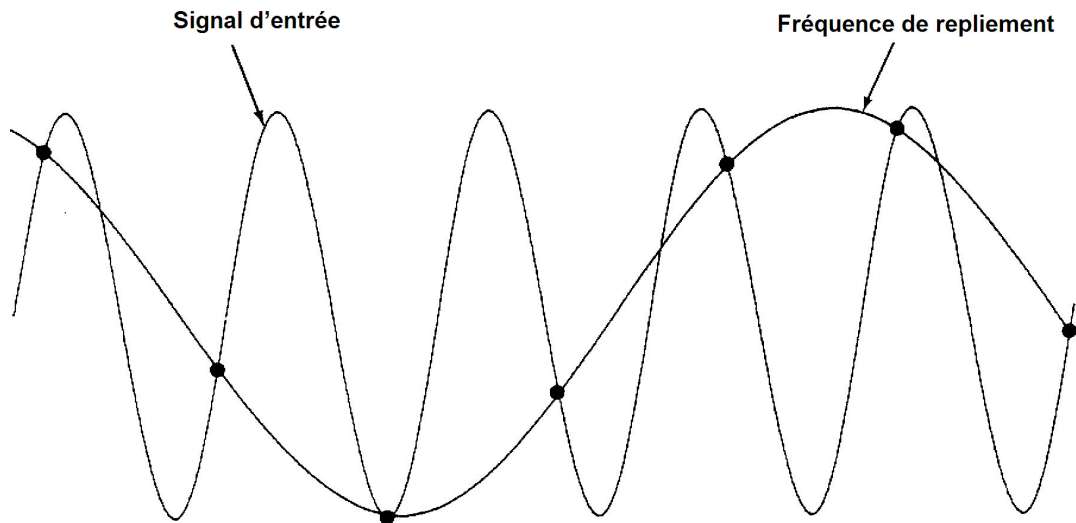

Déclenchement par niveau

Lors de la numérisation, il est important de démarrer l'échantillonnage en un point précis du signal d'entrée, par exemple lorsque le signal franchit la barre des zéro volts ou lorsqu'il atteint le point médian de son amplitude de crête positive ou négative. Le déclenchement par niveau vous permet de spécifier à quel moment (par rapport à la tension et la pente) lancer l'échantillonnage. Pour de plus amples informations, reportez-vous à la section [Déclenchement par niveau](#).

À propos du mode Numérisation

- La numérisation est uniquement disponible sur les modèles 34465A/70A et requiert l'option DIG.
- Elle vous permet de prélever des échantillons du signal d'entrée à une fréquence d'échantillonnage (par exemple, 50 kHz) ou un intervalle d'échantillonnage (par exemple, 20 μ S) donnés. Vous pouvez spécifier la durée sous forme de temps ou de nombre de mesures (échantillons). Vous pouvez utiliser un déclenchement automatique, externe ou par niveau. Après avoir appuyé sur **[Acquire]**, appuyez sur **Acquire > Digitize**. Vous pouvez ensuite sélectionner les paramètres de numérisation/déclenchement. Après avoir configuré les paramètres de numérisation, appuyez sur **[Run/Stop]**. La numérisation démarre lorsque l'événement de déclenchement indiqué se produit.
- Le mode Numérisation est uniquement disponible à partir du panneau avant et ne peut être utilisé que pour les fonctions de mesure V CC ou I CC.

- Lorsque vous spécifiez des paramètres de numérisation en conflit avec les paramètres actuels, l'instrument affiche un message et dans la plupart des cas, rétablit les paramètres à leurs valeurs par défaut. Par exemple, si vous configurez la numérisation pour une fréquence d'échantillonnage supérieure à celle qui peut être atteinte avec le temps d'intégration actuel (paramètre NPLC), l'instrument affiche un message et réduit le temps d'intégration. Lorsqu'un message s'affiche à l'écran, par exemple *NPLC setting reduced to achieve digitize rate/interval* (Paramètre NPLC réduit pour atteindre une fréquence/un intervalle de numérisation), vous pouvez appuyer sur **Shift > Help > 1 View the last message displayed > Select** pour afficher des informations complémentaires.
- L'option DIG permet d'augmenter les vitesses de lecture maximales de 5 000 lectures/s (standard) à 50 000 lectures/s(maximum).
- Elle active les fonctions de pré-déclenchement, de déclenchement par niveau et de retard de déclenchement.
- Avec l'option DIG, les fonctions de déclenchement par niveau, de pré-déclenchement et de temporisateur d'échantillonnage sont activées lors de l'utilisation du multimètre numérique à distance. Sur le panneau avant, le déclenchement par niveau est disponible pour la numérisation et certaines mesures de fonction en mode continu (pour de plus amples informations, reportez-vous à la section **Déclenchement par niveau**). Les commandes du panneau avant de pré-déclenchement sont uniquement disponibles en mode Numérisation. Les commandes du temporisateur d'échantillonnage sont disponibles sur le panneau avant pour tous les modes de mesure.
- Pour le pré-déclenchement, si un déclenchement survient avant que tous les pré-déclenchements ne soient reçus, le déclenchement est exécuté pour lancer les mesures.
- Lors de la numérisation, le message **Digitizing** (Numérisation) clignote dans la partie supérieure de l'affichage. Lorsque l'acquisition est arrêtée, le message **Digitize Stopped** (Numérisation arrêtée) est affiché. Lors de la numérisation, le temps restant et les échantillons restants sont affichés au bas de l'affichage.

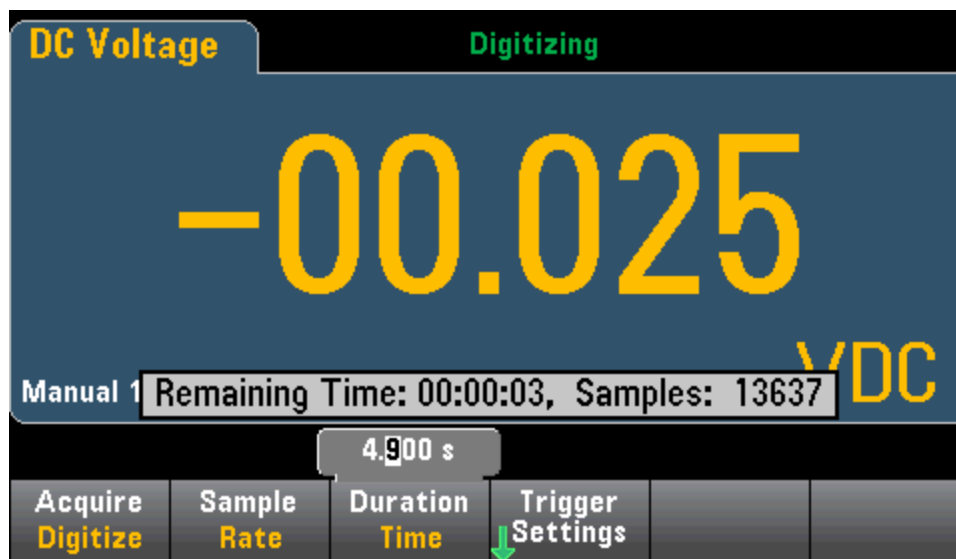

- Tous les échantillons prélevés lors de la numérisation sont enregistrés en mémoire volatile. Une fois l'opération de numérisation terminée, appuyez sur la touche de fonction **Save Readings** et spécifiez un fichier dans lequel enregistrer les mesures numérisées.
- Le nombre maximal de mesures pouvant être capturées varie selon l'espace disponible de la mémoire volatile.
- La banque de lecture est effacée au début d'une nouvelle acquisition.

- La fréquence d'échantillonnage la plus basse pour la numérisation est de 20 ms (1 PLC) ; la fréquence la plus basse est de 19.953 μ s/50.118 kHz (.001 PLC).
- Vous pouvez définir n'importe quel mode d'affichage pour visualiser les données pendant l'acquisition. Cependant, la réactivité aux vues de données risque d'être lente tant que l'acquisition des données n'est pas terminée. Une fois l'acquisition terminée, le diagramme de tendance, les fonctions de panoramique/zoom et les curseurs peuvent être utilisés pour examiner les données.
- Les statistiques et les données de l'histogramme sont calculées une fois la numérisation terminée.

Interaction locale/à distance avec l'enregistrement de données et la numérisation

MISE EN GARDE

Une perte de données est possible. La transition du mode local au mode de commande à distance entraîne un effacement de la mémoire de l'instrument : Lors de l'enregistrement ou de la numérisation de données *en mémoire*, si vous accédez à l'instrument à distance (envoi d'une commande SCPI ou courante)* et que vous repassez en mode local (en appuyant sur [Local]), les lectures sont effacées de la mémoire et l'instrument repasse en mode Continu.

Pour l'enregistrement de données uniquement, vous pouvez éviter cette situation en enregistrant les données dans un fichier plutôt qu'en mémoire (pour plus de détails, voir **Mode Enregistrement de données**). Vous pouvez également empêcher cette situation pour la numérisation ou l'enregistrement des données en suivant la procédure pour que l'instrument ne soit pas accessible à distance. Pour empêcher l'accès à distance, vous pouvez déconnecter les câbles d'interface LAN, GPIB et USB de l'instrument avant de lancer les mesures. Pour éviter tout accès à distance via le réseau local, vous pouvez connecter l'instrument derrière un routeur. Vous pouvez également désactiver les différentes interfaces E/S des menus du panneau avant sous [Utility] > I/O Config.

Pour afficher l'état d'un enregistrement de données ou d'une opération de numérisation à distance, utilisez l'**interface utilisateur Web** de l'instrument. L'écran de l'interface utilisateur Web de l'instrument ne permet pas de paramétrer l'instrument en mode de commande à distance.

**Si l'accès est effectué à distance, l'instrument poursuit la numérisation ou l'enregistrement des données jusqu'à la fin et vous pouvez récupérer les lectures depuis l'interface de commande à distance.*

Mode Enregistrement de données

Le mode Enregistrement de données est disponible de série sur les modèles 34465A et 34470A et uniquement depuis le panneau avant du multimètre. Il inclut une interface utilisateur de panneau avant qui vous permet de configurer l'enregistrement des données dans la mémoire non volatile de l'instrument, ou dans des fichiers internes/externes, sans aucune programmation ni connexion à un ordinateur. Une fois la collecte de données terminée, vous pouvez visualiser ces dernières sur le panneau avant ou bien les transférer vers l'ordinateur. Le mode Enregistrement de données vous permet de spécifier un certain nombre de mesures, ou des mesures acquises sur une période donnée, dans la mémoire de l'instrument ou dans des fichiers de données internes ou externes.

Pour sélectionner le mode Enregistrement de données, appuyez sur **[Acquire] Acquire > Data Log**. Vous pouvez ensuite sélectionner l'intervalle d'échantillonnage (laps de temps s'écoulant entre les mesures, par exemple, 500 mS), la durée, sous forme de période ou de nombre de mesures, déterminer si l'enregistrement de données doit démarrer après un délai ou à une heure précise de la journée, et si les données doivent être enregistrées en mémoire ou dans des fichiers. Après avoir configuré les paramètres d'enregistrement des données, appuyez sur **[Run/Stop]**. L'enregistrement des données commencera après le délai spécifié ou à l'heure indiquée.

MISE EN GARDE

Une perte de données est possible. La transition du mode local au mode de commande à distance entraîne un effacement de la mémoire de l'instrument : Lors de l'enregistrement ou de la numérisation de données *en mémoire*, si vous accédez à l'instrument à distance (envoi d'une commande SCPI ou courante)* et que vous repassez en mode local (en appuyant sur **[Local]**), les lectures sont effacées de la mémoire et l'instrument repasse en mode Continu.

Pour l'enregistrement de données uniquement, vous pouvez éviter cette situation en enregistrant les données dans un fichier plutôt qu'en mémoire (pour plus de détails, voir **Mode Enregistrement de données**). Vous pouvez également empêcher cette situation pour la numérisation ou l'enregistrement des données en suivant la procédure pour que l'instrument ne soit pas accessible à distance. Pour empêcher l'accès à distance, vous pouvez déconnecter les câbles d'interface LAN, GPIB et USB de l'instrument avant de lancer les mesures. Pour éviter tout accès à distance via le réseau local, vous pouvez connecter l'instrument derrière un routeur. Vous pouvez également désactiver les différentes interfaces E/S des menus du panneau avant sous **[Utility] > I/O Config**.

Pour afficher l'état d'un enregistrement de données ou d'une opération de numérisation à distance, utilisez l'**interface utilisateur Web** de l'instrument. L'écran de l'interface utilisateur Web de l'instrument ne permet pas de paramétrer l'instrument en mode de commande à distance.

**Si l'accès est effectué à distance, l'instrument poursuit la numérisation ou l'enregistrement des données jusqu'à la fin et vous pouvez récupérer les lectures depuis l'interface de commande à distance.*

Fonctions du mode Enregistrement de données

- Le mode Enregistrement de données est disponible pour les mesures en tension et courant continus, en tension et courant alternatifs, de résistance en 2 et 4 fils, de fréquence, de période, de température, de capacité et de rapport. Le mode enregistrement de données n'est pas disponible pour les fonctions continuité ou diode.
- La fréquence maximale de l'enregistrement de données est de 1 000 lectures/s. Remarque : La fréquence de lecture maximale peut être limitée par les paramètres déjà configurés lors de l'accès au mode Enregistrement de données (plus particulièrement les paramètres NPLC pour les mesures en courant continu et de résistance). Dans ce cas, appuyez sur la touche de fonction de mesure (par exemple, V CC) et réduisez la valeur d'ouverture (NPLC ou Temps).
- Les paramètres du mode Enregistrement de données et de mesure interagissent. Ces derniers sont l'intervalle d'échantillonnage, la destination (mémoire ou fichier), la fonction de mesure, le NPLC, l'ouverture, la commutation automatique de plage, le réglage du zéro automatique, la compensation de décalage, le filtre CA, la vérification d'ouverture TC et le temps de porte. Lorsque vous spécifiez des paramètres d'enregistrement de données en conflit avec les paramètres actuels, l'instrument affiche un message et dans la plupart des cas, rétablit les paramètres à leurs valeurs par défaut. Par exemple, si vous configurez l'enregistrement de données pour un nombre de lectures supérieur à celui qui peut être enregistré en mémoire de mesures, l'instrument affiche un message et réduit le nombre maximal de lectures. Lorsqu'un message s'affiche à l'écran, par exemple *The data logging Sample Interval increased* (L'intervalle d'échantillonnage d'enregistrement de données a augmenté), vous pouvez appuyer sur **Shift > Help > 1 View the last message displayed > Select** pour afficher des informations complémentaires.
- La durée maximale d'enregistrement de données est de 100 heures, la durée minimale est de 1 seconde.
- Par défaut, le mode de déclenchement par défaut est Automatique. Les sources de déclenchement par niveau et externe ne sont pas prises en charge pour l'enregistrement de données.

- Lorsque le mode Enregistrement de données est activé, le message **Data Logging** (Enregistrement des données) clignote en haut de l'écran et le temps restant du chemin d'accès au fichier journal (lors d'un enregistrement de données dans un fichier) ainsi que les échantillons restants sont indiqués au bas de l'écran.

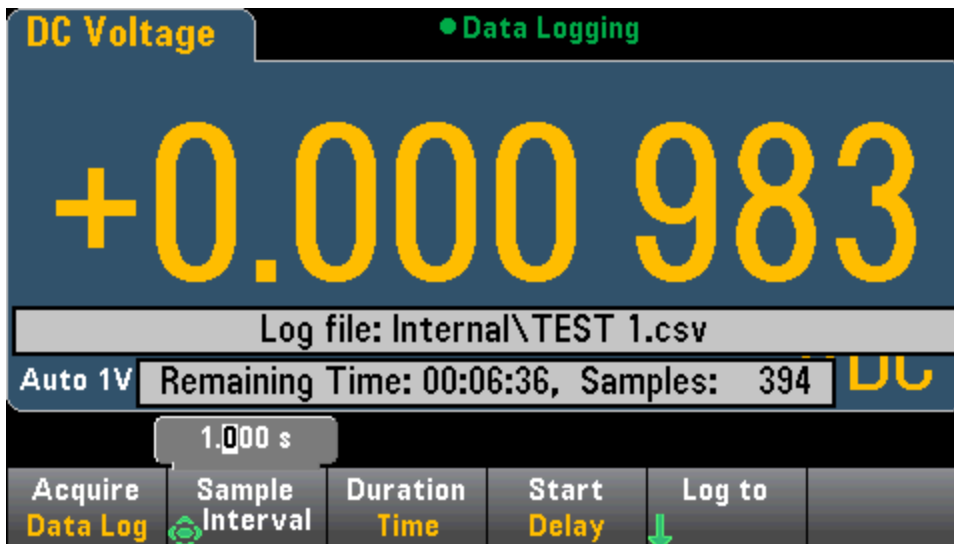

- Vous pouvez stocker les mesures d'enregistrement des données dans la mémoire volatile pour afficher ou écrire les lectures dans un ou plusieurs fichiers.
- Lors de l'enregistrement des données en mémoire, les données sont volatiles (ne sont pas conservées lors de la mise hors tension), mais peuvent être enregistrées dans un fichier interne ou externe une fois l'enregistrement de données terminé. Le nombre de lectures pouvant être enregistrées en mémoire varie selon l'option MEM. Avec l'option MEM, la limite est de 2 000 000 lectures. Sans l'option MEM, la limite est de 50 000 lectures.
- Lors de l'enregistrement des données dans des fichiers :
 - Vous pouvez ajouter la date et l'heure de début d'enregistrement des données au nom de fichier au format suivant : `_YYYYMMDD_HHMMSS`. Par exemple, pour un fichier nommé *Données*, le résultat est similaire à *Données_20140720_032542.csv*.
 - Indiquez si l'enregistrement est interne ou externe et un nom de fichier. Si plusieurs fichiers doivent être créés pour conserver les données, le deuxième nom de fichier portera le suffixe `_0001`, le troisième fichier portera le suffixe `_0002`, etc. En cas d'enregistrement des données dans des fichiers, le nombre maximal de mesures est de 100 heures x 1 000 lectures/s = 360 000 000.

- Comme indiqué dans le graphique du fichier de données d'échantillonnage ci-dessous, lorsque le paramètre **Metadata** est **On**, (voir **Enregistrement de données/Options** pour plus de détails), chaque fichier d'enregistrement de données contient une date et une heure de début indiquant à quel moment la première Lecture a été effectuée, les numéros de lectures, l'intervalle d'échantillonnage et les données de lecture. Vous pouvez spécifier une virgule, un onglet ou un point-virgule comme délimiteur pour séparer les valeurs.

	A	B	C	D	E
1	Start date:	11/6/2014	Start time	31:21.6	
2	Sample interval:	0.59			
3	Reading #	Reading			
4	1	2.12E-05			
5	2	-1.36E-03			
6	3	-2.04E-05			
7	4	-1.99E-05			
8	5	6.53E-06			
9	6	-1.35E-05			
10	7	-1.32E-04			
11	8	-2.32E-05			
12	9	-2.23E-05			
13	10	-2.34E-05			
14	11	-6.93E-06			
15	12	-3.31E-05			
16	13	-1.35E-05			
17	14	-1.07E-05			
18	15	-2.99E-05			
19	16	-1.09E-05			
20	17	3.33E-04			
21	18	-6.88E-05			
22	19	1.19E-05			
23	20	-2.68E-05			

Lorsque le paramètre **Metadata** est désactivé, seules les données de lecture sont enregistrées :

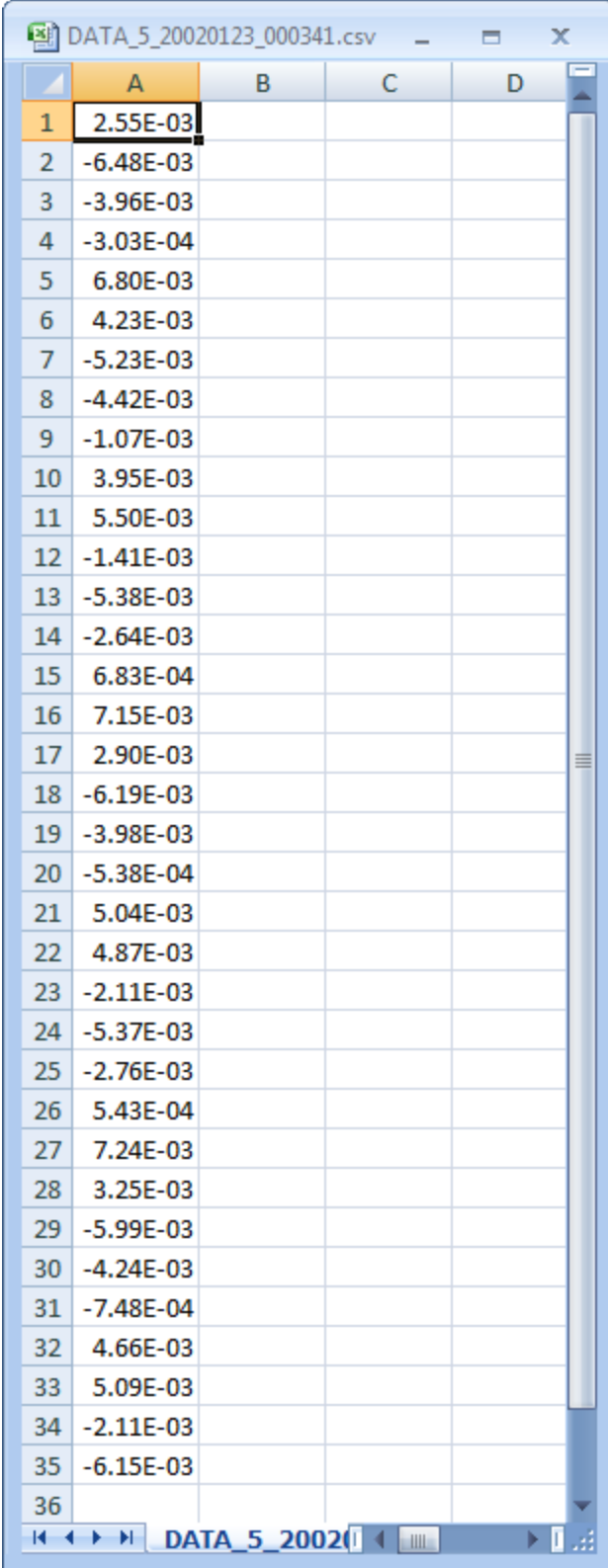

The image shows a spreadsheet window titled "DATA_5_20020123_000341.csv". The spreadsheet has four columns labeled A, B, C, and D. Column A contains 35 rows of data, with the first row highlighted. The values in column A are as follows:

Row	Value
1	2.55E-03
2	-6.48E-03
3	-3.96E-03
4	-3.03E-04
5	6.80E-03
6	4.23E-03
7	-5.23E-03
8	-4.42E-03
9	-1.07E-03
10	3.95E-03
11	5.50E-03
12	-1.41E-03
13	-5.38E-03
14	-2.64E-03
15	6.83E-04
16	7.15E-03
17	2.90E-03
18	-6.19E-03
19	-3.98E-03
20	-5.38E-04
21	5.04E-03
22	4.87E-03
23	-2.11E-03
24	-5.37E-03
25	-2.76E-03
26	5.43E-04
27	7.24E-03
28	3.25E-03
29	-5.99E-03
30	-4.24E-03
31	-7.48E-04
32	4.66E-03
33	5.09E-03
34	-2.11E-03
35	-6.15E-03
36	

Enregistrement de données et affichage du diagramme de tendance

- Lors de l'enregistrement des données en mémoire, le diagramme de tendance associe chaque mesure à un point dans une colonne de pixels, trace une ligne entre plusieurs points dans chaque colonne, et trace une ligne de la dernière mesure d'une colonne vers la première lecture de la colonne suivante.
- Lors de l'enregistrement des données dans un fichier, si l'instrument détermine que les lectures peuvent être contenues en mémoire, le diagramme de tendance se comporte de la même manière que lors d'un enregistrement des données en mémoire. Si le nombre de lectures à enregistrer en mémoire est trop important, le diagramme de tendance se comporte de la même manière qu'en mode de mesure continue. En effet, le nombre de lectures affichées par colonne de pixels varie selon la vitesse de lecture et la fenêtre de temps sélectionnée.

Interaction locale/à distance avec l'enregistrement de données et la numérisation

MISE EN GARDE

Une perte de données est possible. La transition du mode local au mode de commande à distance entraîne un effacement de la mémoire de l'instrument : Lors de l'enregistrement ou de la numérisation de données *en mémoire*, si vous accédez à l'instrument à distance (envoi d'une commande SCPI ou courante)* et que vous repassez en mode local (en appuyant sur **[Local]**), les lectures sont effacées de la mémoire et l'instrument repasse en mode Continu.

Pour l'enregistrement de données uniquement, vous pouvez éviter cette situation en enregistrant les données dans un fichier plutôt qu'en mémoire (pour plus de détails, voir **Mode Enregistrement de données**). Vous pouvez également empêcher cette situation pour la numérisation ou l'enregistrement des données en suivant la procédure pour que l'instrument ne soit pas accessible à distance. Pour empêcher l'accès à distance, vous pouvez déconnecter les câbles d'interface LAN, GPIB et USB de l'instrument avant de lancer les mesures. Pour éviter tout accès à distance via le réseau local, vous pouvez connecter l'instrument derrière un routeur. Vous pouvez également désactiver les différentes interfaces E/S des menus du panneau avant sous **[Utility] > I/O Config**.

Pour afficher l'état d'un enregistrement de données ou d'une opération de numérisation à distance, utilisez l'**interface utilisateur Web** de l'instrument. L'écran de l'interface utilisateur Web de l'instrument ne permet pas de paramétrer l'instrument en mode de commande à distance.

**Si l'accès est effectué à distance, l'instrument poursuit la numérisation ou l'enregistrement des données jusqu'à la fin et vous pouvez récupérer les lectures depuis l'interface de commande à distance.*

Déclenchement par niveau

Le déclenchement par niveau est uniquement disponible sur les modèles 34465A/70A équipés de l'option DIG. Il permet de déclencher des mesures en un point précis du signal d'entrée, par exemple lorsque le signal franchit zéro volts ou lorsqu'il atteint le point central de son amplitude de crête positive ou négative. Par exemple, ce graphique illustre un échantillonnage commençant au point où le signal d'entrée croise 0 V avec une pente positive :

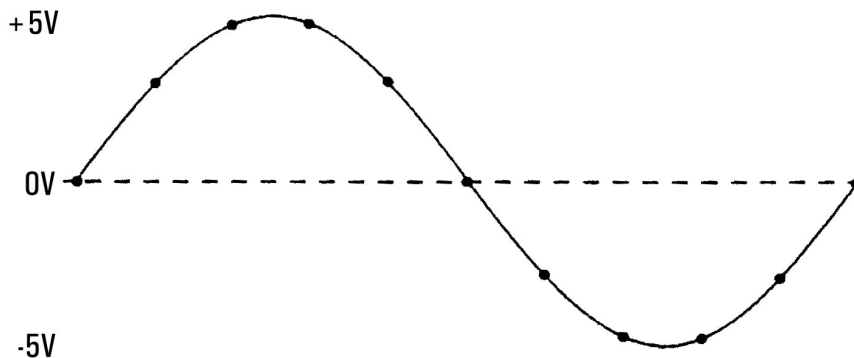

À propos du déclenchement par niveau

Le déclenchement par niveau est disponible pour ces fonctions de mesure :

- Tension continue et courant continu
- Tension alternative et courant alternatif
- Résistance à 2 et 4 fils avec compensation de décalage désactivée, et basse puissance désactivée
- Capteurs de température, RTD ou de thermistance uniquement
- Fréquence et période

Le déclenchement par niveau est sensible aux fronts. En effet, l'instrument doit détecter une *variation* de la quantité mesurée entre un côté du réglage de niveau et l'autre côté (direction déterminée par le paramètre Pente). Par exemple, si la pente est positive, alors la quantité mesurée doit d'abord atteindre une valeur *inférieure* au niveau défini avant qu'un événement de déclenchement ne puisse être détecté.

Les performances de déclenchement par niveau ne sont pas homogènes. Sa précision, sa latence et sa sensibilité dépendent d'autres fonctions du multimètre numérique. Ces dépendances varient selon la fonction de mesure comme décrit ci-dessous.

Considérations relatives à la tension continue, au courant continu et à la résistance à 2 fils :

Ces fonctions de mesure peuvent utiliser un détecteur à réponse rapide intégré au matériel pour des mesures de plage fixe. Pour une latence minimale et une sensibilité maximale, utilisez une plage fixe lors de l'utilisation du déclenchement par niveau. Cependant, la précision du niveau de déclenchement est réduite lorsque le détecteur de matériel est utilisé.

Pour augmenter la précision du niveau de déclenchement et réduire la sensibilité (évités les déclenchements inopportuns en raison du bruit), utilisez la commutation automatique de plage :

- Lorsque la fonction automatique de plage est activée, la précision du niveau de déclenchement et la latence augmentent et la sensibilité diminue car le réglage Ouverture ou NPLC augmente.
- Lorsque la commutation automatique de plage est activée, la précision du niveau de déclenchement et la latence augmentent et la sensibilité diminue si le réglage automatique du zéro est activé.
- Lorsque la commutation automatique de plage est activée, des modifications de la plage peuvent être effectuées pendant le passage du déclenchement, ce qui peut provoquer une latence/incertitude supplémentaires.

Considérations relatives à la résistance à 4 fils et la température

- La précision du niveau de déclenchement et la latence augmentent et la sensibilité diminue car le réglage Ouverture ou NPLC augmente.
- La plage fixe (uniquement disponible pour la résistance) élimine les incertitudes (en raison du changement de plage) en matière de latence de déclenchement.

Considérations relatives à la tension et au courant alternatifs

- La latence de déclenchement augmente et la sensibilité diminue car la bande passante du filtre augmente.
- La latence de déclenchement peut être contrôlée par le paramètre de retard de déclenchement.
- La plage fixe élimine les incertitudes (en raison du changement de plage) en matière de latence de déclenchement.
- Les incertitudes de commutation automatique de plage s'aggravent lorsque la bande passante du filtre augmente.

Considérations relatives à la fréquence et à la période

- La précision du niveau de déclenchement et la latence augmentent et la sensibilité diminue car le temps de porte augmente.
- La plage de tension fixe élimine les incertitudes (en raison du changement de plage) en matière de latence de déclenchement.

Autres sources d'erreur de mesure

Effets du temps de stabilisation

Le multimètre peut introduire des retards de stabilisation de mesure automatiques. Ces retards facilitent les mesures de résistance lorsque la capacité parasite dans les câbles et le composant est inférieure à 200 pF. Ils sont particulièrement importants lorsque vous mesurez des résistances supérieures à 100 kΩ. Le processus de stabilisation dû aux effets de la constante de temps RC peut être relativement long. Certaines résistances de précision, ainsi que certains appareils étalons multifonctions, utilisent des condensateurs parallèles à valeur élevée (de 1 000 pF à 0,1 μF) avec des résistances élevées pour filtrer les courants de bruit injectés par leurs circuits internes. Une capacité non idéale des câbles et d'autres instruments peut imposer des temps de stabilisation plus longs que ceux prévus, à cause des constantes de temps RC dues aux effets d'absorption (diffusion) diélectrique. Les erreurs sont mesurées lors de la stabilisation après la connexion initiale ou un changement de plage.

Erreurs dues à la charge en courant alternatif (tensions alternatives)

Pour la fonction de tension alternative, l'entrée du multimètre apparaît comme une résistance de 1 MΩ en parallèle avec une capacité de 100 pF. Le câblage utilisé pour connecter les signaux au multimètre ajoute également une capacité et une charge. Le tableau ci-dessous décrit la résistance d'entrée approximative du multimètre à diverses fréquences.

Fréquence d'entrée	Résistance d'entrée (kΩ)
100 Hz	941
1 kHz	614
10 kHz	137
100 kHz	15,7

Pour les basses fréquences, l'erreur due à la charge est la suivante :

$$\text{Erreur (\%)} = \frac{-100 \times R_s}{R_s + 1 \text{ M}\Omega}$$

En haute fréquence, l'erreur additionnelle due à la charge est la suivante :

$$\text{Erreur (\%)} = 100 \times \left[\frac{1}{\sqrt{1 + (2 \pi \times F \times R_s \times C_{in})^2}} - 1 \right]$$

R_s = résistance de sortie

F = fréquence d'entrée

C_{in} = capacité d'entrée (100 pF) et capacité du câble

Mesures en-dessous de la pleine échelle

La mesure en courant alternatif atteint son maximum de précision lorsque la lecture du multimètre est au niveau ou proche de la pleine échelle de la plage sélectionnée. La commutation automatique de plage se produit à 10 % (plage inférieure pour toute valeur) et 120 % (plage supérieure pour toute valeur) de la pleine échelle. Ainsi, il vous est possible de mesurer certains signaux d'entrée à la pleine échelle sur une plage et à 10 % de la pleine échelle sur la plage immédiatement supérieure. En règle générale, la précision est plus élevée dans la plage inférieure ; pour une précision optimale, sélectionnez la plage la plus basse possible pour la mesure.

Erreurs dues aux effets d'auto-échauffement haute tension

Si vous appliquez plus de 300 V eff., un auto-échauffement se produit dans les composants de conditionnement des signaux internes du multimètre. Ces erreurs sont incluses dans les spécifications du multimètre. Des variations de température dans le multimètre dues à un effet d'auto-échauffement peuvent provoquer des erreurs supplémentaires sur d'autres plages de tension alternative. L'erreur additionnelle est inférieure à 0,02 % et se dissipe en quelques minutes.

Erreurs de mesure en courant alternatif (chute de tension)

Les erreurs dues à la chute de tension, qui s'appliquent aux mesures en courant continu, concernent également les mesures en courant alternatif. Toutefois, la chute de tension est plus importante pour les mesures en courant alternatif en raison de l'inductance série du multimètre et de vos connexions de mesure. La chute de tension augmente avec la fréquence d'entrée. Certains circuits peuvent se mettre à osciller lors de la réalisation de mesures de courant en raison de l'inductance série du multimètre et de vos connexions de mesure.

Erreurs de mesure de faible niveau

Les mesures en tension alternative inférieures à 100 mV sont particulièrement sensibles aux erreurs introduites par les sources de bruit extérieures. Ainsi, un cordon dont l'extrémité de test reste à l'air se comporte comme une antenne et un multimètre fonctionnant correctement mesurera les signaux captés par cette antenne. La voie de mesure complète, ligne d'alimentation secteur comprise, se comporte comme une antenne cadre. Les courants circulant dans cette antenne cadre créent des tensions d'erreur aux bornes de toutes les impédances en série avec l'entrée du multimètre numérique. Par conséquent, vous devez utiliser des câbles blindés pour appliquer des tensions alternatives de faible niveau au multimètre numérique.

Connectez le multimètre numérique et la source alternative à la même prise électrique chaque fois que possible. Vous devez également réduire la surface des boucles de masse qui ne peuvent pas être évitées. Une source à haute impédance est plus sensible au captage de bruit qu'une source à faible impédance. Vous pouvez réduire l'impédance en haute fréquence d'une source en plaçant un condensateur en parallèle avec les bornes d'entrée du multimètre numérique. Vous devrez peut-être faire plusieurs essais afin de déterminer la valeur correcte de ce condensateur pour votre application.

La plupart des bruits extérieurs ne sont pas corrélés avec le signal d'entrée. Vous pouvez évaluer l'erreur à l'aide de l'équation suivante :

$$\text{Tension mesurée} = \sqrt{V_{\text{in}}^2 + \text{Bruit}^2}$$

Le bruit corrélé, rare, est néanmoins particulièrement néfaste car il s'ajoute toujours directement au signal d'entrée. La mesure d'un signal de faible niveau à la fréquence de l'alimentation secteur est une situation courante qui favorise cette erreur.

Erreurs de mode commun

Des erreurs sont générées lorsque la borne d'entrée LO du multimètre est contrôlée par une tension alternative par rapport à la masse. Le cas le plus fréquent de création de tensions de mode commun inutiles est celui de la connexion « inversée » de la sortie d'un étalonneur de courant alternatif au multimètre. Idéalement, un multimètre lit les valeurs de la même manière, quel que soit le mode de connexion de la source. Les effets de la source et du multimètre peuvent compromettre cette situation idéale. En raison de la capacité entre la borne d'entrée LO et la masse (environ de 200 pF), la source sera soumise à différentes charges, selon le mode d'application de l'entrée. L'étendue de l'erreur dépend de la réponse de la source à cette charge.

S'il bénéficie d'une protection étendue, le circuit de mesure du multimètre numérique répond différemment au cas d'entrée inversée en raison des légères différences observées dans la capacité parasite par rapport à la terre. Les erreurs du multimètre numérique sont plus nombreuses pour les entrées à fréquence et à tension élevées. En règle générale, le multimètre numérique présente une erreur additionnelle d'environ 0,06 % pour une entrée inverse de 100 V, 100 kHz. Vous pouvez utiliser les techniques de mise à la masse décrites dans les problèmes de mode commun de courant continu pour minimiser les tensions de mode commun de courant alternatif.

Erreurs de courant de fuite

La charge de capacité d'entrée du multimètre numérique augmente en raison des courants de polarisation d'entrée lorsque les bornes sont en circuit ouvert (si la résistance d'entrée est de 10 GΩ). Le circuit de mesure du multimètre numérique affiche un courant de polarisation d'entrée d'environ 30 pA pour des températures ambiantes comprises entre 0 et 30 °C. Le courant de polarisation double pour chaque variation de température ambiante de 8 °C au-dessus de 30 °C. Ce courant génère de petits décalages de tension qui varient selon la résistance source du dispositif testé. Cet effet est plus prononcé pour une résistance source supérieure à 100 kΩ, ou lorsque la température de fonctionnement du multimètre numérique est considérablement supérieure à 30 °C.

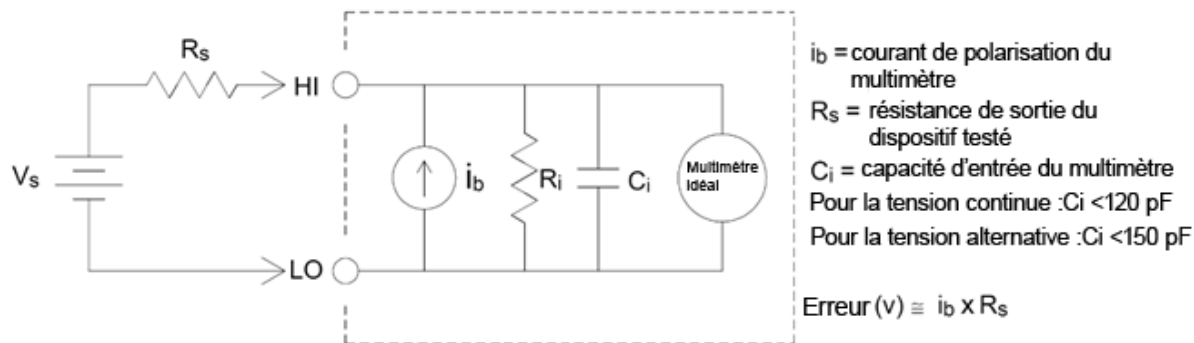

Erreurs de signaux inutiles

Les bornes 3 A et 10 A sont disponibles pour les mesures en courant alternatif et en courant continu. Si des signaux sont appliqués à des bornes non utilisées pour la mesure de courant, des erreurs de mesure peuvent se produire. Les bornes inutilisées sont toujours protégées, mais les signaux supplémentaires peuvent interférer avec les mesures de courant. Par exemple, l'application d'entrées aux bornes 3 A pendant la réalisation de mesures sur les bornes 10 A provoque généralement des erreurs.

Les signaux inutiles appliqués aux bornes de mesure Hi et Lo peuvent également provoquer des erreurs. Les tensions alternatives ou continues supérieures à 15 volts sur les bornes de mesure peuvent provoquer des erreurs de mesure.

Mode de détermination de la fréquence/l'intervalle d'échantillonnage

Le multimètre numérique essaie de définir un intervalle d'échantillonnage supérieur au délai prévu nécessaire pour effectuer les mesures, que ce soit en mode Continu, Enregistrement de données ou Numérisation. De nombreux paramètres interviennent dans le calcul de l'intervalle d'échantillonnage minimal autorisé. Ces paramètres incluent la fonction de mesure, NPLC, l'ouverture, la commutation automatique de plage, le réglage automatique du zéro, la compensation de décalage, le filtre CA, la vérification d'ouverture TC et le temps de porte. Par exemple, lorsque la fonction de commutation automatique de plage est activée, on part du principe qu'un seul changement de plage sera nécessaire. Si plusieurs niveaux de changement se produisent, la mesure peut être retardée et une erreur s'affiche.

Lorsque vous modifiez l'un de ces paramètres, l'intervalle d'échantillonnage (temporisateur d'échantillonnage en mode continu, intervalle d'échantillonnage en mode Enregistrement de données ou Numérisation) est augmenté pour être supérieur au temps de mesure calculé. En mode continu et Enregistrement de données, toute tentative de réduction de l'intervalle d'échantillonnage en-dessous de la valeur calculée entraîne l'affichage d'un message d'erreur. Vous devez ensuite choisir parmi les nombreuses manières de réduire le temps de mesure pour obtenir le plus petit intervalle d'échantillonnage, par exemple en diminuant le paramètre NPLC. Pour la numérisation, l'accent est mis sur des fréquences d'échantillonnage élevées et tous les paramètres, à l'exception de l'ouverture/du NPLC sont fixés pour obtenir un temps de mesure minimum. Les paramètres NPLC et d'ouverture sont automatiquement définis à leurs valeurs minimales lors du passage en mode Numérisation. Si vous définissez les paramètres NPLC ou Ouverture à des valeurs supérieures, l'intervalle d'échantillonnage est augmenté (ou la fréquence d'échantillonnage est réduite) pour rallonger le temps de mesure. Cependant, en mode Numérisation, contrairement aux modes continu et Enregistrement de données, si vous réduisez par la suite l'intervalle d'échantillonnage (ou augmentez la fréquence d'échantillonnage), les paramètres NPLC ou Ouverture seront réduits si nécessaire.

Autrement dit, pour les modes continu et Enregistrement de données, le temporisateur/l'intervalle d'échantillonnage est toujours contrôlé par les autres paramètres de mesure. En mode Numérisation, le temporisateur/l'intervalle d'échantillonnage, le NPLC et l'ouverture sont contrôlés de la même manière ; la modification d'un paramètre peut avoir un impact sur les autres paramètres.

Référence de programmation SCPI

Cette section contient des informations utiles à la programmation des multimètres numériques Keysight Truevolt sur une interface de commande à distance à l'aide du langage de programmation SCPI.

[Présentation du langage SCPI](#)

[Commandes par sous-système](#)

[Aide-mémoire des commandes](#)

[Messages d'erreur SCPI](#)

[État à la mise sous tension/réinitialisation](#)

Informations connexes

Bibliothèques d'E/S et pilotes de l'instrument

Le logiciel Keysight IO Libraries Suite et les instructions d'installation respectives sont disponibles sur le CD-ROM *Keysight Automation Ready CD-ROM* fourni avec votre instrument (en option pour le modèle 34460A).

Documentation de Keysight série Truevolt

La dernière documentation du produit est disponible à l'adresse www.keysight.com/find/truevolt-doc. Pour consulter la documentation des appareils mobiles, rendez-vous sur www.keysight.com/find/truevolt-mobilehelp.

Pour de plus amples informations sur la connexion d'instruments aux interfaces USB, LAN et GPIB, et sur la configuration et le dépannage de ces interfaces, consultez l'aide de Keysight IO Libraries. Vous pouvez télécharger le logiciel Keysight IO Libraries à l'adresse suivante : www.keysight.com/find/iosuite.

Interface Web

Les modèles 34461A/65A/70A et 34460 (équipés de l'option 34460A-LAN ou 3446LANU) intègrent une interface Web. Vous pouvez utiliser cette interface sur un réseau local pour accéder à l'instrument et le contrôler à distance via un navigateur Web. Pour de plus amples informations, reportez-vous à la section [Interface Web](#).

Présentation du langage SCPI

SCPI (Standard Commands for Programmable Instruments) est un langage de programmation ASCII destiné aux instruments de test et de mesure. Les commandes SCPI utilisent une structure hiérarchique appelée système arborescent. Les commandes associées sont regroupées dans un nœud (ou racine) commun pour former un sous-système. Ce langage est illustré dans un échantillon du sous-système SENSE ci-dessous.

SENSe:

VOLTage:

DC:RANGe {<plage>|MIN|MAX|DEF}

DC:RANGe? [MINimum|MAXimum|DEFault]

SENSe est le mot-clé racine de la commande, **VOLTage** est un mot-clé de second niveau et **DC** est un mot-clé de troisième niveau. Le signe des deux points (:) sépare des mots-clés consécutifs.

Conventions syntaxiques

Le format de syntaxe des commandes est illustré ci-dessous :

VOLTage:DC:RANGe {<plage>|MIN|MAX|DEF}

La plupart des commandes (et certains paramètres) forment une combinaison de majuscules et de minuscules. Les majuscules indiquent l'abréviation des commandes, qui génère des lignes de programme plus courtes. Pour une lisibilité accrue des programmes, utilisez la forme complète.

Par exemple, examinons le mot-clé VOLTage, ci-dessus. Vous pouvez saisir VOLT ou VOLTage à l'aide d'une combinaison de majuscules et de minuscules. Par conséquent, VolTaGe, volt et Volt sont tous acceptables. D'autres formes, telles que VOL et VOLTAG génèrent des erreurs.

Les accolades ({ }) entourent les paramètres choisis. Elles ne sont pas envoyées avec la chaîne de caractères des commandes.

Une barre verticale (|) sépare les paramètres choisis. Par exemple, {<plage>|MIN|MAX|DEF} dans la commande ci-dessus indique que vous pouvez spécifier un paramètre de plage numérique, ou « MIN », « MAX » ou « DEF ». La barre n'est pas envoyée avec la chaîne de caractères des commandes.

Les crochets (< >) indiquent que vous devez spécifier une valeur pour le paramètre encadré. Par exemple, l'instruction syntaxique suivante indique le paramètre <plage> entre crochets. N'envoyez pas les crochets avec la chaîne de caractères des commandes. Vous devez spécifier une valeur pour le paramètre (ex. "VOLT:DC:RANG 10") sauf si vous sélectionnez l'une des autres options indiquées dans la syntaxe (ex. "VOLT:DC:RANG MIN").

Les paramètres facultatifs sont entourés de crochets ([]). Les crochets ne sont pas envoyés avec la chaîne de caractères des commandes. Si vous ne spécifiez pas de valeur pour un paramètre facultatif, l'instrument utilise une valeur par défaut.

Séparateurs de commandes

Le signe des deux points (:) sépare des mots-clés consécutifs. Vous devez insérer un espace pour séparer un paramètre d'un mot-clé de commande. Si une commande requiert plusieurs paramètres, vous devez les séparer par une virgule :

```
CONF:VOLT:DC 10,0.003
```

Le point virgule (;) sépare les commandes dans un même sous-système et minimise la frappe. Par exemple, la chaîne de caractères suivante :

```
TRIG:SOUR EXT;COUNT 10
```

équivalent aux deux commandes suivantes :

```
TRIG:SOUR EXT
TRIG:COUNT 10
```

Utilisez deux points et un point virgule pour relier les commandes de différents sous-systèmes. Par exemple, dans l'exemple suivant, une erreur est générée si vous n'utilisez pas les deux points et le point virgule :

```
TRIG:COUN MIN;:SAMP:COUN MIN
```

Utilisation des paramètres MIN, MAX et DEF

Pour de nombreuses commandes, vous pouvez remplacer un paramètre par « MIN » ou « MAX » et par « DEF » dans certains cas. Par exemple, examinons l'exemple suivant :

```
VOLTage:DC:RANGe {<plage>|MIN|MAX|DEF}
```

À la place d'une valeur donnée pour le paramètre <plage>, vous pouvez remplacer MIN pour définir la plage à sa valeur minimale, MAX pour définir la plage à sa valeur maximale ou DEF pour définir la plage à sa valeur par défaut.

Référence de programmation SCPI

Requêtes sur les paramètres

Vous pouvez rechercher la valeur actuelle de la plupart des paramètres en ajoutant un point d'interrogation (?) à la commande. Par exemple, l'exemple suivant illustre la configuration du nombre de déclenchements sur 10 mesures :

```
TRIG:COUN 10
```

Vous pouvez ensuite rechercher le nombre avec la commande suivante :

```
TRIG:COUN?
```

Vous pouvez également rechercher le nombre minimal et maximal autorisé :

```
TRIG:COUN? MIN  
TRIG:COUN? MAX
```

Caractères de fin de commande SCPI

Une chaîne de commande envoyée à l'instrument doit se terminer par un caractère <nouvelle ligne> (<NL>) (décimale ASCII 10). Le message IEEE-488 EOI (End-Or-Identify) est interprété comme le caractère <NL> et peut s'utiliser pour terminer une commande à la place du caractère <NL>. Le <retour chariot> suivi d'un caractère <NL> est également accepté. Le caractère de fin de commande réinitialise toujours le chemin de la commande SCPI au niveau racine.

REMARQUE Pour chaque message SCPI qui comporte une requête et est envoyé à l'instrument, celui-ci termine la réponse retournée par un caractère <NL> ou un caractère de fin de ligne (EOI). Par exemple, si R? est envoyé, la réponse se termine par <NL> après le bloc de données qui est renvoyé. Si un message SCPI comporte plusieurs requêtes séparées par des points virgules (par ex., "ROUTE:TERMinals?;R?"), la réponse renvoyée se termine à nouveau par le caractère <NL> après la réponse à la dernière requête. Dans tous les cas, le programme doit lire ce caractère <NL> dans la réponse avant d'envoyer une autre commande à l'instrument, faute de quoi une erreur se produit.

Commandes courantes IEEE-488.2

La norme IEEE-488.2 définit un ensemble de commandes qui exécutent des fonctions telles que la réinitialisation, les autotests et l'état de l'instrument. Les commandes courantes commencent toujours par un astérisque (*), sont composées de trois caractères et peuvent inclure un ou plusieurs paramètres. Le mot-clé d'une commande est séparé du premier paramètre par un espace. Utilisez un point virgule (;) pour séparer plusieurs commandes, comme indiqué ci-dessous :

```
*RST; *CLS; *ESE 32; *OPC?
```

Types de paramètres SCPI

Le langage SCPI définit plusieurs formats de données à utiliser dans les messages de programmes et de réponses.

Paramètres numériques

Les commandes qui nécessitent des paramètres numériques acceptent toutes les notations décimales courantes des nombres, y compris les signes facultatifs, les points décimaux et la notation scientifique. Les valeurs spéciales de paramètres numériques telles que MIN, MAX et DEF sont également acceptées. Vous pouvez également envoyer des suffixes d'unités techniques (ex. M, k, m ou u). Si une commande accepte uniquement certaines valeurs, l'instrument arrondit automatiquement les paramètres numériques d'entrée aux valeurs acceptées. La commande suivante requiert un paramètre numérique pour la plage :

```
VOLTage:DC:RANGe {<plage>|MIN|MAX|DEF}
```

REMARQUE Comme l'interpréteur SCPI distingue les majuscules et les minuscules, il existe une confusion sur la lettre « m » (ou « m »). Par commodité, l'instrument interprète « mV » (ou « MV ») comme des millivolts, mais « MHZ » (ou « mhz ») comme des mégahertz. De même, « MΩ » (ou « mΩ ») est interprété comme des mégohms. Vous pouvez utiliser le préfixe « MA » pour méga. Par exemple, « MAV » est interprété comme des mégavolts.

Paramètres discrets

Les paramètres discrets permettent de programmer des réglages ayant un nombre limité de valeurs (par ex., IMMEDIATE, EXTERNAL ou BUS). Ils possèdent une forme abrégée et une forme complète comme les mots-clés des commandes. Vous pouvez combiner des majuscules et des minuscules. Les réponses aux requêtes renvoient toujours la forme abrégée en majuscules. La commande suivante requiert un paramètre discret pour les unités de température :

```
UNIT:TEMPerature {C|F|K}
```

Paramètres logiques (booléens)

Les paramètres logiques représentent une condition binaire exclusivement vraie ou fausse. Pour une condition fausse, l'instrument accepte « OFF » ou « 0 ». Pour une condition vraie, l'instrument accepte « ON » ou « 1 ». Lorsque vous effectuez une requête sur un paramètre logique, l'instrument renvoie toujours « 0 » ou « 1 ». La commande suivante requiert un paramètre logique :

```
DISPlay:STATe {ON|1|OFF|0}
```

Paramètres de chaînes de caractères ASCII

Les paramètres de chaînes de caractères peuvent pratiquement contenir n'importe quelle combinaison de paramètres ASCII. Une chaîne de caractères doit commencer et se terminer par des guillemets simples ou doubles. Vous pouvez inclure le délimiteur de guillemets dans la chaîne de caractères en le tapant deux fois sans caractères entre eux. La commande suivante utilise un paramètre de chaîne de caractères :

```
DISPlay:TEXT <chaîne de caractères entre guillemets>
```

Par exemple, la commande suivante affiche le message "WAITING..." (En attente...) sur le panneau avant de l'instrument (les guillemets ne sont pas affichés).

```
DISP:TEXT "WAITING..."
```

Vous pouvez également afficher le même message avec des guillemets simples.

```
DISP:TEXT 'WAITING...'
```

Utilisation de Device Clear

Device Clear est un message de bas niveau du bus IEEE-488 que vous pouvez utiliser pour ramener l'instrument à l'état réactif. Différents langages de programmation et cartes d'interface IEEE-488 permettent d'accéder à cette fonction au moyen de commandes uniques propres. Les registres d'état, la file d'erreurs et tous les états de configuration ne sont pas modifiés à la réception d'un message Device Clear.

Device Clear effectue les actions suivantes :

- Si une mesure est en cours, elle est annulée.
- L'instrument revient à l'état de déclenchement « inactif ».
- Les tampons d'entrée et de sortie de l'instrument sont effacés.
- L'instrument est prêt à recevoir une nouvelle chaîne de caractères de commande.
- Une commande superposée, le cas échéant, sera terminée sans message « Operation Complete » (Opération terminée) (s'applique à INIT).

REMARQUE L'utilisation de la commande `ABORt` est la méthode recommandée pour terminer une mesure.

Commandes par sous-système

ABORt

CALCulate:CLEAr[:IMMediate]

Sous-système CALCulate:AVERAge

Sous-système CALCulate:LIMit

Sous-système CALCulate:SCALe

Sous-système CALCulate:SMOothing

CALCulate:TCHart[:STATe]
Sous-système CALCulate:TRANSform:HISTogram
Sous-système CALibration
Sous-système CONFigure
Sous-système DATA
Sous-système DISPlay
FETCh?
Sous-système FORMat
Sous-système HCOPy
Commandes courantes IEEE 488.2
INITiate[:IMMEDIATE]
Sous-système LXI
Sous-système MEASure
Sous-système MMEMory - Commandes de transfert de données
Sous-système MMEMory - Gestion de fichiers de base
Sous-système MMEMory - Fichiers STATe et PREFerence
OUTPut:TRIGger:SLOPe
R?
READ?
ROUTE:TERMinals?
Sous-système SAMPLe
Sous-système [SENSe:]CAPacitance
Sous-système [SENSe:]CURRent
Sous-système [SENSe:]DATA2
Sous-système [SENSe:]{FREQuency|PERiod}
Sous-système [SENSe:]{RESistance|FRESistance}
Sous-système [SENSe:]TEMPerature
Sous-système [SENSe:]VOLTage
Sous-système STATus
Sous-système SYSTem - Commandes de base
Sous-système SYSTem - Configuration des E/S
Sous-système SYSTem:LICense
Sous-système SYSTem:LOCK

Référence de programmation SCPI

TEST:ALL?

Sous-système TRIGger

UNIT:TEMPerature

ABORt

Interrompt une mesure en cours et renvoie l'instrument à l'état de déclenchement inactif.

Paramètre	Renvoi type
(aucun)	(aucun)
Interrompt une mesure en cours :	
ABORt	

- Utilisez cette commande pour interrompre une mesure lorsque l'instrument attend un déclenchement ou pour interrompre une mesure longue ou une série de mesures.

FETCh?

Attendez que les mesures se terminent et copiez toutes les mesures disponibles vers le tampon de sortie de l'instrument. Les mesures sont conservées dans la mémoire de mesures.

Paramètre	Renvoi type
(aucun)	(aucun)
<p>Utilisez FETCh? à l'aide des commandes CONFIgure et de INITiate. La commande INITiate place l'instrument à l'état « en attente de déclenchement », déclenche une mesure lorsque l'entrée Ext Trig du panneau arrière est pulsée (impulsion basse par défaut) et envoie la mesure à la mémoire de mesures. La requête FETCh? transfère la mesure de la mémoire de mesures vers le tampon de sortie de l'instrument.</p> <p>CONF:VOLT:DC 10,0.003 TRIG:SOUR EXT SAMP:COUN 4 INIT FETC?</p> <p>Réponse type : -4.98748741E-01,-4.35163427E-01,-4.33118686E-01,-3.48109378E-01</p>	

- La requête FETCh? n'efface pas les mesures de la mémoire de mesures. Vous pouvez envoyer la requête plusieurs fois pour récupérer les mêmes données.
- Vous pouvez stocker jusqu'à 1 000 mesures dans la mémoire de mesures du modèle 34460A, 10 000 mesures dans celle du modèle 34461A, 50 000 mesures sur le modèle 34465A/70A (sans l'option MEM) ou 2 000 000 mesures sur le modèle 34465A/70A (avec l'option MEM). Si la mémoire de mesures est saturée, les nouvelles mesures remplacent les anciennes mesures enregistrées ; les mesures les plus récentes sont toujours conservées. Aucune erreur n'est générée. Toutefois, le bit Reading Mem Ovfl (bit 14) est défini dans le registre de conditions du registre des données douteuses (voir la section [Présentation du système d'état](#)).
- L'instrument efface toutes les mesures de la mémoire lorsque la configuration de mesure change ou lorsque l'une des commandes suivantes est exécutée : **INITiate**, **MEASure:<fonction>?**, **READ?**, ***RST**, **SYSTem:PRESet**.

INITiate[:IMMediate]

Fait passer le système de déclenchement de l'état « inactif » à l'état « en attente de déclenchement » et efface le jeu de mesures précédant de la mémoire de mesures. Les mesures commencent lorsque les conditions de déclenchement spécifiées sont réunies après la réception de la commande **INITiate**.

Paramètre	Renvoi type
(aucun)	(aucun)
Renvoyer cinq mesures en tension continue à l'aide d'un déclenchement logiciel pour lancer les mesures :	
CONF:VOLT:DC 10,0.003	
TRIG:SOUR BUS	
SAMP:COUN 5	
INIT	
*TRG	
FETC?	

- La procédure d'enregistrement de mesures dans la mémoire de mesures à l'aide de la commande **INITiate** est plus rapide que celle consistant à envoyer des mesures au tampon de sortie de l'instrument avec la commande **READ?** (à condition que vous n'exécutez pas la commande **FETCh?** avant la fin de l'opération). La commande **INITiate** est également une commande « superposée ». Autrement dit, après avoir exécuté la commande **INITiate**, vous pouvez envoyer d'autres commandes qui n'affectent pas les mesures.
- Vous pouvez stocker jusqu'à 1 000 mesures dans la mémoire de mesures du modèle 34460A, 10 000 mesures dans celle du modèle 34461A, 50 000 mesures sur le modèle 34465A/70A (sans l'option MEM) ou 2 000 000 mesures sur le modèle 34465A/70A (avec l'option MEM). Si la mémoire de mesures est saturée, les nouvelles mesures remplacent les anciennes mesures enregistrées ; les mesures les plus récentes sont toujours conservées. Aucune erreur n'est générée. Toutefois, le bit Reading Mem Ovfl (bit 14) est défini dans le registre de conditions du registre des données douteuses (voir la section **Présentation du système d'état**).
- Pour récupérer les mesures de la mémoire de mesures, utilisez la commande **FETCh?**. Utilisez la commande **DATA:REMove?** ou **R?** pour lire et effacer la totalité ou une partie des mesures disponibles.
- Utilisez la commande **ABORt** pour renvoyer l'instrument à l'état inactif.

OUTPut:TRIGger:SLOPe {POSitive|NEGative}
 OUTPut:TRIGger:SLOPe?

Sélectionne la pente du signal de sortie *voltmeter complete* (mesure terminée) sur le connecteur BNC **VM Comp** du panneau arrière.

Paramètre	Renvoi type
{POSitive NEGative}. Valeur par défaut : NEG	POS ou NEG
Configurez les mesures en tension continue et effectuez deux mesures. Le signal sur le connecteur VM Comp du panneau arrière génère une impulsion positive à la fin de chaque mesure : CONF:VOLT:DC 10 SAMP:COUN 2 OUTP:TRIG:SLOP POS INIT	

- Sur le modèle 34460A, l'option 34460A-LAN ou l'option 3446LANU est requise.
- Ce paramètre est défini à sa valeur par défaut après une réinitialisation de la configuration d'usine (***RST**) ou un pré réglage de l'instrument (**SYSTem:PRESet**).

R? [<lectures_max>]

Lit et efface toutes les mesures de la mémoire jusqu'aux <lectures_max> spécifiées. Les mesures sont lues et effacées de la mémoire en commençant d'abord par la mesure la plus ancienne.

Paramètre	Renvoi type
1 à 2 000 000 (lectures) Par défaut, toutes les mesures en mémoire.	(aucun)
Lire et supprimer les trois mesures les plus anciennes :	
R? 3	
Réponse type : #247-4.98748741E-01,-4.35163427E-01,-7.41859188E-01	
La partie « #2 » signifie que les 2 chiffres suivants indiquent le nombre de caractères qui seront contenus dans la chaîne de mémoire renvoyée. Ces deux chiffres sont le 4 et le 7 qui suivent « #2 ». Par conséquent, le reste de la chaîne présente une longueur de 47 chiffres :	
-4.98748741E-01,-4.35163427E-01,-7.41859188E-01	

- Les requêtes **R?** et **DATA:REMove?** peuvent être utilisées au cours d'une longue série de lectures pour supprimer régulièrement des mesures de la mémoire afin d'éviter une saturation de cette dernière. La commande **R?** n'attend pas la fin de toutes les mesures. Elle envoie les mesures terminées au moment où l'instrument reçoit la commande. Utilisez les commandes **Read?** ou **Fetch?** afin que l'instrument attende que toutes les mesures soient terminées avant de les envoyer.
- Si vous ne spécifiez pas de valeur pour <lectures_max>, toutes les mesures sont lues et effacées.
- Aucune erreur n'est générée si la mémoire de mesures contient un nombre de mesures inférieur à celui qui est demandé. Dans ce cas, toutes les mesures disponibles en mémoire sont lues et supprimées.
- Le nombre de mesures renvoyées peut être inférieur à celui qui est demandé en fonction de la quantité de mémoire de mesures de votre instrument. Vous pouvez stocker jusqu'à 1 000 mesures dans la mémoire de mesures du modèle 34460A, 10 000 mesures dans celle du modèle 34461A, 50 000 mesures sur le modèle 34465A/70A (sans l'option MEM) ou 2 000 000 mesures sur le modèle 34465A/70A (avec l'option MEM). Si la mémoire de mesures est saturée, les nouvelles mesures remplacent les anciennes mesures enregistrées ; les mesures les plus récentes sont toujours conservées. Aucune erreur n'est générée. Toutefois, le bit Reading Mem Ovfl (bit 14) est défini dans le registre de conditions du registre des données douteuses (voir la section **Présentation du système d'état**).
- L'instrument efface toutes les mesures de la mémoire lorsque la configuration de mesure change ou lorsque l'une des commandes suivantes est exécutée : **INITiate**, **MEASure:<fonction>?**, **READ?**, ***RST**, **SYSTem:PRESet**.

READ?

Lance une nouvelle série de mesures, attend que toutes les mesures soient terminées et transfère toutes les mesures disponibles. L'envoi de la commande READ? est similaire à l'envoi de la commande **INITiate**, suivi immédiatement de la commande **FETCh?**.

Paramètre	Renvoi type
(aucun)	(aucun)
Transférer des mesures depuis la mémoire de mesures :	
READ?	
Réponse type : -4.98748741E-01,-4.35163427E-01,-4.33118686E-01,-3.48109378E-01	

- La requête **FETCh?** n'efface pas les mesures de la mémoire de mesures. Vous pouvez envoyer la requête plusieurs fois pour récupérer les mêmes données.
- Vous pouvez stocker jusqu'à 1 000 mesures dans la mémoire de mesures du modèle 34460A, 10 000 mesures dans celle du modèle 34461A, 50 000 mesures sur le modèle 34465A/70A (sans l'option MEM) ou 2 000 000 mesures sur le modèle 34465A/70A (avec l'option MEM). Si la mémoire de mesures est saturée, les nouvelles mesures remplacent les anciennes mesures enregistrées ; les mesures les plus récentes sont toujours conservées. Aucune erreur n'est générée. Toutefois, le bit Reading Mem Ovfl (bit 14) est défini dans le registre de conditions du registre des données douteuses (voir la section **Présentation du système d'état**).
- L'instrument efface toutes les mesures de la mémoire lorsque la configuration de mesure change ou lorsque l'une des commandes suivantes est exécutée : **INITiate**, **MEASure:<fonction>?**, **READ?**, ***RST**, **SYSTem:PRESet**.

ROUTe:TERMinals?

Indique les bornes d'entrée sélectionnées sur le commutateur **Front/Rear** (Avant/Arrière) du panneau avant 34461A. Ce commutateur n'est pas programmable ; cette requête signale la position du commutateur, mais ne peut pas la modifier.

AVERTISSEMENT N'activez et ne désactivez pas le commutateur Front/Rear lorsque des signaux sont actifs sur les bornes. Ce commutateur n'est pas conçu pour être utilisé de cette manière et peut être endommagé par des tensions ou des courants élevés qui risqueraient de compromettre les fonctions de sécurité de l'instrument.

Paramètre	Renvoi type
(aucun)	FRON ou REAR
Renvoyer l'état du commutateur Front/Rear :	
ROUT:TERM?	

- Sur le modèle 34460A, cette requête renvoie toujours FRON.

TEST:ALL?

Exécute un autotest de l'instrument et renvoie une indication de réussite/échec. L'autotest **TEST:ALL?** est plus complet que l'autotest ***TST?**.

MISE EN GARDE Vous devez supprimer toutes les connexions d'entrée à l'instrument avant d'effectuer l'autotest complet.

Paramètre	Renvoi type
(aucun)	(aucun)
Exécuter un autotest :	
TEST:ALL?	
Réponse type : +0 (réussite) ou +1 (échec) (un ou plusieurs tests ont échoué)	

- Si un ou plusieurs test échouent, la requête renvoie +1 et enregistre une erreur dans la file d'erreurs. Pour une liste complète des messages d'erreur relatifs aux échecs d'autotest, reportez-vous à la section **Messages d'erreur d'autotest**.
- Une fois le test terminé, l'instrument retourne à l'état précédant l'autotest.

UNIT:TEMPerature {C|F|K}

UNIT:TEMPerature?

Sélectionne les unités (°C, °F ou Kelvin) à utiliser pour toutes les mesures de température, à l'exception de la requête **SYSTem:TEMPerature?**.

Paramètre	Renvoi type
{C F K}. Valeur par défaut : C.	C, F ou K
Effectuer une mesure de RTD en 4 fils et renvoyer le résultat en °F :	
UNIT:TEMP F	
MEAS:TEMP? FRTD	
Réponse type : +6.82320000E+01	

- La commande accepte également CEL ou FAR, mais la requête renvoie C ou F.
- Ce paramètre est défini à sa valeur par défaut après une réinitialisation de la configuration d'usine (***RST**) ou un préréglage de l'instrument (**SYSTem:PRESet**).

Voir également

CONFigure:TEMPerature

MEASure:TEMPerature?

[SENSe:]FUNCTion[:ON]

Sous-système CALCulate - Présentation

Le sous-système CALCulate reçoit des données en temps réel du matériel de mesure et les envoie à la mémoire de mesures. De plus, il réalise éventuellement les opérations mathématiques suivantes, comme indiqué dans le diagramme ci-dessous :

- Lissage
- Réglage d'échelle
- Statistiques
- Vérification des limites
- Histogramme

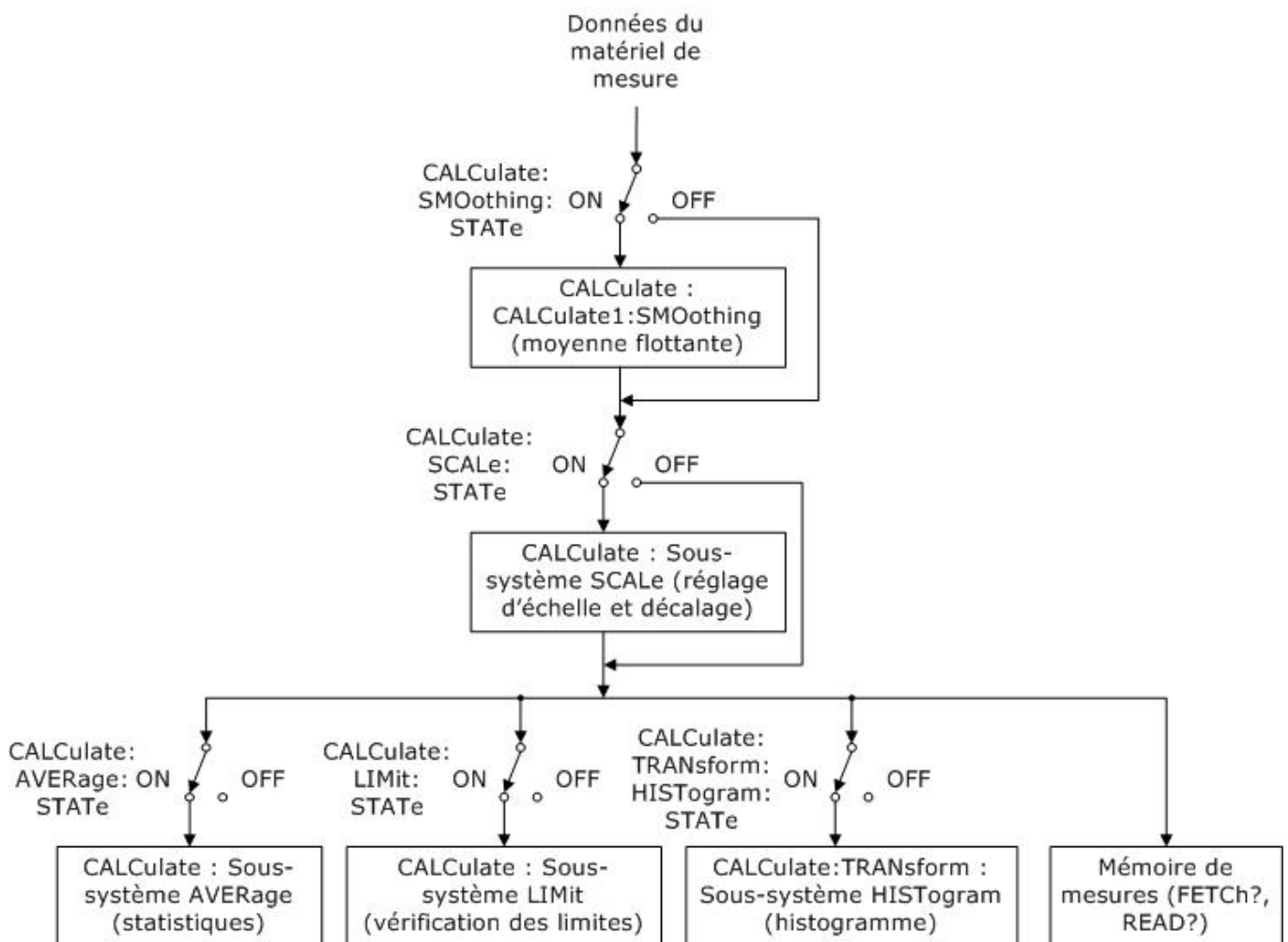

Seuls les calculs activés par **CALC:SCAL:STAT**, **CALC:TRAN:HIST:STAT**, **CALC:LIM:STAT** et **CALC:AVER:STAT** sont effectués.

Composantes du sous-système CALCulate

CALCulate:CLear[:IMMEDIATE]

Sous-système AVERage

Sous-système HISTogram

Sous-système LIMit

Sous-système SCALing

Sous-système SMOothing

CALCulate:CLEar[:IMMEDIATE]

Efface toutes les limites, données d'histogramme, statistiques et mesures.

Paramètre	Renvoi type
(aucun)	(aucun)
Effacer toutes les limites, données d'histogramme, statistiques et mesures : CALC:CLE:IMM	

- Les éléments sont supprimés de façon synchrone ; les données d'histogramme, statistiques et de limite redémarrent toutes en même temps que les mesures.

Sous-système CALCulate:LIMit

Ce sous-système spécifie des mesures et indique si une limite a été dépassée.

Exemple

L'exemple suivant illustre l'activation du test des limites de 100 mesures en tension continue et indique si les mesures étaient hors de la plage 3,2 - 3,4 V. Les mesures supérieures à 3,4 V activeront le bit 12 (Échec limite supérieure) du registre des événements d'état suspect ; les mesures inférieures à 3,2 V activeront le bit 11 (Échec limite inférieure).

```
*CLS
STAT: PRES
CONF: VOLT 10, .001
SAMP: COUN 100
CALC: LIM: LOW 3.2
CALC: LIM: UPP 3.4
CALC: LIM: STAT ON
INIT
*WAI
STAT: QUES?
```

Réponse type : +4096 (au moins une mesure était supérieure à la limite maximale)

Récapitulatif des commandes

CALCulate:LIMit:CLEar[:IMMEDIATE]

CALCulate:LIMit:{LOWer|UPPer}[:DATA]

CALCulate:LIMit[:STATe]

CALCulate:LIMit:CLEar[:IMMediate]

Efface les indications de limites dépassées sur le panneau avant et efface le bit 11 (Échec limite inférieure) et le bit 12 (Échec limite supérieure) dans le registre de conditions du groupe de registres des événements de données douteuses. Les bits de registre d'événements correspondants ne sont pas affectés.

Un registre de conditions surveille en permanence l'état de l'instrument. Les bits du registre de conditions sont mis à jour en temps réel ; ils ne sont ni verrouillés ni mis en mémoire tampon.

Un registre d'événements est un registre en lecture seule qui verrouille des événements du registre de conditions. Lorsqu'un bit d'événement est actif, les événements suivants correspondant à ce bit sont ignorés.

Paramètre	Renvoi type
(aucun)	(aucun)
Effacer les résultats de tests de limites :	
CALC:LIM:CLE	

- Cette commande n'efface pas les mesures de la mémoire de mesures.
- L'instrument efface les indications de limites dépassées sur le panneau avant et efface les bits 11 et 12 dans le registre des données douteuses lorsque la fonction de mesure change ou lorsque l'une des commandes suivantes est exécutée :

CALCulate:LIMit:STATe ON

INITiate

MEASure:<fonction>?

READ?

CALCulate:LIMit:CLEar

***RST**

SYSTem:PRESet

- Pour effacer les statistiques, les limites, les données d'histogramme et les données de mesure, utilisez la commande **CALCulate:CLEar[:IMMediate]**.

CALCulate:LIMit:{LOWer|UPPer}[:DATA] {<valeur>|MIN|MAX|DEF}
CALCulate:LIMit:{LOWer|UPPer}[:DATA]? [{MIN|MAX|DEF}]

Définit une limite supérieure ou inférieure.

Paramètre	Renvoi type
-1.0E+15 à -1.0E-15, ou 0,0 (valeur par défaut) ou +1.0E-15 à 1.0E+15	+1.00000000E+00
Voir l' exemple .	

- Vous pouvez affecter une limite inférieure, une limite supérieure ou les deux. Ne définissez pas la limite inférieure au-dessus de la limite supérieure.
- *Franchissement de limite* : Si une mesure est inférieure à la limite minimale spécifiée, le bit 11 (Échec limite inférieure) est défini dans le registre des conditions de données douteuses. Une mesure supérieure à la limite maximale spécifiée active le bit 12 (Échec limite supérieure). Pour de plus amples informations, reportez-vous à la section [Présentation du sous-système STATus](#).
- La commande **CONFigure** réinitialise les deux limites à 0.
- Ce paramètre est défini à sa valeur par défaut après une réinitialisation de la configuration d'usine (***RST**) ou un préreglage de l'instrument (**SYSTem:PRESet**).

CALCulate:LIMit[:STATe] {ON|1|OFF|0}
CALCulate:LIMit[:STATe]?

Active ou désactive les tests de limites.

Paramètre	Renvoi type
{ON 1 OFF 0}. Valeur par défaut : OFF.	0 (OFF) ou 1 (ON)
Voir l' exemple .	

- L'instrument efface les indications de limites dépassées sur le panneau avant et efface les bits 11 et 12 dans le registre des données douteuses lorsque la fonction de mesure change ou lorsque l'une des commandes suivantes est exécutée :

CALCulate:LIMit:STATe ON

INITiate

MEASure:<fonction>?

READ?

CALCulate:LIMit:CLEar

***RST**

SYSTem:PRESet

- L'instrument désactive ce paramètre après un changement de la fonction de mesure ou l'exécution de la commande ***RST** ou **SYSTem:PRESet**.

Sous-système CALCulate:TRANSform:HISTogram

Le sous-système HISTogram configure l'affichage de l'histogramme. L'instrument efface les données d'histogramme lorsque la fonction de mesure change ou lorsqu'une des commandes suivantes est envoyée :

CALCulate:TRANSform:HISTogram:CLEar[:IMMEDIATE]

CALCulate:TRANSform:HISTogram:POINts

CALCulate:TRANSform:HISTogram:RANGe:AUTO

CALCulate:TRANSform:HISTogram:RANGe:{LOWer|UPPer}

CALCulate:TRANSform:HISTogram[:STATe]

INITiate[:IMMEDIATE]

MEASure:<fonction>?

READ?

*RST

SYSTem:PRESet

Récapitulatif des commandes

CALCulate:TRANSform:HISTogram:ALL?

CALCulate:TRANSform:HISTogram:CLEar[:IMMEDIATE]

CALCulate:TRANSform:HISTogram:COUNT?

CALCulate:TRANSform:HISTogram:DATA?

CALCulate:TRANSform:HISTogram:POINts

CALCulate:TRANSform:HISTogram:RANGe:AUTO

CALCulate:TRANSform:HISTogram:RANGe:{LOWer|UPPer}

CALCulate:TRANSform:HISTogram[:STATe]

Exemple

Cet exemple illustre l'activation d'un histogramme de 100 cases de 1 000 mesures Vcc mis à l'échelle automatiquement. Il renvoie ensuite l'histogramme complet, notamment les valeurs de plage inférieure et supérieure, le nombre total de mesures et les données des cases.

```
CONF:VOLT:DC 10,0.001
SAMP:COUN 1000
CALC:TRAN:HIST:RANG:AUTO ON
CALC:TRAN:HIST:POIN 100
CALC:TRAN:HIST:STAT ON
INIT
*WAI
CALC:TRAN:HIST:ALL?
```

Réponse type : +9.99383828E+00,+1.00513398E+01,+1000,<102 cases>

REMARQUE La réponse ci-dessus indique un nombre de 102 cases car l'histogramme inclut les cases correspondant aux valeurs inférieures et supérieures à la plage d'histogramme.

CALCulate:TRANSform:HISTogram:ALL?

CALCulate:TRANSform:HISTogram:DATA?

La forme ALL de la requête renvoie une liste séparée par des virgules des valeurs de plage inférieure et supérieure, du nombre de mesures, et des données de cases collectées depuis le dernier effacement des données d'histogramme. La forme DATA renvoie uniquement les données des cases.

Paramètre	Renvoi type
(aucun)	Voir l' exemple .
Voir l' exemple .	

- Les données des cases incluent, dans l'ordre :
 - Le nombre de mesures inférieures à la valeur de plage inférieure
 - Le nombre de mesures dans chacune des cases, en commençant à la case de valeur de plage inférieure
 - Le nombre de mesures supérieures à la valeur de plage supérieure
- Les valeurs de plage sont des nombres réels renvoyés au format +1.00000000E+00. Le nombre de mesures et de données de cases sont des entiers positifs signés renvoyés au format +100.

CALCulate:TRANSform:HISTogram:CLEar[:IMMEDIATE]

Efface les données d'histogramme et redémarre la commutation des plages d'histogramme si celle-ci est activée (**CALCulate:TRANSform:HISTogram:RANGe:AUTO ON**).

Paramètre	Renvoi type
(aucun)	(aucun)
Effacer les données d'histogramme :	
CALC:TRAN:HIST:CLE	

- Cette commande n'efface pas les mesures de la mémoire de mesures.
- Pour effacer les statistiques, les limites, les données d'histogramme et les données de mesure, utilisez la commande **CALCulate:CLEar[:IMMEDIATE]**.

CALCulate:TRANSform:HISTogram:COUNT?

Renvoie le nombre de mesures collectées depuis le dernier effacement de l'histogramme.

Paramètre	Renvoi type
(aucun)	+87
Renvoyer le nombre de mesures utilisées pour représenter l'histogramme actuel :	
CALC:TRAN:HIST:COUN?	

CALCulate:TRANSform:HISTogram:POINTs {<valeur>|MIN|MAX|DEF}**CALCulate:TRANSform:HISTogram:POINTs? [{MIN|MAX|DEF}]**

Définit le nombre de cases entre les valeurs de plage inférieure et supérieure de l'histogramme. Deux cases supplémentaires existent toujours : une ou plusieurs mesures inférieures à la plage inférieure et une pour les mesures supérieures à la plage supérieure.

Paramètre	Renvoi type
{10 20 40 100 200 400 MIN MAX DEF}. Valeur par défaut : 100.	+100
Voir l' exemple .	

- Vous pouvez spécifier les valeurs de plage inférieure et supérieure à l'aide de la commande **CALCulate:TRANSform:HISTogram:RANGe:{LOWer|UPPer}**. Les valeurs de plage inférieure et supérieure sont calculées automatiquement si la commande **CALCulate:TRANSform:HISTogram:RANGe:AUTO** est activée.
- Ce paramètre est défini à sa valeur par défaut après une réinitialisation de la configuration d'usine (***RST**) ou un préreglage de l'instrument (**SYSTem:PRESet**).

CALCulate:TRANSform:HISTogram:RANGe:AUTO {ON|1|OFF|0}

CALCulate:TRANSform:HISTogram:RANGe:AUTO?

Active ou désactive la sélection automatique des valeurs de plage inférieure et supérieure de l'histogramme.

Paramètre	Renvoi type
{ON 1 OFF 0}. Valeur par défaut : ON.	0 (OFF) ou 1 (ON)
Voir l' exemple .	

- **ON** : l'instrument utilise les 1 000 premières mesures pour définir les valeurs de plage inférieure et supérieure.
- **OFF** : les valeurs de plage inférieure et supérieure sont spécifiées par la commande **CALCulate:TRANSform:HISTogram:RANGe:{LOWer|UPPer}**.
- La définition de la valeur de plage inférieure ou supérieure (**CALCulate:TRANSform:HISTogram:RANGe:{LOWer|UPPer}**) entraîne la désactivation de la sélection automatique des valeurs de plage inférieure et supérieure (**CALCulate:TRANSform:HISTogram:RANGe:AUTO OFF**).
- L'instrument redémarre la sélection automatique des valeurs de plages (si celle-ci est activée) lorsque les commandes **INITiate**, **MEASure?** ou **READ?** sont exécutées.
- Ce paramètre est défini à sa valeur par défaut après une réinitialisation de la configuration d'usine (***RST**) ou un pré réglage de l'instrument (**SYSTem:PRESet**).

CALCulate:TRANSform:HISTogram:RANGe:{LOWer|UPPer} {<valeur>|MIN|MAX|DEF}

CALCulate:TRANSform:HISTogram:RANGe:{LOWer|UPPer}? [{MIN|MAX|DEF}]

Définit les valeurs de plage inférieure et supérieure de l'histogramme. La définition de la valeur de plage inférieure ou supérieure (**CALCulate:TRANSform:HISTogram:RANGe:{LOWer|UPPer}**) entraîne la désactivation de la sélection automatique des valeurs de plage inférieure et supérieure (**CALCulate:TRANSform:HISTogram:RANGe:AUTO OFF**).

Paramètre	Renvoi type
-1.0E+15 à -1.0E-15, ou 0,0 (valeur par défaut) ou +1.0E-15 à 1.0E+15	+1.00000000E+06
Voir l' exemple .	

- Si la sélection automatique des valeurs de plage est activée (**CALCulate:TRANSform:HISTogram:RANGe:AUTO ON**), la requête renvoie la valeur de plage calculée. Si aucune donnée d'histogramme n'existe, 9.91E37 (et non un nombre) est renvoyé.
- Les valeurs de plage inférieure et supérieure sont calculées automatiquement si la commande **CALCulate:TRANSform:HISTogram:RANGe:AUTO** est activée.
- Ce paramètre est défini à sa valeur par défaut après une réinitialisation de la configuration d'usine (***RST**) ou un pré réglage de l'instrument (**SYSTem:PRESet**).

CALCulate:TRANSform:HISTogram[:STATe] {ON|1|OFF|0}
CALCulate:TRANSform:HISTogram[:STATe]?

Active ou désactive la représentation de l'histogramme.

Paramètre	Renvoi type
{ON 1 OFF 0}. Valeur par défaut : OFF.	0 (OFF) ou 1 (ON)
Voir l' exemple .	

- L'instrument désactive ce paramètre après un changement de la fonction de mesure ou l'exécution de la commande ***RST** ou **SYSTem:PRESet**.

Sous-système CALCulate:SCALE

Ce sous-système contrôle le réglage d'échelle des opérations mathématiques.

Récapitulatif des commandes

CALCulate:SCALE:DB:REFerence

CALCulate:SCALE:DBM:REFerence

CALCulate:SCALE:FUNcTion

CALCulate:SCALE:GAIN

CALCulate:SCALE:OFFSet

CALCulate:SCALE:REFerence

CALCulate:SCALE:REFerence:AUTO

CALCulate:SCALE[:STATe]

CALCulate:SCALE:UNIT

CALCulate:SCALE:UNIT:STATe

CALCulate:SCALE:DB:REFerence {<référence>|MIN|MAX|DEF}
CALCulate:SCALE:DB:REFerence? [{MIN|MAX|DEF}]

Enregistre une valeur relative dans le registre relatif dB du multimètre, qui est utilisé pour la fonction dB dans **CALCulate:SCALE:FUNcTion**. Lorsque la fonction dB est activée, cette valeur est soustraite de chaque mesure de tension une fois la mesure convertie en dBm.

Paramètre	Renvoi type
-200,0 dBm à +200,0 dBm, 0 par défaut, Valeur par défaut : 0.	+3.00000000E+02
Activer le réglage d'échelle dB avec une référence de -10 dB et une résistance de référence de 300 Ω dBm :	
CALC:SCAL:DBM:REF 300	
CALC:SCAL:DB:REF -10.0	
CALC:SCAL:FUNC DB	
CALC:SCAL:STAT ON	

- La saisie d'une valeur de référence entraîne la désactivation de la fonction de sélection de référence automatique (**CALCulate:SCALE:REFerence:AUTO OFF**).
- Le paramètre de valeur relative dB est relatif à la référence dBm définie à l'aide de la commande **CALCulate:SCALE:DBM:REFerence**.
- L'instrument définit la valeur de référence à 0,0 avec la sélection automatique de référence activée après une réinitialisation de la configuration d'usine (***RST**), un pré-réglage de l'instrument (**SYSTem:PRESet**) ou un changement de fonction de mesure.

CALCulate:SCALE:DBM:REFerence {<référence>|MIN|MAX|DEF}
CALCulate:SCALE:DBM:REFerence? [{MIN|MAX|DEF}]

Sélectionne la résistance de référence pour la conversion des mesures de tension en dBm. Cette valeur de référence affecte les fonctions de réglage d'échelle dBm et dB.

Paramètre	Renvoi type
50, 75, 93, 110, 124, 125, 135, 150, 250, 300, 500, 600, 800, 900, 1 000, 1 200 ou 8 000 Ω. Valeur par défaut : 600.	+3.00000000E+02
Activer le réglage d'échelle dBm à l'aide d'une résistance de référence de 300 Ω :	
CALC:SCAL:DBM:REF 300 CALC:SCAL:FUNC DBM CALC:SCAL:STAT ON	

- L'instrument définit la valeur de référence à sa valeur par défaut après une réinitialisation de la configuration d'usine (*RST), un pré-réglage de l'instrument (SYSTEM:PRESet) ou un changement de fonction de mesure.

CALCulate:SCALE:FUNCTion {DB|DBM|PCT|SCALE}
CALCulate:SCALE:FUNCTion?

Sélectionne l'opération qui sera effectuée par la fonction de réglage d'échelle.

Paramètre	Renvoi type
{DB DBM PCT SCALE}	DB, DBM, PCT ou SCALE
Activer la fonction de réglage d'échelle DB par rapport à la mesure suivante effectuée :	
CALC:SCAL:FUNC DB CALC:SCAL:STAT ON	

- Les fonctions PCT et SCALE concernent uniquement les multimètres numériques 34465A et 34470A.
- DB effectue un calcul dB relatif. Le résultat est la différence entre le signal d'entrée et la valeur relative DB enregistrée (CALCulate:SCALE:DB:REFerence), les deux valeurs étant converties en dBm (dB = mesure en dBm – valeur relative en dBm). Pour la fonction dB, la valeur de référence peut être sélectionnée automatiquement à l'aide de la première mesure convertie en dBm comme valeur de référence (voir CALCulate:SCALE:REFerence:AUTO) ou spécifiée par la commande CALCulate:SCALE:DB:REFerence. Le réglage d'échelle dB concerne uniquement les fonctions de mesure en tension alternative et continue.
- DBM effectue un calcul dBm. Le résultat est logarithmique et se base sur un calcul de la puissance fournie à une résistance de référence (CALCulate:SCALE:DBM:REFerence), par rapport à 1 milliwatt. (dBm = $10 \times \log_{10}(\text{mesure}^2 / \text{résistance de référence} / 1 \text{ mW})$). Le réglage d'échelle dBm concerne uniquement les fonctions de mesure en tension alternative et continue.

Référence de programmation SCPI

- PCT effectue un calcul de variation en pourcentage. Le résultat est la variation en pourcentage de la mesure par rapport à la valeur de référence :

$$\text{Résultat} = ((\text{Mesure} - \text{Référence}) / \text{Référence}) * 100$$

Pour la fonction PCT, la valeur de référence peut être sélectionnée automatiquement comme valeur de référence à l'aide de la première mesure (voir **CALCulate:SCALE:REference:AUTO**) ou spécifiée par la commande **CALCulate:SCALE:DB:REference**. Le % de réglage d'échelle s'applique à toutes les fonctions de mesure, à l'exception de Rapport, Continuité et Diode.

- SCALE effectue une opération Mx-B. Le résultat est la mesure multipliée par la valeur du gain M (**CALCulate1:SCALE:GAIN**), moins la valeur du décalage B (**CALCulate1:SCALE:OFFSet**). Le réglage d'échelle Mx-B s'applique à toutes les fonctions de mesure, à l'exception de Rapport, Continuité et Diode.
- Les résultats de la fonction de réglage d'échelle doivent être compris entre -1.0E+24 et -1.0E-24, ou entre +1.0E-24 et 1.0E+24. Les résultats en dehors de ces limites seront remplacés par -9.9E37 (infini négatif), 0 ou 9.9E37 (infini positif).
- Vous devez exécuter la commande **CALCulate:SCALE:FUNCTion** avant la commande **CALCulate:SCALE[:STATe]**, sous peine de provoquer une erreur d'incompatibilité.
- Ce paramètre est défini à sa valeur par défaut après une réinitialisation de la configuration d'usine (***RST**) ou un pré-réglage de l'instrument (**SYSTem:PRESet**).
- Le réglage d'échelle est paramétré sur OFF lorsque vous changez de fonction de mesure (par exemple, lors du passage d'une tension continue à une tension alternative). Vous devez réactiver le réglage d'échelle après avoir changé de fonction de mesure.

CALCulate:SCALE:GAIN {<gain>|MIN|MAX|DEF}

CALCulate:SCALE:GAIN? [{MIN|MAX|DEF}]

Enregistre une valeur de gain **M** pour la fonction de réglage d'échelle dans **CALCulate:SCALE:FUNCTion**.

Paramètre	Renvoi type
-1.0E+15 à -1.0E-15, 0.0, +1.0E-15 à 1.0E+15. Valeur par défaut : 1,0.	+1.00000000E+02
Activez le réglage d'échelle Mx-B avec une référence de 100 et un décalage de 5. CALC:SCAL:FUNC SCAL CALC:SCAL:GAIN 100 CALC:SCAL:OFFS 5 CALC:SCAL:STAT ON	

- Concerne uniquement les modèles 34465A et 34470A.
- L'instrument définit la valeur de gain à 0.0 après une réinitialisation de la configuration d'usine (***RST**) ou un pré-réglage de l'instrument (**SYSTem:PRESet**).

CALCulate:SCALE:OFFSet {<décalage>|MIN|MAX|DEF}

CALCulate:SCALE:OFFSet? [{MIN|MAX|DEF}]

Enregistre une valeur de décalage **M** pour la fonction de réglage d'échelle dans **CALCulate:SCALE:FUNCTion**.

Paramètre	Renvoi type
-1.0E+15 à -1.0E-15, 0.0, +1.0E-15 à 1.0E+15. Valeur par défaut : 0.0.	+5.00000000E+00
Activez le réglage d'échelle Mx-B avec une référence de 100 et un décalage de 5. CALC:SCAL:FUNC SCAL CALC:SCAL:GAIN 100 CALC:SCAL:OFFS 5 CALC:SCAL:STAT ON	

- Concerne uniquement les modèles 34465A et 34470A.
- L'instrument définit la valeur de décalage à 0.0 après une réinitialisation de la configuration d'usine (***RST**) ou un préreglage de l'instrument (**SYSTem:PRESet**).

CALCulate:SCALE:REFerence {<référence>|MIN|MAX|DEF}

CALCulate:SCALE:REFerence? [{MIN|MAX|DEF}]

Enregistre une valeur de référence pour la fonction PCT dans **CALCulate:SCALE:FUNCTion**.

Paramètre	Renvoi type
-1.0E+15 à -1.0E-15, 0.0, +1.0E-15 à 1.0E+15. Valeur par défaut : 0.0.	+3.00000000E+02
Activez le réglage d'échelle avec une référence de 100 V. CALC:SCAL:REF 100 CALC:SCAL:FUNC PCT CALC:SCAL:STAT ON	

- Concerne uniquement les modèles 34465A et 34470A.
- La saisie d'une valeur de référence entraîne la désactivation de la sélection de référence automatique (commande **CALCulate:SCALE:REFerence:AUTO** désactivée).
- L'instrument définit la valeur de référence à 0.0 avec la sélection automatique de référence activée après une réinitialisation de la configuration d'usine (***RST**), un préreglage de l'instrument () ou un changement de fonction de mesure.

CALCulate:SCALE:REFerence:AUTO {ON|1|OFF|0}

CALCulate:SCALE:REFerence:AUTO?

Active/désactive la sélection automatique de référence pour les fonctions de réglage d'échelle dB.

Paramètre	Renvoi type
{ON 1 OFF 0}. Valeur par défaut : ON.	0 (OFF) ou 1 (ON)
Activer la fonction DB avec la sélection automatique de référence et utiliser la première mesure comme valeur de référence : CALC:SCAL:DBM:REF 50 CALC:SCAL:FUNC DB CALC:SCAL:REF:AUTO ON CALC:SCAL:STAT ON READ?	

- **ON** : la première mesure effectuée est utilisée comme référence pour toutes les mesures suivantes, et la sélection automatique de référence est désactivée :
 - Pour la fonction de réglage d'échelle dB, la première mesure est convertie en dBm, et la commande **CALCulate:SCALE:DB:REFerence** est définie sur le résultat.
 - Pour la fonction de réglage d'échelle PCT, la première mesure est convertie en dBm, et la commande **CALCulate:SCALE:DB:REFerence** est définie sur la première mesure.
- **OFF** : la commande **CALCulate:SCALE:DB:REFerence** indique la référence pour le réglage d'échelle DB, alors que la commande **CALCulate:SCALE:REFerence** indique la référence pour le réglage d'échelle PCT.
- L'instrument active la fonction de sélection automatique de référence lorsque la fonction de réglage d'échelle est activée (**CALCulate:SCALE:STATe ON**).
- Ce paramètre est défini sur sa valeur par défaut après une réinitialisation de la configuration d'usine (***RST**), un pré-réglage de l'instrument (**SYSTem:PRESet**) ou un changement de fonction de mesure.
- Vous devez exécuter la commande **CALCulate:SCALE:FUNCTion** avant la commande **CALCulate:SCALE[:STATe]**, sous peine de provoquer une erreur d'incompatibilité.
- Le réglage d'échelle est paramétré sur OFF lorsque vous changez de fonction de mesure (par exemple, lors du passage d'une tension continue à une tension alternative). Vous devez réactiver le réglage d'échelle après avoir changé de fonction de mesure.

CALCulate:SCALE[:STATe] {ON|1|OFF|0}
CALCulate:SCALE[:STATe]?

Active ou désactive la fonction de réglage d'échelle.

Paramètre	Renvoi type
{ON 1 OFF 0}. Valeur par défaut : OFF.	0 (OFF) ou 1 (ON)
Activer la fonction DB avec la sélection automatique de référence et utiliser la première mesure comme valeur de référence :	
CALC:SCAL:DBM:REF 50 CALC:SCAL:FUNC DB CALC:SCAL:REF:AUTO ON CALC:SCAL:STAT ON READ?	

- L'activation de la fonction de réglage d'échelle entraîne également celle de la sélection automatique de la valeur de référence (**CALCulate:SCALE:REFerence:AUTO**).
- Ce paramètre est défini sur sa valeur par défaut après une réinitialisation de la configuration d'usine (***RST**), un pré-réglage de l'instrument (**SYSTem:PRESet**) ou un changement de fonction de mesure.
- Le réglage d'échelle est paramétré sur OFF lorsque vous changez de fonction de mesure (par exemple, lors du passage d'une tension continue à une tension alternative). Vous devez réactiver le réglage d'échelle après avoir changé de fonction de mesure.

CALCulate:SCALE:UNIT <chaîne_entre_guillemets>
CALCulate:SCALE:UNIT?

Vous permet de spécifier un libellé personnalisé de quatre caractères maximum (par exemple, RPM ou °C) pour les mesures mises à l'échelle.

Paramètre	Renvoi type
<chaîne_entre_guillemets> Chaîne ASCII entre guillemets contenant quatre caractères maximum.	« RPM »
Activez le réglage d'échelle avec un gain de 100 et un décalage de 5 et afficher « PSI » avec les mesures sur le panneau avant.	
CALC:SCAL:FUNC SCAL CALC:SCAL:GAIN 100 CALC:SCAL:OFFS 5 CALC:SCAL:UNIT "PSI" CALC:SCAL:UNIT:STAT ON CALC:SCAL:STAT ON	

- Concerne uniquement les modèles 34465A et 34470A.
- <chaîne_entre_guillemets> Vous pouvez utiliser des lettres (A-Z), des chiffres (0-9), un trait de soulignement (_), les signes de ponctuation standard (virgule, e commercial, ...) et certains symboles, notamment le symbole du degré (°).
- Si vous définissez le libellé de mesure à °C, °F ou K, cela n'a aucun effet sur les unités de température définies à l'aide de la commande **UNIT:TEMPerature**.

Référence de programmation SCPI

- La commande **CALCulate:SCALE:UNIT:STATe** détermine si la chaîne d'unités est affichée lorsque la fonction de réglage d'échelle est activée.
- L'instrument rétablit les unités sur la chaîne vide après une réinitialisation de la configuration d'usine (***RST**) ou un préreglage de l'instrument (**SYSTem:PRESet**).

CALCulate:SCALE:UNIT:STATe {OFF|ON}

CALCulate:SCALE:UNIT:STATe?

Active ou désactive l'affichage la chaîne d'unités avec les mesures sur le panneau avant lorsque la fonction de réglage d'échelle est activée.

Paramètre	Renvoi type
{ON 1 OFF 0}. Valeur par défaut : OFF.	0 (OFF) ou 1 (ON)
Activez le réglage d'échelle avec un gain de 100 et un décalage de 5 et afficher « PSI » avec les mesures sur le panneau avant. CALC:SCAL:FUNC SCAL CALC:SCAL:GAIN 100 CALC:SCAL:OFFS 5 CALC:SCAL:UNIT "PSI" CALC:SCAL:UNIT:STAT ON CALC:SCAL:STAT ON	

- Concerne uniquement les modèles 34465A et 34470A.
- La commande **CALCulate:SCALE:UNIT** spécifie la chaîne d'unités à afficher.
- L'instrument désactive l'affichage de la chaîne d'unités après une réinitialisation de la configuration d'usine (***RST**) ou un préreglage de l'instrument (**SYSTem:PRESet**).

Sous-système CALCulate:AVERage

Ce sous-système calcule les statistiques de mesure.

Récapitulatif des commandes

CALCulate:AVERage:ALL?

CALCulate:AVERage:AVERage?

CALCulate:AVERage:CLEar[:IMMEDIATE]

CALCulate:AVERage:COUNT?

CALCulate:AVERage:MAXimum?

CALCulate:AVERage:MINimum?

CALCulate:AVERage:PTPeak?

CALCulate:AVERage:SDEVIation?

CALCulate:AVERage[:STATE]

CALCulate:AVERage:ALL?

CALCulate:AVERage:AVERage?

CALCulate:AVERage:COUNT?

CALCulate:AVERage:MAXimum?

CALCulate:AVERage:MINimum?

CALCulate:AVERage:PTPeak?

CALCulate:AVERage:SDEVIation?

La requête CALCulate:AVERage:ALL? renvoie la moyenne arithmétique (moyenne), l'écart-type, ainsi que les valeurs minimale et maximale de toutes les mesures effectuées depuis le dernier effacement des statistiques. Les statistiques de comptage et de valeurs crête à crête ne sont pas renvoyées par CALCulate:AVERage:ALL?.

Les six autres requêtes répertoriées ci-dessus renvoient des valeurs individuelles.

Paramètre	Renvoi type
(aucun)	(voir ci-dessous)
Renvoyer les statistiques de 100 mesures de fréquence : CONF:FREQ 1.0E3,.001 SAMP:COUN 100 CALC:AVER:STAT ON INIT *WAI CALC:AVER:ALL? Réponse type : +1.00520000E+03,+1.00512000E+03,+1.00527000E+03,+4.13500000E-01	

- Les statistiques sont effacées lorsque la fonction de mesure change ou lorsque l'une des commandes suivantes est exécutée :

CALCulate:AVERage:STATe ON

CALCulate:AVERage:CLEar

INITiate

MEASure:<fonction>?

READ?

*RST

SYSTem:PRESet

- Toutes les valeurs sont renvoyées au format +1.23450000E+01.
- Lorsque la mise à l'échelle dB ou dBm est utilisée, les requêtes CALC:AVER:AVER et CALC:AVER:SDEV renvoient +9.91000000E+37 (et non un nombre).

CALCulate:AVERage:CLEar[:IMMEdiate]

Efface toutes les statistiques calculées : valeur minimale, valeur maximale, valeur moyenne, valeur crête à crête, nombre et écart-type.

Paramètre	Renvoi type
(aucun)	(aucun)
Effacer les données statistiques enregistrées :	
CALC: AVER: CLE	

- Cette commande n’efface pas les mesures de la mémoire de mesures.
- Les statistiques sont effacées lorsque la fonction de mesure change ou lorsque l’une des commandes suivantes est exécutée :

CALCulate:AVERage:STATe ON

CALCulate:AVERage:CLEar

INITiate

MEASure:<fonction>?

READ?

*RST

SYSTem:PRESet

- Pour effacer les statistiques, les limites, les données d’histogramme et les données de mesure, utilisez la commande **CALCulate:CLEar[:IMMEdiate]**.

CALCulate:AVERage[:STATe] {ON|1|OFF|0}

CALCulate:AVERage[:STATe]?

Active ou désactive le calcul des statistiques.

Paramètre	Renvoi type
{ON 1 OFF 0}. Valeur par défaut : OFF.	0 (OFF) ou 1 (ON)
Renvoyer les statistiques de 100 mesures de fréquence :	
CONF:FREQ 1.0E3,.001 SAMP:COUN 100 CALC:AVER:STAT ON INIT *WAI CALC:AVER:ALL?	
Réponse type : +1.00520000E+03,+1.00512000E+03,+1.00527000E+03,+4.13500000E-01	

- Les statistiques sont effacées lorsque la fonction de mesure change ou lorsque l'une des commandes suivantes est exécutée :

CALCulate:AVERage:STATe ON

CALCulate:AVERage:CLEar

INITiate

MEASure:<fonction>?

READ?

*RST

SYSTem:PRESet

- L'instrument désactive ce paramètre après un changement de la fonction de mesure ou l'exécution de la commande *RST ou SYSTem:PRESet.

Sous-système CALCulate:SMOothing

Ce sous-système contrôle le filtre (moyenne flottante) de lissage. Ce sous-système concerne uniquement les modèles 34465A et 34470A.

Récapitulatif des commandes

CALCulate:SMOothing:RESPonse

CALCulate:SMOothing[:STATe]

CALCulate:SMOothing:RESPonse {SLOW|MEDIum|FAST}

CALCulate:SMOothing:RESPonse?

Sélectionne le nombre de mesures moyennées par le filtre (boxcar) à moyenne flottante.

Paramètre	Renvoi type
{SLOW MEDIum FAST} SLOW = 100 mesures, MEDIum = 50 mesures, FAST = 10 mesures. Valeur par défaut : 10 mesures.	SLOW
Activer le filtre à moyenne flottante de 50 points sur 1 000 mesures : CONF:VOLT 10 SAMP:COUN 1000 CALC:SMO:RESP MED CALC:SMO:STAT ON CALC:STAT ON READ?	
Réponse type : +9.99383828200000E+00,+9.99352315400000E+00,... (1 000 mesures)	

- Concerne uniquement les modèles 34465A et 34470A.
- Le filtre (à moyenne flottante) de lissage génère un résultat pour chaque mesure effectuée.
- Le filtre (à moyenne flottante) de lissage est réinitialisé lorsque la fonction de mesure change par la commande **INITiate:IMMEDIATE**, **READ?** ou **MEASure?** ou si une mesure est considérablement supérieure à la moyenne actuelle.
- Une fois le filtre (à moyenne flottante) de lissage réinitialisé, le filtre génère des résultats qui correspondent à la moyenne de toutes les mesures effectuées après la réinitialisation, jusqu'à ce que le nombre nécessaire de mesures soit effectué en fonction de la sélection par la commande **CALCulate:SMOothing:RESPonse**. Une fois les mesures numériques effectuées, les résultats correspondent à la moyenne flottante des 10, 50 ou 100 dernières mesures. Une pondération uniforme est appliquée à toutes les mesures de la moyenne.
- L'instrument définit le délai de réponse sur FAST après une réinitialisation de la configuration d'usine (***RST**) ou après un pré-réglage de l'instrument (**SYSTem:PRESet**).

CALCulate:SMOothing[:STATe] {OFF|ON}
CALCulate:SMOothing[:STATe]?

Active ou désactive un filtre (à moyenne flottante) de lissage sur les mesures. Elle vise à calculer la moyenne des variations mineures observées dans les mesures. Les variations plus importantes provoquent une réinitialisation du filtre.

Paramètre	Renvoi type
{ON 1 OFF 0}. Valeur par défaut : ON.	0 (OFF) ou 1 (ON)
Activer le filtre à moyenne flottante de 50 points sur 1 000 mesures : CONF:VOLT 10 SAMP:COUN 1000 CALC:SMO:RESP MED CALC:SMO:STAT ON CALC:STAT ON READ? Réponse type : +9.99383828200000E+03,+9.99352315400000E+03,... (1 000 mesures)	

- Concerne uniquement les modèles 34465A et 34470A.
- Le sous-système **CALCulate** et les fonctions de calcul individuelles sont désactivés pour les mesures d'horodatage.
- L'instrument désactive le filtre (à moyenne flottante) de lissage après une réinitialisation de la configuration d'usine (***RST**) ou un préréglage de l'instrument (**SYSTem:PRESet**).

CALCulate:TCHart[:STATe] {ON|1|OFF|0}
CALCulate:TCHart[:STATe]?

Active ou désactive les données du diagramme de tendance lors du contrôle de l'instrument à partir de l'interface de commande à distance.

Paramètre	Renvoi type
{OFF ON 0 1}. Valeur par défaut : OFF.	OFF ou ON
Activer les données du diagramme de tendance sur 500 mesures : CALCulate:TCHart:STATe ON CONF:VOLT:DC 10,0.003 SAMP:COUN 500 INIT FETC? Réponse type : +9.99383828200000E+00,+9.99352315400000E+00,... (500 mesures)	

- Vous devez activer ce paramètre (ON) *avant* d'envoyer la commande **INIT** ou **READ?** pour visualiser les données du diagramme de tendance lors du contrôle de l'instrument à partir de l'interface de commande à distance. Si ce paramètre est désactivé ou activé *après* l'envoi de la commande **INIT** ou **READ?**, la visualisation du diagramme de tendance entraîne l'affichage d'un diagramme ne contenant aucune donnée.
- Les données du diagramme de tendance doivent être désactivées (OFF) pour effectuer des mesures à la vitesse maximale (50 kHz).
- Ce paramètre est défini à sa valeur par défaut après une réinitialisation de la configuration d'usine (***RST**) ou un pré réglage de l'instrument (**SYSTem:PRESet**).

Sous-système CALibration

REMARQUE

Lisez la **procédure d'étalonnage** avant d'effectuer un étalonnage. Un étalonnage incorrect peut réduire la précision et la fiabilité de l'instrument.

CALibration:ADC?

CALibration[:ALL]?

CALibration:COUNT?

CALibration:DATE?

CALibration:SECure:CODE

CALibration:SECure:STATe

CALibration:STORe

CALibration:STRing

CALibration:TEMPerature?

CALibration:TIME?

CALibration:VALue

CALibration:ADC?

Effectue un étalonnage de bas niveau du circuit du CAN (convertisseur analogique-numérique).

REMARQUE

Vous devez déverrouiller l'instrument pour l'étalonner ou modifier la chaîne de caractères ou le code de sécurité d'étalonnage.

Paramètre	Renvoi type
(aucun)	0 (réussite) ou 1 (échec)
Étalonner le CAN :	
CAL:ADC?	

- Première étape de la séquence de réétalonnage, cette action doit être effectuée avant de procéder à un étalonnage du décalage.

CALibration[:ALL]?

Effectue un étalonnage à partir de la valeur d'étalonnage selon la fonction et la plage (CALibration:VALue). Un court-circuit doit être appliqué pour les fonctions de mesure de la résistance et de la tension, et les entrées doivent être ouvertes pour les fonctions de mesure de courant.

REMARQUE Vous devez déverrouiller l'instrument pour l'étalonner ou modifier la chaîne de caractères ou le code de sécurité d'étalonnage.

Paramètre	Renvoi type
(aucun)	+0 (réussite) ou +1 (échec)
Effectuer un étalonnage du zéro de la fonction de mesure en tension alternative et renvoyer une indication de réussite/échec :	
CONF:VOLT:AC	
CAL:SEC:STAT OFF,MY_CAL_CODE	
CAL:VAL 0.0	
CAL?	
CAL:STOR	
CAL:SEC:STAT ON	

- Cette requête augmente le nombre d'étalonnages de l'instrument (CALibration:COUNt?) et modifie la version volatile des constantes d'étalonnage. Utilisez la commande CALibration:STORe pour enregistrer ces constantes en mémoire non volatile à la fin de l'étalonnage.

CALibration:COUNt?

Renvoie le nombre de points d'étalonnage. Lisez et annotez le nombre initial à la réception de l'instrument de l'usine.

Paramètre	Renvoi type
(aucun)	+117
Renvoyer le nombre de points d'étalonnage :	
CAL:COUN?	

- Étant donné que cette valeur augmente chaque fois que vous enregistrez les constantes d'étalonnage, un étalonnage complet l'augmente considérablement. Le nombre de points d'étalonnage augmente également chaque fois que vous enregistrez une chaîne d'étalonnage, modifiez le mot de passe d'étalonnage ou remplacez le code de sécurité d'étalonnage.
- Vous pouvez exécuter cette requête, que la sécurité de l'instrument soit ou non verrouillée.
- Ce paramètre est non volatile ; il n'est pas altéré par une remise sous tension ou l'exécution de la commande *RST ou SYSTem:PRESet.

Voir également

SYSTem:SECurity:COUNt?

CALibration:DATE?

Renvoie la date du dernier étalonnage au format *aaaa,mm,jj*.

Paramètre	Renvoi type
(aucun)	2014,4,26
Renvoyer la date d'étalonnage :	
CAL:DATE?	

- Vous pouvez exécuter cette requête, que la sécurité de l'instrument soit ou non verrouillée.
- La date est basée sur l'horloge en temps réel de l'instrument. Réglez la date de l'horloge en temps réel de l'instrument à l'aide des commandes **SYSTem:DATE** et **SYSTem:TIME**.
- Ce paramètre est non volatile ; il n'est pas altéré par une remise sous tension ou l'exécution de la commande ***RST** ou **SYSTem:PRESet**.

Voir également

SYSTem:DATE

SYSTem:TIME

CALibration:SECure:CODE <nouveau_code>

Configure le code de sécurité afin d'interdire les étalonnages non autorisés.

REMARQUE Vous devez déverrouiller l'instrument pour l'étalonner ou modifier la chaîne de caractères ou le code de sécurité d'étalonnage.

Paramètre	Renvoi type
Chaîne de caractères sans guillemets contenant jusqu'à 12 caractères Doit commencer par une lettre (A-Z) Peut contenir des lettres, des chiffres (0 à 9) et des traits de soulignement	(aucun)
Définir le nouveau code de sécurité :	
CAL:SEC:STAT OFF,OLD_CAL_CODE CAL:SEC:CODE TST_DUT165 CAL:SEC:STAT ON	

- Pour modifier le code : déverrouillez la mémoire d'étalonnage avec l'ancien code, puis définissez le nouveau code.
- En cas d'oubli du code de sécurité, reportez-vous à la section **Remplacement du code de sécurité**.
- À la livraison de l'usine, l'instrument est verrouillé par le code de sécurité défini sur **AT3446XA**.
- Ce paramètre est non volatile ; il n'est pas altéré par une remise sous tension ou l'exécution de la commande ***RST** ou **SYSTem:PRESet**.

CALibration:SECure:STATe {ON|1|OFF|0}[, <code>]

CALibration:SECure:STATe?

Active ou désactive la sécurité de l'instrument pour l'étalonnage.

REMARQUE Vous devez déverrouiller l'instrument pour l'étalonner ou modifier la chaîne de caractères ou le code de sécurité d'étalonnage.

Paramètre	Renvoi type
{ON 1 OFF 0}. Valeur par défaut : ON.	0 (OFF) ou 1 (ON)
Déverrouiller la sécurité d'étalonnage :	
CAL:SEC:STAT OFF,MY_CODE_272	
Verrouiller la sécurité d'étalonnage :	
CAL:SEC:STAT ON	

- Le <code> est facultatif pour sécuriser l'instrument ; néanmoins, il doit être correct s'il est fourni.
- À la livraison de l'usine, l'instrument est verrouillé par le code de sécurité défini sur **AT3446XA**.
- L'étalonnage sur le panneau avant ou à partir de l'interface de commande à distance utilise le même code.
- Ce paramètre est non volatile ; il n'est pas altéré par une remise sous tension ou l'exécution de la commande ***RST** ou **SYSTem:PRESet**.

CALibration:STORE

Prélève les constantes d'étalonnage en mémoire volatile (**CALibration:ALL?**) et les place en mémoire non volatile, dans laquelle elles ne seront pas modifiées par une remise sous tension ou l'exécution des commandes ***RST** ou **SYSTem:PRESet**. Effectuez cette opération à la fin de l'étalonnage pour éviter de perdre les modifications.

REMARQUE Vous devez déverrouiller l'instrument pour l'étalonner ou modifier la chaîne de caractères ou le code de sécurité d'étalonnage.

Paramètre	Renvoi type
(aucun)	(aucun)
Enregistrer les constantes d'étalonnage en mémoire non volatile :	
CAL:STOR	

CALibration:STRing "<chaîne>"**CALibration:STRing?**

Enregistre un message dans la mémoire d'étalonnage. Les messages courants incluent la dernière date d'étalonnage, la date d'échéance de l'étalonnage ou les coordonnées du service d'étalonnage. Vous pouvez exécuter cette requête, que la sécurité de l'instrument soit ou non verrouillée.

REMARQUE Vous devez déverrouiller l'instrument pour l'étalonner ou modifier la chaîne de caractères ou le code de sécurité d'étalonnage.

Paramètre	Renvoi type
Chaîne de caractères entre guillemets contenant jusqu'à 40 caractères Peut contenir des lettres, des chiffres, des espaces et d'autres caractères courants.	"FOR CAL HELP, CALL JOE AT EXT 1234" (Si aucune chaîne n'est stockée, renvoie "")
CAL:STR "FOR CAL HELP, CALL JOE AT EXT 1234"	

- Cette chaîne peut être uniquement enregistrée depuis l'interface de commande à distance. Toutefois, vous pouvez lire le message à partir du panneau avant ou de l'interface de commande à distance.
- L'enregistrement d'un message d'étalonnage entraîne le remplacement du message précédent.
- Ce paramètre est non volatile ; il n'est pas altéré par une remise sous tension ou l'exécution de la commande ***RST** ou **SYSTem:PRESet**.

CALibration:TEMPerature?

Renvoie la température du dernier étalonnage en °C.

Paramètre	Renvoi type
(aucun)	+2.42850208E+001
Renvoyer la température d'étalonnage :	
CAL:TEMP?	

- Vous pouvez exécuter cette requête, que la sécurité de l'instrument soit ou non verrouillée.
- Ce paramètre est non volatile ; il n'est pas altéré par une remise sous tension ou l'exécution de la commande ***RST** ou **SYSTem:PRESet**.

CALibration:TIME?

Renvoie l'heure du dernier étalonnage au format *hh,mm,ss.sss*.

Paramètre	Renvoi type
(aucun)	20,15,30,000
Renvoyer l'heure d'étalonnage :	
CAL:TIME?	

- Vous pouvez exécuter cette requête, que la sécurité de l'instrument soit ou non verrouillée.
- La date est basée sur l'horloge en temps réel de l'instrument. Réglez la date de l'horloge en temps réel de l'instrument à l'aide des commandes **SYSTem:DATE** et **SYSTem:TIME**.
- Ce paramètre est non volatile ; il n'est pas altéré par une remise sous tension ou l'exécution de la commande ***RST** ou **SYSTem:PRESet**.

Voir également

SYSTem:TIME

SYSTem:DATE

CALibration:VALue <valeur>

CALibration:VALue?

Spécifie la valeur du signal d'étalonnage appliqué.

REMARQUE Vous devez déverrouiller l'instrument pour l'étalonner ou modifier la chaîne de caractères ou le code de sécurité d'étalonnage.

Paramètre	Renvoi type
Numérique, 0,0 par défaut	+2.37000000E-02
Spécifier la valeur d'étalonnage 0.0237 :	
CAL:VAL 2.37E-2	

- Ce paramètre est défini à sa valeur par défaut après une réinitialisation de la configuration d'usine (***RST**) ou un préréglage de l'instrument (**SYSTem:PRESet**).

Sous-système CONFigure

Les commandes CONFigure constituent la manière la plus concise de configurer les mesures. Comme les requêtes **MEASure?**, ces commandes utilisent les valeurs de configuration de mesures par défaut. Cependant, elles ne démarrent pas automatiquement les mesures. Ainsi, vous pouvez modifier les attributs de mesure avant d'initier la mesure.

REMARQUE Utilisez la commande **INITiate** ou **READ?** pour initier les mesures.

Récapitulatif des commandes

CONFigure?

CONFigure:CAPacitance

CONFigure:CONTInuity

CONFigure:CURREnt:{AC|DC}

CONFigure:DIODE

CONFigure:{FREQuency|PERiod}

CONFigure:{RESistance|FRESistance}

CONFigure:TEMPerature

CONFigure[:VOLTage]:{AC|DC}

CONFigure[:VOLTage][:DC]:RATio

Paramètres par défaut de la commande CONFigure

Les commandes CONFigure sélectionnent la fonction, la plage et la résolution dans une commande unique. Spécifiez la *<résolution>* dans les unités de mesure (V, A, Hz, Ω , etc.). Tous les autres paramètres sont définis à leurs valeurs par défaut (ci-dessous).

Mesure Paramètre	Paramètre par défaut
Filtre d'entrée secteur (bande passante)	20 Hz (filtre moyen)
Réglage automatique du zéro	Désactivé si le paramètre de résolution produit un nombre de NPLC < 1 Activé si le paramètre de résolution produit un nombre de NPLC \geq 1
Plage	AUTO (notamment la plage de tension pour les mesures de fréquence et de période)
Échantillons par déclenchement	1 échantillon
Nombre de déclenchements	1 déclenchement
Retard de déclenchement	Retard automatique
Source de déclenchement	Immédiate
Pente de déclenchement	NEGative
Fonctions mathématiques	Désactivées. Les autres paramètres ne changent pas.
État Null par fonction	Désactivé

Utilisation de la commande CONFigure

L'exemple suivant utilise les commandes CONFigure et **READ?** pour effectuer une mesure déclenchée en externe. La commande CONFigure configure les mesures en tension continue, mais ne place pas l'instrument à l'état « en attente de déclenchement ».

La requête **READ?** place l'instrument à l'état « en attente de déclenchement », initie une mesure lorsque l'entrée **Ext Trig** du panneau arrière est pulsée (impulsion basse par défaut), enregistre la mesure dans la mémoire de mesures et transfère la mesure vers le tampon de sortie de l'instrument. La plage par défaut (commutation automatique de plage) et la résolution (10 PLC) sont utilisées pour la mesure.

```
CONF:VOLT:DC
TRIG:SOUR EXT
READ?
```

Réponse type : +4.27150000E+00

L'exemple suivant est identique au précédent, mais utilise les commandes **INITiate** et **FETCh?** à la place de la commande **READ?**. La commande **INITiate** place l'instrument à l'état « en attente de déclenchement », déclenche une mesure lorsque l'entrée **Ext Trig** du panneau arrière est pulsée (impulsion basse par défaut) et envoie la mesure à la mémoire de mesures. La requête **FETCh?** transfère la mesure de la mémoire de mesures vers le tampon de sortie de l'instrument.

```
CONF:VOLT:DC
TRIG:SOUR EXT
INIT
FETC?
```

Réponse type : +5.34250000E+00

La procédure d'enregistrement de mesures dans la mémoire de mesures à l'aide de la commande **INITiate** est plus rapide que celle consistant à envoyer des mesures au tampon de sortie de l'instrument avec la commande **READ?** (à condition que vous n'exécutiez pas la commande **FETCh?** avant la fin de l'opération). La commande **INITiate** est également une commande « superposée ». Autrement dit, après avoir exécuté la commande **INITiate**, vous pouvez envoyer d'autres commandes qui n'affectent pas les mesures. Cela vous permet de vérifier la disponibilité des données avant d'effectuer une tentative de lecture qui pourrait autrement expirer. Notez que la requête **FETCh?** attend que toutes les mesures soient terminées pour terminer. Vous pouvez enregistrer jusqu'à 1 000 mesures dans la mémoire de lecture du modèle 34460A, 10 000 mesures dans celle du modèle 34461A, 50 000 mesures sur le modèle 34465A/70A (sans l'option MEM) ou 2 000 000 mesures sur le modèle 34465A/70A (avec l'option MEM).

L'exemple suivant illustre la configuration de l'instrument pour des mesures de résistance en 2 fils, le déclenchement de l'instrument pour effectuer une mesure à l'aide de la commande **INITiate** et la sauvegarde de la mesure dans la mémoire de mesures. La plage de 10 k Ω est sélectionnée avec une résolution de 100 Ω .

```
CONF:RES 10000,100
INIT
FETC?
```

Réponse type : +5.95850000E+03

CONFigure?

Renvoie une chaîne de caractères entre guillemets indiquant la fonction, la plage et la résolution actuelles. La forme abrégée du nom de la fonction (CURR:AC, FREQ) est toujours renvoyée.

Paramètre	Renvoi type
(aucun)	"VOLT +1.00000000E+01,+3.00000000E-06"
Renvoyer la fonction, la plage et la résolution actuelles :	
CONF?	

CONFigure:CAPacitance [{<plage>|AUTO|MIN|MAX|DEF} [, {<résolution>|MIN|MAX|DEF}]]

Définit tous les paramètres de mesure et de déclenchement à leurs **valeurs par défaut** pour les mesures de température. Indique également la plage.

Paramètre	Renvoi type
<plage> : {1 nF 10 nF 100 nF 1 µF 10 µF 100 µF}. Valeur par défaut : AUTO.	(aucun)
<résolution> : facultative et ignorée ; fixe à 4½ chiffres.	
Configurez les mesures de capacité avec la plage de 1 µF. Effectuez et lisez deux mesures : CONF:CAP SAMP:COUN 2 READ? Réponse type : +3.01574316E-10,+3.01659030E-10	

- Vous pouvez laisser la fonction de commutation automatique de plage sélectionner la plage de mesure ou bien sélectionner manuellement une plage fixe. La commutation automatique de plage sélectionne facilement la plage pour chaque mesure en fonction du signal d'entrée. Pour des mesures ultra rapides, utilisez la commutation manuelle (la commutation automatique peut nécessiter plus de temps pour la sélection de la plage).
- La commutation automatique de plage (AUTO ou DEFault) génère une erreur si vous spécifiez une <résolution> car l'instrument ne peut pas résoudre avec précision le temps d'intégration (notamment si l'entrée change continuellement). Si votre application requiert une commutation automatique de plage, spécifiez DEFault pour la <résolution> ou omettez complètement la <résolution>.
- La commutation automatique de plage descend d'une plage à moins de 10 % de la plage et augmente d'une plage à plus de 120 % de la plage. Pour les mesures de capacité uniquement, lorsque la fonction de commutation automatique de plage est désactivée, l'instrument ne signale pas de surcharge pour les lectures supérieures à 120 % de la plage. Une surcharge se produit uniquement une fois le délai de l'algorithme dépassé car la capacité appliquée est trop élevée pour l'algorithme à mesurer. Si vous appliquez une tension continue ou un court-circuit aux bornes d'entrée en mode de mesure de capacité, l'instrument rapporte une surcharge.
- Si le signal d'entrée est supérieur au signal pouvant être mesuré dans la plage manuelle spécifiée, l'instrument affiche l'indication *Overload* (Surcharge) sur le panneau avant et renvoie « 9.9E37 » depuis l'interface de commande à distance.
- Utilisez la commande **READ?** ou **INITiate** pour lancer la mesure.

CONFigure:CONTInuity

Définit tous les paramètres de mesure et de déclenchement à leurs **valeurs par défaut** pour les mesures de continuité.

Paramètre	Renvoi type
(aucun)	+1.32130000E-02
Configurez l'instrument pour des mesures de continuité. Effectuez ensuite une mesure à l'aide d'un déclenchement externe avec pente positive (front montant) et lisez la mesure : CONF:CONT TRIG:SOUR EXT;SLOP POS READ?	

- La plage et la résolution sont fixes à 1 k Ω pour les tests de continuité (mesure de résistance en 2 fils).
- L'instrument émet un signal sonore (si l'avertisseur sonore est activé) pour chaque mesure inférieure ou égale au seuil de continuité ($\leq 10 \Omega$), et la mesure de résistance réelle s'affiche à l'écran.
- Entre 10 Ω et 1,2 k Ω , l'instrument affiche la mesure de résistance réelle sans aucun signal sonore. Au-delà de 1,2 k Ω , l'instrument affiche le message « OPEN » sans émettre de signal sonore.
- Les requêtes **FETCh?**, **READ?** et **MEASure:CONTInuity?** renvoient la résistance mesurée, quelle que soit sa valeur.
- Utilisez la commande **READ?** ou **INITiate** pour lancer la mesure.

CONFigure:CURRent:{AC|DC} [{<plage>|AUTO|MIN|MAX|DEF} [, {<résolution>|MIN|MAX|DEF}]]

Définit tous les paramètres de mesure et de déclenchement à leurs **valeurs par défaut** pour les mesures en courant alternatif et continu. Indique également la plage et la résolution.

Paramètre	Renvoi type
<p><plage> : {100 µA 1 mA 10 mA 100 mA 1 A 3 A 10 A}. Valeur par défaut : AUTO (commutation automatique de plage).</p> <p><résolution> (courant alternatif) : facultative et ignorée ; fixe à 6½ chiffres.</p> <p><résolution> (courant continu) : Voir Tableau de résolution ou Plage, résolution et NPLC. La valeur par défaut est équivalente à 10 PLC. Spécifiez la <résolution> dans les unités de mesure (V, A, Hz, Ω, etc.).</p>	(aucun)
<p>Configurez les mesures en courant alternatif avec la plage de 1 A. Effectuez et lisez deux mesures :</p> <pre>CONF:CURR:AC 1 SAMP:COUN 2 READ?</pre> <p>Réponse type : +8.54530000E-01,+8.54520000E-01</p> <p>Configurez les mesures en courant continu avec la plage de 1 A et une résolution de 1 mA. Effectuez ensuite une mesure à l'aide d'un déclenchement externe avec pente positive (front montant) et lisez la mesure :</p> <pre>CONF:CURR:DC 1,0.001 TRIG:SOUR EXT;SLOP POS INIT FETC?</pre> <p>Réponse type : +4.27150000E-01</p>	

- La sélection de la plage de 10 A entraîne automatiquement la définition du paramètre [SENSe:]CURRent:{AC|DC}:TERMinals sur 10 A, et la configuration de la plage sur une valeur inférieure à 3 A et la définition du paramètre [SENSe:]CURRent:{AC|DC}:TERMinals sur 3 A.
- Pour les modèles 34461A/65A/70A, lorsque le commutateur avant/arrière est défini sur Front (Avant), la définition de la plage sur MAX entraîne la sélection de la plage 10 A et des bornes 10 A. Lorsque le commutateur avant/arrière est défini sur Rear (Arrière), la définition de la plage sur MAX entraîne la sélection de la plage 3 A et des bornes 3 A.
- Vous pouvez laisser la fonction de commutation automatique de plage sélectionner la plage de mesure ou bien sélectionner manuellement une plage fixe. La commutation automatique de plage sélectionne facilement la plage pour chaque mesure en fonction du signal d'entrée. Pour des mesures ultra rapides, utilisez la commutation manuelle (la commutation automatique peut nécessiter plus de temps pour la sélection de la plage).
- La commutation automatique de plage (AUTO ou DEFault) génère une erreur si vous spécifiez une <résolution> car l'instrument ne peut pas résoudre avec précision le temps d'intégration (notamment si l'entrée change continuellement). Si votre application requiert une commutation automatique de plage, spécifiez DEFault pour la <résolution> ou omettez complètement la <résolution>.
- La commutation automatique de plage descend d'une plage à moins de 10 % de la plage et augmente d'une plage à plus de 120 % de la plage.

- Si le signal d'entrée est supérieur au signal pouvant être mesuré dans la plage manuelle spécifiée, l'instrument affiche l'indication *Overload* (Surcharge) sur le panneau avant et renvoie « 9.9E37 » depuis l'interface de commande à distance.
- Pour contrôler la vitesse des mesures en courant alternatif, modifiez le retard de déclenchement ou la bande passante du filtre de courant alternatif.
- Utilisez la commande **READ?** ou **INITiate** pour lancer la mesure.

Voir également

CONFigure?

MEASure:CURRent:{AC|DC}?

[SENSe:]CURRent:AC:BANDwidth

CONFigure:DIODe

Définit tous les paramètres de mesure et de déclenchement à leurs **valeurs par défaut** pour les tests de diodes.

Paramètre	Renvoi type
(aucun)	(aucun)
Configurer, effectuer et lire une mesure de diode par défaut :	
CONF:DIOD	
READ?	
Réponse type : +1.32130000E-01	

- La plage et la résolution sont *fixes* pour les tests de diode ; la plage est de 1 Vcc (avec une sortie de source de courant de 1 mA).
- La tension est affichée sur le panneau avant si elle est comprise entre 0 et 5,05 V. L'instrument émet un signal sonore lorsque le signal passe dans la plage comprise entre 0,3 et 0,8 V (sauf si l'avertisseur sonore est désactivé). Si le signal dépasse 5,05 V, le panneau avant affiche « OPEN » et la valeur renvoyée par SCPI est 9.9E37.
- Les requêtes **FETCh?**, **READ?** et **MEASure:DIODe?** renvoient la tension mesurée, quelle que soit sa valeur.
- Utilisez la commande **READ?** ou **INITiate** pour lancer la mesure.

CONFigure:{FREQuency|PERiod} [{<plage>|MIN|MAX|DEF} [, {<résolution>|MIN|MAX|DEF}]]

Définit tous les paramètres de mesure et de déclenchement à leurs **valeurs par défaut** pour les mesures de fréquence ou de période. Indique également la plage et la résolution de *fréquence* ou de *période*.

Paramètre	Renvoi type
<plage> : 3 Hz à 300 kHz. Valeur par défaut : 20 Hz. (FREQuency)	(aucun)
<plage> : 3,33 µs à 333,33 ms. Valeur par défaut : 50 ms (PERiod).	
<résolution> : Voir le tableau ci-dessous. Spécifiez la <résolution> dans les unités de mesure (V, A, Hz, Ω, etc.).	
Configurez les mesures de fréquence avec l'ouverture par défaut et le filtre CA (rapide) de 200 Hz. Puis, effectuez et lisez une mesure : CONF:FREQ FREQ:RANG:LOW 200 READ? Réponse type : +1.32130000E+03	

- L'ouverture de 1 mS concerne uniquement les modèles 34465A et 34470A.
- Le paramètre <plage> de la fréquence ou de la période est uniquement nécessaire pour spécifier le paramètre de résolution de mesure. Il n'est pas nécessaire d'envoyer une nouvelle commande pour chaque nouvelle fréquence ou période à mesurer. Les paramètres <plage> et <résolution> affectent l'ouverture (temps de porte) comme suit :

Résolution (34460A/61A)	Résolution (34465A/70A)	Ouverture
Sans objet	100 ppm × <plage> (MAXimum)	1 ms
100 ppm × <plage> (MAXimum)	10 ppm × <plage> (DEFault)	10 ms
10 ppm × <plage> (DEFault)	1 ppm × <plage>	100 ms
1 ppm × <plage> (MINimum)	0,1 ppm × <plage> (MINimum)	1 s

- Le signal d'entrée pour les mesures de fréquence ou de période inclut un composant de *tension alternative*. Utilisez la commande `[SENSe:]{FREQuency|PERiod}:VOLTage:RANGe:AUTO` pour désactiver ou activer la commutation automatique de plage ou la commande `CONFigure:{FREQuency|PERiod}` pour sélectionner la commutation automatique de plage par défaut. Utilisez la commande `[SENSe:]{FREQuency|PERiod}:VOLTage:RANGe` pour sélectionner une plage de tension fixe pour les mesures de fréquence et de période.
- Si la tension d'entrée est trop élevée pour la plage de tension sélectionnée (commutation manuelle), l'instrument affiche l'indication Overload (Surcharge) sur le panneau avant et renvoie « 9.9E37 » depuis l'interface de commande à distance. La commutation automatique de plage peut être activée pour la tension d'entrée.
- Utilisez la commande `READ?` ou `INITiate` pour lancer la mesure.

Voir également

`CONFigure?`

`MEASure:{FREQuency|PERiod}?`

CONFigure:{RESistance|FRESistance} [{<plage>|AUTO|MIN|MAX|DEF} [, {<résolution>|MIN|MAX|DEF}]]

Définit tous les paramètres de mesure et de déclenchement à leurs **valeurs par défaut** pour les mesures de résistance en 4 fils (FRESistance) ou en 2 fils (RESistance). Indique également la plage et la résolution.

Paramètre	Renvoi type
<plage> : 100 Ω, 1 kΩ, 10 kΩ, 100 kΩ, 1 MΩ, 10 MΩ, 100 MΩ, 1 GΩ, AUTO ou DEFault. Valeur par défaut : AUTO.	+8.54530000E+01
<résolution> : Voir Tableau de résolution ou Plage, résolution et NPLC . La valeur par défaut est équivalente à 10 PLC. Spécifiez la <résolution> dans les unités de mesure (V, A, Hz, Ω, etc.).	
Configurez les mesures de résistance en 4 fils avec la plage de 100 Ω et la résolution par défaut. Effectuez et lisez deux mesures :	
CONF:FRES 100 SAMP:COUN 2 READ?	
Réponse type : +8.54530000E+01,+8.54520000E+01	

- La plage de 1 GΩ concerne uniquement les modèles 34465A et 34470A.
- Vous pouvez laisser la fonction de commutation automatique de plage sélectionner la plage de mesure ou bien sélectionner manuellement une plage fixe. La commutation automatique de plage sélectionne facilement la plage pour chaque mesure en fonction du signal d'entrée. Pour des mesures ultra rapides, utilisez la commutation manuelle (la commutation automatique peut nécessiter plus de temps pour la sélection de la plage).
- La commutation automatique de plage (AUTO ou DEFault) génère une erreur si vous spécifiez une <résolution> car l'instrument ne peut pas résoudre avec précision le temps d'intégration (notamment si l'entrée change continuellement). Si votre application requiert une commutation automatique de plage, spécifiez DEFault pour la <résolution> ou omettez complètement la <résolution>.
- La commutation automatique de plage descend d'une plage à moins de 10 % de la plage et augmente d'une plage à plus de 120 % de la plage.
- Si le signal d'entrée est supérieur au signal pouvant être mesuré dans la plage manuelle spécifiée, l'instrument affiche l'indication *Overload* (Surcharge) sur le panneau avant et renvoie « 9.9E37 » depuis l'interface de commande à distance.
- Utilisez la commande **READ?** ou **INITiate** pour lancer la mesure.

Voir également

CONFigure?

MEASure:{RESistance|FRESistance}?

CONF:TEMPerature [{FRTD|RTD|FTHermistor|THERmistor|TCouple|DEFault} [, {<type>|DEFault} [,1 [, {<résolution>|MIN|MAX|DEF}]]]]

Définit tous les paramètres de mesure et de déclenchement à leurs **valeurs par défaut** pour les mesures de température. Indique également le transducteur et la résolution de la mesure.

Paramètre	Renvoi type
<type_sonde> : {FRTD RTD FTHermistor THERmistor TCouple}. Valeur par défaut : FRTD.	+2.12320000E+01
<type> : 85 (seule valeur possible pour RTD/FRTD) ou 5 000 (seule valeur possible pour THERmistor/FTHermistor) ou E, J, K, N, R, T (TCouple).	
<résolution> : Voir Tableau de résolution ou Plage, résolution et NPLC . La valeur par défaut est équivalente à 10 PLC.	
Configurez une mesure de RTD en 4 fils. Effectuez ensuite une mesure à l'aide d'un déclenchement externe avec pente positive (front montant) et lisez la mesure : CONF:TEMP FRTD,85 TRIG:SOUR EXT;SLOP POS READ?	

- Les mesures par thermocouples (TC) concernent uniquement les modèles 34465A et 34470A.
- Pour les mesures de température, l'instrument sélectionne la plage en interne ; vous ne pouvez pas sélectionner la plage à utiliser.
- Le paramètre <résolution> détermine uniquement le temps d'intégration. Il n'indique pas la résolution de la mesure de température. Ce paramètre est facultatif. Cependant, si vous indiquez le paramètre <résolution>, vous devez également spécifier « 1 » comme paramètre de plage implicite. Par exemple : CONF:TEMP RTD,85,1,0.000001 sélectionne le temps d'intégration de 10 PLC sur le modèle 34461A.
- Pour modifier les unités de température, utilisez la commande **UNIT:TEMPerature**.
- Pour les mesures de thermistance et de RTD, l'instrument sélectionne automatiquement la plage correcte en fonction de la mesure de résistance du capteur. Pour les mesures par thermocouples, la plage de 100 mV est sélectionnée.
- Pour les mesures par thermocouples, la référence interne est sélectionnée. Voir **SENSe:TEMPerature:TCouple:RJUNction:TYPE**.
- Si le signal d'entrée est supérieur au signal pouvant être mesuré dans la plage manuelle spécifiée, l'instrument affiche l'indication *Overload* (Surcharge) sur le panneau avant et renvoie « 9.9E37 » depuis l'interface de commande à distance.
- Utilisez la commande **READ?** ou **INITiate** pour lancer la mesure.

CONFigure[:VOLTage]:{AC|DC} [{<plage>|AUTO|MIN|MAX|DEF} [, {<résolution>|MIN|MAX|DEF}]]

Définit tous les paramètres de mesure et de déclenchement à leurs **valeurs par défaut** pour les mesures en tension alternative ou continue. Indique également la plage et la résolution.

AVERTISSEMENT

Le paramètre de plage maximal (MAX) est de 1 000 V. Cependant, la LIMITE DE SÉCURITÉ sur les bornes d'entrée HI/LO avant et arrière est de 750 Vca (eff.). La tension efficace vraie dépend du signal. Une onde sinusoïdale est limitée à 750 Vca (eff.), mais une onde carrée de 1 000 V crête est sûre. La connexion à l'alimentation secteur est en outre limitée à la catégorie de mesure II (300 V). Pour de plus amples informations sur les fonctions de sécurité et l'utilisation sans danger de cet instrument, reportez-vous à la section **Informations de sécurité et réglementaires**.

Paramètre	Renvoi type
<plage> : {100 mV 1 V 10 V 100 V 1 000 V}. Valeur par défaut : AUTO (commutation automatique de plage).	(aucun)
<résolution> (courant alternatif) : facultative et ignorée ; fixe à 6½ chiffres.	
<résolution> (courant continu) : Voir Tableau de résolution ou Plage, résolution et NPLC . La valeur par défaut est équivalente à 10 PLC. Spécifiez la <résolution> dans les unités de mesure (V, A, Hz, Ω, etc.).	
Configurez les mesures en tension alternative avec la plage de 100 V. Effectuez et lisez deux mesures : CONF:VOLT:AC 100 SAMP:COUN 2 READ? Réponse type : +8.54530000E+01,+8.54520000E+01 Configurez les mesures en tension continue avec la plage de 10 V et la résolution de 1 mV. Effectuez ensuite une mesure à l'aide d'un déclenchement externe avec pente positive (front montant) et lisez la mesure : CONF:VOLT:DC 10,0.001 TRIG:SOUR EXT;SLOP POS INIT FETC? Réponse type : +4.27150000E+00	

- Vous pouvez laisser la fonction de commutation automatique de plage sélectionner la plage de mesure ou bien sélectionner manuellement une plage fixe. La commutation automatique de plage sélectionne facilement la plage pour chaque mesure en fonction du signal d'entrée. Pour des mesures ultra rapides, utilisez la commutation manuelle (la commutation automatique peut nécessiter plus de temps pour la sélection de la plage).
- La commutation automatique de plage (AUTO ou DEFault) génère une erreur si vous spécifiez une <résolution> car l'instrument ne peut pas résoudre avec précision le temps d'intégration (notamment si l'entrée change continuellement). Si votre application requiert une commutation automatique de plage, spécifiez DEFault pour la <résolution> ou omettez complètement la <résolution>.
- La commutation automatique de plage descend d'une plage à moins de 10 % de la plage et augmente d'une plage à plus de 120 % de la plage.

- Si le signal d'entrée est supérieur au signal pouvant être mesuré dans la plage manuelle spécifiée, l'instrument affiche l'indication *Overload* (Surcharge) sur le panneau avant et renvoie « 9.9E37 » depuis l'interface de commande à distance.
- Pour contrôler la vitesse des mesures en courant alternatif, modifiez le retard de déclenchement ou la bande passante du filtre de courant alternatif.
- Utilisez la commande **READ?** ou **INITiate** pour lancer la mesure.

Voir également

CONFigure?

MEASure[:VOLTage]:{AC|DC}?

[SENSe:]CURRent:AC:BANDwidth

CONFigure[:VOLTage][:DC]:RATio [{<plage>|AUTO|MIN|MAX|DEF} [, {<résolution>|MIN|MAX|DEF}]]

Définit tous les paramètres de mesure et de déclenchement à leurs **valeurs par défaut** pour les mesures en tension continue et du rapport de tension continue. Indique également la plage et la résolution.

Pour calculer un rapport, l'instrument mesure une tension de référence continue appliquée à la borne de *mesure* et la tension de signal continue appliquée aux bornes d'*entrée*. Il utilise ensuite la formule suivante :

$$\text{Rapport} = \text{tension de signal continue} / \text{tension de référence continue}$$

Paramètre	Renvoi type
<plage> : {100 mV 1 V 10 V 100 V 1 000 V}. Valeur par défaut : AUTO (commutation automatique de plage).	(aucun)
<résolution> : Voir Tableau de résolution ou Plage, résolution et NPLC . La valeur par défaut est équivalente à 10 PLC.	
<p>Configurez l'instrument pour des mesures du rapport de tension avec la plage de 100 V et une résolution de 1 mV. Effectuez ensuite une mesure à l'aide d'un déclenchement externe avec pente positive (front montant) et lisez la mesure :</p> <pre>CONF:VOLT:DC:RAT 100,0.001 TRIG:SOUR EXT;SLOP POS INIT FETC?</pre> <p>Réponse type : +4.27150000E+00</p>	

- Les bornes de *mesure* incluent une entrée mesurable maximale de ± 12 Vcc. La commutation automatique de plage est automatiquement sélectionnée pour les mesures de tension de référence sur les bornes de *mesure*.
- Les bornes d'*entrée* LO et de *mesure* LO doivent avoir une référence commune et leur différence de tension ne doit pas être supérieure à ± 2 V.
- La plage de mesure spécifiée s'applique uniquement au signal connecté aux bornes d'*entrée*. Le signal sur les bornes d'*entrée* peut être n'importe quelle tension continue jusqu'à 1 000 V.
- Pour les bornes d'*entrée*, vous pouvez laisser l'instrument sélectionner la plage de mesure à l'aide de la fonction de commutation automatique ou bien sélectionner une plage fixe à l'aide de la fonction de *commutation manuelle*. La fonction de commutation automatique détermine la plage à utiliser pour chaque mesure en fonction du signal d'entrée. Pour des mesures plus rapides, utilisez la fonction de commutation manuelle sur chaque mesure (un temps supplémentaire est nécessaire pour que la fonction de commutation automatique sélectionne une plage).
- La commutation automatique de plage (AUTO ou DEFault) génère une erreur si vous spécifiez une <résolution> car l'instrument ne peut pas résoudre avec précision le temps d'intégration (notamment si l'entrée change continuellement). Si votre application requiert une commutation automatique de plage, spécifiez DEFault pour la <résolution> ou omettez complètement la <résolution>.
- La commutation automatique de plage descend d'une plage à moins de 10 % de la plage et augmente d'une plage à plus de 120 % de la plage.

- Si le signal d'entrée est supérieur au signal pouvant être mesuré dans la plage manuelle spécifiée, l'instrument affiche l'indication *Overload* (Surcharge) sur le panneau avant et renvoie « 9.9E37 » depuis l'interface de commande à distance.
- Utilisez la commande **READ?** ou **INITiate** pour lancer la mesure.

Voir également

CONFigure?

MEASure[:VOLTage][:DC]:RATio?

Sous-système DATA

Ce sous-système vous permet de configurer et de supprimer des données de la mémoire de mesures. L'instrument efface toutes les mesures de la mémoire lorsque la configuration de mesure change ou lorsque l'une des commandes suivantes est exécutée : **INITiate**, **MEASure:<fonction>?**, **READ?**, ***RST**, **SYSTem:PRESet**.

Récapitulatif des commandes

DATA:LAST?

DATA:POINts?

DATA:POINts:EVENT:THReshold

DATA:REMOve?

DATA:LAST?

Renvoie la dernière mesure effectuée. Vous pouvez exécuter cette requête à tout moment, même pendant une série de mesures.

Paramètre	Renvoi type
(aucun)	(aucun)
Renvoyer la dernière mesure : DATA:LAST? Réponse type : Une seule mesure avec des unités. Si aucune donnée n'est disponible, 9.91E37 (pas un nombre) est renvoyé avec des unités. Exemple : +1.73730000E+00 Vcc	

DATA:POINts?

Renvoie le nombre total de mesures actuellement enregistrées dans la mémoire de mesures. Vous pouvez exécuter cette requête à tout moment, même pendant une série de mesures.

Paramètre	Renvoi type
(aucun)	(aucun)
Renvoyer le nombre de mesures actuellement enregistrées dans la mémoire de mesures : DATA:POIN? Réponse type : +215	

- Vous pouvez enregistrer jusqu'à 1 000 mesures dans la mémoire de lecture du modèle 34460A, 10 000 mesures dans celle du modèle 34461A, 50 000 mesures sur le modèle 34465A/70A (sans l'option MEM) ou 2 000 000 mesures sur le modèle 34465A/70A (avec l'option MEM).

DATA:POINts:EVENT:THReshold <nombre>

DATA:POINts:EVENT:THReshold?

Définit le nombre de mesures à enregistrer dans la mémoire de mesures avant de définir le bit 9 dans le registre des événements du groupe de registres de fonctionnement standard sur 1. Un registre d'événements est un registre en lecture seule qui verrouille des événements du registre de conditions. Lorsqu'un bit d'événement est actif, les événements suivants correspondant à ce bit sont ignorés.

REMARQUE Pour de plus amples informations sur le système d'état SCPI, reportez-vous à la section **Présentation du sous-système d'état**.

Paramètre	Renvoi type
34460A : 1 à 1 000 lectures 34461A : 1 à 10 000 lectures 34465A/70A : 1 à 50 000 lectures (sans l'option MEM) ou 1 à 2 000 000 lectures (avec l'option MEM) La valeur par défaut est 1 pour les deux modèles.	+125
Définir le seuil de la mémoire de mesures à 125 mesures : DATA:POIN:EVEN:THR 125	

- Pour signaler tous les événements suivants, le nombre de mesures doit d'abord redescendre sous le niveau seuil programmé avant d'atteindre à nouveau le seuil.
- Utilisez la commande **STATus:OPERation:ENABLE** pour activer le bit Seuil de mémoire (bit 9 du registre des événements de fonctionnement standard) à reporter dans l'octet d'état.
- Une fois le bit Seuil de mémoire (bit 9 du registre des événements de fonctionnement standard défini, il demeure défini jusqu'à son effacement par la commande **STATus:OPERation:EVENT?** ou ***CLS**.
- Le registre des conditions de fonctionnement standard indique la condition actuelle. Pour de plus amples informations, reportez-vous à la section **Présentation du sous-système STATus**.
- Ce paramètre est défini à sa valeur par défaut après une réinitialisation de la configuration d'usine (***RST**) ou un pré réglage de l'instrument (**SYSTem:PRESet**).

DATA:REMove? <nombre_lectures> [,WAIT]

Lit et efface <nombre_lectures> mesures de la mémoire de mesures. Si moins de <nombre_lectures> mesures sont disponibles, la requête renvoie une erreur, sauf si le paramètre WAIT est spécifié, auquel cas la requête patiente jusqu'à ce que <nombre_lectures> mesures soient disponibles.

Paramètre	Renvoi type
34460A : 1 à 1 000 lectures 34461A : 1 à 10 000 lectures 34465A/70A : 1 à 50 000 lectures (sans l'option MEM) ou 1 à 2 000 000 lectures (avec l'option MEM)	(aucun)
Lire et effacer les trois lectures les plus anciennes de la mémoire de mesures :	
DATA:REMove? 3	
Réponse type : -4.97215654E-01,-4.97343268E-01,-4.97121213E-01	

- Les requêtes **R?** et **DATA:REMove?** peuvent être utilisées au cours d'une longue série de lectures pour supprimer régulièrement des mesures de la mémoire afin d'éviter une saturation de cette dernière. La commande **R?** n'attend pas la fin de toutes les mesures. Elle envoie les mesures terminées au moment où l'instrument reçoit la commande. Utilisez les commandes **Read?** ou **Fetch?** afin que l'instrument attende que toutes les mesures soient terminées avant de les envoyer.
- Vous pouvez stocker jusqu'à 1 000 mesures dans la mémoire de mesures du modèle 34460A, 10 000 mesures dans celle du modèle 34461A, 50 000 mesures sur le modèle 34465A/70A (sans l'option MEM) ou 2 000 000 mesures sur le modèle 34465A/70A (avec l'option MEM). Si la mémoire de mesures est saturée, les nouvelles mesures remplacent les anciennes mesures enregistrées ; les mesures les plus récentes sont toujours conservées. Aucune erreur n'est générée. Toutefois, le bit Reading Mem Ovfl (bit 14) est défini dans le registre de conditions du registre des données douteuses (voir la section **Présentation du système d'état**).

Sous-système DISPlay

Ce sous-système contrôle l'écran de l'instrument.

Récapitulatif des commandes

DISPlay[:STATe]

DISPlay:TEXT[:DATA]

DISPlay:TEXT:CLEAr

DISPlay:VIEW

DISPlay[:STATe] {ON|1|OFF|0}

DISPlay[:STATe]?

Active ou désactive l'écran du panneau avant. Lorsqu'il est désactivé, l'écran s'atténue et tous les voyants sont désactivés. Cependant, l'écran reste allumé.

Paramètre	Renvoi type
{ON 1 OFF 0}. Valeur par défaut : ON.	0 (OFF) ou 1 (ON)
Désactiver l'écran :	
DISP OFF	

- La désactivation de l'écran accélère l'exécution des commandes à partir de l'interface de commande à distance et offre une sécurité de base.
- L'envoi de la commande **DISPlay:TEXT <chaîne>** entraîne l'affichage du texte, même avec **DISP:STAT OFF**.
- L'écran est activé lorsque l'instrument est remis sous tension ou lorsque vous revenez à l'utilisation locale (panneau avant) en appuyant sur la touche **[Local]** du panneau avant.

DISPlay:TEXT[:DATA] "<chaîne>"

DISPlay:TEXT[:DATA]?

Affiche un message textuel sur l'écran du panneau avant.

Paramètre	Renvoi type
Chaîne entre guillemets contenant jusqu'à 40 caractères. Vous pouvez utiliser des lettres (A-Z), des chiffres (0-9) et des caractères spéciaux comme @, %, *, etc.	"Test in progress..."
Valeur par défaut : ""	
Afficher un message à l'écran :	
DISP:TEXT "Test in progress..."	

- L'envoi de la commande **DISPlay:TEXT <chaîne>** entraîne l'affichage du texte, même avec **DISP:STAT OFF**.

Référence de programmation SCPI

- Lorsqu'un message est affiché, les informations relatives au fonctionnement actuel de l'instrument ne sont pas envoyées à l'écran du panneau avant.
- Le texte affiché n'est pas affecté par la commande ***RST**. Il est effacé à la mise sous tension.

DISPlay:TEXT:CLEar

Efface le message textuel de l'écran.

Paramètre	Renvoi type
(aucun)	(aucun)
Effacer le message affiché :	
DISP:TEXT:CLE	

- Associée à **DISPlay ON**, la commande DISP:TEXT:CLEar ramène l'écran en mode normal.
- Avec **DISPlay OFF**, DISP:TEXT:CLEar efface le message et l'écran reste désactivé. Pour activer l'écran, exécutez la commande **DISPlay ON** ou appuyez sur la touche **[Local]** du panneau avant.
- Le texte affiché n'est pas affecté par la commande ***RST**. Il est effacé à la mise sous tension.

DISPlay:VIEW {NUMeric|HISTogram|TCHart|METER}

DISPlay:VIEW?

Indique si les données de mesure sont affichées sous forme numérique, d'histogramme, de diagramme de tendance (non disponible sur le modèle 34460A) ou de barre de mesure.

Paramètre	Renvoi type
{NUMeric HISTogram TCHart METER}. Valeur par défaut : NUM.	HIST
Afficher un histogramme :	
DISP:VIEW HIST	

- L'écran n'est pas activé si son état est OFF.
- Ce paramètre est défini à sa valeur par défaut après une réinitialisation de la configuration d'usine (***RST**) ou un pré réglage de l'instrument (**SYSTem:PRESet**).

Sous-système FORMat

Ce sous-système concerne uniquement les modèles 34465A et 34470A.

Récapitulatif des commandes

FORMat:BORDER

FORMat[:DATA]

FORMat:BORDER {NORMAL|SWAPped}

FORMat:BORDER?

Utilisé pour les transferts de blocs de données binaires uniquement. Sélectionne l'ordre des octets pour les transferts de blocs binaires à l'aide des commandes MEASure?, READ?, FETCh?, DATA:REMove? et R?.

Paramètre	Renvoi type
{NORMAL SWAPped} (voir les points d'énumération ci-dessous). Valeur par défaut : NORM.	NORM
Sélectionner l'ordre d'octets inversé :	
FORMat:BORDER SWAP	

- Concerne uniquement les modèles 34465A et 34470A.
- Dans l'ordre d'octets *NORMAL* (valeur par défaut), le bit de poids fort (MSB) de chaque point de données est considéré en premier lieu.
- Dans l'ordre d'octets *SWAPped*, le bit de poids faible (LSB) de chaque point de données est considéré en premier lieu. La plupart des ordinateurs utilisent l'ordre d'octets « inversé ».
- L'ordre d'octets sélectionné est stocké dans la mémoire non volatile et n'est pas affecté par la remise sous tension de l'instrument. La valeur par défaut est rétablie après une réinitialisation de la configuration d'usine (*RST) ou après un préréglage de l'instrument (SYSTEM:PRESet).

FORMat[:DATA] {ASCIi|REAL} [, <longueur>]

FORMat[:DATA]?

Définit le format de données sur ASCII ou REAL. Affecte le format de données des commandes MEASure?, READ?, FETCh?, DATA:REMove? et R? uniquement.

Paramètre	Renvoi type
<longueur> ASCII : "9" ou REAL : "64"	ASC,9
Spécifier le format de données REAL 64 bits :	
FORM:DATA REAL,64 ou FORM:DATA REAL	

Référence de programmation SCPI

- Concerne uniquement les modèles 34465A et 34470A.
- Si le format ASCII est spécifié, les données numériques sont transférées sous forme de caractères ASCII. Les nombres sont séparés par des virgules tel que spécifié dans la norme IEEE 488.2. Le paramètre <longueur> est facultatif, mais « 9 » est la valeur par défaut et la seule valeur autorisée, et l'instrument renvoie 9 chiffres significatifs (exemple : +4.57553816E-05).
- Si le format REAL est spécifié, les données numériques sont transférées sous forme de données binaires REAL au format de bloc de longueur définie IEEE 488.2. Le paramètre <longueur> est facultatif, mais « 64 » est la valeur par défaut et la seule valeur autorisée. L'ordre des octets est contrôlé par la commande **FORMat:BOReR**.

Sous-système HCOPy

Le sous-système HCOPy génère des images d'écran (« captures d'écran »).

Exemple

L'exemple suivant capture et renvoie l'image d'écran au format BMP.

```
HCOP:SDUM:DATA:FORM BMP
HCOP:SDUM:DATA?
```

HCOPy:SDUMp:DATA?

Renvoie l'image d'écran du panneau avant (« capture d'écran »).

Paramètre	Renvoi type
(aucun)	(Bloc binaire de longueur définie contenant l'image.) Un bloc binaire de longueur définie permet de transmettre des données sous forme de série d'octets de données 8 bits. Cela est particulièrement utile pour transférer de grandes quantités de données ou des codes ASCII étendus sur 8 bits.
Voir l' exemple .	

- La commande **HCOPy:SDUMp:DATA:FORMat** spécifie le format de l'image (PNG ou BMP).

HCOPy:SDUMp:DATA:FORMat {PNG|BMP}

HCOPy:SDUMp:DATA:FORMat?

Spécifie le format des images renvoyées par la commande **HCOPy:SDUMp:DATA?**.

Paramètre	Renvoi type
{PNG BMP}. Valeur par défaut : PNG	PNG ou BMP
Voir l' exemple .	

Commandes courantes IEEE 488.2

Ces commandes et requêtes sont associées à la norme IEEE 488.2.

Récapitulatif des commandes

*CAL?

*CLS

*ESE

*ESR?

*IDN?

*LRN?

*OPC

*OPC?

*OPT?

*PSC

*RCL

*RST

*SAV

*SRE

*STB?

*TRG

*TST?

*WAI

Registre des événements standard

Le tableau ci-dessous décrit le registre des événements standard.

Numéro de bit	Nom du bit	Valeur décimale	Définition
0	Opération terminée	1	Toutes les commandes précédant et incluant *OPC sont exécutées.
1	Non utilisé	2	La valeur 0 est renvoyée.
2	Erreur de requête	4	L'instrument a tenté de lire le tampon de sortie, mais celui-ci était vide. Ou bien une nouvelle commande a été passée avant de lire une requête précédente. Ou encore les deux tampons d'entrée et de sortie sont saturés.
3	Erreur spécifique à l'instrument	8	Une erreur spécifique à l'instrument, notamment une erreur d'autotest ou une erreur d'étalonnage, s'est produite (un erreur dans la plage -300 ou une erreur positive a été générée). Pour une liste complète des messages d'erreur SCPI, reportez-vous à la section Messages d'erreur SCPI .
4	Erreur d'exécution	16	Une erreur d'exécution s'est produite (une erreur dans la plage -200 a été générée).
5	Erreur de commande	32	Une erreur de syntaxe de commande s'est produite (une erreur dans la plage -100 a été générée).
6	Non utilisé	64	La valeur 0 est renvoyée.
7	Mise sous tension	128	L'alimentation a été coupée et rétablie depuis la dernière lecture ou le dernier effacement du registre des événements.

Registre d'octet d'état

Le tableau ci-dessous décrit le registre de l'octet d'état.

Numéro de bit	Nom du bit	Valeur décimale	Définition
0	Non utilisé	1	(Réservé à une utilisation ultérieure)
1	Non utilisé	2	(Réservé à une utilisation ultérieure)
2	File d'erreurs	4	Une ou plusieurs erreurs ont été stockées dans la File d'erreurs. Utilisez la commande SYSTem:ERRor? pour lire et supprimer les erreurs.
3	Récapitulatif des données douteuses	8	Un ou plusieurs bits sont activés dans le registre des données douteuses (les bits doivent être activés, voir STATus:QUESTionable:ENABLE).
4	Message disponible	16	Des données sont disponibles dans le tampon de sortie de l'instrument.
5	Récapitulatif des événements standard	32	Un ou plusieurs bits sont activés dans le registre des événements standard (les bits doivent être activés, voir *ESE).
6	Récapitulatif général	64	Un ou plusieurs bits sont définis dans le registre d'octet d'état et peuvent entraîner une demande de service (Request for Service - RQS). Les bits doivent être activés avec la commande *SRE .
7	Récapitulatif du fonctionnement standard	128	Un ou plusieurs bits sont définis dans le registre de fonctionnement standard (les bits doivent être activés, voir STATus:OPERation:ENABLE).

***CAL?**

Requête d'étalonnage. Effectue un étalonnage automatique (autocal) et renvoie le résultat.

Paramètre	Renvoi type
(aucun)	+0 (aucune erreur) +1 (erreur d'étalonnage)
Effectuer un étalonnage automatique et renvoyer le résultat :	
*CAL?	

- (34465A/70A uniquement)
- L'étalonnage automatique ne prend que quelques secondes.
- L'étalonnage automatique compense la dérive provoquée par les variations de temps et de température dans les mesures en tension continue et de résistance, et ajuste certains aspects d'autres fonctions de mesure.
- Une fois l'étalonnage automatique terminé, l'instrument retourne à l'état précédant l'opération.

***CLS**

Commande d'effacement de l'état. Efface les registres des événements dans tous les groupes de registres. Efface également la file d'erreurs.

Paramètre	Renvoi type
(aucun)	(aucun)
Effacer les bits du registre des événements et la file d'erreurs :	
*CLS	

***ESE <valeur_activation>**

***ESE?**

Commande et requête d'activation de l'état des événements. Active les bits dans le registre d'activation du groupe de **registres des événements standard**. Les bits sélectionnés sont ensuite reportés dans le bit 5 du registre d'octet d'état. Un registre d'activation définit les bits du registre des événements qui seront reportés dans le groupe de registres d'octet d'état. Vous pouvez lire ou écrire dans un registre d'activation.

REMARQUE Pour de plus amples informations sur le système d'état SCPI, reportez-vous à la section **Présentation du sous-système d'état**.

Paramètre	Renvoi type
Somme décimale des des bits du registre (valeur par défaut : 0) Par exemple, pour activer le bit 2 (valeur 4), le bit 3 (valeur 8) et le bit 7 (valeur 128), la somme décimale correspondante est 140 (4 + 8 + 128). Valeur par défaut : 0.	+48
Configurer 100 mesures en tension continue et activer la génération d'une requête de service (SRQ) lorsque les mesures sont terminées : *CLS *ESE 1 *SRE 32 CONF:VOLT:DC SAMP:COUN 100 INIT *OPC	

- Utilisez la commande ***PSC** pour contrôler si le registre d'activation des événements standard est effacé à la mise sous tension. Par exemple, la commande ***PSC 0** conserve le contenu du registre d'activation lorsque l'instrument est éteint puis rallumé.
- La commande ***CLS** efface le registre des événements, mais pas le registre d'activation.
- Le paramètre <activation> est non volatile. Il ne change pas après une réinitialisation de la configuration d'usine (***RST**), un pré réglage de l'instrument (**SYSTem:PRESet**), un pré réglage d'état (**STATus:PRESet**) ou un effacement d'état (***CLS**).

***ESR?**

Requête du registre d'état des événements standard. Effectue une requête dans le registre des événements du groupe de **registres des événements standard**.

Un registre d'événements est un registre en lecture seule qui verrouille des événements du registre de conditions. Lorsqu'un bit d'événement est actif, les événements suivants correspondant à ce bit sont ignorés.

Paramètre	Renvoi type
(aucun)	+24
Lire le registre des événements (bits 3 et 4 activés) :	
*ESR?	

- Pour être signalé dans le registre d'octet d'état, les bits correspondants du registre d'activation doivent être activés par la commande ***ESE**.
- Une ou toutes les conditions peuvent être reportées dans le bit Récapitulatif des événements standard par le registre d'activation. Pour activer le masque du registre d'activation, écrivez une valeur décimale dans le registre avec la commande ***ESE**.
- Lorsqu'un bit est activé, il reste défini jusqu'à son effacement en lisant le registre des événements ou en envoyant la commande ***CLS** (effacement d'état).

***IDN?**

Requête d'identification. Renvoie la chaîne d'identification de l'instrument.

Paramètre	Renvoi type
(aucun)	(voir ci-dessous)
Renvoyer la chaîne d'identification de l'instrument :	
*IDN?	

- **Pour les révisions du microprogramme précédant la version 2.0**, la chaîne d'identification contient ces quatre champs séparés par des virgules :

Nom du fabricant, Numéro de modèle, Numéro de série, Code de révision

Si la commande **SYSTem:IDENtify DEFault** est définie, la chaîne renvoyée présente le format suivant :

Agilent Technologies,34460A,<numéro_de_série>,h.ff.ff-pp.pp-mm.mm-gg.gg-bb-fp

Agilent Technologies,34461A,<numéro_de_série>,h.ff.ff-pp.pp-mm.mm-gg.gg-bb-fp

Si la commande **SYSTem:IDENtify HP34401A** est définie, la chaîne renvoyée présente le format suivant :

HEWLETT-PACKARD,34401A,<Numéro de série>,h.ff.ff-pp.pp-mm.mm-gg.gg-bb-fp

Où :

h. - Révision du matériel

ff.ff - Révision du microprogramme principal

pp.pp - Révision du microprogramme du panneau avant

mm.mm - Révision du microprogramme de la carte de mesure

gg.gg - Révision FPGA de la carte de mesure

bb - Révision de la carte de mesure

fp - Révision de la carte du panneau avant

Référence de programmation SCPI

- **Pour la révision du microprogramme 2.0 et version ultérieure**, la chaîne d'identification contient ces quatre champs séparés par des virgules :

Nom du fabricant, Numéro de modèle, Numéro de série, Code de révision

Si la commande **SYSTem:IDENTify DEFault** est définie, la chaîne renvoyée présente le format suivant :

Keysight Technologies,34460A,<Numéro de série>,h.ff.ff-pp.pp-mm.mm-gg.gg-bb-fp
Keysight Technologies,34461A,<Numéro de série>,h.ff.ff-pp.pp-mm.mm-gg.gg-bb-fp
Keysight Technologies,34465A,<Numéro de série>,h.ff.ff-pp.pp-mm.mm-gg.gg-bb-fp
Keysight Technologies,34470A,<Numéro de série>,h.ff.ff-pp.pp-mm.mm-gg.gg-bb-fp

Si la commande **SYSTem:IDENTify DEFault** est définie, la chaîne renvoyée présente le format suivant (modèles 34460A ou 34461A uniquement) :

Agilent Technologies,34460A,<numéro_de_série>,h.ff.ff-pp.pp-mm.mm-gg.gg-bb-fp
Agilent Technologies,34461A,<numéro_de_série>,h.ff.ff-pp.pp-mm.mm-gg.gg-bb-fp

Si la commande **SYSTem:IDENTify HP34401A** est définie, la chaîne renvoyée présente le format suivant :

HEWLETT-PACKARD,34401A,<Numéro de série>,h.ff.ff-pp.pp-mm.mm-gg.gg-bb-fp

Si la commande **SYSTem:IDENTify AT34410A ou AT34411A** est définie, la chaîne renvoyée présente le format suivant (modèles 34465A ou 34470A uniquement) :

Agilent Technologies,34410A,<numéro_de_série>,h.ff.ff-pp.pp-mm.mm-gg.gg-bb-fp
Agilent Technologies,34411A,<numéro_de_série>,h.ff.ff-pp.pp-mm.mm-gg.gg-bb-fp

Où

h. - Révision du matériel

ff.ff - Révision du microprogramme principal

pp.pp - Révision du microprogramme du panneau avant

mm.mm - Révision du microprogramme de la carte de mesure

gg.gg - Révision FPGA de la carte de mesure

bb - Révision de la carte de mesure

fp - Révision de la carte du panneau avant

***LRN?**

Revoit une chaîne ASCII de toutes les commandes requises pour rétablir la configuration actuelle de l'instrument.

Paramètre	Renvoi type
(aucun)	Chaîne ASCII de commandes SCPI, délimitée par un point virgule (« ; ») entre les commandes.
Renvoyer la chaîne d'apprentissage :	
*LRN?	

- Certains paramètres peuvent être définis à l'aide des versions [SENSe:]FREQuency ou [SENSe:]PERiod de la même commande. La chaîne *LRN renvoie toujours la version FREQuency de la commande, même si le paramètre a été défini via la version PERiod. De même, les paramètres pouvant être définis à l'aide des versions RESistance ou FRESistance de la même commande renvoient toujours la version FRESistance.

***OPC**

Place le bit « Opération terminée » (bit 0) dans le registre des événements standard à la fin de l'opération en cours.

Paramètre	Renvoi type
(aucun)	(aucun)
Configurer 100 mesures en tension continue et activer la génération d'une requête de service (SRQ) lorsque les mesures sont terminées :	
*CLS *ESE 1 *SRE 32 CONF:VOLT:DC SAMP:COUN 100 INIT *OPC	

- Les autres commandes peuvent être exécutées avant que le bit Opération terminée ne soit positionné.
- *OPC diffère de la commande *OPC? en ce sens qu'elle active un bit d'état et génère la valeur « 1 » lorsque l'opération en cours est terminée.

***OPC?**

Renvoie la valeur 1 dans le tampon de sortie après la fin des commandes en attente. Les autres commandes ne peuvent être exécutées tant que cette commande n'est pas exécutée.

Paramètre	Renvoi type
(aucun)	1
Configurer 100 mesures en tension continue et renvoyer « 1 » à la fin des mesures :	
CONF:VOLT:DC	
SAMP:COUN 100	
INIT	
*OPC?	

- Utilisez cette commande pour synchroniser votre application avec l'instrument.
- *OPC diffère de la commande *OPC? en ce sens qu'elle active un bit d'état et génère la valeur « 1 » lorsque l'opération en cours est terminée.

***OPT?**

Renvoiez une chaîne de caractères identifiant toutes les options installées.

Paramètre	Renvoi type
(aucun)	(voir ci-dessous)
Renvoyer les options installées :	
*OPT?	

- Cette requête renvoie une chaîne de caractères au format suivant :

```
34460A : {GPB|0},{LAN|0},{SEC|0}
34461A : {GPB|0},{SEC|0}
34465A/70A : {GPB|0},{SEC|0},{DIG|0},{MEM|0}
```

La valeur 0 est renvoyée pour les options qui ne sont pas installées. Par exemple, un échantillon 34461A avec l'option GBIP installée renvoie GPB,0. Un modèle 34460A avec uniquement les options GPB et SEC installées renvoie GPB,0,SEC.

- Les options varient en fonction du modèle, comme **indiqué ici**.

PSC {0|1}**PSC?**

Effacement de l'état à la mise sous tension. Active (1) ou désactive (0) l'effacement de certains registres d'activation à la mise sous tension :

- Registre des données douteuses (**STATus:QUEStionable:ENABLE**)
- Registre de fonctionnement standard (**STATus:OPERation:ENABLE**)
- Registre de conditions de l'octet d'état (***SRE**).
- Registre d'activation des événements standard (***ESE**).

REMARQUE La commande ***PSC** affecte uniquement l'effacement des registres d'activation, pas celui des registres de conditions ou d'événements. Pour de plus amples informations sur le système d'état SCPI, reportez-vous à la section **Présentation du sous-système d'état**.

Paramètre	Renvoi type
{0 1}. Valeur par défaut : 1	0 ou 1
Désactiver l'effacement à la mise sous tension des registres concernés :	
*PSC 0	

RCL {0|1|2|3|4}**SAV {0|1|2|3|4}**

Enregistre la configuration actuelle de l'instrument dans ou rappelle la configuration de l'instrument depuis le fichier de configuration *STATE_<n>.sta*, situé dans le dossier racine du système de fichiers flash interne, où *n* correspond au nombre spécifié.

Paramètre	Renvoi type
{0 1 2 3 4}	(aucun)
Enregistrer l'état de l'instrument dans le fichier de configuration <i>STATE_1.sta</i> , situé dans le dossier racine du système de fichiers flash interne :	
*SAV 1	

- ***SAV <n>** est équivalent à **MMEMory:STORE:STATe "INT:\STATE_<n>.sta"**.
- ***RCL <n>** est équivalent à **MMEMory:LOAD:STATe "INT:\STATE_<n>.sta"**.
- Le fichier de configuration créé par la commande ***SAV 0**, appelé *STATE_0.sta*, est situé dans le dossier racine du système de fichiers flash interne. Il est remplacé par l'état d'extinction de l'instrument lorsque l'alimentation est rétablie.
- Les paramètres d'activation d'état de l'instrument sont stockés dans la mémoire volatile. Ils ne changent pas lorsque l'instrument est remis sous tension, après réinitialisation de la configuration d'usine (***RST**) ou après un préreglage de l'instrument (**SYSTem:PRESet**).

***RST**

Rétablir l'état par défaut de l'instrument. Cette commande est similaire à **SYSTem:PRESet**. La différence est que la commande ***RST** réinitialise l'instrument pour une utilisation de SCPI alors que la commande **SYSTem:PRESet** réinitialise l'instrument pour une utilisation du panneau avant. Par conséquent, la commande ***RST** désactive l'histogramme et les statistiques, alors que la commande **SYSTem:PRESet** les active.

Paramètre	Renvoi type
(aucun)	(aucun)
Réinitialiser l'instrument :	
*RST	

- N'affecte pas les états enregistrés de l'instrument (voir ***SAV**).

***SRE <valeur_activation>**

***SRE?**

Activation d'une demande de service. Active les bits du registre d'activation du groupe de registres d'octet d'état. Un registre d'activation définit les bits du registre des événements qui seront reportés dans le groupe de registres d'octet d'état. Vous pouvez lire ou écrire dans un registre d'activation.

Paramètre	Renvoi type
Somme décimale des bits du registre (valeur par défaut : 0) Par exemple, pour activer le bit 2 (valeur 4), le bit 3 (valeur 8) et le bit 7 (valeur 128), la somme décimale correspondante est 140 (4 + 8 + 128). Valeur par défaut : 0.	+24
Activer les bits 3 et 4 du registre d'activation :	
*SRE 24	

- Pour activer des bits particuliers, spécifiez la valeur décimale correspondant à la somme binaire pondérée des bits du registre. Les bits sélectionnés sont ensuite récapitulés dans le bit 6 (Récapitulatif général) du registre d'octet d'état. Si l'un des bits sélectionnés passe de 0 à 1, l'instrument génère un signal de demande de service.
- La commande ***CLS** efface le registre des événements, mais pas le registre d'activation. Un registre d'événements est un registre en lecture seule qui verrouille des événements du registre de conditions. Lorsqu'un bit d'événement est actif, les événements suivants correspondant à ce bit sont ignorés.
- La commande ***PSC** (effacement de l'état à la mise sous tension) détermine si le registre d'activation de l'octet d'état est effacé à la mise sous tension. Par exemple, la commande ***PSC 0** conserve le contenu du registre d'activation lorsque l'instrument est éteint puis rallumé.
- La commande ***RST** n'efface pas le registre d'activation de l'octet d'état.

***STB?**

Demande de lecture de l'octet d'état. Effectue une requête dans le groupe de **registres d'octet d'état** et renvoie une valeur décimale égale à la somme binaire pondérée de tous les bits définis dans le registre.

Un registre de conditions surveille en permanence l'état de l'instrument. Les bits du registre de conditions sont mis à jour en temps réel ; ils ne sont ni verrouillés ni mis en mémoire tampon.

Paramètre	Renvoi type
(aucun)	+40
Lire le registre de conditions (bits 3 et 5 activés) : *STB?	

- Similaire à l'interrogation série, mais traitée comme une autre commande de l'instrument. Ce registre est en lecture seule ; les bits ne sont pas effacés une fois lus.
- Renvoie le même résultat que l'interrogation série, mais la commande ***STB?** n'efface pas le bit 6 (Récapitulatif général).
- La remise sous tension de l'instrument et l'envoi de la commande ***RST** entraînent l'effacement de tous les bits du registre de conditions.

***TRG**

Déclenche l'instrument si la commande **TRIGger:SOURce BUS** est sélectionnée.

Paramètre	Renvoi type
(aucun)	(aucun)
Renvoyer cinq mesures en tension continue à l'aide d'un déclenchement logiciel pour lancer les mesures : CONF:VOLT:DC SAMP:COUN 5 TRIG:SOUR BUS INIT *TRG FETCH? Réponse type : +1.00520000E+01, ... (5 mesures)	

- Après avoir défini la source de déclenchement, vous devez envoyer la commande **INITiate** pour placer le multimètre à l'état « en attente de déclenchement ». La commande ***TRG** n'est acceptée que si le multimètre numérique est à l'état « en attente de déclenchement ».

***TST?**

Effectue un autotest de base de l'instrument et renvoie une indication de réussite/d'échec. L'autotest **TEST:ALL?** est plus complet que l'autotest ***TST?**.

Paramètre	Renvoi type
(aucun)	+0 (réussite) ou +1 (échec) (un ou plusieurs tests ont échoué)
Effectuer un autotest :	
*TST?	

- La réalisation de l'autotest prend quelques secondes.
- Si un ou plusieurs test échouent, la requête renvoie +1 et enregistre une erreur dans la file d'erreurs. Pour une liste complète des messages d'erreur relatifs aux échecs d'autotest, reportez-vous à la section **Messages d'erreur d'autotest**.
- Une fois le test terminé, l'instrument retourne à l'état précédant l'autotest.

***WAI**

Configure le tampon de sortie de l'instrument afin qu'il attende la fin de toutes les opérations en attente avant d'exécuter d'autres commandes sur l'interface.

Paramètre	Renvoi type
(aucun)	(aucun)
Patienter jusqu'à la fin de toutes les opérations en attente :	
*WAI	

- Les changements de configuration et les mesures sont considérés comme des opérations en attente. Par conséquent, la commande ***WAI** provoque l'application de ces changements.

Sous-système LXI

Ce sous-système prend en charge la fonction LXI (LAN eXtensions for Instrumentation).

Récapitulatif des commandes

LXI:IDENtify[:STATe]

LXI:MDNS:ENABle

LXI:MDNS:HNAME[:RESolved]?

LXI:MDNS:SNAMe:DESired

LXI:MDNS:SNAMe[:RESolved]?

LXI:RESet

LXI:REStart

LXI:IDENtify[:STATe] {ON|1|OFF|0}

LXI:IDENtify[:STATe]?

Affiche/masque le voyant d'identité Web LXI sur l'écran.

Paramètre	Renvoi type
{ON 1 OFF 0}. Valeur par défaut : OFF.	0 (OFF) ou 1 (ON)
Activer le voyant d'identité Web LXI :	
LXI:IDEN ON	

- Ce voyant permet d'identifier le périphérique associé à l'adresse LAN.
- Appuyez sur la touche [Local] ou envoyez la commande *RST pour désactiver le voyant.

LXI:MDNS:ENABle {ON|1|OFF|0}

LXI:MDNS:ENABle?

Désactive/active le système mDNS (multicast Domain Name System), qui offre les fonctions d'un serveur DNS pour la détection d'un service dans un petit réseau non équipé d'un serveur DNS.

Paramètre	Renvoi type
{ON 1 OFF 0}. Valeur par défaut : ON.	0 (OFF) ou 1 (ON)
Activer mDNS :	
LXI:MDSN:ENAB ON	

- Ce paramètre est non volatile ; il n'est pas altéré par une remise sous tension, une réinitialisation de la configuration d'usine (*RST) ou un préreglage de l'instrument (SYSTem:PRESet).
- Ce paramètre est défini sur la valeur par défaut lorsque l'instrument est expédié de l'usine et après l'exécution de la commande SYSTem:SECurity:IMMediate.

LXI:MDNS:HNAME[:RESolved]?

Renvoie le nom d'hôte mDNS (unique) résolu au format K-<numéro_de_modèle>-<numéro_de_série>-N, où <numéro_de_série> correspond aux 5 derniers chiffres du numéro de série de l'instrument. La lettre N est un entier ajouté au besoin afin que le nom soit unique. Si nécessaire, le nom désiré peut être tronqué pour faire de la place à l'entier ajouté.

Paramètre	Renvoi type
(aucun)	"K-34460A-yyyyy", où yyyyy correspond aux cinq derniers chiffres du numéro de série.
Renvoyer le nom d'hôte mDNS résolu :	
LXI:MDNS:HNAME:RESolved?	

LXI:MDNS:SNAME:DESired "<nom>"

LXI:MDNS:SNAME:DESired?

Configure le nom du service mDNS désiré.

Paramètre	Renvoi type
Chaîne entre guillemets contenant jusqu'à 63 caractères. Valeur par défaut : "Keysight <numéro_de_modèle> Multimètre numérique - <numéro_de_série>" où <numéro_de_série> correspond aux cinq derniers chiffres du numéro de série de l'instrument.	"Multimètre numérique Keysight 34460A - 98765"
Configurer le nom du service mDNS souhaité :	
LXI:MDNS:SNAME:DES "LAB1-DMM"	

- Ce paramètre est non volatile ; il n'est pas altéré par une remise sous tension, une réinitialisation de la configuration d'usine (*RST) ou un pré réglage de l'instrument (SYSTem:PRESet).
- Ce paramètre est défini sur la valeur par défaut lorsque l'instrument est expédié de l'usine et après l'exécution de la commande SYSTem:SECurity:IMMediate.

LXI:MDNS:SNAME[:RESolved]?

Le nom du service mDNS résolu est le nom de service désiré (LXI:MDNS:SNAME:DESired), avec l'ajout éventuel de « (<N>) ». La lettre N est un entier ajouté au besoin afin que le nom soit unique. Si nécessaire, le nom désiré peut être tronqué pour faire de la place à l'entier ajouté.

Paramètre	Renvoi type
(aucun)	"Multimètre numérique Keysight 34461A - 00123"
Renvoyer le nom du service mDNS résolu :	
LXI:MDNS:SNAME:RESolved?	

LXI:RESet

Renvoie les paramètres LAN à un état connu, en commençant par DHCP et efface le mot de passe de l'interface Web. Si DHCP échoue, il utilise Auto-IP.

Paramètre	Renvoi type
(aucun)	(aucun)
Rétablir les paramètres LAN :	
LXI:RES	

- En fonction de votre réseau, le redémarrage de l'interface du réseau local peut prendre plusieurs secondes après l'envoi de cette commande.
- Si l'interface LAN ou des services LAN spécifiques (VXI-11, sockets, etc.) sont désactivés par la commande **SYSTem:COMMunicate:ENABLE**, vous devez réactiver séparément l'interface ou les services, et remettre l'instrument sous tension pour que le réseau local soit opérationnel.

LXI:REStart

Redémarre le réseau local avec les paramètres actuels spécifiés par les commandes **SYSTem:COMMunicate:LAN**.

Paramètre	Renvoi type
(aucun)	(aucun)
Redémarrer l'interface LAN :	
LXI:REST	

- En fonction de votre réseau, le redémarrage de l'interface du réseau local peut prendre plusieurs secondes après l'envoi de cette commande.
- Si l'interface LAN ou des services LAN spécifiques (VXI-11, sockets, etc.) sont désactivés par la commande **SYSTem:COMMunicate:ENABLE**, vous devez réactiver séparément l'interface ou les services, et remettre l'instrument sous tension pour que le réseau local soit opérationnel.

Sous-système MEASure

Les requêtes MEASure constituent le moyen le plus simple de programmer des mesures car elles utilisent toujours les paramètres de mesure par défaut. Vous définissez la fonction, la plage et la résolution dans une commande unique, mais vous ne pouvez pas modifier les valeurs par défaut des autres paramètres. Les résultats sont envoyés directement au tampon de sortie de l'instrument.

REMARQUE Une requête MEASure est une fonctionnalité équivalente à l'envoi de la commande CONFIGure, suivie immédiatement de la commande READ?. La différence est que les commandes CONFIGure vous permettent de modifier les paramètres entre les commandes CONFIGure et READ?

Récapitulatif des commandes

MEASure:CAPacitance?

MEASure:CONTInuity?

MEASure:CURRent:{AC|DC}?

MEASure:DIODE?

MEASure:{FREQuency|PERiod}?

MEASure:{RESistance|FRESistance}?

MEASure:TEMPerature?

MEASure[:VOLTage]:{AC|DC}?

MEASure[:VOLTage][:DC]:RATio?

Paramètres par défaut de MEASure?

Les requêtes MEASure? vous permettent de sélectionner la fonction, la plage et la résolution via une commande unique. Tous les autres paramètres sont définis à leurs valeurs par défaut (ci-dessous).

Mesure Paramètre	Paramètre par défaut
Filtre d'entrée secteur (bande passante)	20 Hz (filtre moyen)
Réglage automatique du zéro	Désactivé si le paramètre de résolution produit un nombre de NPLC < 1 Activé si le paramètre de résolution produit un nombre de NPLC ≥ 1
Plage	AUTO (notamment la plage de tension pour les mesures de fréquence et de période)
Échantillons par déclenchement	1 échantillon
Nombre de déclenchements	1 déclenchement
Retard de déclenchement	Retard automatique
Source de déclenchement	Immédiate
Pente de déclenchement	NEGative
Fonctions mathématiques	Désactivées. Les autres paramètres ne changent pas.
État Null par fonction	Désactivé

Utilisation de la requête MEASure?

L'exemple suivant illustre la configuration des mesures en tension continue, le déclenchement interne de l'instrument pour effectuer une mesure et la lecture de la mesure. La plage par défaut (commutation automatique de plage) et la résolution (10 PLC) sont utilisées pour la mesure.

```
MEAS:VOLT:DC?
```

Réponse type : +4.23450000E-03

L'exemple suivant illustre la configuration de l'instrument pour des mesures de résistance en 2 fils, le déclenchement de l'instrument pour effectuer une mesure et la lecture de la mesure. La plage 1 k Ω est sélectionnée avec une résolution de 0,1 Ω .

```
MEAS:RES? 1000,0.1
```

Réponse type : +3.27150000E+02

MEASure:CAPacitance? [{<plage>|AUTO|MIN|MAX|DEF} [, {<résolution>|MIN|MAX|DEF}]]

Définit tous les paramètres de mesure et de déclenchement à leurs **valeurs par défaut** pour les mesures de température et déclenche immédiatement une mesure. Les résultats sont envoyés directement au tampon de sortie de l'instrument.

Paramètre	Renvoi type
<plage> : {1 nF 10 nF 100 nF 1 µF 10 µF 100 µF}. Valeur par défaut : AUTO.	(aucun)
<résolution> : facultative et ignorée ; fixe à 4½ chiffres.	
Configurez les mesures de capacité. Puis, effectuez et lisez une mesure : MEAS:TEMP? Réponse type : +3.01534021E-10	

- Vous pouvez laisser la fonction de commutation automatique de plage sélectionner la plage de mesure ou bien sélectionner manuellement une plage fixe. La commutation automatique de plage sélectionne facilement la plage pour chaque mesure en fonction du signal d'entrée. Pour des mesures ultra rapides, utilisez la commutation manuelle (la commutation automatique peut nécessiter plus de temps pour la sélection de la plage).
- La commutation automatique de plage (AUTO ou DEFault) génère une erreur si vous spécifiez une <résolution> car l'instrument ne peut pas résoudre avec précision le temps d'intégration (notamment si l'entrée change continuellement). Si votre application requiert une commutation automatique de plage, spécifiez DEFault pour la <résolution> ou omettez complètement la <résolution>.
- La commutation automatique de plage descend d'une plage à moins de 10 % de la plage et augmente d'une plage à plus de 120 % de la plage. Pour les mesures de capacité uniquement, lorsque la fonction de commutation automatique de plage est désactivée, l'instrument ne signale pas de surcharge pour les lectures supérieures à 120 % de la plage. Une surcharge se produit uniquement une fois le délai de l'algorithme dépassé car la capacité appliquée est trop élevée pour l'algorithme à mesurer. Si vous appliquez une tension continue ou un court-circuit aux bornes d'entrée en mode de mesure de capacité, l'instrument rapporte une surcharge.
- Si le signal d'entrée est supérieur au signal pouvant être mesuré dans la plage manuelle spécifiée, l'instrument affiche l'indication *Overload* (Surcharge) sur le panneau avant et renvoie « 9.9E37 » depuis l'interface de commande à distance.

MEASure:CONTInuity?

Définit tous les paramètres de mesure et de déclenchement à leurs **valeurs par défaut** pour le test de continuité et déclenche immédiatement une mesure. Les résultats sont envoyés directement au tampon de sortie de l'instrument.

Paramètre	Renvoi type
(aucun)	(aucun)
Configurez l'instrument pour des mesures de continuité. Puis, effectuez et lisez une mesure :	
MEAS:CONT?	
Réponse type : +1.32130000E-02	

- La plage et la résolution sont fixes à 1 k Ω pour les tests de continuité (mesure de résistance en 2 fils).
- L'instrument émet un signal sonore (si l'avertisseur sonore est activé) pour chaque mesure inférieure ou égale au seuil de continuité ($\leq 10 \Omega$), et la mesure de résistance réelle s'affiche à l'écran.
- Entre 10 Ω et 1,2 k Ω , l'instrument affiche la mesure de résistance réelle sans aucun signal sonore. Au-delà de 1,2 k Ω , l'instrument affiche le message « OPEN » sans émettre de signal sonore.
- Les requêtes **FETCH?**, **READ?** et **MEASure:CONTInuity?** renvoient la résistance mesurée, quelle que soit sa valeur.

MEASure:CURRent:{AC|DC}? [{<plage>|AUTO|MIN|MAX|DEF} [, {<résolution>|MIN|MAX|DEF}]]

Définit tous les paramètres de mesure et de déclenchement à leurs **valeurs par défaut** pour les mesures en courant alternatif et en courant continu, et déclenche immédiatement une mesure. Les résultats sont envoyés directement au tampon de sortie de l'instrument.

Paramètre	Renvoi type
<plage> : {100 µA 1 mA 10 mA 100 mA 1 A 3 A 10 A}. Valeur par défaut : AUTO (commutation automatique de plage).	(aucun)
<résolution> (courant alternatif) : facultative et ignorée ; fixe à 6½ chiffres. <résolution> (courant continu) : Voir Tableau de résolution ou Plage, résolution et NPLC . La valeur par défaut est équivalente à 10 PLC.	
Spécifiez la <résolution> dans les unités de mesure (V, A, Hz, Ω, etc.).	
Configurez les mesures en courant alternatif avec la plage de 1 A. Puis, effectuez et lisez une mesure :	
MEAS:CURR:AC? 1	
Réponse type : +8.54430000E-01	

- Vous pouvez laisser la fonction de commutation automatique de plage sélectionner la plage de mesure ou bien sélectionner manuellement une plage fixe. La commutation automatique de plage sélectionne facilement la plage pour chaque mesure en fonction du signal d'entrée. Pour des mesures ultra rapides, utilisez la commutation manuelle (la commutation automatique peut nécessiter plus de temps pour la sélection de la plage).
- La commutation automatique de plage (AUTO ou DEFault) génère une erreur si vous spécifiez une <résolution> car l'instrument ne peut pas résoudre avec précision le temps d'intégration (notamment si l'entrée change continuellement). Si votre application requiert une commutation automatique de plage, spécifiez DEFault pour la <résolution> ou omettez complètement la <résolution>.
- La commutation automatique de plage descend d'une plage à moins de 10 % de la plage et augmente d'une plage à plus de 120 % de la plage.
- Si le signal d'entrée est supérieur au signal pouvant être mesuré dans la plage manuelle spécifiée, l'instrument affiche l'indication *Overload* (Surcharge) sur le panneau avant et renvoie « 9.9E37 » depuis l'interface de commande à distance.

MEASure:DIODe?

Définit tous les paramètres de mesure et de déclenchement à leurs **valeurs par défaut** pour les mesures de test de diodes et déclenche immédiatement une mesure. Les résultats sont envoyés directement au tampon de sortie de l'instrument.

Paramètre	Renvoi type
(aucun)	(aucun)
Configurer, effectuer et lire une mesure de diode par défaut :	
MEAS:DIOD?	
Réponse type : +1.32130000E-01	

- La plage et la résolution sont *fixes* pour les tests de diode ; la plage est de 1 Vcc (avec une sortie de source de courant de 1 mA).
- La tension est affichée sur le panneau avant si elle est comprise entre 0 et 5,05 V. L'instrument émet un signal sonore lorsque le signal passe dans la plage comprise entre 0,3 et 0,8 V (sauf si l'avertisseur sonore est désactivé). Si le signal dépasse 5,05 V, le panneau avant affiche « OPEN » et la valeur renvoyée par SCPI est 9.9E37.
- Les requêtes **FETCh?**, **READ?** et **MEASure:DIODe?** renvoient la tension mesurée, quelle que soit sa valeur.

MEASure:{FREQuency|PERiod}? [{<plage>|MIN|MAX|DEF} [, {<résolution>|MIN|MAX|DEF}]]

Définit tous les paramètres de mesure et de déclenchement à leurs **valeurs par défaut** pour les mesures de fréquence et de période, et déclenche immédiatement une mesure. Les résultats sont envoyés directement au tampon de sortie de l'instrument.

Paramètre	Renvoi type
<plage> : 3 Hz à 300 kHz. Valeur par défaut : 20 Hz. pour FREQuency	(aucun)
<plage> : 3,33 µs à 333,33 ms. Valeur par défaut : 50 ms (PERiod).	
<résolution> : Voir le tableau ci-dessous. Spécifiez la <résolution> dans les unités de mesure (V, A, Hz, Ω, etc.).	
Configurez les mesures de fréquence avec l'ouverture par défaut. Puis, effectuez et lisez une mesure : MEAS:FREQ? Réponse type : +1.32130000E+03	

- L'ouverture de 1 mS concerne uniquement les modèles 34465A et 34470A.
- Le paramètre <plage> de la fréquence ou de la période est uniquement nécessaire pour spécifier le paramètre de résolution de mesure. Il n'est pas nécessaire d'envoyer une nouvelle commande pour chaque nouvelle fréquence ou période à mesurer. Les paramètres <plage> et <résolution> affectent l'ouverture (temps de porte) comme suit :

Résolution (34460A/61A)	Résolution (34465A/70A)	Ouverture
Sans objet	100 ppm × <plage> (MAXimum)	1 ms
100 ppm × <plage> (MAXimum)	10 ppm × <plage> (DEFault)	10 ms
10 ppm × <plage> (DEFault)	1 ppm × <plage>	100 ms
1 ppm × <plage> (MINimum)	0,1 ppm × <plage> (MINimum)	1 s

- Le signal d'entrée pour les mesures de fréquence ou de période inclut un composant de *tension alternative*. Par défaut, cette commande utilise la commutation automatique de plage pour sélectionner la plage de tension.
- Si aucun signal n'est appliqué, la valeur 0 est renvoyée.

MEASure:{RESistance|FRESistance}? [{<plage>|AUTO|MIN|MAX|DEF} [, {<résolution>|MIN|MAX|DEF}]]

Définit tous les paramètres de mesure et de déclenchement à leurs **valeurs par défaut** pour les mesures de résistance en 4 fils (FRESistance) ou 2 fils (RESistance), et déclenche immédiatement une mesure. Les résultats sont envoyés directement au tampon de sortie de l'instrument.

Paramètre	Renvoi type
<plage> : 100 Ω, 1 kΩ, 10 kΩ, 100 kΩ, 1 MΩ, 10 MΩ, 100 MΩ, 1 GΩ, AUTO ou DEFault. Valeur par défaut : AUTO.	(aucun)
<résolution> : Voir Tableau de résolution ou Plage, résolution et NPLC . La valeur par défaut est équivalente à 10 PLC. Spécifiez la <résolution> dans les unités de mesure (V, A, Hz, Ω, etc.).	
Configurez les mesures de résistance en 4 fils avec la plage de 100 Ω et la résolution par défaut. Puis, effectuez et lisez une mesure :	
MEAS:FRES? 100	
Réponse type : +8.54530000E+01	

- La plage de 1 GΩ concerne uniquement les modèles 34465A et 34470A.
- Vous pouvez laisser la fonction de commutation automatique de plage sélectionner la plage de mesure ou bien sélectionner manuellement une plage fixe. La commutation automatique de plage sélectionne facilement la plage pour chaque mesure en fonction du signal d'entrée. Pour des mesures ultra rapides, utilisez la commutation manuelle (la commutation automatique peut nécessiter plus de temps pour la sélection de la plage).
- La commutation automatique de plage (AUTO ou DEFault) génère une erreur si vous spécifiez une <résolution> car l'instrument ne peut pas résoudre avec précision le temps d'intégration (notamment si l'entrée change continuellement). Si votre application requiert une commutation automatique de plage, spécifiez DEFault pour la <résolution> ou omettez complètement la <résolution>.
- La commutation automatique de plage descend d'une plage à moins de 10 % de la plage et augmente d'une plage à plus de 120 % de la plage.
- Si le signal d'entrée est supérieur au signal pouvant être mesuré dans la plage manuelle spécifiée, l'instrument affiche l'indication *Overload* (Surcharge) sur le panneau avant et renvoie « 9.9E37 » depuis l'interface de commande à distance.

MEASure:TEMPerature? [{FRTD|RTD|FTHermistor|THERmistor|TCouple|Default} [, {<type>|Default} [,1 [, {<résolution>|MIN|MAX|DEF}]]]]

Définit tous les paramètres de mesure et de déclenchement à leurs **valeurs par défaut** pour les mesures de température et déclenche immédiatement une mesure. Les résultats sont envoyés directement au tampon de sortie de l'instrument.

Paramètre	Renvoi type
<type_sonde> : {FRTD RTD FTHermistor THERmistor TCouple}. Valeur par défaut : FRTD.	(aucun)
<type> : 85 (seule valeur possible pour RTD/FRTD) ou 5 000 (seule valeur possible pour THERmistor/FTHermistor) ou E, J, K, N, R, T (TCouple).	
<résolution> : Voir Tableau de résolution ou Plage, résolution et NPLC . La valeur par défaut est équivalente à 10 PLC.	
Configurez une mesure de RTD en 4 fils avec la résolution par défaut. Puis, effectuez et lisez une mesure : MEAS:TEMP? FRTD,85 Réponse type : +2.12320000E+01	

- Les mesures par thermocouples (TC) concernent uniquement les modèles 34465A et 34470A.
- Pour les mesures de température, l'instrument sélectionne la plage en interne ; vous ne pouvez pas sélectionner la plage à utiliser. La plage (« 1 » est la seule valeur autorisée) est utilisée conjointement avec la résolution pour déterminer le nombre de cycles de tension d'alimentation (NPLC).
- Le paramètre <résolution> détermine uniquement le temps d'intégration. Il n'indique pas la résolution de la mesure de température. Ce paramètre est facultatif. Cependant, si vous indiquez le paramètre <résolution>, vous devez également spécifier « 1 » comme paramètre de plage implicite. Par exemple : CONF:TEMP RTD,85,1,0.000001 sélectionne le temps d'intégration de 10 PLC sur le modèle 34461A.
- Pour modifier les unités de température, utilisez la commande **UNIT:TEMPerature**.
- Pour les mesures de thermistance et de RTD, l'instrument sélectionne automatiquement la plage correcte en fonction de la mesure de résistance du capteur. Pour les mesures par thermocouples, la plage de 100 mV est sélectionnée.
- Pour les mesures par thermocouples, la référence interne est sélectionnée. Voir **SENSe:TEMPerature:TCouple:RJUNction:TYPE**.
- Si le signal d'entrée est supérieur au signal pouvant être mesuré dans la plage manuelle spécifiée, l'instrument affiche l'indication *Overload* (Surcharge) sur le panneau avant et renvoie « 9.9E37 » depuis l'interface de commande à distance.

MEASure[:VOLTage]:{AC|DC}? [{<plage>|AUTO|MIN|MAX|DEF} [, {<résolution>|MIN|MAX|DEF}]]

Définit tous les paramètres de mesure et de déclenchement à leurs **valeurs par défaut** pour les mesures en tension alternative et tension continue, et déclenche immédiatement une mesure. Les résultats sont envoyés directement au tampon de sortie de l'instrument.

AVERTISSEMENT

Le paramètre de plage maximal (MAX) est de 1 000 V. Cependant, la LIMITE DE SÉCURITÉ sur les bornes d'entrée HI/LO avant et arrière est de 750 Vca (eff.). La tension efficace vraie dépend du signal. Une onde sinusoïdale est limitée à 750 Vca (eff.), mais une onde carrée de 1 000 V crête est sûre. La connexion à l'alimentation secteur est en outre limitée à la catégorie de mesure II (300 V). Pour de plus amples informations sur les fonctions de sécurité et l'utilisation sans danger de cet instrument, reportez-vous à la section **Informations de sécurité et réglementaires**.

Paramètre	Renvoi type
<plage> : 100 mV, 1 V, 10 V, 100 V, 1 000 V, AUTO (valeur par défaut) ou DEFault	(aucun)
<résolution> (courant alternatif) : facultative et ignorée ; fixe à 6½ chiffres. <résolution> (courant continu) : Voir Tableau de résolution ou Plage, résolution et NPLC . La valeur par défaut est équivalente à 10 PLC. Spécifiez la <résolution> dans les unités de mesure (V, A, Hz, Ω, etc.).	
Configurez les mesures en tension continue avec la plage de 10 V et la résolution de 1 mV. Puis, effectuez et lisez une mesure :	
MEAS:VOLT:DC? 10,0.001	
Réponse type : +8.54530000E+01	

- Vous pouvez laisser la fonction de commutation automatique de plage sélectionner la plage de mesure ou bien sélectionner manuellement une plage fixe. La commutation automatique de plage sélectionne facilement la plage pour chaque mesure en fonction du signal d'entrée. Pour des mesures ultra rapides, utilisez la commutation manuelle (la commutation automatique peut nécessiter plus de temps pour la sélection de la plage).
- La commutation automatique de plage (AUTO ou DEFault) génère une erreur si vous spécifiez une <résolution> car l'instrument ne peut pas résoudre avec précision le temps d'intégration (notamment si l'entrée change continuellement). Si votre application requiert une commutation automatique de plage, spécifiez DEFault pour la <résolution> ou omettez complètement la <résolution>.
- La commutation automatique de plage descend d'une plage à moins de 10 % de la plage et augmente d'une plage à plus de 120 % de la plage.
- Si le signal d'entrée est supérieur au signal pouvant être mesuré dans la plage manuelle spécifiée, l'instrument affiche l'indication *Overload* (Surcharge) sur le panneau avant et renvoie « 9.9E37 » depuis l'interface de commande à distance.

MEASure[:VOLTage][:DC]:RATio? [{<plage>|AUTO|MIN|MAX|DEF} [, {<résolution>|MIN|MAX|DEF}]]

Définit tous les paramètres de mesure et de déclenchement à leurs **valeurs par défaut** pour les mesures de rapport de tension continue et déclenche immédiatement une mesure. Les résultats sont envoyés directement au tampon de sortie de l'instrument.

Pour calculer un rapport, l'instrument mesure une tension de référence continue appliquée à la borne de *mesure* et la tension de signal continue appliquée aux bornes d'*entrée*. Il utilise ensuite la formule suivante :

$$\text{Rapport} = \text{tension de signal continue} / \text{tension de référence continue}$$

Paramètre	Renvoi type
<plage> : 100 mV, 1 V, 10 V, 100 V, 1 000 V, AUTO (valeur par défaut) ou DEFault	(aucun)
<résolution> : Voir Tableau de résolution ou Plage, résolution et NPLC . La valeur par défaut est équivalente à 10 PLC.	
Configurez les mesures du rapport de tension continue avec une plage de 100 V et une résolution de 1 mV. Puis, effectuez et lisez une mesure :	
MEAS:VOLT:DC:RAT? 100,0.001	
Réponse type : +4.27150000E+00	

- Les bornes de *mesure* incluent une entrée mesurable maximale de ± 12 Vcc. La commutation automatique de plage est automatiquement sélectionnée pour les mesures de tension de référence sur les bornes de *mesure*.
- Les bornes d'*entrée* LO et de *mesure* LO doivent avoir une référence commune et leur différence de tension ne doit pas être supérieure à ± 2 V.
- La plage de mesure spécifiée s'applique uniquement au signal connecté aux bornes d'*entrée*. Le signal sur les bornes d'*entrée* peut être n'importe quelle tension continue jusqu'à 1 000 V.
- Pour les bornes d'*entrée*, vous pouvez laisser l'instrument sélectionner la plage de mesure à l'aide de la fonction de commutation automatique ou bien sélectionner une plage fixe à l'aide de la fonction de *commutation manuelle*. La fonction de commutation automatique détermine la plage à utiliser pour chaque mesure en fonction du signal d'entrée. Pour des mesures plus rapides, utilisez la fonction de commutation manuelle sur chaque mesure (un temps supplémentaire est nécessaire pour que la fonction de commutation automatique sélectionne une plage).
- La commutation automatique de plage (AUTO ou DEFault) génère une erreur si vous spécifiez une <résolution> car l'instrument ne peut pas résoudre avec précision le temps d'intégration (notamment si l'entrée change continuellement). Si votre application requiert une commutation automatique de plage, spécifiez DEFault pour la <résolution> ou omettez complètement la <résolution>.
- La commutation automatique de plage descend d'une plage à moins de 10 % de la plage et augmente d'une plage à plus de 120 % de la plage.
- Si le signal d'entrée est supérieur au signal pouvant être mesuré dans la plage manuelle spécifiée, l'instrument affiche l'indication *Overload* (Surcharge) sur le panneau avant et renvoie « 9.9E37 » depuis l'interface de commande à distance.

Sous-système MMEemory - Gestion de fichiers de base

Les commandes de gestion de fichiers de base du sous-système MMEemory sont répertoriées ci-dessous. Le sous-système MMEemory inclut également deux autres types de commandes :

Gestion des fichiers STATE et PREFERENCE

Transfert de données

Commandes et requêtes

MMEemory:CATalog[:ALL]?

MMEemory:CDIRectory

MMEemory:COPI

MMEemory:DElete

MMEemory:MDIRectory

MMEemory:MOVE

MMEemory:RDIRectory

Formats des dossiers et des fichiers

De nombreuses commandes MMEMory font référence à des dossiers et à des fichiers. Ces dernières présentent des structures particulières, décrites ci-dessous.

Format d'un <dossier>

- Le format d'un <dossier> est "[[<lecteur>:]<chemin>]", où <lecteur> peut être INTernal ou USB et <chemin> correspond au chemin d'accès au dossier et <spéc_fichier> désigne un sous-ensemble de fichiers.
- INTernal spécifie le système de fichiers flash interne. USB désigne un périphérique de stockage USB du panneau avant.
- Si <lecteur> est spécifié, <chemin> est interprété comme un chemin d'accès complet au dossier. Les chemins d'accès absolus commencent par « \ » ou « / » au niveau du répertoire racine <lecteur>.
- Si <lecteur> est omis <chemin> désigne le dossier spécifié par **MMEMory:CDIRectory**. Les chemins relatifs ne doivent PAS commencer par \ ou /.
- Les noms de dossiers et de fichiers ne doivent pas contenir les caractères suivants : \ / : * ? " < > |
- Le paramètre <dossier> ne doit pas contenir plus de 240 caractères.
- Le dossier spécifié doit exister et ne peut pas être marqué comme un dossier masqué ou système. L'exception est **MMEMory:MDIRectory**, qui crée un dossier. Pour la commande MMEMory:MDIRectory, tous les niveaux de dossier supérieurs au nouveau niveau doivent exister.

Format d'un <fichier>

- Le format d'un nom de fichier est "[[<lecteur>:]<chemin>]<nom_de_fichier>", où <lecteur> peut être INTernal ou USB, et <chemin> est un chemin d'accès à un dossier.
- INTernal spécifie le système de fichiers flash interne. USB désigne un périphérique de stockage USB du panneau avant.
- Si <lecteur> est spécifié, <chemin> est interprété comme un chemin d'accès complet au dossier. Les chemins d'accès absolus commencent par « \ » ou « / » au niveau du répertoire racine <lecteur>.
- Si <lecteur> est omis <chemin> désigne le dossier spécifié par **MMEMory:CDIRectory**. Les chemins relatifs ne doivent PAS commencer par \ ou /.
- Les noms de dossiers et de fichiers ne doivent pas contenir les caractères suivants : \ / : * ? " < > |
- La combinaison du nom de dossier et de fichier ne doit pas dépasser 240 caractères.

MMEMory:CATalog[:ALL]? [<dossier>[<spéc_fichier>]]

Renvoie une liste de fichiers dans le dossier spécifié.

Paramètre	Renvoi type
Tout nom de dossier valide ; par défaut, le dossier sélectionné par la commande MMEMory:CDIRectory	+1000000000,+327168572, "command.exe,,375808", "MyDCVMeas.sta,STAT,8192",MyData.csv,ASC,11265"
Répertorier tous les fichiers dans le dossier MyData de la mémoire de masse USB du panneau avant :	
MMEM:CAT? "USB:\MyData"	
Répertorier tous les fichiers de configuration dans le répertoire racine de la mémoire interne :	
MMEM:CAT? "INT:*.sta"	

- Si <spéc_fichier> est omis ou est *.* , la commande ou la requête traite tous les fichiers. Vous pouvez également utiliser l'astérisque (*) comme caractère générique : *.sta, abc*.*, etc.
- Le catalogue adopte le format suivant :

<mém_utilisée>,<mém_disponible>{"<liste_de_fichiers>"}

L'instrument renvoie deux nombres et une chaîne de caractères pour chaque fichier dans le dossier.

Le premier nombre correspond au nombre d'octets utilisés sur le lecteur. Le deuxième indique le nombre d'octets disponible. Chaque <liste_de_fichiers> est au format "<nom_de_fichier>,<type_de_fichier>,<taille_de_fichier>" (les guillemets sont également renvoyés), où <nom_de_fichier> est le nom du fichier avec son extension, le cas échéant ; <type_de_fichier> est STAT pour les fichiers STATE (.sta), ASC pour les fichiers de données (.csv), PREF pour les fichiers PREFERENCE (.prf), ou vide pour toutes les autres extensions ; <taille_de_fichier> est la taille des fichiers en octets.

- S'il n'y a pas de fichier, seules les valeurs <mém_utilisée> et <mém_disponible> sont renvoyées.
- L'instrument utilisant une faible quantité d'espace dans le système de fichiers flash à des fins d'utilisation interne, la valeur <mém_utilisée> n'est jamais égale à zéro.

MMEMory:CDIRectory <dossier>

MMEMory:CDIRectory?

MMEMory:MDIRectory <dossier>

MMEMory:RDIRectory <dossier>

MMEMory:CDIRectory sélectionne le dossier par défaut pour les commandes du sous-système MMEMory. Ce dossier doit exister ; il est utilisé lorsque les noms des dossiers ou des fichiers ne contiennent pas de nom de dossier ou de fichier. La requête renvoie le nom de dossier par défaut actuel.

MMEMory:MDIRectory crée un répertoire (dossier) sur le support de stockage de masse.

MMEMory:RDIRectory supprime un répertoire (dossier) sur le support de stockage de masse.

Paramètre	Renvoi type
Tout nom de répertoire contenant le nom du périphérique de stockage de masse. INT:\ par défaut.	"INT:\BACKUP"
Créer et supprimer un répertoire nommé « test » dans le système de mémoire de masse interne :	
MMEM:MDIR "test"	
MMEM:RDIR "test"	
Sélectionner le dossier \BACKUP dans le système de fichiers flash interne comme dossier par défaut :	
MMEM:CDIR "INT:\BACKUP"	
Renvoyer le dossier par défaut pour les commandes du sous-système MMEMory :	
MMEM:CDIR?	

- Ce paramètre est défini à sa valeur par défaut après une réinitialisation de la configuration d'usine (*RST) ou un pré réglage de l'instrument (SYSTem:PRESet).
- Vous pouvez supprimer uniquement un dossier vide. Sinon, l'instrument génère l'erreur « Directory not empty » (Répertoire non vide).

MMEMory:COPY <fichier 1>,<fichier 2>

Copie <fichier1> dans <fichier2>. Chaque nom de fichier doit inclure l'extension de fichier.

Paramètre	Renvoi type
Tout nom de fichier valide (les deux fichiers)	(aucun)
Copier le fichier de configuration du répertoire racine vers le dossier « Backup » du système de fichiers flash interne :	
MMEM:COPY "INT:\MyVoltMeas.sta","INT:\Backup"	

- Le fichier et le dossier source doivent exister et ne peuvent pas être masqués ou des fichiers/dossiers système.
- Le dossier de destination doit exister et ne peut pas être marqué comme un dossier masqué ou système.
- Si le fichier de destination existe, il est remplacé, sauf s'il est marqué comme un fichier masqué ou système.
- Pour copier un fichier dans un fichier du même nom dans un autre dossier, vous pouvez spécifier uniquement le <lecteur> et/ou le <chemin> de la <destination>.

MMEMory:DELeTe {<fichier>|<spéc_fichier>}

Supprime un fichier. Pour supprimer un dossier, utilisez la commande MMEMory:RDIRECTory.

Paramètre	Renvoi type
Tout nom de fichier valide , notamment l'extension ou <spéc_fichier>, comme décrit ci-dessous.	(aucun)
Supprimer un fichier du répertoire racine du système de fichiers flash interne :	
MMEM:DEL "INT:\MySetup.sta"	

- Le paramètre <spéc_fichier> peut inclure le caractère générique * : *.bmp, *.sta, abc*.*, etc.
- Le dossier spécifié doit exister et ne peut pas être marqué comme un dossier masqué ou système.
- La commande **SYSTEM:SECurity:IMMediate** permet de supprimer et de nettoyer tous les fichiers.

MMEMory:MOVE <fichier 1>,<fichier 2>

Déplace et/ou renomme <fichier1> à <fichier2>. Chaque nom de fichier doit inclure l'extension de fichier.

Paramètre	Renvoi type
Tout nom de fichier valide (les deux fichiers)	(aucun)
Déplacer le fichier de configuration spécifié du répertoire par défaut actuellement sélectionné vers le dossier « Backup » du système de fichiers flash interne : MMEM:MOVE "MyVoltMeas.sta","INT:\Backup"	

- Pour renommer un fichier, spécifiez le même dossier pour <fichier1> et <fichier2>.
- Pour déplacer un fichier dans un dossier du même nom dans un autre dossier, vous pouvez spécifier uniquement <lecteur>:<chemin> pour <fichier2>.

Sous-système MMEMory - Fichiers STATE et PREFERENCE

Ces commandes de sous-système MMEMory enregistrent et chargent les configurations de l'instrument (fichiers de configuration) ainsi que les réglages préférés pour les paramètres non volatiles (fichiers de préférences). En règle générale, les fichiers de configuration enregistrent les paramètres volatiles associés aux mesures. Les préférences sont des paramètres non volatiles associés à l'instrument, mais à aucune mesure spécifique. Le tableau suivant récapitule les informations contenues dans chaque fichier.

Fichier de configuration	Fichier de préférences
<p>Les fichiers de configuration des modèles 34460A/61A/65A/70A contiennent les informations suivantes :</p> <p>Fonction de mesure active</p> <p>Plages</p> <p>Résolution/temps intégration (NPLC)</p> <p>Commutation automatique de plage</p> <p>Réglage automatique du zéro</p> <p>Impédance auto (entrée Z)</p> <p>Bande passante de courant alternatif</p> <p>Paramètres d'échantillon et de déclenchement</p> <p>Paramètres mathématiques (activations, valeur(s) de référence, limites, ...)</p> <p>Seuil des données pour bit d'état</p> <p>Pente VM Comp (Voltmeter Complete)</p> <p>Unités de température</p> <p>Répertoire du système de fichiers par défaut</p> <p>Sélection et paramètres de l'affichage (numérique, mètre, histogramme, diagramme de tendance, ...)</p> <p>Masquage des chiffres du panneau avant numérique</p> <p>Résistance de référence DBM</p> <p>Les fichiers de configuration des modèles 34465A/70A contiennent les informations suivantes :</p> <p>Format de données binaires/ASCII et ordre des octets</p> <p>Paramètres d'affichage du diagramme de tendance et de l'histogramme</p> <p>Paramètres des modes Enregistrement de données et Numérisation</p> <p>Paramètres de la sonde de température</p> <p>Réglage du décalage de la jonction de référence à thermocouple</p>	<p>Les fichiers de préférences des modèles 34460A/61A/65A/70A contiennent les informations suivantes :</p> <p>Activations, adresses, paramètres E/S ; paramètres mDNS</p> <p>Luminosité de l'écran</p> <p>Activation de l'écran de veille, luminosité</p> <p>Séparateur numérique (virgule, espace, aucun) et symbole décimal</p> <p>Activation de l'avertisseur sonore et du clic de touche</p> <p>Langue de l'aide</p> <p>Activation de l'effacement d'état à la mise sous tension, activations d'état, filtres de transition</p> <p>État à la mise sous tension (*RST, valeurs définies par l'utilisateur, dernières valeurs utilisées)</p> <p>ID SCPI (chaîne renvoyée par *IDN)</p> <p>Message à la mise sous tension</p> <p>Modèle de couleurs (A/B)</p> <p>Activation de libellé, texte</p> <p>Les fichiers de préférences des modèles 34465A/70A contiennent les informations suivantes :</p> <p>Paramètres du format de fichier du mode Enregistrement de données</p> <p>Réglage du décalage de la jonction de référence à thermocouple</p>

Le sous-système MMEMory inclut également deux autres types de commandes :

Gestion de fichiers de base

Transfert de données

Récapitulatif des commandes

MMEMory:LOAD:PREferences

MMEMory:STORe:PREFerences

MMEMory:LOAD:STATe

MMEMory:STORe:STATe

MMEMory:STATe:RECall:AUTO

MMEMory:STATe:RECall:SElect

MMEMory:STATe:VALid?

Formats des dossiers et des fichiers

De nombreuses commandes MMEMory font référence à des dossiers et à des fichiers. Ces dernières présentent des structures particulières, décrites ci-dessous.

Format d'un <dossier>

- Le format d'un <dossier> est "[[<lecteur>:]<chemin>]", où <lecteur> peut être INTernal ou USB et <chemin> correspond au chemin d'accès au dossier et <spéc_fichier> désigne un sous-ensemble de fichiers.
- INTernal spécifie le système de fichiers flash interne. USB désigne un périphérique de stockage USB du panneau avant.
- Si <lecteur> est spécifié, <chemin> est interprété comme un chemin d'accès complet au dossier. Les chemins d'accès absolus commencent par « \ » ou « / » au niveau du répertoire racine <lecteur>.
- Si <lecteur> est omis <chemin> désigne le dossier spécifié par **MMEMory:CDIRectory**. Les chemins relatifs ne doivent PAS commencer par \ ou /.
- Les noms de dossiers et de fichiers ne doivent pas contenir les caractères suivants : \ / : * ? " < > |
- Le paramètre <dossier> ne doit pas contenir plus de 240 caractères.
- Le dossier spécifié doit exister et ne peut pas être marqué comme un dossier masqué ou système. L'exception est **MMEMory:MDIRectory**, qui crée un dossier. Pour la commande MMEMory:MDIRectory, tous les niveaux de dossier supérieurs au nouveau niveau doivent exister.

Format d'un <fichier>

- Le format d'un nom de fichier est "[[<lecteur>:]<chemin>]<nom_de_fichier>", où <lecteur> peut être INTernal ou USB, et <chemin> est un chemin d'accès à un dossier.
- INTernal spécifie le système de fichiers flash interne. USB désigne un périphérique de stockage USB du panneau avant.
- Si <lecteur> est spécifié, <chemin> est interprété comme un chemin d'accès complet au dossier. Les chemins d'accès absolus commencent par « \ » ou « / » au niveau du répertoire racine <lecteur>.
- Si <lecteur> est omis <chemin> désigne le dossier spécifié par **MMEMory:CDIRectory**. Les chemins relatifs ne doivent PAS commencer par \ ou /.
- Les noms de dossiers et de fichiers ne doivent pas contenir les caractères suivants : \ / : * ? " < > |
- La combinaison du nom de dossier et de fichier ne doit pas dépasser 240 caractères.

Mémoire de masse (MMEMory) et enregistrement de l'état

Les configurations enregistrées par le panneau avant sont accessibles à distance et vice-versa. Par exemple, configurez l'instrument comme vous le souhaitez et introduisez une clé USB dans le panneau avant. Entrez ensuite les commandes suivantes. Si vous n'avez pas de clé USB, modifiez "USB:\ " à "INT:\ " pour utiliser la mémoire flash interne de l'instrument.

```
MMEMory:CDIRectory "USB:\ "  
MMEMory:MDIRectory "States"  
MMEMory:STORe:STATE "USB:\States\State1"
```

Pour retourner à cet état à tout moment :

```
MMEMory:LOAD:STATE "USB:\States\State1"
```

Vous pouvez également rappeler un fichier de configuration à partir du panneau avant en appuyant sur [Utility] > Store/Recall.

MMEMory:LOAD:PREFerences <fichier>

MMEMory:STORe:PREFerences <fichier>

LOAD : Redémarre l'instrument et charge les paramètres d'E/S non volatiles et les préférences de l'utilisateur à partir d'un fichier. Le fichier spécifié ne peut pas être vide ni marqué comme un fichier masqué ou système.

STORE : Enregistre les paramètres d'E/S non volatiles et les préférences de l'utilisateur dans un fichier. Si le fichier de destination existe, il est remplacé, sauf s'il est marqué comme un fichier masqué ou système.

MISE EN GARDE Lorsque vous chargez un fichier de préférences spécifiant une adresse IP statique, vérifiez que l'opération n'attribue pas la même adresse IP à deux instruments sur votre réseau local. Sinon, des erreurs de configuration du réseau local risquent de se produire sur les deux instruments.

Paramètre	Renvoi type
Tout nom de fichier valide L'extension de fichier .prf est facultative. Si vous n'incluez pas cette extension, le microprogramme de l'instrument l'ajoute automatiquement.	(aucun)
Enregistrer les paramètres d'E/S non volatiles et les préférences de l'utilisateur actuels dans le fichier spécifié : MMEM:STOR:PREF "INT:\MyPreferences" Charger les paramètres d'E/S non volatiles et les préférences de l'utilisateur à partir du fichier spécifié : MMEM:LOAD:PREF "INT:\MyPreferences"	

- Pour une liste des informations contenues dans chaque fichier, reportez-vous au [tableau Fichier de configuration/Fichier de préférences](#).
- Le dossier spécifié doit exister et ne peut pas être marqué comme un dossier masqué ou système.

MMEMory:LOAD:STATe <nom_de_fichier>

MMEMory:STORe:STATe <nom_de_fichier>

Charge l'état d'un instrument à partir d'un fichier de configuration ou enregistre l'état actuel de l'instrument dans un fichier de configuration. Le nom de fichier inclut facultativement le nom du dossier et l'extension .sta. Si vous n'incluez pas cette extension, le microprogramme de l'instrument l'ajoute automatiquement.

Paramètre	Renvoi type
Tout nom de fichier valide	(aucun)
Enregistrer l'état actuel de l'instrument dans le fichier de configuration spécifié dans le répertoire racine du système de fichiers flash interne :	
MMEM:STOR:STAT "INT:\MySetup"	
Charger l'état de l'instrument à partir du fichier MySetup.sta enregistré par la commande précédente :	
MMEM:LOAD:STAT "INT:\MySetup.sta"	

- Pour une liste des informations contenues dans chaque fichier, reportez-vous au [tableau Fichier de configuration/Fichier de préférences](#).
- Le dossier spécifié doit exister et ne peut pas être marqué comme un dossier masqué ou système.
- Le fichier spécifié ne peut pas être vide ni marqué comme un fichier masqué ou système.
- Le fichier de configuration créé par la commande *SAV 0, appelé STATE_0.sta, est situé dans le dossier racine du système de fichiers flash interne. Il est remplacé par l'état d'extinction de l'instrument lorsque l'alimentation est rétablie.

MMEMory:STATe:RECall:AUTO {ON|1|OFF|0}
MMEMory:STATe:RECall:AUTO?

Désactive ou active le rappel automatique d'un état d'instrument enregistré spécifique à la mise sous tension. Spécifiez ON pour rappeler automatiquement le fichier de configuration à la mise hors tension (STATE_0 dans le dossier racine du système de fichiers flash interne) ou un fichier de configuration spécifié par l'utilisateur (MMEMory:STATe:RECall:SElect). Sélectionnez « OFF » pour déclencher une réinitialisation de la configuration d'usine (*RST) à la mise sous tension.

Paramètre	Renvoi type
{ON 1 OFF 0}. Valeur par défaut : ON.	0 (OFF) ou 1 (ON)
Sélectionnez l'état d'extinction qui sera utilisé à la mise sous tension. MMEM:STAT:REC:SEL "INT:\STATE_0" MMEM:STAT:REC:AUTO ON Enregistrer l'état actuel dans un fichier situé dans le répertoire racine du système de fichiers flash interne et le charger à la mise sous tension : MMEM:STOR:STAT "INT:\MyVoltMeas" MMEM:STAT:REC:SEL "INT:\MyVoltMeas" MMEM:STAT:REC:AUTO ON	

- À son départ de l'usine, l'instrument est configuré pour rappeler automatiquement le fichier d'état d'extinction lorsque l'alimentation est rétablie.
- Ce paramètre est non volatile ; il n'est pas altéré par une remise sous tension, une réinitialisation de la configuration d'usine (*RST) ou un pré réglage de l'instrument (SYSTem:PRESet).

MMEMory:STATe:RECall:SElect <fichier> MMEMory:STATe:RECall:SElect?

Sélectionne l'état de l'instrument qui sera utilisé à la mise sous tension si le mode de rappel automatique est activé (MMEMory:STATe:RECall:AUTO ON). Si le mode de rappel automatique est désactivé (MMEMory:STATe:RECall:AUTO OFF), une réinitialisation de la configuration d'usine (*RST) est déclenchée à la mise sous tension.

Paramètre	Renvoi type
Tout nom de fichier valide	"INT:\MyVoltMeas"
Sélectionnez l'état d'extinction qui sera utilisé à la mise sous tension. MMEM:STAT:REC:SEL "INT:\STATE_0" MMEM:STAT:REC:AUTO ON	
Enregistrer l'état actuel dans un fichier situé dans le répertoire racine du système de fichiers flash interne et le charger à la mise sous tension : MMEM:STOR:STAT "INT:\MyVoltMeas" MMEM:STAT:REC:SEL "INT:\MyVoltMeas" MMEM:STAT:REC:AUTO ON	

- Le dossier spécifié doit exister et ne peut pas être marqué comme un dossier masqué ou système.
- Le fichier de configuration créé par la commande *SAV 0, appelé STATE_0.sta, est situé dans le dossier racine du système de fichiers flash interne. Il est remplacé par l'état d'extinction de l'instrument lorsque l'alimentation est rétablie.
- À son départ de l'usine, l'instrument est configuré pour rappeler automatiquement le fichier d'état d'extinction lorsque l'alimentation est rétablie.
- Ce paramètre est non volatile ; il n'est pas altéré par une remise sous tension, une réinitialisation de la configuration d'usine (*RST) ou un préréglage de l'instrument (SYSTem:PRESet).

MMEMory:STATe:VALid? <fichier>

Renvoie la valeur 1 si le fichier de configuration spécifié existe et contient un fichier de configuration valide. Sinon, renvoie la valeur 0.

Paramètre	Renvoi type
Tout nom de fichier valide	1
Renvoyer l'état du fichier MyState.sta dans le dossier racine du système de fichiers flash interne : MMEM:STAT:VAL? "INT:\MyState.sta"	

- Le dossier spécifié doit exister et ne peut pas être marqué comme un dossier masqué ou système.
- Le fichier spécifié ne peut pas être vide ni marqué comme un fichier masqué ou système.
- Utilisez cette requête avant d'envoyer la commande *RCL ou MMEMory:LOAD:STATe pour déterminer si un état a été enregistré dans le fichier.

Sous-système MMEMory - Commandes de transfert de données

Ces commandes permettent de transférer des fichiers vers et hors de la mémoire de masse de l'instrument.

Le sous-système MMEMory inclut également deux autres types de commandes :

Gestion de fichiers de base

Gestion des fichiers STATE et PREFerence

Récapitulatif des commandes

MMEMory:DOWNload:DATA

MMEMory:DOWNload:FNAME

MMEMory:FORMat:READing:CSEPARATOR

MMEMory:FORMat:READing:INFORMATION

MMEMory:FORMat:READing:RLIMIT

MMEMory:STORe:DATA

MMEMory:UPLoad?

Formats des dossiers et des fichiers

De nombreuses commandes MMEMory font référence à des dossiers et à des fichiers. Ces dernières présentent des structures particulières, décrites ci-dessous.

Format d'un <dossier>

- Le format d'un <dossier> est "[[<lecteur>:]<chemin>]", où <lecteur> peut être INTernal ou USB et <chemin> correspond au chemin d'accès au dossier et <spéc_fichier> désigne un sous-ensemble de fichiers.
- INTernal spécifie le système de fichiers flash interne. USB désigne un périphérique de stockage USB du panneau avant.
- Si <lecteur> est spécifié, <chemin> est interprété comme un chemin d'accès complet au dossier. Les chemins d'accès absolus commencent par « \ » ou « / » au niveau du répertoire racine <lecteur>.
- Si <lecteur> est omis <chemin> désigne le dossier spécifié par **MMEMory:CDIRectory**. Les chemins relatifs ne doivent PAS commencer par \ ou /.
- Les noms de dossiers et de fichiers ne doivent pas contenir les caractères suivants : \ / : * ? " < > |
- Le paramètre <dossier> ne doit pas contenir plus de 240 caractères.
- Le dossier spécifié doit exister et ne peut pas être marqué comme un dossier masqué ou système. L'exception est **MMEMory:MDIRectory**, qui crée un dossier. Pour la commande MMEMory:MDIRectory, tous les niveaux de dossier supérieurs au nouveau niveau doivent exister.

Format d'un <fichier>

- Le format d'un nom de fichier est "[[<lecteur>:]<chemin>]<nom_de_fichier>", où <lecteur> peut être INTernal ou USB, et <chemin> est un chemin d'accès à un dossier.
- INTernal spécifie le système de fichiers flash interne. USB désigne un périphérique de stockage USB du panneau avant.
- Si <lecteur> est spécifié, <chemin> est interprété comme un chemin d'accès complet au dossier. Les chemins d'accès absolus commencent par « \ » ou « / » au niveau du répertoire racine <lecteur>.
- Si <lecteur> est omis <chemin> désigne le dossier spécifié par **MMEMory:CDIRectory**. Les chemins relatifs ne doivent PAS commencer par \ ou /.
- Les noms de dossiers et de fichiers ne doivent pas contenir les caractères suivants : \ / : * ? " < > |
- La combinaison du nom de dossier et de fichier ne doit pas dépasser 240 caractères.

MMEMory:DOWNload:DATA <bloc_binaire>

Télécharge des données depuis l'ordinateur hôte vers un fichier dont le nom a été spécifié par **MMEMory:DOWNload:FNAME**.

Les données contenues dans <bloc_binaire> sont écrites dans le fichier sélectionné.

REMARQUE

Toutes les données précédemment enregistrées dans le fichier sont perdues lors de l'exécution de cette commande.

Paramètre	Renvoi type
Tout bloc IEEE-488.2 de longueur définie ou indéfinie	(aucun)
Écrivez le mot « Hello » dans le fichier « \Myfile » de la mémoire interne.	
MMEM:DOWN:FNAME "INT:\Myfile"	
MMEM:DOWN:DATA #15Hello	

MMEMory:DOWNload:FNAME <nom_de_fichier>

MMEMory:DOWNload:FNAME?

Crée ou ouvre le nom de fichier spécifié avant d'y écrire des données avec la commande **MMEMory:DOWNload:DATA**.

Paramètre	Renvoi type
Tout nom de fichier valide	(aucun)
Écrivez le mot « Hello » dans le fichier « \Myfile » de la mémoire interne.	
MMEM:DOWN:FNAME "INT:\Myfile"	
MMEM:DOWN:DATA #15Hello	

- Le dossier spécifié doit exister et ne peut pas être marqué comme un dossier masqué ou système.
- Si le fichier de destination existe, il est remplacé, sauf s'il est marqué comme un fichier masqué ou système.
- Le fichier est créé s'il n'existe pas déjà.

MMEMory:FORMat:READIng:CSEPARATOR {COMMA|SEMICOLON|TAB}

MMEMory:FORMat:READIng:CSEPARATOR?

Spécifie le caractère utilisé pour séparer les colonnes dans les données stockées.

Paramètre	Renvoi type
{COMMA SEMICOLON TAB}. Valeur par défaut : COMMA.	TAB, COMM or SEM
Spécifier des onglets comme séparateur de colonnes :	
MMEMory:FORMat:READIng:CSEPARATOR TAB	

- Concerne uniquement les modèles 34465A et 34470A.
- Affecte le format du fichier .csv créé par la commande **MMEMory:STORe:DATA** ou par les fonctions d'enregistrement/numérisation des données des modèles 34465A/34470A.

MMEMory:FORMat:READIng:INFormation {OFF|ON}**MMEMory:FORMat:READIng:INFormation?**

Désactive/active les informations d'en-tête et les numéros de lecture dans les données stockées.

Paramètre	Renvoi type
{OFF ON}. OFF par défaut.	OFF ou ON
Activer le format du fichier .csv :	
MMEM:FORMat:READIng:INFormation ON	

- Concerne uniquement les modèles 34465A et 34470A.
- Le format du fichier .csv créé par la commande (**MMEMory:STORe:DATA**) ou par les fonctions d'enregistrement de données/numérisation des modèles 34465A/34470A est affecté comme suit :
 - OFF** = une lecture par ligne, aucune autre information d'en-tête ou de lecture.
 - ON** = active un en-tête de fichier et les numéros de lecture. L'en-tête de fichier contient la date et l'heure de début de la première lecture et, si la source d'échantillonnage est un temporisateur (SAMPle:SOURce:TIMER), l'intervalle d'échantillonnage. Chaque ligne de données inclut un numéro de mesure et la mesure.
- Affecte le fichier (binaire) .dat créé par la commande **MMEMory:STORe:DATA** comme suit :
 - OFF** = une lecture par ligne, aucune autre information d'en-tête ou de lecture.
 - ON** = une ligne d'horodatage contenant huit entiers 16 bits pour les éléments suivants : année, mois, jour de la semaine, jour, heure, minute et millisecondes. Nombre de lecture entier 32 bits et lecture IEEE-754 64 bits.

MMEMory:FORMat:READIng:RLIMit {OFF|ON}**MMEMory:FORMat:READIng:RLIMit?**

Lorsque ce paramètre est activé, limite le nombre maximal de lignes par fichier de données .csv stocké à un million, notamment toute ligne d'en-tête, si celle-ci est activée.

Paramètre	Renvoi type
{OFF ON}. ON par défaut	OFF ou ON
Désactiver les limites de ligne pour le fichier .csv :	
MMEM:FORM:READ:RLIMit OFF	

- Concerne uniquement les modèles 34465A et 34470A.
- Affecte le format du fichier .csv créé par la commande **MMEMory:STORe:DATA** ou par les fonctions d'enregistrement/numérisation des données des modèles 34465A/34470A.
- Cette fonction vous permet de prendre en charge des applications d'analyse de feuilles de calcul, de bases de données et de données communes limitées à 1 million de lignes par fichier.

Référence de programmation SCPI

- ON : les mesures sont stockées dans des fichiers nommés dat00001.csv, dat00002.csv, dat00003.csv ...
- OFF : les mesures sont stockées dans un fichier unique appelé dat00001.csv. La taille de fichier est limitée à $2^{32} = 4.294967296$ Go (la valeur maximale autorisée par le système de fichiers FAT32).

MMEMory:STOR:DATA RDG_STORE, <fichier>

Enregistre toutes les mesures de la mémoire de mesures dans le fichier de données spécifié. Le nom de fichier inclut éventuellement le nom du dossier et l'extension de fichier .csv ou .dat.

Paramètre	Renvoi type
Tout nom de fichier valide	(aucun)
Enregistre toutes les mesures de la mémoire de mesures dans le fichier MyVoltMeas.csv, situé dans le répertoire racine du système de fichiers flash interne. MMEM:STOR:DATA RDG_STORE,"INT:\MyVoltMeas"	

- Si une extension de fichier .csv est spécifiée, ou si aucune extension de fichier n'est spécifiée, les données sont stockées au format ASCII. Si l'extension de fichier .dat est spécifiée, les données sont stockées au format binaire.
- Le format du fichier est affecté par les commandes **MMEMory:FORMat:READIng:CSEParator**, **MMEMory:FORMat:READIng:INFormation** et **MMEMory:FORMat:READIng:RLIMit**.
- Le dossier de destination doit exister et ne peut pas être marqué comme un dossier masqué ou système.
- Si le fichier de destination existe, il est remplacé, sauf s'il est marqué comme un fichier masqué ou système.

MMEMory:UPLoad? <nom_de_fichier>

Télécharge le contenu d'un fichier de l'instrument vers l'ordinateur hôte.

Paramètre	Renvoi type
Tout nom de fichier valide	Bloc IEEE 488.2 de longueur définie
Télécharger le fichier de configuration « Myfile.sta » situé dans le répertoire racine du système de fichiers flash interne vers l'ordinateur hôte : MMEM:UPL? "INT:\Myfile.sta"	

Sous-système SAMPlE

Les commandes SAMPlE sont utilisées en association avec les commandes TRIGger pour configurer les paramètres de déclenchement. Utilisez les commandes SAMPlE pour configurer un nombre d'échantillons, une source d'échantillonnage et un temps de retard pour l'échantillonnage déclenché.

REMARQUE

Il est recommandé d'effectuer toutes les mesures déclenchées en utilisant une plage manuelle fixe appropriée. Aussi, désactivez la fonction de commutation automatique (**SENSe:<fonction>:RANGe:AUTO OFF**) ou définissez une plage fixe à l'aide de la commande **SENSe:<fonction>:RANGe**, **CONFIgure** ou **MEASure**.

Récapitulatif des commandes

SAMPlE:COUNT

SAMPlE:COUNT:PRETrigger

SAMPlE:SOURce

SAMPlE:TIMer

SAMPlE:COUNT {<nombre>|MIN|MAX|DEF}

SAMPlE:COUNT? [{MIN|MAX|DEF}]

Indique le nombre de mesures (échantillons) que l'instrument relève par déclenchement.

Paramètre	Renvoi type
1 à 1,000,000 (1x10 ⁶). Valeur par défaut : 1. (34460A/61A) 1 à 1 000 000 000 (1x10 ⁹). Valeur par défaut : 1. (34465A/70A)	+1
Renvoyer dix jeux de mesures de résistance en 4 fils à l'aide d'un déclenchement externe pour lancer chaque jeu de mesures : CONF:RES 1E6 SAMP:COUN 4 TRIG:COUN 10 TRIG:SOUR EXT;SLOP NEG READ? Réponse type : +1.00520000E+06, ... (40 mesures)	

- L'indicateur d'échantillons du panneau avant (« * ») est activé à chaque mesure effectuée à des vitesses plus lentes. L'indicateur est activé/désactivé à une vitesse fixe pour les mesures rapides.
- Vous pouvez utiliser le nombre d'échantillons spécifiés conjointement avec un nombre de déclenchements (**TRIGger:COUNT**), qui définit le nombre de déclenchements à accepter avant de renvoyer l'état de déclenchement « inactif ». Le nombre total de mesures renvoyées correspond au produit du nombre d'échantillons et du nombre de déclenchements.

Référence de programmation SCPI

- Vous pouvez stocker jusqu'à 1 000 mesures dans la mémoire de mesures du modèle 34460A, 10 000 mesures dans celle du modèle 34461A, 50 000 mesures sur le modèle 34465A/70A (sans l'option MEM) ou 2 000 000 mesures sur le modèle 34465A/70A (avec l'option MEM). Si la mémoire de mesures est saturée, les nouvelles mesures remplacent les anciennes mesures enregistrées ; les mesures les plus récentes sont toujours conservées. Aucune erreur n'est générée. Toutefois, le bit Reading Mem Ovfl (bit 14) est défini dans le registre de conditions du registre des données douteuses (voir la section [Présentation du système d'état](#)).
- MAX sélectionne 1 milliard de lectures. Cependant, lorsque le pré-déclenchement est sélectionné, la valeur maximale est de 50 000 lectures (sans l'option MEM) ou de 2 000 000 lectures (avec l'option MEM).
- Ce paramètre est défini à sa valeur par défaut après une réinitialisation de la configuration d'usine (*RST) ou un préreglage de l'instrument (SYSTem:PRESet).

SAMPlE:COUNT:PRETrigger {<nombre>|MIN|MAX|DEF}

SAMPlE:COUNT:PRETrigger? [{MIN|MAX|DEF}]

Permet la collecte des données en cours de numérisation *avant* le déclenchement. Alloue de la mémoire aux échantillons de pré-déclenchement jusqu'au nombre d'échantillons de pré-déclenchement spécifié.

REMARQUE

Il est recommandé d'effectuer toutes les mesures déclenchées en utilisant une plage manuelle fixe appropriée. Aussi, désactivez la fonction de commutation automatique (**SENSe:<function>:RANGe:AUTO OFF**) ou définissez une plage fixe à l'aide de la commande **SENSe:<function>:RANGe**, **CONFigure** ou **MEASure**.

Paramètre	Renvoi type
0 à 1 999 999. Valeur par défaut : 0.	+999999
<p>Configurez les mesures en tension alternative avec la plage de 100 V. Définissez le nombre d'échantillons à 10 000 et le nombre d'échantillons de pré-déclenchement à 5 000 (5 000 échantillons sont prélevés avant le déclenchement, et 5 000 après le déclenchement). Le déclenchement se produit lorsque le signal d'entrée atteint 0,75 volts.</p> <pre> CONF:VOLT:AC VOLT:AC:RANG 100 SAMP:COUN 10000 SAMP:COUN:PRET 5000 TRIG:SOUR INT TRIG:LEV 0.75 INIT </pre>	

- Concerne uniquement les modèles 34465A et 34470A.
- Le pré-déclenchement s'applique à toutes les fonctions de mesure, à l'exception du test CONTinuity et DIODE.

- Utilisez la commande **SAMPlE:COUNT** pour définir le nombre *total* d'échantillons à prélever, puis utilisez la commande **SAMPlE:COUNT:PRETrigger** pour définir le nombre d'échantillons de pré-déclenchement à prélever.

Par exemple, avec 50 000 échantillons et 20 000 échantillons de pré-déclenchement, jusqu'à 20 000 échantillons sont prélevés avant le déclenchement, et 30 000 échantillons sont ensuite prélevés après le déclenchement).

Le nombre d'échantillons et le nombre de pré-déclenchements ne changent pas lorsque le déclenchement se produit. Si la mémoire allouée aux échantillons de pré-déclenchement est saturée, les lectures les plus anciennes sont ignorées. Dans l'exemple ci-dessus, les 20 000 échantillons de pré-déclenchement *les plus récents* sont enregistrés, même si plus de 20 000 échantillons sont acquis avant le déclenchement. Si le déclenchement se produit *avant* que le nombre de pré-déclenchements soit obtenu, seuls les échantillons de pré-déclenchement réels qui ont été acquis sont sauvegardés.

Dans tous les cas, une fois le déclenchement reçu, seules les lectures du *nombre d'échantillons* moins les lectures du *nombre de pré-déclenchements spécifié* sont relevées. Dans cet exemple, si le déclenchement se produit après avoir acquis 5 échantillons de pré-déclenchement (au lieu des 20 000 spécifiés), seuls 30 000 échantillons de post-déclenchement sont acquis. Cela est dû au fait que de la mémoire a été réservée à 20 000 échantillons de pré-déclenchement.

- Si un déclenchement se produit pendant une mesure, cette dernière est considérée comme un échantillon de pré-déclenchement.
- Après avoir défini le nombre d'échantillons et le nombre d'échantillons de pré-déclenchement, vous devez placer l'instrument à l'état « en attente de déclenchement » à l'aide de la commande **INITiate** ou **READ?**. Un déclenchement externe est mis en mémoire tampon jusqu'à ce que le multimètre numérique est à l'état « en attente de déclenchement ».
- Le nombre d'échantillons de pré-déclenchement doit être inférieur au nombre d'échantillons défini avec la commande **SAMPlE:COUNT**, et au moins un échantillon de post-déclenchement doit exister :

$$\text{Nombre d'échantillons de pré-déclenchement} \leq \text{Nombre d'échantillons} - 1.$$

- Si l'une des fonctions de calcul est activée (**CALC:STAT ON**), le nombre de pré-déclenchements est limité à 10 000 échantillons.
- Les commandes **CONFigure** et **MEASure** définissent le nombre d'échantillons de pré-déclenchement à 0.
- L'instrument définit la valeur de décalage à 0 après une réinitialisation de la configuration d'usine (commande ***RST**) ou un pré-réglage de l'instrument (commande **SYSTEM:PRESet**).

Voir également

SAMPlE:COUNT

SAMPlE:SOURce {IMMediate|TIMer}

SAMPlE:SOURce?

Détermine la fréquence d'échantillonnage avec les commandes **TRIGger:DELay** et **SAMPlE:TIMer** lorsque le nombre d'échantillons est supérieur à 1.

REMARQUE

Il est recommandé d'effectuer toutes les mesures déclenchées en utilisant une plage manuelle fixe appropriée. Aussi, désactivez la fonction de commutation automatique (**SENSe:<function>:RANGe:AUTO OFF**) ou définissez une plage fixe à l'aide de la commande **SENSe:<function>:RANGe**, **CONFIgure** ou **MEASure**.

Paramètre	Renvoi type
{IMMediate TIMer}. Valeur par défaut : IMMediate.	IMM ou TIM
Définissez le temporisateur comme source d'échantillonnage. La commande INIT définit le multimètre à l'état « en attente de déclenchement ». Lorsqu'un déclenchement est reçu depuis la source de déclenchement sélectionnée, l'instrument commence par prélever des échantillons périodiques après le délai de déclenchement. SAMP:SOUR TIM SAMP:TIM 0.1 INIT	

Utilisation

Dans tous les cas, le premier échantillon est prélevé avec un temps de retard après le déclenchement (le délai défini avec la commande **TRIGger:DELay**). Passé ce délai, le mécanisme d'échantillonnage varie selon que vous sélectionnez la source **IMMediate** (par défaut) ou **TIMer** :

- **IMMediate** - Le premier échantillon commence avec un temps de retard après le déclenchement, puis le retard de déclenchement est inséré entre les premiers et deuxième échantillons, entre le deuxième et le troisième, etc. :

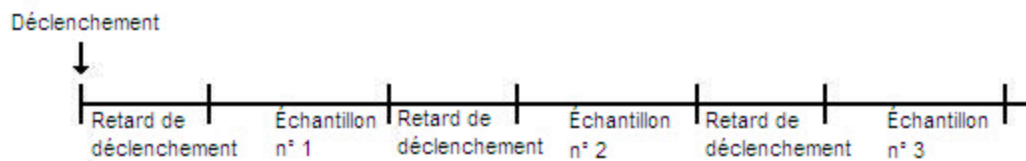

La fréquence d'échantillonnage n'est pas déterminante, car le temps de retard (défini avec la commande **TRIGger:DELay**) est inséré à la fin de chaque échantillonnage. La durée réelle nécessaire pour mesurer chaque échantillon varie selon le temps d'intégration et le temps de commutation automatique. Dans ce cas, la commande **SAMPlE:TIMer** n'a aucun effet.

- **TIMer** - Le premier échantillon commence avec un temps de retard après le déclenchement. Cependant, le deuxième échantillon commence à l'intervalle d'échantillonnage suivant le début du premier échantillon, etc. :

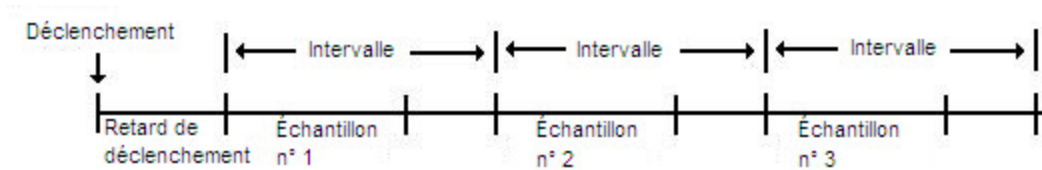

La fréquence d'échantillonnage est déterminante, car le début de chaque échantillon est déterminé par l'intervalle d'échantillonnage, défini avec la commande `SAMPlE:TiMer` (la commande `TRIGger:DELaY` affecte uniquement le début du premier échantillon). Le temps d'intégration et la commutation automatique de plage ont une incidence sur le temps d'échantillonnage de chaque échantillon, mais pas sur l'intervalle d'échantillonnage, dès lors que l'intervalle d'échantillonnage est plus long que la durée d'échantillonnage.

Remarques

- Concerne uniquement les modèles 34465A et 34470A.
- Cette commande n'a aucun effet si le nombre d'échantillons est 1 (voir `SAMPlE:COUnT`).
- Après avoir défini le nombre d'échantillons, la source d'échantillonnage et l'intervalle d'échantillonnage ou le retard de déclenchement, vous devez placer l'instrument à l'état « en attente de déclenchement » à l'aide de la commande `INITiate` ou `READ?`. Un déclenchement n'est accepté par la source de déclenchement sélectionnée (voir la commande `TRIGger:SOURce`) que si l'instrument est à l'état « en attente de déclenchement ».
- L'instrument définit la valeur de décalage à 0 après une réinitialisation de la configuration d'usine (commande `*RST`) ou un pré réglage de l'instrument (commande `SYSTem:PRESet`).

Voir également

`TRIGger:COUnT`

`TRIGger:DELaY`

`TRIGger:SOURce`

`SAMPlE:COUnT`

`SAMPlE:TiMer`

`SAMPlE:TiMer {<intervalle>|MIN|MAX|DEF}`

`SAMPlE:TiMer? [{MIN|MAX|DEF}]`

Définit la fréquence d'échantillonnage pour l'échantillonnage temporisé (`SAMPlE:SOURce TiMer`) lorsque le nombre d'échantillons est supérieur à 1.

Le premier échantillon est prélevé avec un temps de retard après le déclenchement (le retard actuellement défini avec la commande `TRIGger:DELaY`). Le deuxième échantillon commence à l'intervalle d'échantillonnage suivant le début du premier échantillon, etc., comme indiqué ci-dessous :

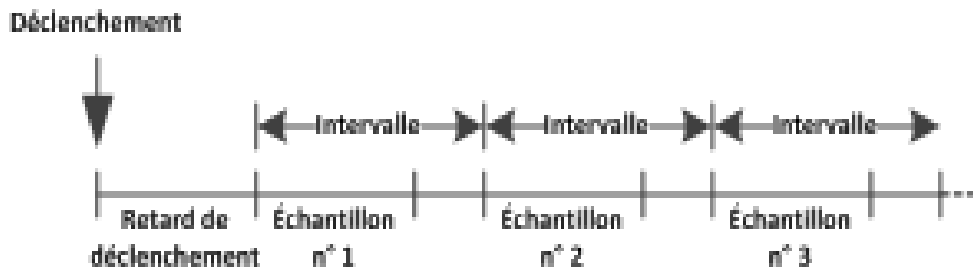

Notez que la fréquence d'échantillonnage est déterminante, car le début de chaque échantillon est déterminé par l'intervalle d'échantillonnage. Le temps d'intégration et la commutation automatique de plage ont une incidence sur le temps d'échantillonnage de chaque échantillon, mais pas sur l'intervalle d'échantillonnage, dès lors que l'intervalle d'échantillonnage est plus long que la durée d'échantillonnage. L'échantillonnage périodique se poursuit jusqu'à ce que le nombre d'échantillons désiré (réglé avec la commande **SAMPle:COUNT**) soit obtenu.

REMARQUE

Il est recommandé d'effectuer toutes les mesures déclenchées en utilisant une plage manuelle fixe appropriée. Aussi, désactivez la fonction de commutation automatique (**SENSe:<fonction>:RANGe:AUTO OFF**) ou définissez une plage fixe à l'aide de la commande **SENSe:<fonction>:RANGe, CONFigure** ou **MEASure**. Lorsque la fonction de commutation automatique de plage demeure activée, la fréquence d'échantillonnage d'un échantillon devient incertaine (lorsqu'un changement de plage se produit) et lorsque la commutation de plage dépasse l'intervalle entre les échantillons ; tous les échantillons ultérieurs sont décalés par rapport à leurs points de début désirés.

Paramètre	Renvoi type
<intervalle> MIN (voir les points d'énumération ci-dessous), à 3 600 secondes (pas de ~1 µs).	+3.60000000E+003
Définissez l'intervalle d'échantillonnage à 0,1 seconde. La commande INIT définit le multimètre à l'état « en attente de déclenchement ». Lorsqu'un déclenchement est reçu depuis la source de déclenchement sélectionnée, l'instrument attend jusqu'à la fin du délai de déclenchement, puis prélève des mesures toutes les 0,10 seconde jusqu'à l'obtention du nombre d'échantillons. SAMP:SOUR TIM SAMP:TIM 0.1 INIT	

- La valeur de MIN dépend de la mesure. Elle varie en fonction de certains éléments, tels que le temps d'intégration, l'activation ou la désactivation du réglage automatique du zéro, de la commutation automatique de plage et de la plage de mesure. En règle générale, la valeur MIN est automatiquement déterminée de sorte que l'intervalle d'échantillonnage est toujours supérieur à la durée d'échantillonnage (voir l'illustration ci-dessus). Exécutez **SAMPle:TIMer? MIN** pour déterminer l'intervalle recommandé pour la configuration de mesure actuelle.
- Étant donné que la valeur minimale change selon la configuration, il existe une dépendance vis-à-vis de l'ordre des commandes. Vous devez configurer entièrement la mesure avant de définir le temporisateur d'échantillonnage sur MIN, sous peine de générer une erreur. Une configuration complète inclut des éléments, tels que les statistiques mathématiques ou le réglage d'échelle.

- Lors de l'utilisation de la commutation automatique de plage, la valeur MIN est la valeur *recommandée* et non la valeur *absolue minimale*. Lorsque la fonction de commutation automatique de plage est activée, la valeur MIN est calculée en supposant qu'un seul changement de plage se produit pour chaque mesure (et non plusieurs plages, montée ou descente d'une seule plage par mesure). Vous pouvez spécifier un <intervalle> entre la valeur absolue minimale (supposons qu'il n'y a aucun changement de plage) et la valeur MIN recommandée. Cependant, cela peut engendrer une violation de temporisation lors des mesures. Le choix d'une valeur inférieure à la valeur absolue minimale provoque une erreur.
- Pour déterminer la valeur absolue minimale pour la configuration actuelle, définissez la durée d'échantillonnage à 20 μs (ce qui peut générer une erreur de conflit de paramètres), puis relisez la valeur actuelle du temporisateur d'échantillonnage à l'aide de la requête `SAMP:TIMer?` La source d'échantillonnage doit être Temporisateur avec un nombre d'échantillons ou un nombre de déclenchements supérieur à 1 pour que l'erreur de conflit de paramètres se produise. L'erreur de conflit de paramètres entraîne la définition du temporisateur sur la valeur absolue minimale.
- La résolution de la durée d'échantillonnage est de 1 μs , la résolution de l'ouverture est de 2 μs et la résolution matérielle réelle n'est pas tout à fait de 1 μs . Dans certains cas, une valeur de durée d'échantillonnage arrondie à la résolution matérielle la plus proche génère une valeur inférieure à celle de l'ouverture lorsqu'elle est arrondie à 2 μs . Cela provoque l'affichage du message d'erreur suivant : `-221, "Settings conflict; cannot meet requested timing; SAMP:TIM changed"` (-221, « Conflit de paramètres ; impossible de définir la fréquence demandée ; SAMP TIM modifié »). Par exemple, la séquence de commandes suivante génère l'erreur -221 et définit la fréquence d'échantillonnage à `+2.00100000E-003`.

```
*RST
FUNC "VOLT:DC"
VOLT:DC:APER 0.002
VOLT:DC:RANGE:AUTO OFF
VOLT:DC:ZERO:AUTO OFF
TRIG:DEL 0
TRIG:SOUR BUS
SAMP:COUN 2
SAMP:TIM 0.002
SAMP:SOUR TIM
```

Cette erreur peut également se produire si vous essayez de définir les deux valeurs sur un nombre impair de μs . Par exemple, la définition des deux valeurs sur 23 μs génère l'erreur -221 et définit le temporisateur d'échantillonnage à 24 μs .

- Après avoir défini le nombre d'échantillons, la source et le retard, vous devez placer l'instrument à l'état « en attente de déclenchement » à l'aide de la commande `INITiate` ou `READ?`. Un déclenchement n'est accepté par la source de déclenchement sélectionnée (voir la commande `TRIGger:SOURce`) que si l'instrument est à l'état « en attente de déclenchement ».
- L'intervalle peut être défini sur n'importe quelle valeur, entre la valeur absolue minimale décrite ci-dessus et 3 600 secondes. Cependant, la valeur est arrondie au pas le plus proche. Pour les mesures en courant continu, la taille du pas est de 1 μs . Pour les mesures en courant alternatif, elle dépend de la bande passante de courant alternatif.

Référence de programmation SCPI

- L'instrument définit le temporisateur d'échantillonnage à 1 seconde après une réinitialisation de la configuration d'usine (commande ***RST**) ou un pré réglage de l'instrument (commande **SYSTem:PRESet**).

Voir également

TRIGger:COUNT

TRIGger:DELaY

TRIGger:SOURce

SAMPlE:COUNT

SAMPlE:SOURce

Sous-système SENSE - Présentation

Le sous-système SENSE configure des mesures. La commande SENSE de base est [SENSe:]FUNCTION[:ON], qui sélectionne la fonction de mesure. Toutes les autres commandes SENSE sont associées à des types de mesures spécifiques :

Capacité (modèles 34465A et 34470A uniquement)

Courant

Données2

Fréquence et période

Résistance à 2 et 4 fils

Température

Tension

[SENSe:]FUNCTION[:ON] "<fonction>"

[SENSe:]FUNCTION[:ON]?

Sélectionne la fonction de mesure (tous les attributs de mesure associés à la fonction sont conservés).

Paramètre	Renvoi type
CAPacitance CONTinuity CURRent:AC CURRent[:DC] DIODe FREQuency FRESistance PERiod RESistance TEMPerature VOLTage:AC VOLTage[:DC] VOLTage[:DC]:RATio La valeur par défaut est VOLTage[:DC].	La forme abrégée de la fonction sélectionnée est renvoyée entre guillemets, sans mot-clé facultatif : "CONT", "CURR:AC", "CURR", "DIOD", etc.
Sélectionner la fonction de tension alternative : FUNC "VOLT:AC"	

- Si vous changez de fonction de mesure, tous les attributs de mesure de la fonction précédente (plage, résolution, etc.) sont mémorisés. Si vous retournez à la fonction d'origine, ces attributs de mesure sont rétablis.
- Tout changement de fonction de mesure entraîne la désactivation du réglage d'échelle, des tests de limites et des statistiques (commandes CALC:SCAL:STAT, CALC:LIM:STAT, CALC:TRAN:HIST:STAT, CALC:AVER:STAT et CALC:TCH:STAT désactivées).
- Ce paramètre est défini à sa valeur par défaut après une réinitialisation de la configuration d'usine (*RST) ou un pré-réglage de l'instrument (SYSTem:PRESet).

Sous-système [SENSe:]CAPacitance

Ce sous-système configure les mesures de capacité.

Récapitulatif des commandes

[SENSe:]CAPacitance:NULL[:STATe]

[SENSe:]CAPacitance:NULL:VALue

[SENSe:]CAPacitance:NULL:VALue:AUTO

[SENSe:]CAPacitance:RANGe:AUTO

[SENSe:]CAPacitance:RANGe

[SENSe:]CAPacitance:SECondary

[SENSe:]CAPacitance:NULL[:STATe] {ON|1|OFF|0}

[SENSe:]CAPacitance:NULL[:STATe]?

Active ou désactive la fonction de mesure par rapport à une référence pour les mesures de capacité.

Paramètre	Renvoi type
{ON 1 OFF 0}. Valeur par défaut : ON.	0 (OFF) ou 1 (ON)
<p>Configurez les mesures de capacité, activez la fonction de mesure par rapport à une référence, utilisez la fonction de mesure par rapport à une référence AUTO. Effectuez deux mesures, puis envoyez-les au tampon de sortie de l'instrument :</p> <pre>CONF:CAP AUTO CAP:NULL ON CAP:NULL:VAL:AUTO ON SAMP:COUN 2 READ?</pre> <p>Réponse type : +3.01963841E-10,+3.01566277E-10</p>	

- L'activation de la fonction de réglage d'échelle entraîne également celle de la sélection automatique de la valeur de référence ([SENSe:]CAPacitance:NULL:VALue:AUTO).
- Pour définir une valeur de référence fixe, utilisez la commande suivante : [SENSe:]CAPacitance:NULL:VALue.
- L'instrument désactive la fonction de mesure par rapport à une référence après une réinitialisation de la configuration d'usine (*RST), un pré-réglage de l'instrument (SYSTem:PRESet) ou l'exécution de la fonction CONFigure.

[SENSe:]CAPacitance:NULL:VALue {<valeur>|MIN|MAX|DEF}

[SENSe:]CAPacitance:NULL:VALue? [{MIN|MAX|DEF}]

Enregistre une valeur de référence pour les mesures de capacité. La valeur de référence est soustraite de chaque échantillon si l'état Null est activé.

Paramètre	Renvoi type
<valeur> -120 à +120 µF. Valeur par défaut : 0.	-1.20000000E-04
Configurez les mesures de capacité, activez la fonction de mesure par rapport à une référence. Effectuez deux mesures, puis envoyez-les au tampon de sortie de l'instrument : CONF:CAP AUTO CAP:NULL ON CAP:NULL:VAL 1.2E-12 SAMP:COUN 2 READ? Réponse type : +3.01963841E-10,+3.01566277E-10	

- La saisie d'une valeur de référence entraîne également celle de la sélection automatique de la valeur de référence ([SENSe:]CAPacitance:NULL:VALue:AUTO OFF).
- Pour utiliser la valeur de référence, activez l'état Null à l'aide de la commande [Sen-se:]CAPacitance:NULL[:STATe].
- Ce paramètre est défini sur sa valeur par défaut après une réinitialisation de la configuration d'usine (*RST), un pré réglage de l'instrument (SYSTem:PRESet) ou l'exécution de la fonction CONFigure.

[SENSe:]CAPacitance:NULL:VALue:AUTO {ON|1|OFF|0}

[SENSe:]CAPacitance:NULL:VALue:AUTO?

Active ou désactive la sélection automatique de la valeur de référence pour toutes les mesures de capacité.

Paramètre	Renvoi type
{ON 1 OFF 0}. Valeur par défaut : ON.	0 (OFF) ou 1 (ON)
<p>Configurez les mesures de capacité, activez la fonction de mesure par rapport à une référence, utilisez la fonction de mesure par rapport à une référence AUTO. Effectuez deux mesures, puis envoyez-les au tampon de sortie de l'instrument :</p> <p>CONF:CAP AUTO CAP:NULL ON CAP:NULL:VAL:AUTO ON SAMP:COUN 2 READ?</p> <p>Réponse type : +3.01963841E-10,+3.01566277E-10</p>	

- Lorsque la sélection de référence automatique est activée, la première mesure effectuée est utilisée comme valeur de référence pour toutes les mesures suivantes. La commande [SENSe:]CAPacitance:NULL:VALue est définie sur cette valeur. La sélection automatique de la valeur de référence sera désactivée.
- Lorsque la sélection automatique de la valeur de référence est désactivée (OFF), la valeur de référence est spécifiée par la commande suivante : [SENSe:]CAPacitance:NULL:VALue.
- L'instrument active la sélection automatique de la valeur de référence lorsque la fonction de mesure par rapport à une référence est activée ([SENSe:]CAPacitance:NULL:STATe ON).
- Ce paramètre est défini sur sa valeur par défaut après une réinitialisation de la configuration d'usine (*RST), un pré réglage de l'instrument (SYSTem:PRESet) ou l'exécution de la fonction CONFIGure.

[SENSe:]CAPacitance:RANGe:AUTO {OFF|ON|ONCE}

[SENSe:]CAPacitance:RANGe:AUTO?

Désactive ou active la commutation automatique de plage pour les mesures de capacité.

Paramètre	Renvoi type
{OFF ON ONCE}. Valeur par défaut : ON.	0 (OFF) ou 1 (ON)
<p>Configurez les mesures de capacité, utilisez la commutation automatique de plage, activez la fonction de mesure par rapport à une référence AUTO, utilisez la fonction de mesure par rapport à une référence AUTO. Effectuez deux mesures, puis envoyez-les au tampon de sortie de l'instrument :</p> <p>CONF:CAP CAP:RANG:AUTO ON CAP:NULL ON CAP:NULL:VAL:AUTO ON SAMP:COUN 2 READ?</p> <p>Réponse type : +3.01963841E-10,+3.01566277E-10</p>	

- La commutation automatique de plage descend d'une plage à moins de 10 % de la plage et augmente d'une plage à plus de 120 % de la plage. Pour les mesures de capacité uniquement, lorsque la fonction de commutation automatique de plage est désactivée, l'instrument ne signale pas de surcharge pour les lectures supérieures à 120 % de la plage. Une surcharge se produit uniquement une fois le délai de l'algorithme dépassé car la capacité appliquée est trop élevée pour l'algorithme à mesurer. Si vous appliquez une tension continue ou un court-circuit aux bornes d'entrée en mode de mesure de capacité, l'instrument rapporte une surcharge.
- L'indication de la commande ONCE entraîne immédiatement la commutation automatique de plage, puis la désactivation de la commutation automatique. (Ainsi, la requête renvoie la valeur « 0 ».)
- La sélection d'une plage fixe (voir la commande [Sense:]CAPacitance:RANGe) entraîne la désactivation de la commutation automatique de plage.
- Ce paramètre est défini à sa valeur par défaut après une réinitialisation de la configuration d'usine (*RST) ou un préreglage de l'instrument (SYSTem:PRESet).

[SENSe:]CAPacitance:RANGe {<plage>|MIN|MAX|DEF}

[SENSe:]CAPacitance:RANGe? [{MIN|MAX|DEF}]

Sélectionne une plage de mesure fixe pour les mesures de capacité.

Paramètre	Renvoi type
<plage> : {1 nF 10 nF 100 nF 1 µF 10 µF 100 µF}. Valeur par défaut : AUTO.	+1.00000000E-09
<p>Configurez les mesures de capacité, sélectionnez la plage 1 nF, activez la fonction de mesure par rapport à une référence, utilisez la fonction de mesure par rapport à une référence AUTO. Effectuez deux mesures, puis envoyez-les au tampon de sortie de l'instrument :</p> <pre>CONF:CAP CAP:RANG 1 nF ou CAP:RANG 1.0E-9 CAP:NULL ON CAP:NULL:VAL:AUTO ON SAMP:COUN 2 READ?</pre> <p>Réponse type : +3.01963841E-10,+3.01566277E-10</p>	

- La sélection d'une plage fixe ([SENSe:]<fonction>:RANGe) entraîne la désactivation de la commutation automatique de plage.
- Si le signal d'entrée est supérieur au signal pouvant être mesuré dans la plage manuelle spécifiée, l'instrument affiche le terme *Overload* sur le panneau avant et renvoie « 9.9E37 » depuis l'interface de commande à distance.
- Ce paramètre est défini à sa valeur par défaut après une réinitialisation de la configuration d'usine (*RST) ou un préreglage de l'instrument (SYSTem:PRESet).

[SENSe:]CAPacitance:SEConDary {"OFF"|"CALCulate:DATA"}
 [SENSe:]CAPacitance:SEConDary?

Sélectionne la fonction de mesure secondaire pour les mesures de capacité.

Paramètre	Renvoi type
{"OFF" "CALCulate:DATA"}, "OFF" par défaut	"CALC:DATA"
Configurez les mesures de capacité et secondaires. Effectuez une mesure de capacité et récupérez la mesure secondaire. CONF:CAP AUTO,MAX CAP:SEC "CALC:DATA" READ?;DATA2? Réponse type : +3.01566373E-10;+3.01566373E-10	

- "CALCulate:DATA" - Valeur de mesure avant que toute opération mathématique ne soit effectuée (notamment l'opération NULL).
- Utilisez la commande **READ?** ou **INITiate** pour lancer la mesure. Utilisez la commande **[SENSe:]DATA2?** pour récupérer la mesure secondaire.
- Ce paramètre est défini à sa valeur par défaut après une réinitialisation de la configuration d'usine (***RST**) ou un préreglage de l'instrument (**SYSTem:PRESet**).

Sous-système [SENSe:]CURRent

Ce sous-système configure les mesures en courant alternatif et en courant continu.

Récapitulatif des commandes

[SENSe:]CURRent:AC:BANDwidth

[SENSe:]CURRent:{AC|DC}:NULL[:STATe]

[SENSe:]CURRent:{AC|DC}:NULL:VALue

[SENSe:]CURRent:{AC|DC}:NULL:VALue:AUTO

[SENSe:]CURRent:{AC|DC}:RANGe

[SENSe:]CURRent:{AC|DC}:RANGe:AUTO

[SENSe:]CURRent:{AC|DC}:TERMinals

[SENSe:]CURRent:AC:SECOndary

[SENSe:]CURRent[:DC]:APERture

[SENSe:]CURRent[:DC]:APERture:ENABled

[SENSe:]CURRent[:DC]:NPLC

[SENSe:]CURRent[:DC]:RESolution

[SENSe:]CURRent[:DC]:SECOndary

[SENSe:]CURRent[:DC]:ZERO:AUTO

[SENSe:]CURRent:SWITCh:MODE

[SENSe:]CURRent:AC:BANDwidth {<filtre>|MIN|MAX|DEF}
 [SENSe:]CURRent:AC:BANDwidth? [{MIN|MAX|DEF}]

Définit la bande passante pour les mesures en courant alternatif.

L'instrument utilise trois filtres de courant alternatif différents qui vous permettent d'optimiser la précision en basse fréquence ou de réduire les temps de stabilisation en courant alternatif suite à une variation de l'amplitude du signal d'entrée.

REMARQUE Sur les modèles 34461A, 34465A ou 34470A, utilisez la commande [SENSe:]CURRent:{AC|DC}:TERMi-nals pour spécifier les bornes de courant à utiliser pour la mesure.

Paramètre	Renvoi type
{3 Hz 20 Hz 200 Hz}. Valeur par défaut : 20 Hz.	+2.00000000E+01
Effectuez et lisez une mesure en courant alternatif. Utilisez la bande passante de filtre 3 Hz :	
CONF:CURR:AC 1 CURR:AC:BAND 3 READ?	
Réponse type : +5.23918293E+00	

- Si vous saisissez la fréquence la plus basse attendue, la commande sélectionnera le <filtre> approprié. Par exemple, si vous saisissez 15 Hz, le filtre lent (3 Hz) est sélectionné. Si vous saisissez 190 Hz, le filtre moyen (20 Hz) est sélectionné pour fournir la fréquence de coupure basse appropriée.
- Définissez la fréquence la plus basse que vous espérez trouver. Les bandes passantes inférieures produisent des délais de stabilisation plus longs, comme indiqué ci-dessous :

Fréquence d'entrée	Délai de stabilisation par défaut
3 Hz - 300 kHz (<i>lent</i>)	1,66 s/mesure
20 Hz - 300 kHz (<i>moyen</i>)	0,25 s/mesure
200 Hz - 300 kHz (<i>rapide</i>)	0,025 s/mesure

- Ce paramètre est défini à sa valeur par défaut après une réinitialisation de la configuration d'usine (*RST) ou un préreglage de l'instrument (SYSTem:PRESet).

[SENSe:]CURRent:{AC|DC}:NULL[:STATe] {ON|1|OFF|0}
 [SENSe:]CURRent:{AC|DC}:NULL[:STATe]?

Active ou désactive la fonction de mesure par rapport à une valeur de référence pour les mesures en courant alternatif ou en courant continu.

REMARQUE Ce paramètre n'est pas commun aux mesures en courant alternatif et courant continu. Les paramètres sont distincts pour les mesures en courant alternatif et courant continu.

REMARQUE Sur les modèles 34461A, 34465A ou 34470A, utilisez la commande [SENSe:]CURRent:{AC|DC}:TERMi-nals pour spécifier les bornes de courant à utiliser pour la mesure.

Paramètre	Renvoi type
{ON 1 OFF 0}. Valeur par défaut : OFF.	0 (OFF) ou 1 (ON)
Configurez les mesures en tension alternative à l'aide de la fonction de mesure par rapport à une référence pour soustraire 100 mA des mesures. Effectuez ensuite deux mesures et envoyez-les au tampon de sortie de l'instrument : CONF:CURR:AC CURR:AC:NULL:STAT ON;VAL 100 mA SAMP:COUN 2 READ? Réponse type : +1.04530000E+00,+1.04570000E+00	

- L'activation de la fonction de réglage d'échelle entraîne également celle de la sélection automatique de la valeur de référence ([SENSe:]CURRent:{AC|DC}:NULL:VALue:AUTO ON).
- Pour définir une valeur de référence fixe, utilisez la commande suivante : [SENSe:]CURRent:{AC|DC}:NULL:VALue.
- L'instrument désactive la fonction de mesure par rapport à une référence après une réinitialisation de la configuration d'usine (*RST), un pré-réglage de l'instrument (SYSTem:PRESet) ou l'exécution de la fonction CONFIGure.

[SENSe:]CURRent:{AC|DC}:NULL:VALue {<valeur>|MIN|MAX|DEF}

[SENSe:]CURRent:{AC|DC}:NULL:VALue? [{MIN|MAX|DEF}]

Définit la valeur de référence pour les mesures en courant alternatif ou en courant continu.

REMARQUE Ce paramètre n'est pas commun aux mesures en courant alternatif et courant continu. Les paramètres sont distincts pour les mesures en courant alternatif et courant continu.

REMARQUE Sur les modèles 34461A, 34465A ou 34470A, utilisez la commande **[SENSe:]CURRent:{AC|DC}:TERMi-nals** pour spécifier les bornes de courant à utiliser pour la mesure.

Paramètre	Renvoi type
-12 à 12 A, Valeur par défaut : 0	+1.04530000E+00
<p>Configurez les mesures en tension alternative à l'aide de la fonction de mesure par rapport à une référence pour soustraire 100 mA des mesures. Effectuez ensuite deux mesures et envoyez-les au tampon de sortie de l'instrument :</p> <pre>CONF:CURR:AC CURR:AC:NULL:STAT ON;VAL 100 mA SAMP:COUN 2 READ?</pre> <p>Réponse type : +1.04530000E+00,+1.04570000E+00</p>	

- La saisie d'une valeur de référence entraîne la désactivation de la sélection automatique de la valeur de référence (**[SENSe:]CURRent:{AC|DC}:NULL:VALue:AUTO OFF**).
- Pour utiliser la valeur de référence, l'état Null doit être activé (**[SENSe:]CURRent:{AC|DC}:NULL:STATe ON**).
- Ce paramètre est défini sur sa valeur par défaut après une réinitialisation de la configuration d'usine (***RST**), un pré réglage de l'instrument (**SYSTem:PRESet**) ou l'exécution de la fonction **CONFigure**.

[SENSe:]CURRent:{AC|DC}:NULL:VALue:AUTO {ON|1|OFF|0}
[SENSe:]CURRent:{AC|DC}:NULL:VALue:AUTO?

Active ou désactive la sélection automatique de la valeur de référence pour les mesures en courant alternatif ou en courant continu.

REMARQUE Ce paramètre n'est pas commun aux mesures en courant alternatif et courant continu. Les paramètres sont distincts pour les mesures en courant alternatif et courant continu.

REMARQUE Sur les modèles 34461A, 34465A ou 34470A, utilisez la commande **[SENSe:]CURRent:{AC|DC}:TERMi-nals** pour spécifier les bornes de courant à utiliser pour la mesure.

Paramètre	Renvoi type
{ON 1 OFF 0}. Valeur par défaut : ON.	0 (OFF) ou 1 (ON)
Configurez les mesures en tension alternative à l'aide de la fonction de mesure par rapport à une référence pour soustraire 100 mA des mesures. Effectuez ensuite deux mesures et envoyez-les au tampon de sortie de l'instrument : CONF:CURR:AC CURR:AC:NULL:STAT ON;VAL 100 mA SAMP:COUN 2 READ? Réponse type : +1.04530000E+00,+1.04570000E+00 Effectuer un deuxième jeu de mesures à l'aide de la fonction de sélection automatique de la valeur de référence : CURR:AC:NULL:VAL:AUTO ON READ? Réponse type : +0.00000000E+00,+0.01420000E+00	

- Lorsque la sélection de référence automatique est activée, la première mesure effectuée est utilisée comme valeur de référence pour toutes les mesures suivantes. La commande **[SENSe:]CURRent:{AC|DC}:NULL:VALue** est réglée sur cette valeur. La sélection automatique de la valeur de référence sera désactivée.
- Lorsque la sélection automatique de la valeur de référence est désactivée (OFF), la valeur de référence est spécifiée par la commande suivante : **[SENSe:]CURRent:{AC|DC}:NULL:VALue**.
- L'instrument active la sélection automatique de la valeur de référence lorsque la fonction de mesure par rapport à une référence est activée (**[SENSe:]CURRent:{AC|DC}:NULL:STATe ON**).
- Ce paramètre est défini sur sa valeur par défaut après une réinitialisation de la configuration d'usine (***RST**), un préreglage de l'instrument (**SYSTem:PRESet**) ou l'exécution de la fonction **CONFigure**.

[SENSe:]CURRent:{AC|DC}:RANGe {<plage>|MIN|MAX|DEF}
 [SENSe:]CURRent:{AC|DC}:RANGe? [{MIN|MAX|DEF}]

Sélectionne une plage de mesure fixe pour les mesures en courant alternatif ou en courant continu sur les bornes 3 A. Pour les multimètres numériques dotés d'une plage de 10 A, vous ne pouvez pas sélectionner la plage de 10 A avec cette commande. Utilisez plutôt la commande [SENSe:]CURRent:{AC|DC}:TERMi-nals 10 ou CONF:CURRent:{AC|DC} 10.

REMARQUE Ce paramètre n'est pas commun aux mesures en courant alternatif et courant continu. Les paramètres sont distincts pour les mesures en courant alternatif et courant continu.

REMARQUE Sur les modèles 34461A, 34465A ou 34470A, utilisez la commande [SENSe:]CURRent:{AC|DC}:TERMi-nals pour spécifier les bornes de courant à utiliser pour la mesure.

Paramètre	Renvoi type
<plage> : {100 µA 1 mA 10 mA 100 mA 1 A 3 A}. Valeur par défaut : AUTO (commutation automatique de plage). Les modèles 34465A/34470A comportent des plages de courant continu supplémentaires de 1 µA et 1 mA.	+1.00000000E-01
Configurez les mesures en courant alternatif avec la plage de 1 A. Effectuez et lisez deux mesures : CONF:CURR:AC CURR:AC:RANG 1 SAMP:COUN 2 READ? Réponse type : +1.04530000E+00,+1.04570000E+00	

- La sélection d'une plage fixe ([SENSe:]<fonction>:RANGe) entraîne la désactivation de la commutation automatique de plage.
- Si le signal d'entrée est supérieur au signal pouvant être mesuré dans la plage manuelle spécifiée, l'instrument affiche l'indication *Overload* (Surcharge) sur le panneau avant et renvoie « 9.9E37 » depuis l'interface de commande à distance.
- Contrairement à la commande CONFigure et MEASure?, cette commande ne prend pas en charge la plage de 10 A. La sélection de la borne 10 A à l'aide de la commande [SENSe:]CURRent:{AC|DC}:TERMi-nals force le type de mesure de courant spécifié à utiliser la plage de 10 A, mais n'affecte pas les valeurs de la commande [SENSe:]CURRent:{AC|DC}:RANGe ou [SENSe:]CURRent:{AC|DC}:RANGe:AUTO.
- La modification de la valeur de ce paramètre entraîne toujours celle de la résolution de mesure. Le nombre de PLC (NPLC) demeure fixe, ce qui entraîne un changement de résolution en termes d'unités de mesure. Par exemple, si une mesure possède une résolution de 1 µA sur la plage de 100 mA, le passage à la plage de 1 A produira une résolution de 10 µA.
- Ce paramètre est défini à sa valeur par défaut après une réinitialisation de la configuration d'usine (*RST) ou un préreglage de l'instrument (SYSTem:PRESet).

[SENSe:]CURRent:{AC|DC}:RANGe:AUTO {OFF|ON|ONCE}
 [SENSe:]CURRent:{AC|DC}:RANGe:AUTO?

Désactive ou active la commutation automatique de plage pour les mesures en courant alternatif ou en courant continu. La commutation automatique de plage est pratique car l'instrument sélectionne automatiquement la plage pour chaque mesure en fonction du signal d'entrée.

La saisie de ONCE entraîne immédiatement la commutation automatique de plage, puis la désactivation de la commutation automatique.

REMARQUE Ce paramètre n'est pas commun aux mesures en courant alternatif et courant continu. Les paramètres sont distincts pour les mesures en courant alternatif et courant continu.

REMARQUE Sur les modèles 34461A, 34465A ou 34470A, utilisez la commande [SENSe:]CURRent:{AC|DC}:TERMi-nals pour spécifier les bornes de courant à utiliser pour la mesure.

Paramètre	Renvoi type
{ON 1 OFF 0}. Valeur par défaut : ON.	0 (OFF) ou 1 (ON)
Configurez les mesures en courant continu et effectuez immédiatement une commutation automatique de plage. Effectuez et lisez deux mesures : CONF:CURR:AC CURR:AC:RANG:AUTO ONCE SAMP:COUN 2 READ? Réponse type : +1.04530000E-01,+1.04570000E-01	

- La commutation automatique de plage descend d'une plage à moins de 10 % de la plage et augmente d'une plage à plus de 120 % de la plage.
- Lorsque la commutation automatique de plage est activée, l'instrument sélectionne la plage en fonction du signal d'entrée.
- La sélection d'une plage fixe ([SENSe:]<fonction>:RANGe) entraîne la désactivation de la commutation automatique de plage.
- La sélection de la borne 10 A à l'aide de la commande [SENSe:]CURRent:{AC|DC}:TERMi-nals force le type de mesure de courant spécifié à utiliser la plage de 10 A, mais n'affecte pas les valeurs de la commande [SENSe:]CURRent:{AC|DC}:RANGe ou [SENSe:]CURRent:{AC|DC}:RANGe:AUTO.
- Ce paramètre est défini à sa valeur par défaut après une réinitialisation de la configuration d'usine (*RST) ou un pré réglage de l'instrument (SYSTem:PRESet).

[SENSe:]CURRent:{AC|DC}:TERMinals {3|10}

[SENSe:]CURRent:{AC|DC}:TERMinals?

Configure la mesure en courant alternatif ou continu pour mesurer la source sur les bornes 3 A ou 10 A. Notez que la borne 10 A n'est pas disponible sur le modèle 34460A.

Paramètre	Renvoi type
{3 10}. Valeur par défaut : 3.	+3 ou +10
Configurez les mesures en courant alternatif pour utiliser la borne 10 A. Effectuez et lisez deux mesures : CONF:CURR:AC CURR:AC:TERM 10 SAMP:COUN 2 READ? Réponse type : +7.81929394E+00,7.82013671E+00	

- La sélection de la borne 10 A à l'aide de la commande **[SENSe:]CURRent:{AC|DC}:TERMinals** force le type de mesure de courant spécifié à utiliser la plage de 10 A, mais n'affecte pas les valeurs de la commande **[SENSe:]CURRent:{AC|DC}:RANGe** ou **[SENSe:]CURRent:{AC|DC}:RANGe:AUTO**.
- La modification de la valeur de ce paramètre entraîne toujours celle de la plage de mesure, ce qui provoque à son tour une modification de la résolution de mesure. Le nombre de PLC (NPLC) demeure fixe, ce qui entraîne un changement de résolution en termes d'unités de mesure. Par exemple, si une mesure possède une résolution de 1 µA sur la plage de 1 A, le passage aux bornes de 10 A produira une résolution de 10 µA.
- Ce paramètre est défini à sa valeur par défaut après une réinitialisation de la configuration d'usine (***RST**) ou un pré réglage de l'instrument (**SYSTem:PRESet**).

[SENSe:]CURRent:AC:SECOndary {"OFF"|"CALCulate:DATA"|"FREQuency"|"CURRent[:DC]"}
 [SENSe:]CURRent:AC:SECOndary?

Sélectionne la fonction de mesure secondaire pour les mesures en courant alternatif.

Paramètre	Renvoi type
{"OFF" "CALCulate:DATA" "FREQuency" "CURRent[:DC]"}, "OFF" par défaut	"CALC:DATA"
Configurez les mesures en courant alternatif avec la plage de 1 A. Sélectionnez la fréquence comme mesure secondaire. Effectuez et récupérez des mesures. CONF:CURR:AC 1 CURR:CA:SEC "FREQ" READ?;DATA2? Réponse type : +0.50000000E+00;+1.00000000E+03	

- "CALCulate:DATA" - (Concerne uniquement les modèles 34465A et 34470A.) Valeur de mesure précédant toute opération mathématique (notamment l'opération NULL).
- "FREQuency" - Mesure de fréquence du signal d'entrée.
- « CURRent[:DC] » - Mesure en courant continu du signal d'entrée. S'applique uniquement lors de l'utilisation de l'instrument depuis le panneau avant. Le paramètre est ignoré pour les mesures réalisées à partir d'une interface de commande à distance. Si vous avez besoin de réaliser des mesures en courant alternatif et en courant continu à distance, programmez chaque fonction séparément. Voir **CONFigure:CURRent:{AC|DC}**.
- Ce paramètre est défini à sa valeur par défaut après une réinitialisation de la configuration d'usine (*RST) ou un préréglage de l'instrument (SYSTem:PRESet).

[SENSe:]CURRent[:DC]:APERture {<secondes>|MIN|MAX|DEF}
 [SENSe:]CURRent[:DC]:APERture? [{MIN|MAX|DEF}]

Indique le temps d'intégration en secondes (appelé *temps d'ouverture*) pour toutes les mesures en courant continu.

REMARQUE

Utilisez cette commande pour un contrôle précis du temps d'intégration du multimètre numérique. Pour connaître les caractéristiques optimales de réjection de bruit de l'alimentation secteur (NPLC > 1), utilisez le NPLC (voir **[SENSe:]VOLTage[:DC]:NPLC**).

Paramètre	Renvoi type
(Sans l'option DIG) 200 µs à 1 s (résolution de 2 µs), valeur par défaut : 100 ms. (Avec l'option DIG) 20 µs à 1 s (résolution de 2 µs), valeur par défaut : 100 ms.	+1.00000000E-01
Activer le mode temps d'ouverture, définir le temps d'ouverture à 300 ms : CURR:APER:ENAB ON CURR:DC:APER 300E-03	

- Concerne uniquement les modèles 34465A et 34470A.
- Les commandes [SENSe:]<fonction>:NPLC et [SENSe:]<fonction>:APERture contrôlent le temps d'intégration de l'instrument. En cas d'utilisation de ces deux commandes (déconseillée), la commande envoyée pour la dernière fois remplace l'autre commande et définit le temps d'intégration. L'envoi de la commande [SENSe:]<fonction>:APERture entraîne le réglage de la commande [SENSe:]<fonction>:APERture:ENABLEd sur 1 (Activé) ; l'envoi de la commande [SENSe:]<fonction>:NPLC entraîne son réglage sur 0 (Désactivé).
- Ce paramètre est défini à sa valeur par défaut après une réinitialisation de la configuration d'usine (*RST) ou un préréglage de l'instrument (SYSTem:PRESet).

[SENSe:]CURRent[:DC]:APERture:ENABLEd {ON|1|OFF|0}

[SENSe:]CURRent[:DC]:APERture:ENABLEd?

Active le réglage du temps d'intégration en secondes (appelé *temps d'ouverture*) pour les mesures en courant continu. Si le mode Temps d'ouverture est désactivé (par défaut), le temps d'intégration est défini en PLC (cycles de tension d'alimentation).

Paramètre	Renvoi type
{ON 1 OFF 0}. Valeur par défaut : OFF.	0 (OFF) ou 1 (ON)
Activer le mode temps d'ouverture, définir le temps d'ouverture à 300 ms :	
CURR:APER:ENAB ON	
CURR:DC:APER 300E-03	

- Concerne uniquement les modèles 34465A et 34470A.
- Les commandes CONFigure:CURRent[:DC], MEASure:CURRent[:DC]?, [SENSe:]CURRent[:DC]:NPLC et [SENSe:]CURRent[:DC]:RESolution désactivent le mode temps d'ouverture et sélectionnent un temps d'intégration en nombre de cycles de tension d'alimentation.
- Ce paramètre est défini à sa valeur par défaut après une réinitialisation de la configuration d'usine (*RST) ou un préréglage de l'instrument (SYSTem:PRESet).

[SENSe:]CURREnt[:DC]:NPLC {<PLC>|MIN|MAX|DEF}
 [SENSe:]CURREnt[:DC]:NPLC? [{MIN|MAX|DEF}]

Définit le temps d'intégration en nombre de cycles de tension d'alimentation (PLC) pour les mesures en courant continu. Le temps d'intégration est la période durant laquelle le convertisseur analogique-numérique (CAN) de l'instrument échantillonne le signal d'entrée pour une mesure. Un temps d'intégration plus long permet d'améliorer la résolution de mesure, mais ralentit la vitesse de mesure.

REMARQUE Sur les modèles 34461A, 34465A ou 34470A, utilisez la commande [SENSe:]CURREnt:{AC|DC}:TERMi-nals pour spécifier les bornes de courant à utiliser pour la mesure.

Paramètre	Renvoi type
0,02 ; 0,2 ; 1 ; 10 ; 100. Valeur par défaut : 10 (34460A/61A) 0,02 ; 0,06 ; 0,2 ; 1 ; 10 ; 100. Valeur par défaut : 10 (34465A/70A sans option DIG) 0,001 ; 0,002 ; 0,006 ; 0,02 ; 0,06 ; 0,2 ; 1 ; 10 ; 100. Valeur par défaut : 10 (34465A/70A avec l'option DIG) Pour de plus amples informations, reportez-vous à la section Plage, résolution et NPLC .	+1.00000000E+00
Configurez les mesures en courant continu avec un temps d'intégration de 10 PLC. Puis, effectuez et lisez une mesure : CONF:CURREnt:DC CURREnt:DC:NPLC 10 READ? Réponse type : +6.27530000E-01	

- La sélection d'un temps d'intégration en cycles d'alimentation remplace une ouverture définie avec la commande [SENSe:]{RESistance|FRESistance}:APERture.
- Seuls les temps d'intégration de 1, 10 et 100 PLC permettent une réjection (du bruit de fréquence réseau) en mode normal.
- Le réglage du temps d'intégration entraîne également celui de la résolution de mesure. Le **tableau de résolution** décrit le rapport entre le temps d'intégration et la résolution.
- Ce paramètre est défini à sa valeur par défaut après une réinitialisation de la configuration d'usine (*RST) ou un pré-réglage de l'instrument (SYSTem:PRESet).

Voir également

[SENSe:]CURREnt[:DC]:RESolution

[SENSe:]CURREnt[:DC]:RESolution {<résolution>|MIN|MAX|DEF}
[SENSe:]CURREnt[:DC]:RESolution? [{MIN|MAX|DEF}]

Sélectionne une résolution pour les mesures en courant continu. Saisissez la résolution dans les mêmes unités que pour la fonction de mesure sélectionnée, et non en nombre de chiffres.

REMARQUE Sur les modèles 34461A, 34465A ou 34470A, utilisez la commande **[SENSe:]CURREnt:{AC|DC}:TERMi-nals** pour spécifier les bornes de courant à utiliser pour la mesure.

Paramètre	Renvoi type
Spécifiez la <résolution> dans les unités de mesure (V, A, Hz, Ω, etc.).	+3.00000000E-05
Configurez les mesures en courant continu avec une résolution de 3 µV. Puis, effectuez et lisez une mesure : CONF:CURR:DC 1 CURR:DC:RES 3E-6 READ? Réponse type : +6.27531500E-01	

- Vous pouvez spécifier MIN (meilleure résolution) ou MAX (pire résolution) à la place de <résolution>.
- Pour obtenir une réjection (du bruit de fréquence réseau) en mode normal, utilisez une résolution qui correspond à un temps d'intégration représentant un nombre entier de cycles de tension d'alimentation.
- Ce paramètre est défini à sa valeur par défaut après une réinitialisation de la configuration d'usine (*RST) ou un préréglage de l'instrument (SYSTem:PRESet).

Voir également

[SENSe:]CURREnt[:DC]:NPLC

[SENSe:]CURRent[:DC]:SECOndary {"OFF"|"CALCulate:DATA"|"CURRent:AC"|"PTPeak"}
[SENSe:]CURRent[:DC]:SECOndary?

Sélectionne la fonction de mesure secondaire pour les mesures en courant continu.

Paramètre	Renvoi type
{"OFF" "CALCulate:DATA" "CURRent:AC" "PTPeak"}, "OFF" par défaut	"CALC:DATA"
Configurez les mesures en courant continu avec la plage de 1 A et une résolution de 1 mA. Sélectionnez la mesure secondaire Crête à crête. Effectuez et récupérez des mesures. CONF:CURR:DC 1,0.001 CURR:DC:SEC "PTP" READ?;DATA2? Réponse type : +5.54141768E-06;+9.91000000E+3,+9.91000000E+3	

- "CALCulate:DATA" - (Concerne uniquement les modèles 34465A et 34470A.) Valeur de mesure précédant toute opération mathématique (notamment l'opération NULL).
- « CURRent:AC » - Mesure en courant alternatif du signal d'entrée. S'applique uniquement lors de l'utilisation de l'instrument depuis le panneau avant. Le paramètre est ignoré pour les mesures réalisées à partir d'une interface de commande à distance. Si vous avez besoin de réaliser des mesures en courant alternatif et en courant continu à distance, programmez chaque fonction séparément. Voir [CONFigure:CURRent:{AC|DC}](#).
- "PTPeak" - Valeurs crête à crête, maximale et minimale du signal d'entrée.
- Ce paramètre est défini à sa valeur par défaut après une réinitialisation de la configuration d'usine (*RST) ou un préréglage de l'instrument (SYSTem:PRESet).

[SENSe:]CURRent[:DC]:ZERO:AUTO {OFF|ON|ONCE}

[SENSe:]CURRent[:DC]:ZERO:AUTO?

Désactive/active le mode de réglage automatique du zéro pour les mesures en courant continu.

REMARQUE Sur les modèles 34461A, 34465A ou 34470A, utilisez la commande [SENSe:]CURRent:{AC|DC}:TERMi-nals pour spécifier les bornes de courant à utiliser pour la mesure.

Paramètre	Renvoi type
{OFF ON ONCE}. Valeur par défaut : ON.	0 (OFF) ou 1 (ON)
Configurez les mesures en courant continu et effectuez immédiatement un réglage automatique du zéro. Effectuez et lisez deux mesures : CONF:CURR:DC 1 CURR:DC:ZERO:AUTO ONCE SAMP:COUN 2 READ? Réponse type : +1.04530000E-01,+1.04570000E-01	

- **ON (valeur par défaut)** : le multimètre numérique mesure en interne le décalage après chaque mesure. Il soustrait ensuite cette mesure de la lecture précédente. Cette méthode évite que des tensions de décalage existantes sur le circuit d'entrée de l'instrument ne compromettent la précision de mesure.
- **OFF** : l'instrument utilise la dernière mesure de zéro effectuée et la soustrait de chaque mesure. Il recueille une nouvelle mesure du zéro chaque fois que vous modifiez la fonction, la plage ou le temps d'intégration.
- **ONCE** : l'instrument effectue une mesure du zéro et désactive le réglage automatique du zéro. La mesure du zéro effectuée est utilisée pour toutes les mesures suivantes jusqu'à la prochaine modification de la fonction, de la plage ou du temps d'intégration. Si le temps d'intégration spécifié est inférieur à 1 PLC, la mesure du zéro est effectuée à 1 PLC pour optimiser la réjection du bruit. Les mesures suivantes sont effectuées au temps d'intégration (< 1 PLC) rapide spécifié.
- Le mode de réglage automatique du zéro est défini indirectement lorsque vous configurez la résolution et le temps d'intégration à l'aide des commandes **CONFigure:CURRent:DC** ou **MEASure:CURRent:DC?**. Le réglage automatique du zéro est désactivé automatiquement lorsque vous choisissez un temps d'intégration inférieur à 1 PLC à l'aide de ces commandes.
- Ce paramètre est défini à sa valeur par défaut après une réinitialisation de la configuration d'usine (***RST**) ou un pré-réglage de l'instrument (**SYSTem:PRESet**).

[SENSe:]CURRent:SWITCh:MODE {FAST|CONTInuous}
 [SENSe:]CURRent:SWITCh:MODE?

Sélectionne le mode de changement de plage FAST ou CONTInuous pour les mesures en courant alternatif et en courant continu.

Paramètre	Renvoi type
{FAST CONTInuous}. Valeur par défaut : CONT	CONT
<p>Configurez les mesures en courant continu avec la plage de 1 mA. Spécifiez le mode CONTInuous. Effectuez et lisez deux mesures :</p> <pre>CONF:CURR:DC .001 CURR:SWIT:MODE CONT SAMP:COUN 2 READ?</pre> <p>Modifie la plage de courant à 1 V (aucun circuit ouvert ne se produit lors du changement de plage). Effectuez et lisez deux mesures :</p> <pre>CONF:CURR:DC 1 SAMP:COUN 2 READ?</pre> <p>Réponse type : -5.28836573E-02,-5.01252821E-02</p>	

- Concerne uniquement les modèles 34465A et 34470A.
- Le multimètre numérique mesure le courant alternatif ou continu en mesurant la chute de tension sur l'un des nombreux shunts de courant interne, puis en calculant le courant. Un shunt différent est utilisé selon la plage de courant sélectionnée. En mode CONTInuous (par défaut), lors d'un changement de plage de courant, le multimètre numérique active une faible impédance en parallèle au premier shunt avant de passer au shunt suivant. Cela permet d'éliminer le circuit ouvert momentané lors d'un changement de plage, mais l'opération peut prendre jusqu'à trois fois plus de temps qu'en mode FAST. En mode FAST, lorsqu'un changement de plage provoque le basculement du multimètre d'un shunt vers un autre, une rupture se produit sur les bornes d'entrée de courant. Dans la plupart des cas, ce circuit ouvert n'affecte pas les mesures de courant. Cependant, si un circuit ouvert affecte votre circuit ou vos mesures, vous pouvez utiliser le mode CONTInuous.
- Le mode de commutation s'applique uniquement aux bornes de courant 3 A. Les bornes 10A sont toujours effectivement en mode FAST.
- Ce paramètre est défini à sa valeur par défaut après une réinitialisation de la configuration d'usine (*RST) ou un préreglage de l'instrument (SYSTem:PRESet).

Sous-système [SENSe:]DATA2

Ce sous-système récupère ou efface des mesures secondaires.

[SENSe:]DATA2?

Récupère la mesure secondaire.

Paramètre	Renvoi type
(aucun)	Voir l'exemple ci-dessous
<p>Configurez les mesures en tension continue avec la plage de 10 V et la résolution de 1 mV. Sélectionnez la mesure secondaire Crête à crête. Effectuez et récupérez des mesures.</p> <pre>CONF:VOLT:DC 10,0.001 VOLT:DC:SEC "PTP" READ?;DATA2?</pre> <p>Réponse type : -1.84694879E-03;-2.23115575E-03,+5.98403324E-04,+2.82955909E-03 (<i>Données renvoyées dans l'ordre suivant : Lecture de tension continue, Crête min., Crête max., Crête à crête</i>)</p>	

- Renvoie les valeurs 1, 2 ou 3 selon la mesure secondaire active. Par exemple, le rapport renvoie 2 valeurs (mesures aux bornes principale et de mesure) ; PTPeak renvoie 3 valeurs (crête minimale, crête maximale, crête à crête).
- Si aucune mesure secondaire valide n'est actuellement spécifiée, la requête renvoie "9.91000000E+37" (qui correspond à la définition de *Pas un nombre* de la norme IEEE488.2 - généralement appelé NaN).
- Configurez des mesures secondaires à l'aide de la commande [SENSe:]CAPacitance:SECondary, [SENSe:]CURRent:AC:SECondary, [SENSe:]CURRent:DC:SECondary, [SENSe:]FREQuency:SECondary, [SENSe:]PERiod:SECondary, [SENSe:]TEMPerature:SECondary, [SENSe:]VOLTage:AC:SECondary, [SENSe:]VOLTage:DC:SECondary ou [SENSe:]VOLTage[:DC]:RATio:SECondary.
- Utilisez la commande READ? ou INITiate pour lancer la mesure. Utilisez la commande DATA2? pour récupérer la mesure secondaire.
- L'instrument efface toutes les mesures de la mémoire lorsque la configuration de mesure change ou lorsque l'une des commandes suivantes est exécutée : INITiate, MEASure:<fonction>?, READ?, *RST, SYSTem:PRESet.

[SENSe:]DATA2:CLEar[:IMMediate]

Efface le(s) dernier(s) résultat(s) de la mesure secondaire. Cette commande est généralement utilisée pour effacer l'historique cumulé de la fonction crête à crête (**[SENSe:]VOLT:[DC:]SEConDary "PTPeak"** ou **[SENSe:]CURRent:[DC:]SEConDary "PTPeak"**).

Paramètre	Renvoi type
(aucun)	Voir l'exemple ci-dessous
<p>Configurez les mesures en tension continue avec la plage de 10 V et la résolution de 1 mV. Sélectionnez la mesure secondaire Crête à crête. Effectuez et récupérez des mesures.</p> <p>CONF:VOLT:DC 10,0.001 VOLT:DC:SEC "PTP" READ?;DATA2?</p> <p>Réponse type : -1.84694879E-03;-2.23115575E-03,+5.98403324E-04,+2.82955909E-03 (<i>Données renvoyées dans l'ordre suivant : Lecture de tension continue, Crête min., Crête max., Crête à crête</i>)</p> <p>Ultérieurement, effacez les données de mesure secondaires crête à crête. Effectuez et récupérez des mesures.</p> <p>DATA2:CLE READ?;DATA2?</p> <p>Réponse type : +1.29177114E-03;+6.07221096E-04,+3.43677658E-03,+2.82955548E-03 (<i>Données renvoyées dans l'ordre suivant : Lecture de tension continue, Crête min., Crête max., Crête à crête</i>)</p>	

Sous-système [SENSe:]{FREQuency|PERiod}

Ce sous-système configure les mesures de fréquence et de période.

Récapitulatif des commandes

[SENSe:]{FREQuency|PERiod}:APERture

[SENSe:]{FREQuency|PERiod}:NULL[:STATe]

[SENSe:]{FREQuency|PERiod}:NULL:VALue

[SENSe:]{FREQuency|PERiod}:NULL:VALue:AUTO

[SENSe:]{FREQuency|PERiod}:RANGe:LOWer

[SENSe:]{FREQuency|PERiod}:TIMEout:AUTO

[SENSe:]{FREQuency|PERiod}:VOLTage:RANGe

[SENSe:]{FREQuency|PERiod}:VOLTage:RANGe:AUTO

[SENSe:]FREQuency:SECOndary

[SENSe:]PERiod:SECOndary

[SENSe:]{FREQuency|PERiod}:APERture {<secondes>|MIN|MAX|DEF}
 [SENSe:]{FREQuency|PERiod}:APERture? [{MIN|MAX|DEF}]

Définit le temps d'ouverture (temps de porte) pour les mesures de fréquence et de période.

REMARQUE Ce paramètre est commun aux mesures de fréquence et de période. Les versions FREQuency ou PERiod de cette commande peuvent être toutes deux utilisées pour définir ou rechercher le paramètre.

Paramètre	Renvoi type
{1 mS 10 ms 100 ms 1 s}. Valeur par défaut : 100 ms.	+1.00000000E-01
Configurer les mesures de fréquence avec une ouverture de 1 s, effectuer une mesure et renvoyer le résultat : CONF:FREQ FREQ:APER 1 READ?	

- L'ouverture de 1 mS concerne uniquement les modèles 34465A et 34470A.
- L'ouverture pour les mesures de fréquence et de période ne sélectionne pas automatiquement la plage.
- La résolution de mesure est liée à l'ouverture (temps de porte) comme suit :

Résolution (34460A/61A)	Résolution (34465A/70A)	Ouverture
Sans objet	100 ppm × <plage> (MAXimum)	1 ms
100 ppm × <plage> (MAXimum)	10 ppm × <plage> (DEFault)	10 ms
10 ppm × <plage> (DEFault)	1 ppm × <plage>	100 ms
1 ppm × <plage> (MINimum)	0,1 ppm × <plage> (MINimum)	1 s

- Ce paramètre est défini à sa valeur par défaut après une réinitialisation de la configuration d'usine (*RST) ou un pré réglage de l'instrument (SYSTem:PRESet).

[SENSe:]{FREQuency|PERiod}:NULL[:STATe] {ON|1|OFF|0}
[SENSe:]{FREQuency|PERiod}:NULL[:STATe]?

Active/désactive la fonction de mesure par rapport à une référence pour les mesures de fréquence et de période.

REMARQUE Contrairement aux commandes de plage et d'ouverture SENSE:FREQuency et SENSE:PERiod, ce paramètre n'est pas commun aux mesures de fréquence et de période. Les paramètres de mesure par rapport à une référence sont distincts pour les mesures de fréquence et de période.

Paramètre	Renvoi type
{ON 1 OFF 0}. Valeur par défaut : OFF.	0 (OFF) ou 1 (ON)
Configurez les mesures en tension alternative à l'aide de la fonction de mesure par rapport à une référence pour soustraire 1 kHz des mesures. Effectuez et lisez deux mesures : CONF:FREQ FREQ:NULL:STAT ON;VAL 1 kHz SAMP:COUN 2 READ? Réponse type : +1.04530000E+03,+1.04570000E+03	

- L'activation de la fonction de réglage d'échelle entraîne également celle de la sélection automatique de la valeur de référence (**[SENSe:]{FREQuency|PERiod}:NULL:VALue:AUTO ON**).
- Pour définir une valeur de référence fixe, utilisez la commande suivante : **[SENSe:]{FREQuency|PERiod}:NULL:VALue**.
- L'instrument désactive la fonction de mesure par rapport à une référence après une réinitialisation de la configuration d'usine (***RST**), un pré-réglage de l'instrument (**SYSTem:PRESet**) ou l'exécution de la fonction **CONFigure**.

[SENSe:]{FREQuency|PERiod}:NULL:VALue { <valeur>|MIN|MAX|DEF}
 [SENSe:]{FREQuency|PERiod}:NULL:VALue? [{MIN|MAX|DEF}]

Enregistre une valeur de référence pour les mesures de fréquence et de période.

REMARQUE Contrairement aux commandes de plage et d'ouverture SENSE:FREQuency et SENSE:PERiod, ce paramètre n'est pas commun aux mesures de fréquence et de période. Les paramètres de mesure par rapport à une référence sont distincts pour les mesures de fréquence et de période.

Paramètre	Renvoi type
Fréquence : -1.2E6 à +1.2E6 Valeur par défaut : 0. Période : -1,2 à +1,2 seconde. Valeur par défaut : 0.	+1.00000000E-02
Configurez les mesures en tension alternative à l'aide de la fonction de mesure par rapport à une référence pour soustraire 1 kHz des mesures. Effectuez et lisez deux mesures : CONF:FREQ FREQ:NULL:STAT ON;VAL 1 kHz SAMP:COUN 2 READ? Réponse type : +1.04530000E+03,+1.04570000E+03	

- La saisie d'une valeur de référence entraîne la désactivation de la sélection automatique de la valeur de référence ([SENSe:]{FREQuency|PERiod}:NULL:VALue:AUTO OFF).
- Pour utiliser la valeur de référence, l'état Null doit être activé ([SENSe:]{FREQuency|PERiod}:NULL:STATe ON).
- Ce paramètre est défini sur sa valeur par défaut après une réinitialisation de la configuration d'usine (*RST), un pré réglage de l'instrument (SYSTem:PRESet) ou l'exécution de la fonction CONFigure.

[SENSe:]{FREQuency|PERiod}:NULL:VALue:AUTO {ON|1|OFF|0}
 [SENSe:]{FREQuency|PERiod}:NULL:VALue:AUTO?

Active/désactive la sélection automatique de la valeur de référence pour les mesures de fréquence et de période.

REMARQUE Contrairement aux commandes de plage et d'ouverture SENSE:FREQuency et SENSE:PERiod, ce paramètre n'est pas commun aux mesures de fréquence et de période. Les paramètres de mesure par rapport à une référence sont distincts pour les mesures de fréquence et de période.

Paramètre	Renvoi type
{ON 1 OFF 0}. Valeur par défaut : OFF.	0 (OFF) ou 1 (ON)

Paramètre	Renvoi type
<p>Configurez les mesures de fréquence à l'aide de la fonction de mesure par rapport à une référence pour soustraire 1 kHz de ces dernières. Effectuez et lisez deux mesures :</p> <p>CONF:FREQ FREQ:NULL:STAT ON;VAL 1 kHz SAMP:COUN 2 READ?</p> <p>Réponse type : +1.04530000E+00,+1.04570000E+00</p> <p>Effectuer un deuxième jeu de mesures à l'aide de la fonction de sélection automatique de la valeur de référence :</p> <p>FREQ:NULL:VAL:AUTO ON READ?</p> <p>Réponse type : +0.00000000E+00,+0.01420000E+00</p>	

- Lorsque la sélection de référence automatique est activée, la première mesure effectuée est utilisée comme valeur de référence pour toutes les mesures suivantes. La commande **[SENSe:]{FREQuency|PERiod}:NULL:VALue** est réglée sur cette valeur. La sélection automatique de la valeur de référence sera désactivée.
- Lorsque la sélection automatique de la valeur de référence est désactivée (OFF), la valeur de référence est spécifiée par la commande suivante : **[SENSe:]{FREQuency|PERiod}:NULL:VALue**.
- L'instrument active la sélection automatique de la valeur de référence lorsque la fonction de mesure par rapport à une référence est activée (**[SENSe:]{FREQuency|PERiod}:NULL:STATe ON**).
- Ce paramètre est défini sur sa valeur par défaut après une réinitialisation de la configuration d'usine (***RST**), un pré-réglage de l'instrument (**SYSTem:PRESet**) ou l'exécution de la fonction **CONFigure**.

[SENSe:]{FREQuency|PERiod}:RANGe:LOWer {<fréq>|MIN|MAX|DEF}
 [SENSe:]{FREQuency|PERiod}:RANGe:LOWer? [{MIN|MAX|DEF}]

Définit la bande passante de courant alternatif utilisée pour détecter le signal lors des mesures de fréquence et de période.

REMARQUE Ce paramètre est commun aux mesures de fréquence et de période. Les versions FREQuency ou PERiod de cette commande peuvent être toutes deux utilisées pour définir ou rechercher le paramètre.

L'instrument utilise trois filtres de courant alternatif différents qui vous permettent d'optimiser la précision en basse fréquence ou de réduire les temps de stabilisation en courant alternatif suite à une variation de l'amplitude du signal d'entrée. L'instrument sélectionne le filtre lent (3 Hz), moyen (20 Hz) ou rapide (200 Hz) selon la fréquence de coupure spécifiée par cette commande. Spécifiez la fréquence la plus basse attendue.

Paramètre	Renvoi type
{3 Hz 20 Hz 200 Hz}. Valeur par défaut : 20 Hz.	+6.27530000E+03
Effectuez et lisez une mesure de fréquence. Utilisez la bande passante de filtre 3 Hz :	
CONF:FREQ FREQ:RANG:LOW 3 READ?	

- Si vous saisissez la fréquence la plus basse attendue, la commande sélectionnera le <filtre> approprié. Par exemple, si vous saisissez 15 Hz, le filtre lent (3 Hz) est sélectionné. Si vous saisissez 190 Hz, le filtre moyen (20 Hz) est sélectionné pour fournir la fréquence de coupure basse appropriée.
- Définissez la fréquence la plus basse que vous espérez trouver. Les bandes passantes inférieures produisent des délais de stabilisation plus longs, comme indiqué ci-dessous :

Fréquence d'entrée	Délai de stabilisation par défaut
3 Hz - 300 kHz (<i>lent</i>)	1,66 s/mesure
20 Hz - 300 kHz (<i>moyen</i>)	0,25 s/mesure
200 Hz - 300 kHz (<i>rapide</i>)	0,025 s/mesure

- Ce paramètre est défini à sa valeur par défaut après une réinitialisation de la configuration d'usine (*RST) ou un pré réglage de l'instrument (SYSTem:PRESet).

[SENSe:]{FREQuency|PERiod}:TIMeout:AUTO {ON|1|OFF|0}

[SENSe:]{FREQuency|PERiod}:TIMeout:AUTO?

Déterminez la durée d'attente de l'instrument avant d'annuler une mesure de fréquence ou de période en l'absence de signal.

Paramètre	Renvoi type
{ON 1 OFF 0}. Valeur par défaut : OFF.	0 (OFF) ou 1 (ON)
Configurez les mesures de fréquence à l'aide de la fonction de mesure par rapport à une référence pour soustraire 1 kHz des mesures. Activez la temporisation automatique. Effectuez et lisez deux mesures : CONF:FREQ FREQ:NULL:STAT ON;VAL 1 kHz TIM:AUTO ON SAMP:COUN 2 READ? Réponse type : +1.04530000E+03,+1.04570000E+03	

- Lorsque le paramètre est défini sur OFF, l'instrument patiente 1 seconde avant d'annuler la mesure. Lorsqu'il est défini sur ON, le délai d'attente varie en fonction de la bande passante du filtre CA ; pour les bandes passantes plus rapides, l'instrument patiente moins longtemps avant d'annuler la mesure et de renvoyer 0.0. Cela est avantageux dans les systèmes de test de fabrication dans lesquels un échec du dispositif testé peut se traduire par une absence de signal ; dans ce cas, l'échec peut être détecté plus tôt et accroître ainsi la cadence du test.
- Ce paramètre est non volatile ; il n'est pas altéré par une remise sous tension ou l'exécution de la commande ***RST** ou **SYSTem:PRESet**.

[SENSe:]{FREQuency|PERiod}:VOLTage:RANGe {<plage>|MIN|MAX|DEF}
 [SENSe:]{FREQuency|PERiod}:VOLTage:RANGe? [{MIN|MAX|DEF}]

Sélectionne une plage de *tension* fixe pour les mesures de fréquence et de période.

REMARQUE Ce paramètre est commun aux mesures de fréquence et de période. Les versions FREQuency ou PERiod de cette commande peuvent être toutes deux utilisées pour définir ou rechercher le paramètre.

AVERTISSEMENT Le paramètre de plage maximal (MAX) est de 1 000 V. Cependant, la LIMITE DE SÉCURITÉ sur les bornes d'entrée HI/LO avant et arrière est de 750 Vca (eff.). La tension efficace vraie dépend du signal. Une onde sinusoïdale est limitée à 750 Vca (eff.), mais une onde carrée de 1 000 V crête est sûre. La connexion à l'alimentation secteur est en outre limitée à la catégorie de mesure II (300 V). Pour de plus amples informations sur les fonctions de sécurité et l'utilisation sans danger de cet instrument, reportez-vous à la section **Informations de sécurité et réglementaires**.

Paramètre	Renvoi type
<plage> : {100 mV 1 V 10 V 100 V 1 000 V}. Valeur par défaut : 10 V	+1.04530000E+03
Configure les mesures de fréquence avec la plage de 10 Vca. Effectuez et lisez deux mesures : CONF:FREQ FREQ:VOLT:RANG 10 SAMP:COUN 2 READ?	

- Le signal d'entrée pour les mesures de fréquence ou de période inclut un composant de *tension alternative*. Sélectionne cette commande pour sélectionner une plage de *tension* fixe pour les mesures de fréquence et de période. Utilisez la commande [SENSe:]{FREQuency|PERiod}:VOLTage:RANGe:AUTO pour désactiver ou activer la commutation automatique de plage ou la commande CONFigure: {FREQuency|PERiod} pour sélectionner la commutation automatique de plage par défaut.
- La sélection d'une plage fixe ([SENSe:]<fonction>:RANGe) entraîne la désactivation de la commutation automatique de plage.
- Si la tension d'entrée est trop élevée pour la plage de tension sélectionnée (commutation manuelle), l'instrument affiche l'indication Overload (Surcharge) sur le panneau avant et renvoie « 9.9E37 » depuis l'interface de commande à distance. La commutation automatique de plage peut être activée pour la tension d'entrée.
- Ce paramètre est défini à sa valeur par défaut après une réinitialisation de la configuration d'usine (*RST) ou un pré réglage de l'instrument (SYSTem:PRESet).

[SENSe:]{FREQuency|PERiod}:VOLTage:RANGe:AUTO {OFF|ON|ONCE}
[SENSe:]{FREQuency|PERiod}:VOLTage:RANGe:AUTO?

Désactive ou active la détection automatique de la *tension* pour les mesures de fréquence et de période. La commutation automatique de plage est pratique car l'instrument sélectionne automatiquement la plage pour chaque mesure en fonction du signal d'entrée.

La saisie de ONCE entraîne immédiatement la commutation automatique de plage, puis la désactivation de la commutation automatique.

REMARQUE Ce paramètre est commun aux mesures de fréquence et de période. Les versions FREQuency ou PERiod de cette commande peuvent être toutes deux utilisées pour définir ou rechercher le paramètre.

AVERTISSEMENT Le paramètre de plage maximal (MAX) est de 1 000 V. Cependant, la LIMITE DE SÉCURITÉ sur les bornes d'entrée HI/LO avant et arrière est de 750 Vca (eff.). La tension efficace vraie dépend du signal. Une onde sinusoïdale est limitée à 750 Vca (eff.), mais une onde carrée de 1 000 V crête est sûre. La connexion à l'alimentation secteur est en outre limitée à la catégorie de mesure II (300 V). Pour de plus amples informations sur les fonctions de sécurité et l'utilisation sans danger de cet instrument, reportez-vous à la section **Informations de sécurité et réglementaires**.

Paramètre	Renvoi type
{OFF ON ONCE}. Valeur par défaut : ON.	0 (OFF) ou 1 (ON)
Configurez les mesures de fréquence et effectuez immédiatement une détection de la tension alternative. Effectuez et lisez deux mesures : CONF:FREQ FREQ:VOLT:RANG:AUTO ONCE SAMP:COUN 2 READ? Réponse type : +1.04530000E+03,+1.04570000E+03	

- Le signal d'entrée pour les mesures de fréquence ou de période inclut un composant de *tension alternative*. Utilisez cette commande pour désactiver ou activer la commutation automatique de plage ou la commande **CONFigure: {FREQuency|PERiod}** pour sélectionner la commutation automatique de plage par défaut. Utilisez la commande **[SENSe:]{FREQuency|PERiod}:VOLTage:RANGe** pour sélectionner une plage de tension fixe pour les mesures de fréquence et de période.
- La commutation automatique de plage descend d'une plage à moins de 10 % de la plage et augmente d'une plage à plus de 120 % de la plage.
- La sélection d'une plage fixe (**[SENSe:]<fonction>:RANGe**) entraîne la désactivation de la commutation automatique de plage.
- Ce paramètre est défini à sa valeur par défaut après une réinitialisation de la configuration d'usine (***RST**) ou un pré réglage de l'instrument (**SYSTem:PRESet**).

[SENSe:]FREQUency:SECOndary {"OFF"|"CALCulate:DATA"|"PERiod"|"VOLTage:AC"}
[SENSe:]FREQUency:SECOndary?

Sélectionne la fonction de mesure secondaire pour les mesures de fréquence.

Paramètre	Renvoi type
{"OFF" "CALCulate:DATA" "PERiod" "VOLTage:AC"}, "OFF" par défaut	"CALC:DATA"
Configurez les mesures de fréquence, sélectionnez la période comme mesure secondaire, effectuez et récupérez des mesures. CONF:FREQ MAX, MAX FREQ:SEC "PERiod" READ?;DATA2? Réponse type : +1.22230020E+02;+8.18129619E-03	

- "CALCulate:DATA" - (Concerne uniquement les modèles 34465A et 34470A.) Valeur de mesure précédant toute opération mathématique (notamment l'opération NULL).
- « PERiod » - Mesure de période du signal d'entrée.
- « VOLTage:AC » - Mesure en tension alternative du signal d'entrée.
- Ce paramètre est défini à sa valeur par défaut après une réinitialisation de la configuration d'usine (*RST) ou un préreglage de l'instrument (SYSTem:PRESet).

[SENSe:]PERiod:SECOndary {"OFF"|"CALCulate:DATA"|"FREQUency"|"VOLTage:AC"}
[SENSe:]PERiod:SECOndary?

Sélectionne la fonction de mesure secondaire pour les mesures de période.

Paramètre	Renvoi type
{"OFF" "CALCulate:DATA" "FREQUency" "VOLTage:AC"}, "OFF" par défaut	"CALC:DATA"
Configurez les mesures de période, sélectionnez la fréquence comme mesure secondaire, effectuez et récupérez des mesures. CONF:PER MAX, MAX PER:SEC "FREQ" READ?;DATA2? Réponse type : +8.90363477E-03;+1.12313682E+02	

- "CALCulate:DATA" - (Concerne uniquement les modèles 34465A et 34470A.) Valeur de mesure précédant toute opération mathématique (notamment l'opération NULL).
- « FREQUency » - Mesure de fréquence du signal d'entrée.
- « VOLTage:AC » - Mesure en tension alternative du signal d'entrée.
- Ce paramètre est défini à sa valeur par défaut après une réinitialisation de la configuration d'usine (*RST) ou un préreglage de l'instrument (SYSTem:PRESet).

Sous-système [SENSe:]{RESistance|FRESistance}

Ce sous-système configure les mesures de résistance en deux et quatre fils.

Récapitulatif des commandes

[SENSe:]{RESistance|FRESistance}:APERture

[SENSe:]{RESistance|FRESistance}:APERture:ENABLEd

[SENSe:]{RESistance|FRESistance}:NPLC

[SENSe:]{RESistance|FRESistance}:NULL[:STATe]

[SENSe:]{RESistance|FRESistance}:NULL:VALue

[SENSe:]{RESistance|FRESistance}:NULL:VALue:AUTO

[SENSe:]{RESistance|FRESistance}:OCOMPensated

[SENSe:]{RESistance|FRESistance}:POWER:LIMit[:STATe]

[SENSe:]{RESistance|FRESistance}:RANGe

[SENSe:]{RESistance|FRESistance}:RANGe:AUTO

[SENSe:]{RESistance|FRESistance}:RESolution

[SENSe:]{FRESistance|RESistance}:SECOndary

[SENSe:]RESistance:ZERO:AUTO

[SENSe:]{RESistance|FRESistance}:APERture {<secondes>|MIN|MAX|DEF}

[SENSe:]{RESistance|FRESistance}:APERture? [{MIN|MAX|DEF}]

Définit le temps d'intégration en secondes (appelé *temps d'ouverture*) pour toutes les mesures de résistance.

REMARQUE

Utilisez cette commande pour un contrôle précis du temps d'intégration du multimètre numérique. Pour connaître les caractéristiques optimales de réjection de bruit de l'alimentation secteur (NPLC > 1), utilisez le NPLC (voir [SENSe:]FRESistance:NPLC).

Ce paramètre est commun aux mesures de résistance en 2 et 4 fils. La version FRESistance de cette commande ou requête est identique à la version RESistance.

Paramètre	Renvoi type
(Sans l'option DIG) 200 µs à 1 s (résolution de 2 µs), valeur par défaut : 100 ms. (Avec l'option DIG) 20 µs à 1 s (résolution de 2 µs), valeur par défaut : 100 ms.	+1.00000000E-01
Activer l'ouverture, définir le temps d'ouverture à 300 millisecondes :	
RES:APER:ENAB ON RES:APER 300E-03	
<i>ou</i>	
FRES:APER:ENAB ON FRES:APER 300E-03	

- Concerne uniquement les modèles 34465A et 34470A.
- Concerne uniquement les mesures de résistance en 2 et 4 fils.
- Les commandes [SENSe:]<fonction>:NPLC et [SENSe:]<fonction>:APERture contrôlent le temps d'intégration de l'instrument. En cas d'utilisation de ces deux commandes (déconseillée), la commande envoyée pour la dernière fois remplace l'autre commande et définit le temps d'intégration. L'envoi de la commande [SENSe:]<fonction>:APERture entraîne le réglage de la commande [SENSe:]<fonction>:APERture:ENABLEd sur 1 (Activé) ; l'envoi de la commande [SENSe:]<fonction>:NPLC entraîne son réglage sur 0 (Désactivé).
- Ce paramètre est défini à sa valeur par défaut après une réinitialisation de la configuration d'usine (*RST) ou un pré-réglage de l'instrument (SYSTem:PRESet).

[SENSe:]{RESistance|FRESistance}:APERture:ENABLEd {ON|1|OFF|0}
 [SENSe:]{RESistance|FRESistance}:APERture:ENABLEd?

Active la définition du temps d'intégration en secondes (appelé *temps d'ouverture*) pour les mesures de résistance. Si le mode Temps d'ouverture est désactivé (par défaut), le temps d'intégration est défini en PLC (cycles de tension d'alimentation).

REMARQUE Ce paramètre est commun aux mesures de résistance en 2 et 4 fils. La version FRESistance de cette commande ou requête est identique à la version RESistance.

Paramètre	Renvoi type
{ON 1 OFF 0}. Valeur par défaut : OFF.	0 (OFF) ou 1 (ON)
Activer l'ouverture, définir le temps d'ouverture à 300 ms :	
RES:APER:ENAB ON RES:APER 300E-03	
<i>ou</i>	
FRES:APER:ENAB ON FRES:APER 300E-03	

- Concerne uniquement les modèles 34465A et 34470A.
- Cette requête détermine si l'ouverture utilisée pour les mesures de température en 2 et 4 fils est activée.
- Les commandes **CONFigure:FRESistance**, **MEASure:FRESistance?**, **[SENSe:]{RESistance|FRESistance}:NPLC** et **[SENSe:]{RESistance|FRESistance}:RESolution** désactivent le mode temps d'ouverture et sélectionnent un temps d'intégration en nombre de cycles de tension d'alimentation.
- Ce paramètre est défini à sa valeur par défaut après une réinitialisation de la configuration d'usine (***RST**) ou un préréglage de l'instrument (**SYSTem:PRESet**).

[SENSe:]{RESistance|FRESistance}:NPLC {<PLC>|MIN|MAX|DEF}
 [SENSe:]{RESistance|FRESistance}:NPLC? [{MIN|MAX|DEF}]

Définit le temps d'intégration en nombre de cycles de tension d'alimentation (PLC) pour toutes les mesures de résistance. Le temps d'intégration est la période durant laquelle le convertisseur analogique-numérique (CAN) de l'instrument échantillonne le signal d'entrée pour une mesure. Un temps d'intégration plus long permet d'améliorer la résolution de mesure, mais ralentit la vitesse de mesure.

REMARQUE Ce paramètre est commun aux mesures de résistance en 2 et 4 fils. La version FRESistance de cette commande ou requête est identique à la version RESistance.

Paramètre	Renvoi type
0,02 ; 0,2 ; 1 ; 10 ; 100. Valeur par défaut : 10 (34460A/61A) 0,02 ; 0,06 ; 0,2 ; 1 ; 10 ; 100. Valeur par défaut : 10 (34465A/70A sans option DIG) 0,001 ; 0,002 ; 0,006 ; 0,02 ; 0,06 ; 0,2 ; 1 ; 10 ; 100. Valeur par défaut : 10 (34465A/70A avec l'option DIG) Pour de plus amples informations, reportez-vous à la section Plage, résolution et NPLC .	+1.00000000E+01
Configurez les mesures de résistance en 4 fils avec un temps d'intégration de 10 PLC. Puis, effectuez et lisez une mesure : CONF:FRES FRES:NPLC 10 READ? Réponse type : +6.27530000E+01	

- La sélection d'un temps d'intégration en cycles d'alimentation remplace un ensemble d'ouverture avec la commande [\[SENSe:\]{RESistance|FRESistance}:APERture](#).
- Seuls les temps d'intégration de 1, 10 et 100 PLC permettent une réjection (du bruit de fréquence réseau) en mode normal.
- Le réglage du temps d'intégration entraîne également celui de la résolution de mesure. Le [tableau de résolution](#) décrit le rapport entre le temps d'intégration et la résolution.
- Ce paramètre est défini à sa valeur par défaut après une réinitialisation de la configuration d'usine (*RST) ou un pré-réglage de l'instrument (SYSTem:PRESet).

[SENSe:]{RESistance|FRESistance}:NULL[:STATe] {ON|1|OFF|0}
 [SENSe:]{RESistance|FRESistance}:NULL[:STATe]?

Active/désactive la fonction de mesure par rapport à une référence pour toutes les mesures de résistance.

REMARQUE Ce paramètre est commun aux mesures de résistance en 2 et 4 fils. La version FRESistance de cette commande ou requête est identique à la version RESistance.

Paramètre	Renvoi type
{ON 1 OFF 0}. Valeur par défaut : OFF.	0 (OFF) ou 1 (ON)
Configurez les mesures de résistance en 2 fils à l'aide de la fonction de mesure par rapport à une référence pour supprimer 100 mΩ de résistance de câblage. Effectuez et lisez deux mesures : CONF:RES RES:NULL:STAT ON;VAL .1 SAMP:COUN 2 READ? Réponse type : +1.04530000E+02,+1.04570000E+02	

- L'activation de la fonction de réglage d'échelle entraîne également celle de la sélection automatique de la valeur de référence (SENSe:){RESistance|FRESistance}:NULL:VALue:AUTO ON).
- Pour définir une valeur de référence fixe, utilisez la commande suivante : [SENSe:]{RESistance|FRESistance}:NULL:VALue.
- L'instrument désactive la fonction de mesure par rapport à une référence après une réinitialisation de la configuration d'usine (*RST), un pré-réglage de l'instrument (SYSTEM:PRESet) ou l'exécution de la fonction CONFIGure.

[SENSe:]{RESistance|FRESistance}:NULL:VALue {<valeur>|MIN|MAX|DEF}
 [SENSe:]{RESistance|FRESistance}:NULL:VALue? [{MIN|MAX|DEF}]

Enregistre une valeur de référence pour toutes les mesures de résistance.

REMARQUE Ce paramètre est commun aux mesures de résistance en 2 et 4 fils. La version FRESistance de cette commande ou requête est identique à la version RESistance.

Paramètre	Renvoi type
-120 MΩ à +120 MΩ. Valeur par défaut : 0. (34460A/61A) -1,2 MΩ à +1,2 MΩ. Valeur par défaut : 0. (34465A/70A)	+1.04530000E+02
Configurez les mesures de résistance en 2 fils à l'aide de la fonction de mesure par rapport à une référence pour supprimer 100 mΩ de résistance de câblage. Effectuez et lisez deux mesures : CONF:RES RES:NULL:STAT ON;VAL .1 SAMP:COUN 2 READ? Réponse type : +1.04530000E+02,+1.04570000E+02	

- La saisie d'une valeur de référence entraîne la désactivation de la sélection automatique de la valeur de référence ([SENSe:]{RESistance|FRESistance}:NULL:VALue:AUTO OFF).
- Pour utiliser la valeur de référence, l'état Null doit être activé ([SENSe:]{RESistance|FRESistance}:NULL:STATe ON).
- Ce paramètre est défini sur sa valeur par défaut après une réinitialisation de la configuration d'usine (*RST), un pré réglage de l'instrument (SYSTem:PRESet) ou l'exécution de la fonction CONFIGure.

[SENSe:]{RESistance|FRESistance}:NULL:VALue:AUTO {ON|1|OFF|0}
[SENSe:]{RESistance|FRESistance}:NULL:VALue:AUTO?

Active/désactive la sélection automatique de la valeur de référence pour toutes les mesures de résistance.

REMARQUE Ce paramètre est commun aux mesures de résistance en 2 et 4 fils. La version FRESistance de cette commande ou requête est identique à la version RESistance.

Paramètre	Renvoi type
{ON 1 OFF 0}. Valeur par défaut : OFF.	0 (OFF) ou 1 (ON)
<p>Configurez les mesures de résistance en 2 fils à l'aide de la fonction de mesure par rapport à une référence pour supprimer 100 mΩ de résistance de câblage. Effectuez et lisez deux mesures :</p> <pre>CONF:RES RES:NULL:STAT ON;VAL .1 SAMP:COUN 2 READ?</pre> <p>Réponse type : +1.04530000E+02,+1.04570000E+02</p> <p>Effectuer un deuxième jeu de mesures à l'aide de la fonction de sélection automatique de la valeur de référence :</p> <pre>RES:NULL:VAL:AUTO ON READ?</pre> <p>Réponse type : +0.00000000E+00,+0.01420000E+00</p>	

- Lorsque la sélection de référence automatique est activée, la première mesure effectuée est utilisée comme valeur de référence pour toutes les mesures suivantes. La commande **[SENSe:]{RESistance|FRESistance}:NULL:VALue** est réglée sur cette valeur. La sélection automatique de la valeur de référence sera désactivée.
- Lorsque la sélection automatique de la valeur de référence est désactivée (OFF), la valeur de référence est spécifiée par la commande suivante : **[SENSe:]{RESistance|FRESistance}:NULL:VALue**.
- L'instrument active la sélection automatique de la valeur de référence lorsque la fonction de mesure par rapport à une référence est activée (**[SENSe:]{RESistance|FRESistance}:NULL:STATe ON**).
- Ce paramètre est défini sur sa valeur par défaut après une réinitialisation de la configuration d'usine (***RST**), un pré réglage de l'instrument (**SYSTem:PRESet**) ou l'exécution de la fonction **CONFigure**.

[SENSe:]{RESistance|FRESistance}:OCOMpensated {OFF|ON}
[SENSe:]{RESistance|FRESistance}:OCOMpensated?

Active ou désactive la compensation de décalage. La compensation de décalage élimine les effets de faibles tensions continues dans le circuit mesuré. La méthode consiste à recueillir la différence entre deux mesures de résistance, une avec la source de courant réglée sur la valeur normale et l'autre avec la source de courant réglée sur une valeur inférieure. L'activation de la compensation de décalage multiplie environ par deux le temps de lecture.

REMARQUE Ce paramètre est commun aux mesures de résistance en 2 et 4 fils. La version FRESistance de cette commande ou requête est identique à la version RESistance.

Paramètre	Renvoi type
{ON 1 OFF 0}. Valeur par défaut : OFF.	0 (OFF) ou 1 (ON)
Configurez les mesures de résistance en 2 fils de basse puissance. Activez la compensation de décalage. Effectuez et lisez deux mesures : RES:POW:LIM ON RES:OCOM ON SAMP:COUN 2 READ? Réponse type : +4.05451008E-03,+4.97391062E-03	

- Concerne uniquement les modèles 34465A et 34470A.
- Concerne uniquement les mesures de résistance en 2 et 4 fils.
- Cette méthode ne s'applique qu'aux mesures de résistances en 2 et 4 fils sur les plages 100 Ω, 1 kΩ, 10 kΩ et 100 kΩ.
- Ce paramètre est défini à sa valeur par défaut après une réinitialisation de la configuration d'usine (*RST) ou un préréglage de l'instrument (SYSTem:PRESet).

[SENSe:]{RESistance|FRESistance}:POWer:LIMit[:STATe] {OFF|ON}
 [SENSe:]{RESistance|FRESistance}:POWer:LIMit[:STATe]?

Active ou désactive les mesures de résistance de basse puissance (2 ou 4 fils).

REMARQUE Ce paramètre est commun aux mesures de résistance en 2 et 4 fils. La version FRESistance de cette commande ou requête est identique à la version RESistance.

Paramètre	Renvoi type
{ON 1 OFF 0}. Valeur par défaut : OFF.	0 (OFF) ou 1 (ON)
Configurez les mesures de résistance en 4 fils avec un temps d'intégration de 10 PLC. Configurez les mesures de résistance en 4 fils de basse puissance. Puis, effectuez et lisez une mesure : CONF:FRES FRES:NPLC 10 FRES:POW:LIM ON READ? Réponse type : +6.27530000E+01	

- Concerne uniquement les modèles 34465A et 34470A.
- Ce paramètre est défini à sa valeur par défaut après une réinitialisation de la configuration d'usine (*RST) ou un pré-réglage de l'instrument (SYSTem:PRESet).
- Les mesures de résistance de basse puissance s'appliquent uniquement aux plages 100 Ω-100 kΩ. Les plages 1 MΩ-1 GΩ génèrent le même courant, quel que soit le réglage de basse puissance.

[SENSe:]{RESistance|FRESistance}:RANGe {<plage>|MIN|MAX|DEF}
 [SENSe:]{RESistance|FRESistance}:RANGe? [{MIN|MAX|DEF}]

Sélectionne une plage de mesure fixe pour toutes les mesures de résistance.

REMARQUE Ce paramètre est commun aux mesures de résistance en 2 et 4 fils. La version FRESistance de cette commande ou requête est identique à la version RESistance.

Paramètre	Renvoi type
{100 Ω 1 kΩ 10 kΩ 100 kΩ 1 MΩ 10 MΩ 100 MΩ 1 GΩ}. Valeur par défaut : 1 kΩ.	+1.00000000E+03
Configurez les mesures de résistance en 2 fils avec la plage 10 kΩ. Puis, effectuez et lisez une mesure : CONF:RES RES:RANG 10E3 READ? Réponse type : +6.27530000E+03	

- La plage de 1 GΩ concerne uniquement les modèles 34465A et 34470A.
- La sélection d'une plage fixe ([SENSe:]<fonction>:RANGe) entraîne la désactivation de la commutation automatique de plage.

- Si le signal d'entrée est supérieur au signal pouvant être mesuré dans la plage manuelle spécifiée, l'instrument affiche l'indication *Overload* (Surcharge) sur le panneau avant et renvoie « 9.9E37 » depuis l'interface de commande à distance.

Voir également

[SENSe:]{RESistance|FRESistance}:RANGe:AUTO

[SENSe:]{RESistance|FRESistance}:RANGe:AUTO {OFF|ON|ONCE}

[SENSe:]{RESistance|FRESistance}:RANGe:AUTO?

Désactive/active la commutation automatique de plage pour toutes les mesures de résistance. La commutation automatique de plage est pratique car l'instrument sélectionne automatiquement la plage pour chaque mesure en fonction du signal d'entrée. La saisie de ONCE entraîne immédiatement la commutation automatique de plage, puis la désactivation de la commutation automatique.

REMARQUE Ce paramètre est commun aux mesures de résistance en 2 et 4 fils. La version FRESistance de cette commande ou requête est identique à la version RESistance.

Paramètre	Renvoi type
{ON 1 OFF 0}. Valeur par défaut : ON.	0 (OFF) ou 1 (ON)
Configurez les mesures de résistance en 2 fils et effectuez immédiatement une commutation automatique de plage. Effectuez et lisez deux mesures : CONF:RES RES:RANG:AUTO ONCE SAMP:COUN 2 READ? Réponse type : +1.04530000E+03,+1.04570000E+03	

- La commutation automatique de plage descend d'une plage à moins de 10 % de la plage et augmente d'une plage à plus de 120 % de la plage.
- Lorsque la commutation automatique de plage est activée, l'instrument sélectionne la plage en fonction du signal d'entrée.
- La sélection d'une plage fixe ([SENSe:]<fonction>:RANGe) entraîne la désactivation de la commutation automatique de plage.
- Ce paramètre est défini à sa valeur par défaut après une réinitialisation de la configuration d'usine (*RST) ou un préréglage de l'instrument (SYSTem:PRESet).

[SENSe:]{RESistance|FRESistance}:RESolution {<résolution>|MIN|MAX|DEF}
 [SENSe:]{RESistance|FRESistance}:RESolution? [{MIN|MAX|DEF}]

Sélectionne la résolution de toutes les mesures de résistance. Saisissez la résolution dans les mêmes unités que pour la fonction de mesure sélectionnée, et non en nombre de chiffres.

REMARQUE Ce paramètre est commun aux mesures de résistance en 2 et 4 fils. La version FRESistance de cette commande ou requête est identique à la version RESistance.

Paramètre	Renvoi type
<résolution> : Voir Tableau de résolution ou Plage, résolution et NPLC . La valeur par défaut est équivalente à 10 PLC. Spécifiez la <résolution> dans les unités de mesure (V, A, Hz, Ω, etc.).	+3.00000000E+00
Configurez les mesures de résistance en 2 fils avec une résolution de 3 Ω. Puis, effectuez et lisez une mesure : CONF:RES 1E6 RES:RES 3 READ? Réponse type : +6.27531500E+05	

- Vous pouvez spécifier MIN (meilleure résolution) ou MAX (pire résolution) à la place de <résolution>.
- Pour obtenir une réjection (du bruit de fréquence réseau) en mode normal, utilisez une résolution qui correspond à un temps d'intégration représentant un nombre entier de cycles de tension d'alimentation.
- Ce paramètre est défini à sa valeur par défaut après une réinitialisation de la configuration d'usine (*RST) ou un pré réglage de l'instrument (SYSTem:PRESet).

Voir également

[SENSe:]{RESistance|FRESistance}:NPLC

[SENSe:]{FREStance|RESistance}:SECondary {"OFF"|"CALCulate:DATA"}
 [SENSe:]{FREStance|RESistance}:SECondary?

Sélectionne la fonction de mesure secondaire pour toutes les mesures de résistance.

Paramètre	Renvoi type
{"OFF" "CALCulate:DATA"}, "OFF" par défaut	"CALC:DATA"
Configurez les mesures de résistance et secondaires. Effectuez une mesure de résistance et récupérez la mesure secondaire. CONF:RES AUTO,MAX RES:SEC "CALC:DATA" READ?;DATA2? Réponse type : +3.01566373E-10;,+9.91000000E+3	

- "CALCulate:DATA" - (Concerne uniquement les modèles 34465A et 34470A.) Valeur de mesure précédant toute opération mathématique (notamment l'opération NULL).
- Utilisez la commande **READ?** ou **INITiate** pour lancer la mesure. Utilisez la commande **[SENSe:]DATA2?** pour récupérer la mesure secondaire.
- Ce paramètre est défini à sa valeur par défaut après une réinitialisation de la configuration d'usine (***RST**) ou un pré réglage de l'instrument (**SYSTem:PRESet**).

[SENSe:]RESistance:ZERO:AUTO {OFF|ON|ONCE}

[SENSe:]RESistance:ZERO:AUTO?

Désactive ou active le mode de réglage automatique du zéro pour les mesures de résistance en 2 fils.

- **ON (valeur par défaut)** : le multimètre numérique mesure en interne le décalage après chaque mesure. Il soustrait ensuite cette mesure de la lecture précédente. Cette méthode évite que des tensions de décalage existantes sur le circuit d'entrée de l'instrument ne compromettent la précision de mesure.
- **OFF** : l'instrument utilise la dernière mesure de zéro effectuée et la soustrait de chaque mesure. Il recueille une nouvelle mesure du zéro chaque fois que vous modifiez la fonction, la plage ou le temps d'intégration.
- **ONCE** : l'instrument effectue une mesure du zéro et désactive le réglage automatique du zéro. La mesure du zéro effectuée est utilisée pour toutes les mesures suivantes jusqu'à la prochaine modification de la fonction, de la plage ou du temps d'intégration. Si le temps d'intégration spécifié est inférieur à 1 PLC, la mesure du zéro est effectuée à 1 PLC pour optimiser la réjection du bruit. Les mesures suivantes sont effectuées au temps d'intégration (< 1 PLC) rapide spécifié.

Paramètre	Renvoi type
{OFF ON ONCE}	0 (OFF) ou 1 (ON)
<p>Configurez les mesures de résistance en 2 fils et effectuez immédiatement un réglage automatique du zéro. Effectuez et lisez deux mesures :</p> <pre>CONF:RES 1E4 RES:ZERO:AUTO ONCE SAMP:COUN 2 READ?</pre> <p>Réponse type : +1.04530000E+03,+1.04570000E+03</p>	

- Cette commande n'affecte pas les mesures de résistance en 4 fils, qui sont toujours effectuées avec la fonction de réglage automatique du zéro activée.
- Le mode de réglage automatique du zéro est défini indirectement lorsque vous configurez la résolution et le temps d'intégration à l'aide des commandes **CONFigure:{RESistance|FRESistance}** ou **MEASure:{RESistance|FRESistance}?**. Le réglage automatique du zéro est désactivé automatiquement lorsque vous choisissez un temps d'intégration inférieur à 1 PLC à l'aide de ces commandes.
- Ce paramètre est défini à sa valeur par défaut après une réinitialisation de la configuration d'usine (***RST**) ou un pré-réglage de l'instrument (**SYSTem:PRESet**).

Sous-système [SENSe:]TEMPerature

Ce sous-système configure les mesures de température.

Récapitulatif des commandes

[SENSe:]TEMPerature:APERture

[SENSe:]TEMPerature:APERture:ENABLEd

[SENSe:]TEMPerature:NPLC

[SENSe:]TEMPerature:NULL[:STATe]

[SENSe:]TEMPerature:NULL:VALue

[SENSe:]TEMPerature:NULL:VALue:AUTO

[SENSe:]TEMPerature:SECondary

[SENSe:]TEMPerature:TRANsdncer:{FRTD|RTD}:OCOMpensated

[SENSe:]TEMPerature:TRANsdncer:{FRTD|RTD}:POWER:LIMit[:STATe]

[SENSe:]TEMPerature:TRANsdncer:{FRTD|RTD}:RESistance[:REFerence]

[SENSe:]TEMPerature:TRANsdncer:{FTHermistor|THERmistor}:POWER:LIMit[:STATe]

[SENSe:]TEMPerature:TRANsdncer:{FTHermistor|THERmistor}:TYPE

[SENSe:]TEMPerature:TRANsdncer:TCouple:CHECK

[SENSe:]TEMPerature:TRANsdncer:TCouple:RJUNction

[SENSe:]TEMPerature:TRANsdncer:TCouple:RJUNction:OFFSet:ADJust

[SENSe:]TEMPerature:TRANsdncer:TCouple:RJUNction:TYPE

[SENSe:]TEMPerature:TRANsdncer:TCouple:TYPE

[SENSe:]TEMPerature:TRANsdncer:TYPE

[SENSe:]TEMPerature:ZERO:AUTO

[SENSe:]TEMPerature:APERture {<secondes>|MIN|MAX|DEF}

[SENSe:]TEMPerature:APERture? [{MIN|MAX|DEF}]

Définit le temps d'intégration en secondes (appelé *temps d'ouverture*) pour toutes les mesures de température.

REMARQUE

Utilisez cette commande pour un contrôle précis du temps d'intégration du multimètre numérique. Pour connaître les caractéristiques optimales de réjection de bruit de l'alimentation secteur, utilisez la fonction NPLC (NPLC > 1) (voir [SENSe:]TEMPerature:NPLC).

Paramètre	Renvoi type
(Sans l'option DIG) 200 µs à 1 s (résolution de 2 µs), valeur par défaut : 100 ms. (Avec l'option DIG) 20 µs à 1 s (résolution de 2 µs), valeur par défaut : 100 ms.	+1.00000000E-01
Activer l'ouverture, définir le temps d'ouverture à 300 ms :	
TEMP:APER:ENAB ON TEMP:APER 300E-03	

- Concerne uniquement les modèles 34465A et 34470A.
- Les commandes [SENSe:]<fonction>:NPLC et [SENSe:]<fonction>:APERture contrôlent le temps d'intégration de l'instrument. En cas d'utilisation de ces deux commandes (déconseillée), la commande envoyée pour la dernière fois remplace l'autre commande et définit le temps d'intégration. L'envoi de la commande [SENSe:]<fonction>:APERture entraîne le réglage de la commande [SENSe:]<fonction>:APERture:ENABLEd sur 1 (Activé) ; l'envoi de la commande [SENSe:]<fonction>:NPLC entraîne son réglage sur 0 (Désactivé).
- Ce paramètre est défini à sa valeur par défaut après une réinitialisation de la configuration d'usine (*RST) ou un pré-réglage de l'instrument (SYSTem:PRESet).

[SENSe:]TEMPerature:APERture:ENABLEd {ON|1|OFF|0}

[SENSe:]TEMPerature:APERture:ENABLEd?

Active le réglage du temps d'intégration en secondes (appelé *temps d'ouverture*) pour les mesures de température. Si le mode Temps d'ouverture est désactivé (par défaut), le temps d'intégration est défini en PLC (cycles de tension d'alimentation).

Paramètre	Renvoi type
{ON 1 OFF 0}. Valeur par défaut : OFF.	0 (OFF) ou 1 (ON)
Activer le mode temps d'ouverture, définir le temps d'ouverture à 300 ms :	
TEMP:APER:ENAB ON TEMP:APER 300E-03	

- Concerne uniquement les modèles 34465A et 34470A.
- Les commandes CONFIgure:TEMPerature, MEASure:TEMPerature? et [SENSe:]TEMPerature:NPLC désactivent le mode temps d'ouverture et sélectionnent un temps d'intégration en nombre de cycles de tension d'alimentation.

- Ce paramètre est défini à sa valeur par défaut après une réinitialisation de la configuration d'usine (*RST) ou un pré-réglage de l'instrument (SYSTem:PRESet).

[SENSe:]TEMPerature:NPLC {<PLC>|MIN|MAX|DEF}

[SENSe:]TEMPerature:NPLC? [{MIN|MAX|DEF}]

Définit le temps d'intégration en nombre de cycles de tension d'alimentation (PLC) pour les mesures de température. Le temps d'intégration est la période durant laquelle le convertisseur analogique-numérique (CAN) de l'instrument échantillonne le signal d'entrée pour une mesure. Un temps d'intégration plus long permet d'améliorer la résolution de mesure, mais ralentit la vitesse de mesure.

Paramètre	Renvoi type
0,02 ; 0,2 ; 1 ; 10 ; 100. Valeur par défaut : 10 (34460A/61A) 0,02 ; 0,06 ; 0,2 ; 1 ; 10 ; 100. Valeur par défaut : 10 (34465A/70A sans option DIG) 0,001 ; 0,002 ; 0,006 ; 0,02 ; 0,06 ; 0,2 ; 1 ; 10 ; 100. Valeur par défaut : 10 (34465A/70A avec l'option DIG) Pour de plus amples informations, reportez-vous à la section Plage, résolution et NPLC .	+1.00000000E+01
<p>Configurez les mesures de RTD en 4 fils avec un temps d'intégration de 10 PLC. Puis, effectuez et lisez une mesure :</p> <pre>CONF:TEMP FRTD TEMP:NPLC 10 READ?</pre> <p>Réponse type : +6.27530000E+01</p>	

- La sélection d'un temps d'intégration en cycles d'alimentation remplace une ouverture définie avec la commande [SENSe:]TEMPerature:APERture.
- Seuls les temps d'intégration de 1, 10 et 100 PLC permettent une réjection (du bruit de fréquence réseau) en mode normal.
- Le réglage du temps d'intégration entraîne également celui de la résolution de mesure. Le **tableau de résolution** décrit le rapport entre le temps d'intégration et la résolution.
- Ce paramètre est défini à sa valeur par défaut après une réinitialisation de la configuration d'usine (*RST) ou un pré-réglage de l'instrument (SYSTem:PRESet).

[SENSe:]TEMPerature:NULL[:STATe] {ON|1|OFF|0}
 [SENSe:]TEMPerature:NULL[:STATe]?

Active ou désactive la fonction de mesure par rapport à une référence pour les mesures de température.

Paramètre	Renvoi type
{ON 1 OFF 0}. Valeur par défaut : OFF.	0 (OFF) ou 1 (ON)
Configurez les mesures de RTD en 4 fils à l'aide de la fonction de mesure par rapport à une référence pour soustraire 25°. Effectuez et lisez deux mesures : CONF:TEMP RTD TEMP:NULL:STAT ON VAL 25;SAMP:COUN 2 READ? Réponse type : +1.04530000E+00,+1.04570000E+00	

- L'activation de la fonction de réglage d'échelle entraîne également celle de la sélection automatique de la valeur de référence ([SENSe:]TEMPerature:NULL:VALue:AUTO ON).
- Pour définir une valeur de référence fixe, utilisez la commande suivante : [SENSe:]TEMPe-rature:NULL:VALue.
- L'instrument désactive la fonction de mesure par rapport à une référence après une réinitialisation de la configuration d'usine (*RST), un pré-réglage de l'instrument (SYSTem:PRESet) ou l'exécution de la fonction CONFigure.

[SENSe:]TEMPerature:NULL:VALue {<valeur>|MIN|MAX|DEF}
 [SENSe:]TEMPerature:NULL:VALue? [{MIN|MAX|DEF}]

Enregistre une valeur de référence pour les mesures de température.

Paramètre	Renvoi type
-1.0E15 à +1.0E15. Valeur par défaut : 0.	+2.50000000E+01
Configurez les mesures de RTD en 4 fils à l'aide de la fonction de mesure par rapport à une référence pour soustraire 25°. Effectuez et lisez deux mesures : CONF:TEMP RTD TEMP:NULL:STAT ON VAL 25;SAMP:COUN 2 READ? Réponse type : +1.04530000E+00,+1.04570000E+00	

- La saisie d'une valeur de référence entraîne la désactivation de la sélection automatique de la valeur de référence ([SENSe:]TEMPerature:NULL:VALue:AUTO OFF).
- Pour utiliser la valeur de référence, l'état Null doit être activé ([SENSe:]TEMPerature:NULL:STATe ON).
- Ce paramètre est défini sur sa valeur par défaut après une réinitialisation de la configuration d'usine (*RST), un pré-réglage de l'instrument (SYSTem:PRESet) ou l'exécution de la fonction CONFigure.

[SENSe:]TEMPerature:NULL:VALue:AUTO {ON|1|OFF|0}
[SENSe:]TEMPerature:NULL:VALue:AUTO?

Active ou désactive la sélection automatique de la valeur de référence pour toutes les mesures de température.

Paramètre	Renvoi type
{ON 1 OFF 0}. Valeur par défaut : OFF.	0 (OFF) ou 1 (ON)
Configurez les mesures de température à l'aide de la fonction de mesure par rapport à une référence pour soustraire 25° de ces dernières. Effectuez et lisez deux mesures : CONF:TEMP RTD TEMP:NULL:STAT ON;VAL 25> SAMP:COUN 2 READ? Réponse type : +1.04530000E+00,+1.04570000E+00 Effectuer un deuxième jeu de mesures à l'aide de la fonction de sélection automatique de la valeur de référence : TEMP:NULL:VAL:AUTO ON READ? Réponse type : +0.00000000E+00,+0.01420000E+00	

- Lorsque la sélection de référence automatique est activée, la première mesure effectuée est utilisée comme valeur de référence pour toutes les mesures suivantes. La commande **[SENSe:]TEMPerature:NULL:VALue** est réglée sur cette valeur. La sélection automatique de la valeur de référence sera désactivée.
- Lorsque la sélection automatique de la valeur de référence est désactivée (OFF), la valeur de référence est spécifiée par la commande suivante : **[SENSe:]TEMPerature:NULL:VALue**.
- L'instrument active la sélection automatique de la valeur de référence lorsque la fonction de mesure par rapport à une référence est activée (**[SENSe:]TEMPerature:NULL:STATe ON**).
- Ce paramètre est défini sur sa valeur par défaut après une réinitialisation de la configuration d'usine (***RST**), un pré réglage de l'instrument (**SYSTem:PRESet**) ou l'exécution de la fonction **CONFigure**.

[SENSe:]TEMPerature:SEConDary {"OFF"|"CALCulate:DATA"|"SENSe:DATA"}
 [SENSe:]TEMPerature:SEConDary?

Sélectionne la fonction de mesure secondaire pour les mesures de température.

Paramètre	Renvoi type
{"OFF" "CALCulate:DATA" "SENSe:DATA"}, "OFF" par défaut	"CALC:DATA"
Configurez une mesure de RTD en 4 fils. Sélectionnez la valeur de capteur brute (ohms dans cet exemple) comme mesure secondaire. Effectuez et récupérez des mesures. CONF:TEMP FRTD,85 TEMP:SEC "SENS:DATA" READ?;DATA2? Réponse type : -6.95327319E-01;+9.97282173E+01	

- "CALCulate:DATA" - (Concerne uniquement les modèles 34465A et 34470A.) Valeur de mesure précédant toute opération mathématique (notamment l'opération NULL).
- « SENSe:DATA » est la valeur de capteur brute ; résistance de thermistance/RTD, tension et température de référence du thermocouple (les mesures par thermocouples concernent uniquement les modèles 34465A et 34470A).
- Utilisez la commande **READ?** ou **INITiate** pour lancer la mesure.
- Ce paramètre est défini à sa valeur par défaut après une réinitialisation de la configuration d'usine (***RST**) ou un pré réglage de l'instrument (**SYSTem:PRESet**).

[SENSe:]TEMPerature:TRANsducer:{FRTD|RTD}:OCOMPensated {ON|1|OFF|0}
 [SENSe:]TEMPerature:TRANsducer:{FRTD|RTD}:OCOMPensated?

Active ou désactive la compensation de décalage pour les mesures de RTD en 2 ou 4 fils.

La compensation de décalage supprime les effets de toutes les tensions continues dans le circuit mesuré. La méthode consiste à recueillir la différence entre deux mesures de résistance, une avec la source de courant réglée sur la valeur normale et l'autre avec la source de courant réglée sur une valeur inférieure.

REMARQUE Ce paramètre est commun aux mesures de résistance en 2 et 4 fils. La version FRTD de cette commande ou requête est identique à la version RTD.

Paramètre	Renvoi type
{ON 1 OFF 0}. Valeur par défaut : OFF.	0 (OFF) ou 1 (ON)
Configurez des mesures de RTD en 2 fils à compensation de décalage. Effectuez et lisez deux mesures : CONF:TEMP RTD TEMP:TRANS:RTD:POW:LIM ON TEMP:TRANS:RTD:OCOM ON SAMP:COUN 2 READ? Réponse type : +1.05451008E+01,+1.07391062E+01	

- Concerne uniquement les modèles 34465A et 34470A.
- Concerne uniquement les mesures de résistance en 2 et 4 fils.
- Ce paramètre est défini à sa valeur par défaut après une réinitialisation de la configuration d'usine (*RST) ou un pré-réglage de l'instrument (SYSTem:PRESet).

[SENSe:]TEMPerature:TRANsducer:{FRTD|RTD}:POWer:LIMit[:STATe] {ON|1|OFF|0}
 [SENSe:]TEMPerature:TRANsducer:{FRTD|RTD}:POWer:LIMit[:STATe]?

Active ou désactive les mesures de RTD en 2 ou 4 fils de basse puissance.

REMARQUE Ce paramètre est commun aux mesures de RTD en 2 et 4 fils. La version du FRTD de cette commande ou requête est identique à la version du RTD.

Paramètre	Renvoi type
{ON 1 OFF 0}. Valeur par défaut : OFF.	0 (OFF) ou 1 (ON)
Configurez des mesures de RTD en 2 fils à compensation de décalage. Effectuez et lisez deux mesures : CONF:TEMP RTD TEMP:TRANS:RTD:POW:LIM ON TEMP:TRANS:RTD:OCOM ON SAMP:COUN 2 READ? Réponse type : +1.05451008E+01,+1.07391062E+01	

- Concerne uniquement les modèles 34465A et 34470A.
- Ce paramètre est défini à sa valeur par défaut après une réinitialisation de la configuration d'usine (*RST) ou un préreglage de l'instrument (SYSTem:PRESet).

[SENSe:]TEMPerature:TRANsducer:{FRTD|RTD}:RESistance[:REFerence] {<référence>|MIN|MAX|DEF}
 [SENSe:]TEMPerature:TRANsducer:{FRTD|RTD}:RESistance[:REFerence]? [{MIN|MAX|DEF}]

Sélectionne la résistance nominale (R_0) pour les mesures de RTD en 2 et 4 fils. R_0 correspond à la résistance nominale d'un RTD à 0 °C.

Paramètre	Renvoi type
34460A/61A : 80 Ω à 120 kΩ. Valeur par défaut : 100 Ω. 34465A/70A : 49 Ω à 2100 kΩ. Valeur par défaut : 100 Ω.	+1.00100000E+02
Configurez les mesures de RTD en 4 fils avec un RTD ayant une valeur R_0 de 100,1 Ω. Effectuez et lisez deux mesures : CONF:TEMP FRTD TEMP:TRAN:FRTD:RES 100.1 SAMP:COUN 2 READ? Réponse type : +1.04530000E+02,+1.04570000E+02	

- Ce paramètre est défini à sa valeur par défaut après une réinitialisation de la configuration d'usine (*RST) ou un préreglage de l'instrument (SYSTem:PRESet).

[SENSe:]TEMPerature:TRANsducer:{FTHermistor|THERmistor}:POWer:LIMit[:STATe] {ON|1|OFF|0}
 [SENSe:]TEMPerature:TRANsducer:{FTHermistor|THERmistor}:POWer:LIMit[:STATe]?

Active ou désactive les mesures de thermistance de basse puissance (2 ou 4 fils).

Paramètre	Renvoi type
{ON 1 OFF 0}. Valeur par défaut : OFF.	0 (OFF) ou 1 (ON)
Configurez les mesures de thermistance en 4 fils. Activez les mesures de thermistance en 4 fils de basse puissance. Effectuez et lisez deux mesures : CONF:TEMP FTH TEMP:TRAN:FTH:TYPE 5000 TEMP:TRAN:FTH:POW:LIM ON SAMP:COUN 2 READ? Réponse type : +1.04530000E+02,+1.04570000E+02	

- Concerne uniquement les modèles 34465A et 34470A.
- Seuls les temps d'intégration de 1, 10 et 100 PLC permettent une réjection (du bruit de fréquence réseau) en mode normal.
- Le réglage du temps d'intégration entraîne également celui de la résolution de mesure. Le **tableau de résolution** décrit le rapport entre le temps d'intégration et la résolution.
- Ce paramètre est défini à sa valeur par défaut après une réinitialisation de la configuration d'usine (*RST) ou un préréglage de l'instrument (SYSTem:PRESet).

[SENSe:]TEMPerature:TRANsducer:TYPE {FRTD|RTD|FTHermistor|THERmistor|TCouple}

[SENSe:]TEMPerature:TRANsducer:TYPE?

Sélectionne le type de sonde de capteur à utiliser pour les mesures de température. Les sondes prises en charge sont des RTD en 2 et 4 fils, des thermistances en 2 et 4 fils (type 44004 de 2,2 kΩ , 44007 de 5 kΩ et 44006 de 10 kΩ ,voir les **Exigences relatives aux thermistances**) et, pour le 34465A/70A uniquement, des thermocouples de type E, J, K, N, R ou T.

Paramètre	Renvoi type
{FRTD RTD FTHermistor THERmistor TCouple}. Valeur par défaut : FRTD.	FRTD, RTD, FTH, TC ou THER
Configurez les mesures de RTD en 2 fils avec un RTD ayant une valeur R_0 de 100,1 Ω. Effectuez et lisez deux mesures : FUNC "TEMP" TEMP:TRAN:TYPE RTD TEMP:TRAN:FRTD:RES 100.1 SAMP:COUN 2 READ? Réponse type : +2.54530000E+01,+2.54570000E+01	

- TCouple concerne uniquement les modèles 34465A et 34470A.
- Ce paramètre est défini à sa valeur par défaut après une réinitialisation de la configuration d'usine (*RST) ou un pré réglage de l'instrument (SYSTem:PRESet).

[SENSe:]TEMPerature:TRANsducer:TCouple:CHECK {ON|1|OFF|0}

[SENSe:]TEMPerature:TRANsducer:TCouple:CHECK?

Désactive ou active la fonction de *vérification des thermocouples* pour vérifier que vos thermocouples sont correctement connectés pour les mesures. Lorsque cette fonction est activée, l'instrument mesure la résistance après chaque mesure par thermocouple pour garantir une connexion adéquate. Si une connexion ouverte est détectée (supérieure à 5 kΩ sur la plage 10 kΩ), l'instrument signale une condition de surcharge.

Paramètre	Renvoi type
{ON 1 OFF 0}. Valeur par défaut : OFF.	0 (OFF) ou 1 (ON)
Configurez les mesures par thermocouples de type K. Sélectionnez une jonction de référence fixe et réglez la température de jonction de référence à +20 °C. Activez la vérification des thermocouples. Effectuez et lisez deux mesures : CONF:TEMP TC,K TEMP:TRAN:TC:RJUN:TYPE FIX TEMP:TRAN:TC:RJUN 20.0 TEMP:TRAN:TC:CHEC ON SAMP:COUN 2 READ? Réponse type : +3.31785468E+00,+3.61554515E+00	

- Concerne uniquement les modèles 34465A et 34470A.
- L'activation de la fonction de vérification des thermocouples réduit les vitesses de mesure car deux mesures doivent être effectuées pour chaque valeur de mesure de température générée.
- Ce paramètre est défini à sa valeur par défaut après une réinitialisation de la configuration d'usine (*RST) ou un pré réglage de l'instrument (SYSTem:PRESet).

[SENSe:]TEMPerature:TRANsducer:TCouple:RJUNction {<température>|MIN|MAX|DEF}

[SENSe:]TEMPerature:TRANsducer:TCouple:RJUNction? [{MIN|MAX|DEF}]

Sélectionne la température de jonction de référence fixe en degrés Celsius pour les mesures par thermocouples.

Paramètre	Renvoi type
-20 °C à +80 °C. Valeur par défaut : 0 °C.	+2.00000000E+01 (toujours en degrés Celsius).
<p>Configurez les mesures par thermocouples de type K. Sélectionnez une jonction de référence fixe et réglez la température de jonction de référence à +20 °C. Activez la vérification des thermocouples. Effectuez et lisez deux mesures :</p> <pre>CONF:TEMP TC,K TEMP:TRAN:TC:RJUN:TYPE FIX TEMP:TRAN:TC:RJUN 20.0 TEMP:TRAN:TC:CHEC ON SAMP:COUN 2 READ?</pre> <p>Réponse type : +3.31785468E+00,+3.61554515E+00</p>	

- Concerne uniquement les modèles 34465A et 34470A.
- Pour cette commande, vous devez toujours spécifier la température en degrés Celsius, quelles que soient les unités de température actuellement sélectionnées (voir la commande UNIT:TEMPerature).
- Ce paramètre est défini à sa valeur par défaut après une réinitialisation de la configuration d'usine (*RST) ou un pré réglage de l'instrument (SYSTem:PRESet).

[SENSe:]TEMPerature:TRANsducer:TCouple:RJUNction:OFFSet:ADJJust { <température>|MIN|MAX|DEF}
 [SENSe:]TEMPerature:TRANsducer:TCouple:RJUNction:OFFSet:ADJJust? [{MIN|MAX|DEF}]

Vous permet d'apporter des ajustements mineurs à la température pour corriger les différences entre la mesure de température interne de la connexion avant du multimètre numérique et la température réelle des bornes de mesures.

Paramètre	Renvoi type
-20 °C à +20 °C. Valeur par défaut : 0 °C.	+2.00000000E+01
Configurez les mesures de température par thermocouples à l'aide de la jonction de référence interne. Mesurez la température à l'intérieur de l'instrument. Supposons que la température extérieure à l'instrument soit plus froide de 5 °C que celle de la partie intérieure. Réglez la température de -5 °C. Puis, effectuez et lisez une mesure : CONF:TEMP TC,K TEMP:TRAN:TC:RJUN:TYPE INT TEMP:TRAN:TC:CHEC ON SYST:TEMP? TEMP:TRAN:TC:RJUN:OFFS:ADJ -5 READ? Réponse type : +3.31785468E+00	

- Concerne uniquement les modèles 34465A et 34470A.
- **Important** : La température de référence interne étant égale à celle des connexions *avant*, l'utilisation des connexions *arrière* avec la sélection de la jonction de référence interne générera une erreur inconnue sans aucune performance spécifiée et est déconseillée.
- Ce paramètre est défini à sa valeur par défaut après une réinitialisation de la configuration d'usine (***RST**) ou un pré réglage de l'instrument (**SYSTem:PRESet**).

[SENSe:]TEMPerature:TRANsducer:TCouple:RJUNction:TYPE {INTernal|FIXed}

[SENSe:]TEMPerature:TRANsducer:TCouple:RJUNction:TYPE?

Les mesures par thermocouples requièrent une température de jonction de référence. Pour la température de jonction de référence, vous pouvez utiliser une mesure *interne* ou une température de jonction externe *fixe* connue. Cette commande sélectionne la source de jonction de référence pour les mesures par thermocouples.

Paramètre	Renvoi type
{FIXed INTernal}, INT par défaut	FIX ou INT
Configurez les mesures par thermocouples de type K. Sélectionnez une jonction de référence fixe et réglez la température de jonction de référence à +20 °C. Activez la vérification des thermocouples. Effectuez et lisez deux mesures : CONF:TEMP TC,K TEMP:TRAN:TC:RJUN:TYPE FIX TEMP:TRAN:TC:RJUN 20.0 TEMP:TRAN:TC:CHEC ON SAMP:COUN 2 READ? Réponse type : +3.31785468E+00,+3.61554515E+00	

- Concerne uniquement les modèles 34465A et 34470A.
- **Important** : La température de référence interne étant égale à celle des connexions *avant*, l'utilisation des connexions *arrière* avec la sélection de la jonction de référence interne génèrera une erreur inconnue sans aucune performance spécifiée et est déconseillée.
- La précision de la mesure dépend fortement des connexions du thermocouple et du type de jonction de référence utilisé. Utilisez une référence de mesure *fixe* pour les mesures de haute précision (vous devez conserver la température de jonction connue).
- Si vous sélectionnez une température de référence *fixe*, saisissez une valeur comprise entre -20 °C et +80 °C à l'aide de la commande [Sense:]TEMPerature:TRANsducer:TCouple:RJUNction. Vous devez toujours spécifier la température en degrés Celsius, quelles que soient les unités de température actuellement sélectionnées (voir la commande UNIT:TEMPerature).
- Vous pouvez lire la température de jonction de référence interne à l'aide la commande SYSTem:TEMPerature.
- Ce paramètre est défini à sa valeur par défaut après une réinitialisation de la configuration d'usine (*RST) ou un pré réglage de l'instrument (SYSTem:PRESet).

[SENSe:]TEMPerature:TRANsducer:TCouple:TYPE {E|J|K|N|R|T}

[SENSe:]TEMPerature:TRANsducer:TCouple:TYPE?

Sélectionne la source de jonction de référence pour les mesures par thermocouples.

Paramètre	Renvoi type
{E J K N R T}, J par défaut	E, J, K, N, R ou T
<p>Configurez les mesures par thermocouples de type K. Sélectionnez une jonction de référence fixe et réglez la température de jonction de référence à +20 °C. Activez la vérification des thermocouples. Effectuez et lisez deux mesures :</p> <p>CONF:TEMP TC,K TEMP:TRAN:TC:RJUN:TYPE FIX TEMP:TRAN:TC:RJUN 20.0 TEMP:TRAN:TC:CHEC ON SAMP:COUN 2 READ?</p> <p>Réponse type : +3.31785468E+00,+3.61554515E+00</p>	

- Concerne uniquement les modèles 34465A et 34470A.
- Les mesures par thermocouples requièrent une température de jonction de référence (voir la commande [SENSe:]TEMPerature:TRANsducer:TCouple:RJUNction:TYPE). Pour la température de jonction de référence, vous pouvez utiliser une mesure *interne* ou une température de jonction *fixe* connue. Par défaut, une température de jonction de référence interne est utilisée.
- Ce paramètre est défini à sa valeur par défaut après une réinitialisation de la configuration d'usine (*RST) ou un pré réglage de l'instrument (SYSTem:PRESet).

[SENSe:]TEMPerature:TRANsducer:{FTHermistor|THERmistor}:TYPE 5000

[SENSe:]TEMPerature:TRANsducer:{FTHermistor|THERmistor}:TYPE?

Sélectionne le type de thermistance pour les mesures de température en 2 et 4 fils. Le choix de la commande THERmistor ou FTHermistor importe peu, car les deux commandes concernent le même paramètre.

Paramètre	Renvoi type
5000 (seul choix disponible)	+5000
<p>Configurez les mesures de thermistance en 4 fils. Effectuez et lisez deux mesures :</p> <p>CONF:TEMP FTH TEMP:TRAN:FTH:TYPE 5000 SAMP:COUN 2 READ?</p> <p>Réponse type : +1.04530000E+02,+1.04570000E+02</p>	

[SENSe:]TEMPerature:ZERO:AUTO {OFF|ON|ONCE}

[SENSe:]TEMPerature:ZERO:AUTO?

Désactive ou active le mode de réglage automatique du zéro pour les mesures de température à 2 fils.

- **ON (valeur par défaut)** : le multimètre numérique mesure en interne le décalage après chaque mesure. Il soustrait ensuite cette mesure de la lecture précédente. Cette méthode évite que des tensions de décalage existantes sur le circuit d'entrée de l'instrument ne compromettent la précision de mesure.
- **OFF** : l'instrument utilise la dernière mesure de zéro effectuée et la soustrait de chaque mesure. Il recueille une nouvelle mesure du zéro chaque fois que vous modifiez la fonction, la plage ou le temps d'intégration.
- **ONCE** : l'instrument effectue une mesure du zéro et désactive le réglage automatique du zéro. La mesure du zéro effectuée est utilisée pour toutes les mesures suivantes jusqu'à la prochaine modification de la fonction, de la plage ou du temps d'intégration. Si le temps d'intégration spécifié est inférieur à 1 PLC, la mesure du zéro est effectuée à 1 PLC pour optimiser la réjection du bruit. Les mesures suivantes sont effectuées au temps d'intégration (< 1 PLC) rapide spécifié.

Paramètre	Renvoi type
{OFF ON ONCE}. Valeur par défaut : ON.	0 (OFF) ou 1 (ON)
Configurez les mesures de RTD en 2 fils et effectuez immédiatement un réglage automatique du zéro. Effectuez et lisez deux mesures : CONF:TEMP RTD TEMP:ZERO:AUTO ONCE SAMP:COUN 2 READ? Réponse type : +2.57530000E+01,+2.57570000E+01	

- Cette commande n'affecte pas les mesures de résistance en 4 fils, qui sont toujours effectuées avec la fonction de réglage automatique du zéro activée.
- Le mode de réglage automatique du zéro est défini indirectement lorsque vous configurez la résolution et le temps d'intégration à l'aide des commandes **CONFigure:TEMPerature** ou **MEASure:TEMPerature?**. Le réglage automatique du zéro est désactivé automatiquement lorsque vous choisissez un temps d'intégration inférieur à 1 PLC à l'aide de ces commandes.
- Ce paramètre est défini à sa valeur par défaut après une réinitialisation de la configuration d'usine (***RST**) ou un pré-réglage de l'instrument (**SYSTem:PRESet**).

Sous-système [SENSe:]VOLTage

Ce sous-système configure les mesures en tension alternative, en tension continue et du rapport de tension continue.

Récapitulatif des commandes

[SENSe:]VOLTage:AC:BANDwidth
[SENSe:]VOLTage:{AC|DC}:NULL[:STATe]
[SENSe:]VOLTage:{AC|DC}:NULL:VALue
[SENSe:]VOLTage:{AC|DC}:NULL:VALue:AUTO
[SENSe:]VOLTage:{AC|DC}:RANGe
[SENSe:]VOLTage:{AC|DC}:RANGe:AUTO
[SENSe:]VOLTage:AC:SECondary
[SENSe:]VOLTage[:DC]:APERture
[SENSe:]VOLTage[:DC]:APERture:ENABled
[SENSe:]VOLTage[:DC]:IMPedance:AUTO
[SENSe:]VOLTage[:DC]:NPLC
[SENSe:]VOLTage[:DC]:RATio:SECondary
[SENSe:]VOLTage[:DC]:RESolution
[SENSe:]VOLTage[:DC]:SECondary
[SENSe:]VOLTage[:DC]:ZERO:AUTO

[SENSe:]VOLTage:AC:BANDwidth {<filtre>|MIN|MAX|DEF}
 [SENSe:]VOLTage:AC:BANDwidth? [{MIN|MAX|DEF}]

Définit la bande passante pour les mesures en tension alternative.

L'instrument utilise trois filtres de courant alternatif différents qui vous permettent d'optimiser la précision en basse fréquence ou de réduire les temps de stabilisation en courant alternatif suite à une variation de l'amplitude du signal d'entrée. L'instrument sélectionne le filtre lent (3 Hz), moyen (20 Hz) ou rapide (200 Hz) selon la fréquence de coupure spécifiée par cette commande. Spécifiez la fréquence la plus basse attendue.

Paramètre	Renvoi type
{3 Hz 20 Hz 200 Hz}. Valeur par défaut : 20 Hz.	+2.00000000E+01
Effectuez et lisez une mesure en tension alternative. Utilisez la bande passante de filtre 3 Hz : CONF:VOLT:AC 100 VOLT:AC:BAND 3 READ?	

- Si vous saisissez la fréquence la plus basse attendue, la commande sélectionnera le <filtre> approprié. Par exemple, si vous saisissez 15 Hz, le filtre lent (3 Hz) est sélectionné. Si vous saisissez 190 Hz, le filtre moyen (20 Hz) est sélectionné pour fournir la fréquence de coupure basse appropriée.
- Définissez la fréquence la plus basse que vous espérez trouver. Les bandes passantes inférieures produisent des délais de stabilisation plus longs, comme indiqué ci-dessous :

Fréquence d'entrée	Délai de stabilisation par défaut
3 Hz - 300 kHz (<i>lent</i>)	2,5000 s/mesure
20 Hz - 300 kHz (<i>moyen</i>)	0,6250 s/mesure
200 Hz - 300 kHz (<i>rapide</i>)	0,0250 s/mesure

- Ce paramètre est défini à sa valeur par défaut après une réinitialisation de la configuration d'usine (*RST) ou un pré-réglage de l'instrument (SYSTem:PRESet).

[SENSe:]VOLTage:{AC|DC}:NULL[:STATe] {ON|1|OFF|0}
 [SENSe:]VOLTage:{AC|DC}:NULL[:STATe]?

Active ou désactive la fonction de mesure par rapport à une référence pour les mesures en tension alternative ou en tension continue.

REMARQUE Ce paramètre n'est pas commun aux mesures en courant alternatif et courant continu. Les paramètres sont distincts pour les mesures en courant alternatif et courant continu.

Paramètre	Renvoi type
{ON 1 OFF 0}. Valeur par défaut : OFF.	0 (OFF) ou 1 (ON)
Configurez les mesures en tension alternative à l'aide de la fonction de mesure par rapport à une référence pour soustraire 100 mV des mesures. Effectuez et lisez deux mesures : CONF:VOLT:AC VOLT:AC:NULL:STAT ON;VAL 100 mV SAMP:COUN 2 READ? Réponse type : +1.04530000E+00,+1.04570000E+00	

- L'activation de la fonction de réglage d'échelle entraîne également celle de la sélection automatique de la valeur de référence ([SENSe:]VOLTage:{AC|DC}:NULL:VALue:AUTO ON).
- Pour définir une valeur de référence fixe, utilisez la commande suivante : [SENSe:]VOLTage:{AC|DC}:NULL:VALue.
- La fonction de mesure par rapport à une référence n'est pas disponible pour les mesures du rapport de tension continue.
- L'instrument désactive la fonction de mesure par rapport à une référence après une réinitialisation de la configuration d'usine (*RST), un pré-réglage de l'instrument (SYSTem:PRESet) ou l'exécution de la fonction CONFIGure.

[SENSe:]VOLTage:{AC|DC}:NULL:VALue {<valeur>|MIN|MAX|DEF}
 [SENSe:]VOLTage:{AC|DC}:NULL:VALue? [{MIN|MAX|DEF}]

Enregistre une valeur de référence pour les mesures de tension.

REMARQUE Ce paramètre n'est pas commun aux mesures en courant alternatif et courant continu. Les paramètres sont distincts pour les mesures en courant alternatif et courant continu.

Paramètre	Renvoi type
-1 200 à +1 200 V, Valeur par défaut : 0.	+1.00000000E-02
Configurez les mesures en tension alternative à l'aide de la fonction de mesure par rapport à une référence pour soustraire 100 mV des mesures. Effectuez et lisez deux mesures : CONF:VOLT:AC VOLT:AC:NULL:STAT ON;VAL 100 mV SAMP:COUN 2 READ? Réponse type : +1.04530000E+00,+1.04570000E+00	

- La saisie d'une valeur de référence entraîne la désactivation de la sélection automatique de la valeur de référence ([SENSe:]VOLTage:{AC|DC}:NULL:VALue:AUTO OFF).
- Pour utiliser la valeur de référence, l'état Null doit être activé ([SENSe:]VOLTage:{AC|DC}:NULL:STATe ON).
- La fonction de mesure par rapport à une référence n'est pas disponible pour les mesures du rapport de tension continue.
- Ce paramètre est défini sur sa valeur par défaut après une réinitialisation de la configuration d'usine (*RST), un pré réglage de l'instrument (SYSTem:PRESet) ou l'exécution de la fonction CONFigure.

[SENSe:]VOLTage:{AC|DC}:NULL:VALue:AUTO {ON|1|OFF|0}
[SENSe:]VOLTage:{AC|DC}:NULL:VALue:AUTO?

Active ou désactive la sélection automatique de la valeur de référence pour les mesures en tension alternative ou en tension continue.

REMARQUE Ce paramètre n'est pas commun aux mesures en courant alternatif et courant continu. Les paramètres sont distincts pour les mesures en courant alternatif et courant continu.

Paramètre	Renvoi type
{ON 1 OFF 0}. Valeur par défaut : OFF.	0 (OFF) ou 1 (ON)
<p>Configurez les mesures en tension alternative à l'aide de la fonction de mesure par rapport à une référence pour soustraire 100 mV des mesures. Effectuez et lisez deux mesures :</p> <pre>CONF:VOLT:AC VOLT:AC:NULL:STAT ON;VAL 100 mV SAMP:COUN 2 READ?</pre> <p>Réponse type : +1.04530000E+00,+1.04570000E+00</p> <p>Effectuer un deuxième jeu de mesures à l'aide de la fonction de sélection automatique de la valeur de référence :</p> <pre>VOLT:AC:NULL:VAL:AUTO ON READ?</pre> <p>Réponse type : +0.00000000E+00,+0.01420000E+00</p>	

- Lorsque la sélection de référence automatique est activée, la première mesure effectuée est utilisée comme valeur de référence pour toutes les mesures suivantes. La commande **[SENSe:]VOLTage:{AC|DC}:NULL:VALue** est réglée sur cette valeur. La sélection automatique de la valeur de référence sera désactivée.
- Lorsque la sélection automatique de la valeur de référence est désactivée (OFF), la valeur de référence est spécifiée par la commande suivante : **[SENSe:]VOLTage:{AC|DC}:NULL:VALue**.
- L'instrument active la sélection automatique de la valeur de référence lorsque la fonction de mesure par rapport à une référence est activée (**[SENSe:]VOLTage:{AC|DC}:NULL:STATe ON**).
- La fonction de mesure par rapport à une référence n'est pas disponible pour les mesures du rapport de tension continue.
- Ce paramètre est défini sur sa valeur par défaut après une réinitialisation de la configuration d'usine (***RST**), un pré-réglage de l'instrument (**SYSTem:PRESet**) ou l'exécution de la fonction **CONFigure**.

[SENSe:]VOLTage:{AC|DC}:RANGe {<plage>|MIN|MAX|DEF}
 [SENSe:]VOLTage:{AC|DC}:RANGe? [{MIN|MAX|DEF}]

Sélectionne une plage de mesure fixe pour les mesures en tension alternative et en tension continue et les mesures du rapport de tension continue.

REMARQUE Ce paramètre n'est pas commun aux mesures en courant alternatif et courant continu. Les paramètres sont distincts pour les mesures en courant alternatif et courant continu.

AVERTISSEMENT Le paramètre de plage maximal (MAX) est de 1 000 V. Cependant, la LIMITE DE SÉCURITÉ sur les bornes d'entrée HI/LO avant et arrière est de 750 Vca (eff.). La tension efficace vraie dépend du signal. Une onde sinusoïdale est limitée à 750 Vca (eff.), mais une onde carrée de 1 000 V crête est sûre. La connexion à l'alimentation secteur est en outre limitée à la catégorie de mesure II (300 V). Pour de plus amples informations sur les fonctions de sécurité et l'utilisation sans danger de cet instrument, reportez-vous à la section **Informations de sécurité et réglementaires**.

Paramètre	Renvoi type
<plage> : {100 mV 1 V 10 V 100 V 1 000 V} Courant alternatif par défaut : 10 V Courant continu par défaut : 1 000 V	+1.00000000E+01
Configurez les mesures en tension alternative avec la plage de 100 V. Effectuez et lisez deux mesures : CONF:VOLT:AC VOLT:AC:RANG 100 SAMP:COUN 2 READ? Réponse type : +3.24530000E+01,+3.24570000E+01	

- La sélection d'une plage fixe ([SENSe:]<fonction>:RANGe) entraîne la désactivation de la commutation automatique de plage.
- Si le signal d'entrée est supérieur au signal pouvant être mesuré dans la plage manuelle spécifiée, l'instrument affiche l'indication *Overload* (Surcharge) sur le panneau avant et renvoie « 9.9E37 » depuis l'interface de commande à distance.
- L'instrument est défini sur la plage par défaut et la commutation automatique est activée ([SENSe:]VOLTage:{AC|DC}:RANGe:AUTO ON), après un rétablissement des réglages d'usine (*RST) ou un préréglage de l'instrument (SYSTem:PRESet).

[SENSe:]VOLTage:{AC|DC}:RANGe:AUTO {OFF|ON|ONCE}
 [SENSe:]VOLTage:{AC|DC}:RANGe:AUTO?

Désactive/active la commutation automatique pour les mesures en tensions alternative et continue, et les mesures du rapport de tension continue. La commutation automatique de plage est pratique car l'instrument sélectionne automatiquement la plage pour chaque mesure en fonction du signal d'entrée.

La saisie de ONCE entraîne immédiatement la commutation automatique de plage, puis la désactivation de la commutation automatique.

REMARQUE Ce paramètre n'est pas commun aux mesures en courant alternatif et courant continu. Les paramètres sont distincts pour les mesures en courant alternatif et courant continu.

AVERTISSEMENT Le paramètre de plage maximal (MAX) est de 1 000 V. Cependant, la LIMITE DE SÉCURITÉ sur les bornes d'entrée HI/LO avant et arrière est de 750 Vca (eff.). La tension efficace vraie dépend du signal. Une onde sinusoïdale est limitée à 750 Vca (eff.), mais une onde carrée de 1 000 V crête est sûre. La connexion à l'alimentation secteur est en outre limitée à la catégorie de mesure II (300 V). Pour de plus amples informations sur les fonctions de sécurité et l'utilisation sans danger de cet instrument, reportez-vous à la section **Informations de sécurité et réglementaires**.

Paramètre	Renvoi type
{ON 1 OFF 0}. Valeur par défaut : ON.	0 (OFF) ou 1 (ON)
Configurez les mesures en tension continue et effectuez immédiatement une commutation automatique de plage. Effectuez et lisez deux mesures : CONF:VOLT:AC VOLT:AC:RANG:AUTO ONCE SAMP:COUN 2 READ? Réponse type : +1.04530000E+01,+1.04570000E+01	

- La commutation automatique de plage descend d'une plage à moins de 10 % de la plage et augmente d'une plage à plus de 120 % de la plage.
- Lorsque la commutation automatique de plage est activée, l'instrument sélectionne la plage en fonction du signal d'entrée.
- La sélection d'une plage fixe ([SENSe:]<fonction>:RANGe) entraîne la désactivation de la commutation automatique de plage.
- Ce paramètre est défini à sa valeur par défaut après une réinitialisation de la configuration d'usine (*RST) ou un préreglage de l'instrument (SYSTem:PRESet).

[SENSe:]VOLTage:AC:SECOndary {"OFF"|"CALCulate:DATA"|"FREQuency"|"VOLTage[:DC]"}
 [SENSe:]VOLTage:AC:SECOndary?

Sélectionne la fonction de mesure secondaire pour les mesures en tension alternative.

Paramètre	Renvoi type
{"OFF" "CALCulate:DATA" "FREQuency" "VOLTage[:DC]"}, "OFF" par défaut	"CALC:DATA"
Configurez les mesures en tension alternative avec la plage de 100 V. Sélectionnez la fréquence comme mesure secondaire. Effectuer et récupérer des mesures : CONF:VOLT:AC 100 VOLT:AC:SEC "FREQ" READ?;DATA2? Réponse type : +8.54530000E+01;+1.00000000E+03	

- "CALCulate:DATA" - (Concerne uniquement les modèles 34465A et 34470A.) Valeur de mesure précédant toute opération mathématique (notamment l'opération NULL).
- "FREQuency" - Mesure de fréquence du signal d'entrée.
- « VOLTage[:DC] » - Mesure en tension continue du signal d'entrée. S'applique uniquement lors de l'utilisation de l'instrument depuis le panneau avant. Le paramètre est ignoré pour les mesures réalisées à partir d'une interface de commande à distance. Si vous nécessitez des mesures en tension alternative et tension continue à distance, programmez chaque fonction séparément. Voir **CONFigure[:VOLTage]:{AC|DC}**.
- Utilisez la commande **READ?** ou **INITiate** pour lancer la mesure.
- Ce paramètre est défini à sa valeur par défaut après une réinitialisation de la configuration d'usine (***RST**) ou un préreglage de l'instrument (**SYSTem:PRESet**).

[SENSe:]VOLTage[:DC]:APERture {<secondes>|MIN|MAX|DEF}
 [SENSe:]VOLTage[:DC]:APERture? [{MIN|MAX|DEF}]

Indique le temps d'intégration en secondes (appelé *temps d'ouverture*) pour toutes les mesures en tension continue.

REMARQUE

Utilisez cette commande pour un contrôle précis du temps d'intégration du multimètre numérique. Pour connaître les caractéristiques optimales de réjection de bruit de l'alimentation secteur (NPLC > 1), utilisez le NPLC (voir **[SENSe:]VOLTage[:DC]:NPLC**).

Paramètre	Renvoi type
(Sans l'option DIG) 200 µs à 1 s (résolution de 2 µs), valeur par défaut : 100 ms. (Avec l'option DIG) 20 µs à 1 s (résolution de 2 µs), valeur par défaut : 100 ms.	+1.00000000E-01
Activer le mode temps d'ouverture, définir le temps d'ouverture à 300 ms : VOLT:APER:ENAB ON VOLT:DC:APER 300E-03	

Référence de programmation SCPI

- Concerne uniquement les modèles 34465A et 34470A.
- Les commandes [SENSe:]<fonction>:NPLC et [SENSe:]<fonction>:APERture contrôlent le temps d'intégration de l'instrument. En cas d'utilisation de ces deux commandes (déconseillée), la commande envoyée pour la dernière fois remplace l'autre commande et définit le temps d'intégration. L'envoi de la commande [SENSe:]<fonction>:APERture entraîne le réglage de la commande [SENSe:]<fonction>:APERture:ENABLEd sur 1 (Activé) ; l'envoi de la commande [SENSe:]<fonction>:NPLC entraîne son réglage sur 0 (Désactivé).
- Ce paramètre est défini à sa valeur par défaut après une réinitialisation de la configuration d'usine (*RST) ou un préréglage de l'instrument (SYSTem:PRESet).

[SENSe:]VOLTage[:DC]:APERture:ENABLEd {ON|1|OFF|0}

[SENSe:]VOLTage[:DC]:APERture:ENABLEd?

Active la définition du temps d'intégration en secondes (appelé *temps d'ouverture*) pour les mesures en tension continue. Si le mode Temps d'ouverture est désactivé (par défaut), le temps d'intégration est défini en PLC (cycles de tension d'alimentation).

Paramètre	Renvoi type
{ON 1 OFF 0}. Valeur par défaut : OFF.	0 (OFF) ou 1 (ON)
Activer le mode temps d'ouverture, définir le temps d'ouverture à 300 ms :	
VOLT:APER:ENAB ON	
VOLT:DC:APER 300E-03	

- Concerne uniquement les modèles 34465A et 34470A.
- Les commandes CONFigure[:VOLTage][:DC], MEASure[:VOLTage][:DC]?, [SENSe:]VOLTage[:DC]:NPLC, et [SENSe:]VOLTage[:DC]:RESolution désactivent le mode temps d'ouverture et sélectionnent un temps d'intégration en nombre de cycles de tension d'alimentation.
- Ce paramètre est défini à sa valeur par défaut après une réinitialisation de la configuration d'usine (*RST) ou un préréglage de l'instrument (SYSTem:PRESet).

[SENSe:]VOLTage[:DC]:IMPedance:AUTO {ON|1|OFF|0}
 [SENSe:]VOLTage[:DC]:IMPedance:AUTO?

Désactive/active le mode d'impédance d'entrée automatique pour les mesures en tension continue et du rapport de tension continue.

Paramètre	Renvoi type
{ON 1 OFF 0}. Valeur par défaut : OFF.	0 (OFF) ou 1 (ON)
Effectuer toutes les mesures en tension continue avec une impédance d'entrée de 10 MΩ :	
VOLT:IMP:AUTO OFF	

- **OFF** : l'impédance d'entrée des mesures en tension continue est fixe à 10 MΩ pour toutes les plages afin de minimiser le captage du bruit.
- **ON** : l'impédance d'entrée des mesures en tension continue varie selon la plage. Elle est définie sur « HI-Z » (10 GΩ) pour les plages de 100 mV, 1 V et 10 V afin de réduire les erreurs de mesure dues aux effets de charge sur ces plages inférieures. Les plages de 100 V et 1 000 V conservent une impédance d'entrée de 10 MΩ.
- Les commandes **CONFigure** et **MEASure?** sélectionnent automatiquement « AUTO OFF ».
- Ce paramètre est défini à sa valeur par défaut après une réinitialisation de la configuration d'usine (***RST**) ou un préréglage de l'instrument (**SYSTem:PRESet**).

[SENSe:]VOLTage[:DC]:NPLC {<PLC>|MIN|MAX|DEF}
 [SENSe:]VOLTage[:DC]:NPLC? [{MIN|MAX|DEF}]

Définit le temps d'intégration en nombre de cycles de tension d'alimentation (PLC) pour les mesures en tension continue et du rapport de tension continue. Le temps d'intégration est la période durant laquelle le convertisseur analogique-numérique (CAN) de l'instrument échantillonne le signal d'entrée pour une mesure. Un temps d'intégration plus long permet d'améliorer la résolution de mesure, mais ralentit la vitesse de mesure.

Paramètre	Renvoi type
0,02 ; 0,2 ; 1 ; 10 ; 100. Valeur par défaut : 10 (34460A/61A) 0,02 ; 0,06 ; 0,2 ; 1 ; 10 ; 100. Valeur par défaut : 10 (34465A/70A sans option DIG) 0,001 ; 0,002 ; 0,006 ; 0,02 ; 0,06 ; 0,2 ; 1 ; 10 ; 100. Valeur par défaut : 10 (34465A/70A avec l'option DIG) Pour de plus amples informations, reportez-vous à la section Plage, résolution et NPLC .	+1.00000000E+01
Configurez les mesures en tension continue avec un temps d'intégration de 10 PLC. Puis, effectuez et lisez une mesure : CONF:VOLT:DC VOLT:DC:NPLC 10 READ? Réponse type : +6.27530000E-01	

- Seuls les temps d'intégration de 1, 10 et 100 PLC permettent une réjection (du bruit de fréquence réseau) en mode normal.
- Le réglage du temps d'intégration entraîne également celui de la résolution de mesure. Le [tableau de résolution](#) décrit le rapport entre le temps d'intégration et la résolution. Voir [\[SENSe:\]VOLTage\[:DC\]:RESolution](#).
- Ce paramètre est défini à sa valeur par défaut après une réinitialisation de la configuration d'usine (*RST) ou un pré-réglage de l'instrument (SYSTem:PRESet).

[SENSe:]VOLTage[:DC]:RATio:SECondary {"OFF"|"CALCulate:DATA"|"SENSe:DATA"}
[SENSe:]VOLTage[:DC]:RATio:SECondary?

Sélectionne la fonction de mesure secondaire pour les mesures du rapport de tension continue.

Paramètre	Renvoi type
{"OFF" "CALCulate:DATA" "SENSe:DATA"}, "OFF" par défaut	"CALC:DATA"
Configurez l'instrument pour des mesures du rapport de tension avec la plage de 100 V et une résolution de 1 mV. Sélectionnez « SENSe:DATA » comme mesure secondaire. Effectuer et récupérer des mesures : CONF:VOLT:DC:RAT 100,0.001 VOLT:RAT:SEC "SENS:DATA" READ?;DATA2? Réponse type : +1.05294698E+00;+2.10532098E+00,+1.99945584E+00	

- "CALCulate:DATA" - (Concerne uniquement les modèles 34465A et 34470A.) Valeur de mesure précédant toute opération mathématique (notamment l'opération NULL).
- « SENSe:DATA » - Mesures de la tension de signal continue et de la tension de référence continue.
- Ce paramètre est défini à sa valeur par défaut après une réinitialisation de la configuration d'usine (*RST) ou un pré réglage de l'instrument (SYSTem:PRESet).

[SENSe:]VOLTage[:DC]:RESolution {<résolution>|MIN|MAX|DEF}
[SENSe:]VOLTage[:DC]:RESolution? [{MIN|MAX|DEF}]

Sélectionne la résolution des mesures en tension continue et du rapport de tension continue. Saisissez la résolution dans les mêmes unités que pour la fonction de mesure sélectionnée, et non en nombre de chiffres.

Paramètre	Renvoi type
<résolution> : Voir Tableau de résolution ou Plage, résolution et NPLC . La valeur par défaut est équivalente à 10 PLC. Spécifiez la <résolution> dans les unités de mesure (V, A, Hz, Ω, etc.).	+3.00000000E-05
Configurez les mesures en tension continue avec une résolution de 3 µV. Puis, effectuez et lisez une mesure : CONF:VOLT:DC 1 VOLT:DC:RES 3E-6 READ?	

- Vous pouvez spécifier MIN (meilleure résolution) ou MAX (pire résolution) à la place de <résolution>.
- Pour obtenir une réjection (du bruit de fréquence réseau) en mode normal, utilisez une résolution qui correspond à un temps d'intégration représentant un nombre entier de cycles de tension d'alimentation.
- Ce paramètre est défini à sa valeur par défaut après une réinitialisation de la configuration d'usine (*RST) ou un pré réglage de l'instrument (SYSTem:PRESet).

[SENSe:]VOLTage[:DC]:SECondary {"OFF"|"CALCulate:DATA"|"VOLTage:AC"|"PTPeak"}
 [SENSe:]VOLTage[:DC]:SECondary?

Sélectionne la fonction de mesure secondaire pour les mesures en tension continue.

Paramètre	Renvoi type
{"OFF" "CALCulate:DATA" "VOLTage:AC" "PTPeak"}, "OFF" par défaut	"CALC:DATA"
Configurez les mesures en tension continue avec la plage de 10 V et la résolution de 1 mV. Sélectionnez la mesure secondaire Crête à crête. Effectuer et récupérer des mesures : CONF:VOLT:DC 10,0.001 VOLT:DC:SEC "PTP" READ?;DATA2? Réponse type : -3.44948894E-03;+9.91000000E+3,+9.91000000E+3	

- "CALCulate:DATA" - (Concerne uniquement les modèles 34465A et 34470A.) Valeur de mesure précédant toute opération mathématique (notamment l'opération NULL).
- "VOLTage:AC" - Mesure en tension alternative du signal d'entrée. S'applique uniquement lors de l'utilisation de l'instrument depuis le panneau avant. Le paramètre est ignoré pour les mesures réalisées à partir d'une interface de commande à distance. Si vous nécessitez des mesures en tensions alternative et tension continue à distance, programmez chaque fonction séparément. Voir [CONFigure\[:VOLTage\]:{AC|DC}](#).
- "PTPeak" - Valeurs crête à crête, maximale et minimale du signal d'entrée.
- Ce paramètre est défini à sa valeur par défaut après une réinitialisation de la configuration d'usine (*RST) ou un pré réglage de l'instrument (SYSTem:PRESet).

[SENSe:]VOLTage[:DC]:ZERO:AUTO {OFF|ON|ONCE}
 [SENSe:]VOLTage[:DC]:ZERO:AUTO?

Désactive/active le mode de réglage automatique du zéro pour les mesures en tension continue et du rapport de tension continue.

- **ON (valeur par défaut)** : le multimètre numérique mesure en interne le décalage après chaque mesure. Il soustrait ensuite cette mesure de la lecture précédente. Cette méthode évite que des tensions de décalage existantes sur le circuit d'entrée de l'instrument ne compromettent la précision de mesure.
- **OFF** : l'instrument utilise la dernière mesure de zéro effectuée et la soustrait de chaque mesure. Il recueille une nouvelle mesure du zéro chaque fois que vous modifiez la fonction, la plage ou le temps d'intégration.
- **ONCE** : l'instrument effectue une mesure du zéro et désactive le réglage automatique du zéro. La mesure du zéro effectuée est utilisée pour toutes les mesures suivantes jusqu'à la prochaine modification de la fonction, de la plage ou du temps d'intégration. Si le temps d'intégration spécifié est inférieur à 1 PLC, la mesure du zéro est effectuée à 1 PLC pour optimiser la réjection du bruit. Les mesures suivantes sont effectuées au temps d'intégration (< 1 PLC) rapide spécifié.

Paramètre	Renvoi type
{OFF ON ONCE}	0 (OFF) ou 1 (ON)
Configurez les mesures en tension continue et effectuez immédiatement un réglage automatique du zéro. Effectuez et lisez deux mesures : CONF:VOLT:DC 1 VOLT:DC:ZERO:AUTO ONCE SAMP:COUN 2 READ? Réponse type : +1.04530000E+01,+1.04570000E+01	

- Le mode de réglage automatique du zéro est défini indirectement lorsque vous configurez la résolution et le temps d'intégration à l'aide des commandes CONF:VOLTage:DC, CONF:VOLTage:DC:RATio, MEASure:VOLTage:DC? ou MEASure:VOLTage:DC:RATio?. Le réglage automatique du zéro est désactivé automatiquement lorsque vous choisissez un temps d'intégration inférieur à 1 PLC à l'aide de ces commandes.
- Ce paramètre est défini à sa valeur par défaut après une réinitialisation de la configuration d'usine (*RST) ou un préréglage de l'instrument (SYSTem:PRESet).

Sous-système STATus

Système d'état Agilent 34460A/34461A/34465A/34470A

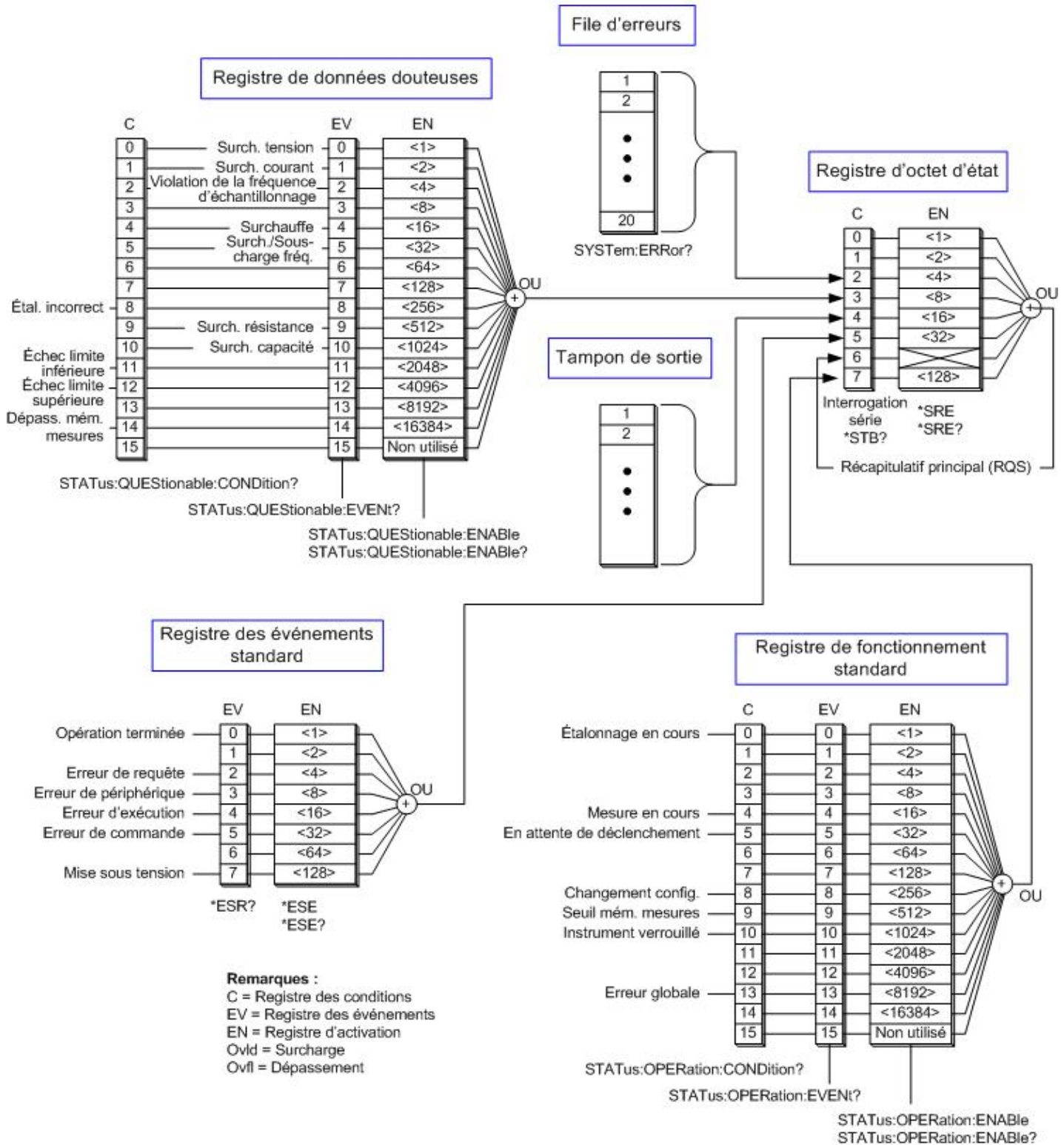

Le tableau suivant répertorie les définitions de bits du *registre de données douteuses* :

REMARQUE Les bits de surcharge sont activés une seule fois par commande **INITiate**. Si vous effacez un bit de surcharge, il ne sera réactivé qu'après l'envoi d'une nouvelle commande **INITiate**.

Numéro de bit	Nom du bit	Valeur décimale	Définition
0	Surtension	1	Uniquement signalé comme événement. Renvoie la valeur 0. Lisez le registre des événements.
1	Surintensité	2	Uniquement signalé comme événement. Renvoie la valeur 0. Lisez le registre des événements.
2	Violation de la fréquence d'échantillonnage	4	Une violation de fréquence d'échantillonnage impliquant la commande SAMPLE:TIMer s'est produite. La fréquence d'échantillonnage n'est peut-être pas valide. Concerne uniquement les modèles 34465A et 34470A.
3	Non utilisé	8	(Réservé à une utilisation ultérieure)
4	Surchauffe	16	Uniquement signalé comme événement. Renvoie la valeur 0. Lisez le registre des événements.
5	Surcharge/sous-charge de fréquence	32	Uniquement signalé comme événement. Renvoie la valeur 0. Lisez le registre des événements.
6	Non utilisé	64	(Réservé à une utilisation ultérieure)
7	Non utilisé	128	(Réservé à une utilisation ultérieure)
8	Étalonnage erroné	256	Au moins une constante d'étalonnage est erronée.
9	Surcharge de résistance	512	Uniquement signalé comme événement. Renvoie la valeur 0. Lisez le registre des événements.
10	Surcharge de capacité	1024	Uniquement signalé comme événement. Renvoie la valeur 0. Lisez le registre des événements.
11	Échec limite inférieure	2048	La dernière mesure a échoué au test de limite inférieure.
12	Échec limite supérieure	4096	La dernière mesure a échoué au test de limite supérieure.
13	Non utilisé	8192	(Réservé à une utilisation ultérieure)
14	Dépassement de capacité de la mémoire	16384	La mémoire de mesures est saturée. Une ou plusieurs mesures (les plus anciennes) ont été perdues.
15	Non utilisé	32768	(Réservé à une utilisation ultérieure)

Référence de programmation SCPI

Le tableau suivant répertorie les définitions de bits du *registre de fonctionnement standard* :

Numéro de bit	Nom du bit	Valeur décimale	Définition
0	Étalonnage en cours	1	L'instrument effectue un étalonnage.
1	Non utilisé	2	(Réservé à une utilisation ultérieure)
2	Non utilisé	4	(Réservé à une utilisation ultérieure)
3	Non utilisé	8	(Réservé à une utilisation ultérieure)
4	Mesure en cours	16	L'instrument est démarré, et effectue ou est sur le point d'effectuer une mesure.
5	En attente de déclenchement	32	L'instrument attend un déclenchement.
6	Non utilisé	64	(Réservé à une utilisation ultérieure)
7	Non utilisé	128	(Réservé à une utilisation ultérieure)
8	Changement de configuration	256	La configuration de l'instrument a été modifiée depuis la dernière commande INIT, READ? or MEASure?, à partir du panneau avant ou de SCPI.
9	Seuil de mémoire	512	Le nombre de mesures programmées (DATA:POINTS:EVENT:THReshold) a été stocké dans la mémoire de mesures.
10	Instrument verrouillé	1024	Défini si une interface de commande à distance (GPIB, USB ou LAN) est verrouillée (SYSTEM:LOCK:REQuest?). Effacé si l'interface de commande à distance libère le verrouillage (SYSTEM:LOCK:RELease).
11	Non utilisé	2048	(Réservé à une utilisation ultérieure)
12	Non utilisé	4096	(Réservé à une utilisation ultérieure)
13	Erreur globale	8192	Activé si la file d'erreurs d'une interface de commande à distance comporte une erreur ; sinon, il est effacé.
14	Non utilisé	16384	(Réservé à une utilisation ultérieure)
15	Non utilisé	32768	La valeur « 0 » est renvoyée.

Récapitulatif des commandes

STATus:OPERation:CONDition?

STATus:OPERation:ENABLE

STATus:OPERation[:EVENT]?

STATus:PRESet

STATus:QUEStionable:CONDition?

STATus:QUEStionable:ENABLE

STATus:QUEStionable[:EVENT]?

STATus:OPERation:CONDition?

Renvoie la somme des bits dans le registre de conditions pour le groupe de **registres de fonctionnement standard**. Ce registre est en lecture seule ; les bits ne sont pas effacés une fois lus.

Un registre de conditions surveille en permanence l'état de l'instrument. Les bits du registre de conditions sont mis à jour en temps réel ; ils ne sont ni verrouillés ni mis en mémoire tampon.

Paramètre	Renvoi type
(aucun)	+32
Lire le registre des conditions (bit 5 actif) :	
STAT:OPER:COND?	

- Les bits du registre de conditions reflètent l'état actuel. Si une condition n'est pas remplie, le bit correspondant est effacé dans le registre de conditions.

STATus:OPERation:ENABLE <valeur_activation>**STATus:OPERation:ENABLE?**

Active les bits du registre d'activation du groupe de **registres de fonctionnement standard**. Les bits sélectionnés sont ensuite reportés dans l'octet d'état. Un registre d'activation définit les bits du registre des événements qui seront reportés dans le groupe de registres d'octet d'état. Vous pouvez lire ou écrire dans un registre d'activation.

Paramètre	Renvoi type
Valeur décimale correspondant à la somme binaire pondérée des bits du registre.	+32
Activer le bit 5 (valeur décimale 32) dans le registre d'activation :	
STAT:OPER:ENAB 32	

- Utilisez le paramètre <activation> pour spécifier les bits qui seront reportés dans l'octet d'état. La valeur décimale spécifiée correspond à la somme binaire pondérée des bits que vous souhaitez activer dans le registre. Par exemple, pour activer le bit 5 (valeur décimale = 32) et le bit 9 (valeur décimale = 512), la valeur décimale correspondante est 544 (32 + 512).
- La commande **STATus:PRESet** efface tous les bits du registre d'activation.
- Le paramètre <activation> est non volatile. Il ne change pas après une réinitialisation de la configuration d'usine (***RST**), un préréglage de l'instrument (**SYSTem:PRESet**), un préréglage d'état (**STATus:PRESet**) ou un effacement d'état (***CLS**).
- La commande ***PSC** détermine si le registre d'activation est effacé à la mise sous tension.

STATus:OPERation[:EVENT]?

Renvoie la somme des bits dans le registre des événements pour le groupe de **registres de fonctionnement standard**. Un registre d'événements est un registre en lecture seule qui verrouille des événements du registre de conditions. Lorsqu'un bit d'événement est actif, les événements suivants correspondant à ce bit sont ignorés. Les bits sont effacés après la lecture du registre.

Paramètre	Renvoi type
(aucun)	+512
Lire le registre des événements (bit 9 actif) :	
STAT:OPER:EVEN?	

- Lorsqu'un bit est activé, il reste défini jusqu'à son effacement en lisant le registre des événements ou en envoyant la commande ***CLS** (effacement d'état).

STATus:PRESet

Efface les registres d'activation des **données douteuses** et de **fonctionnement standard**.

Paramètre	Renvoi type
(aucun)	(aucun)
Effacer les bits du registre d'activation :	
STAT:PRES	

STATus:QUEStionable:CONDition?

Renvoie la somme des bits dans le registre de conditions pour le groupe de **registres des données douteuses**. Ce registre est en lecture seule ; les bits ne sont pas effacés une fois lus.

Un registre de conditions surveille en permanence l'état de l'instrument. Les bits du registre de conditions sont mis à jour en temps réel ; ils ne sont ni verrouillés ni mis en mémoire tampon.

Paramètre	Renvoi type
(aucun)	+4096
Lire le registre de conditions (bit 12 actif) :	
STAT:QUES:COND?	

- Les bits du registre de conditions reflètent l'état actuel. Si une condition n'est pas remplie, le bit correspondant est effacé dans le registre de conditions.

STATus:QUESTIONable:ENABLE <valeur_activation>**STATus:QUESTIONable:ENABLE?**

Active les bits du registre d'activation du groupe de **registres des données douteuses**. Les bits sélectionnés sont ensuite reportés dans l'octet d'état. Un registre d'activation définit les bits du registre des événements qui seront reportés dans le groupe de registres d'octet d'état. Vous pouvez lire ou écrire dans un registre d'activation.

Paramètre	Renvoi type
Valeur décimale correspondant à la somme binaire pondérée des bits du registre.	+512
Activer le bit 9 (valeur décimale 512) dans le registre d'activation.	

- Utilisez le paramètre <activation> pour spécifier les bits qui seront reportés dans l'octet d'état. La valeur décimale spécifiée correspond à la somme binaire pondérée des bits que vous souhaitez activer dans le registre. Par exemple, pour activer le bit 0 (valeur décimale = 1), le bit 1 (valeur décimale = 2) et le bit 12 (valeur décimale = 4 096), la valeur décimale correspondante est 4 099 (1 + 2 + 4 096).
- La commande **STATus:PRESet** efface tous les bits du registre d'activation.
- Le paramètre <activation> est non volatile. Il ne change pas après une réinitialisation de la configuration d'usine (***RST**), un préréglage de l'instrument (**SYSTEM:PRESet**), un préréglage d'état (**STATus:PRESet**) ou un effacement d'état (***CLS**).
- La commande ***PSC** détermine si le registre d'activation est effacé à la mise sous tension.

STATus:QUESTIONable[:EVENT]?

Renvoie le registre des événements du groupe de **registres des données douteuses**. Un registre d'événements est un registre en lecture seule qui verrouille des événements du registre de conditions. Lorsqu'un bit d'événement est actif, les événements suivants correspondant à ce bit sont ignorés. Les bits sont effacés après la lecture du registre.

Paramètre	Renvoi type
(aucun)	+1024
Lire le registre des événements (bit 10 actif) :	
STAT:QUES?	

- Lorsqu'un bit est activé, il reste défini jusqu'à son effacement en lisant le registre des événements ou en envoyant la commande ***CLS** (effacement d'état).

Sous-système SYSTem - Commandes de base

Le sous-système SYSTem inclut des commandes générales (répertoriées ci-dessous), des **commandes de gestion des licences** et des **commandes de configuration de l'interface de commande à distance**.

Récapitulatif des commandes

SYSTem:ACALibration:DATE?

SYSTem:ACALibration:TEMPerature?

SYSTem:ACALibration:TIME?

SYSTem:BEEPer[:IMMEDIATE]

SYSTem:BEEPer:STATe

SYSTem:CLICk:STATe

SYSTem:DATE

SYSTem:ERRor[:NEXT]?

SYSTem:HELP?

SYSTem:IDENtify

SYSTem:LABel

SYSTem:LFRequency?

SYSTem:LOCal

SYSTem:PRESet

SYSTem:SECurity:COUNT?

SYSTem:SECurity:IMMEDIATE

SYSTem:TEMPerature?

SYSTem:TIME

SYSTem:UPTime?

SYSTem:VERSion?

SYSTem:WMESsage

SYSTem:ACALibration:DATE?

Renvoie la date du dernier étalonnage automatique au format *aaaa,mm,jj*.

Paramètre	Renvoi type
(aucun)	2014,4,26
Renvoyer la date d'étalonnage automatique :	
SYST:ACAL:DATE?	

- (34465A/70A uniquement)
- Vous pouvez exécuter cette requête, que la sécurité de l'instrument soit ou non verrouillée.
- La date est basée sur l'horloge en temps réel de l'instrument. Règle la date de l'horloge en temps réel de l'instrument avec **SYSTem:DATE**.
- L'horloge en temps réel ne se règle pas d'elle-même pour les modifications du fuseau horaire ou l'heure d'été/hiver. Assurez-vous de régler la date et l'heure à la réception de l'instrument.
- Ce paramètre est non volatile ; il n'est pas altéré par une remise sous tension ou l'exécution de la commande ***RST** ou **SYSTem:PRESet**.
- Utilisez la commande ***CAL?** pour effectuer un étalonnage automatique.

Voir également

SYSTem:DATE

SYSTem:ACALibration:TEMPerature?

Renvoie la température du dernier étalonnage automatique en °C.

Paramètre	Renvoi type
(aucun)	+2.42850208E+001
Renvoyer la température d'étalonnage automatique :	
SYST:ACAL:TEMP?	

- (34465A/70A uniquement)
- Vous pouvez exécuter cette requête, que la sécurité de l'instrument soit ou non verrouillée.
- Ce paramètre est non volatile ; il n'est pas altéré par une remise sous tension ou l'exécution de la commande ***RST** ou **SYSTem:PRESet**.
- Utilisez la commande ***CAL?** pour effectuer un étalonnage automatique.

SYSTem:ACALibration:TIME?

Renvoie l'heure du dernier étalonnage automatique au format *hh,mm,ss.sss*.

Paramètre	Renvoi type
(aucun)	20,15,30,000
Renvoyer l'heure d'étalonnage :	
SYST:ACAL:TIME?	

- (34465A/70A uniquement)
- La date est basée sur l'horloge en temps réel de l'instrument. Règle la date de l'horloge en temps réel de l'instrument avec la commande SYSTem:DATE.
- L'horloge en temps réel ne se règle pas d'elle-même pour les modifications du fuseau horaire ou l'heure d'été/hiver. Assurez-vous de régler la date et l'heure à la réception de l'instrument.
- Ce paramètre est défini à sa valeur par défaut après une réinitialisation de la configuration d'usine (*RST) ou un pré-réglage de l'instrument (SYSTem:PRESet).
- Utilisez la commande *CAL? pour effectuer un étalonnage automatique.

Voir également

SYSTem:TIME

SYSTem:BEEPer[:IMMEDIATE]

Émet un signal sonore unique.

Paramètre	Renvoi type
(aucun)	(aucun)
Émettre un signal sonore unique :	
SYST:BEEP	

- Les signaux sonores programmés peuvent être utiles pour le développement et la mise au point de programmes.
- Vous pouvez émettre un signal sonore à l'aide de cette commande, quel que soit l'état actuel de l'avertisseur sonore (SYSTem:BEEPer:STATE).

SYSTem:BEEPer:STATe {ON|1|OFF|0}**SYSTem:BEEPer:STATe?**

Désactive ou active le signal sonore qui retentit lors des mesures de continuité, de diodes ou en Probe Hold (Maintien de la sonde), ou lorsqu'une erreur est générée à partir du panneau avant ou de l'interface de commande à distance.

Paramètre	Renvoi type
{ON 1 OFF 0}. Valeur par défaut : ON.	0 (OFF) ou 1 (ON)
Désactiver l'état de l'avertisseur sonore :	
SYST:BEEP:STAT OFF	

- N'affecte pas les clics sur une touche du panneau avant.
- Un signal sonore est toujours émis (même si l'avertisseur sonore est désactivé (OFF)) lorsque la commande **SYSTem:BEEPer** est envoyée.
- Ce paramètre est non volatile ; il n'est pas altéré par une remise sous tension, une réinitialisation de la configuration d'usine (***RST**) ou un pré réglage de l'instrument (**SYSTem:PRESet**).

SYSTem:CLICk:STATe {ON|1|OFF|0}**SYSTem:CLICk:STATe?**

Désactive ou active le clic entendu lorsqu'une touche ou une touche de fonction du panneau avant est enfoncée.

Paramètre	Renvoi type
{ON 1 OFF 0}. Valeur par défaut : ON.	0 (OFF) ou 1 (ON)
Désactiver les clics du clavier :	
SYST:CLIC:STAT OFF	

- N'affecte pas l'avertisseur sonore associé aux tests de diodes et de continuité, aux erreurs, etc.
- Ce paramètre est non volatile ; il n'est pas altéré par une remise sous tension, une réinitialisation de la configuration d'usine (***RST**) ou un pré réglage de l'instrument (**SYSTem:PRESet**).

SYSTem:DATE <année>, <mois>, <jour>

SYSTem:DATE?

Règle la date de l'horloge en temps réel de l'instrument. Utilisez la commande **SYSTem:TIME** pour régler l'heure.

Paramètre	Renvoi type
<année> 2000 à 2099 <mois> 1 à 12 <jour> 1 à 31	+2011,+07,+26
Régler la date du système au 26 juillet 2011 :	
SYST:DATE 2011, 7,26	

- L'horloge en temps réel est utilisée pour les horodatages de fichiers du système de mémoire de masse (MMEMory).
- L'horloge en temps réel est sauvegardée sur batterie et conserve la date et l'heure lorsque l'instrument est éteint.
- La date et l'heure ne sont pas affectées par la commande ***RST** ou **SYSTem:PRESet**.
- L'horloge en temps réel ne se règle pas d'elle-même pour les modifications du fuseau horaire ou l'heure d'été/hiver. Assurez-vous de régler la date et l'heure à la réception de l'instrument.

SYSTem:ERRor[:NEXT]?

Lit et efface une erreur dans la file d'erreurs. Pour une liste complète des messages d'erreur SCPI, reportez-vous à la section **Messages d'erreur SCPI**.

Paramètre	Renvoi type
(aucun)	-113, "Undefined header" (En-tête indéfini)
Lire et effacer la première erreur dans la file d'erreurs :	
SYST:ERR?	

- La file d'erreurs de l'instrument peut enregistrer jusqu'à 20 erreurs. Chaque session d'E/S de l'interface de commande à distance (GPIB, USB, VXI-11, Telnet/Sockets) comporte une file d'erreurs propre à l'interface. Les erreurs sont affichées dans la file d'erreurs de la session d'E/S qui a généré l'erreur. Par exemple, si une erreur a été générée par une commande envoyée via GPIB, envoyez la commande **SYSTem:ERRor?** depuis l'interface GPIB pour lire la file des erreurs. Les erreurs générées par le matériel de l'instrument sont diffusées sur toutes les sessions d'E/S.
- Erreur de récupération « premier entré/premier sorti » (FIFO) ; ces erreurs sont effacées à la lecture. L'instrument émet un signal sonore chaque fois qu'une erreur est générée (sauf si l'avertisseur sonore est désactivé par la commande **SYSTem:BEEPer:STATe OFF**).
- Si plus de 20 erreurs se produisent, la dernière erreur enregistrée dans la file d'attente est remplacée par -350, "Queue overflow" (dépassement de la capacité de la file d'attente). Aucune erreur supplémentaire n'est enregistrée tant que vous ne supprimez pas des erreurs de la file. Si aucune erreur ne s'est produite depuis la dernière consultation de la file d'erreurs, l'instrument indique +0, "No error" (Aucune erreur).
- Les erreurs présentent le format suivant (la chaîne de caractères d'erreur peut contenir jusqu'à 255 caractères) :

<code d'erreur>, <chaîne de caractères d'erreur>

Où :

<code d'erreur> = entier positif ou négatif

<chaîne de caractères d'erreur> = chaîne de caractères ASCII entre guillemets contenant jusqu'à 255 caractères

Voir également

***SRE**

SYSTem:HELP?

Renvoie une liste complète des commandes SCPI de l'instrument.

Paramètre	Renvoi type
(aucun)	(voir ci-dessous)
Renvoyer la liste des commandes SCPI :	
SYST:HELP?	

- Cette requête renvoie des données en bloc de longueur définie, qui permettent de transmettre n'importe quel type de données sous forme d'un ensemble de données binaires sur 8 bits. La première ligne se compose d'un symbole dièse (#), suivi d'un chiffre représentant le nombre de chiffres dans l'entier décimal à suivre. Ce chiffre est suivi d'un entier décimal qui indique le nombre d'octets de données à suivre, puis du premier caractère Nouvelle ligne (par exemple, l'indication « #47947 » sur la première ligne signifie qu'il existe 7 947 octets de données à suivre). Le reste du bloc comporte une seule commande par ligne, chacune terminée par un caractère Nouvelle ligne (caractère ASCII 10).

Le début d'une liste renvoyée est illustré ci-dessous. Notez que le contenu réel peut varier, selon la version du microprogramme :

```
#48085
:ABORt/nquery/
:CALibration:ADC?/qonly/
:CALibration:ALL?/qonly/
:CALibration:COUNT?/qonly/
:CALibration:DATA
```

Dans cette liste,

- /nquery/ indique une commande sans requête.
- /qonly/ indique une requête sans forme de commande.
- Toutes les autres commandes comprennent une commande et une requête.
- La syntaxe de chaque commande est décrite dans l'[Aide-mémoire des commandes](#).
- La liste peut inclure des commandes ou des requêtes qui ne sont pas abordées dans ce document. Ces dernières sont des commandes obsolètes qui ont été incluses à des fins de compatibilité avec des instruments plus anciens.

SYSTem:IDENTify {DEFault|AT34460A|AT34461A|AT34410A|AT34411A|HP34401A}
SYSTem:IDENTify?

Sélectionne le fabricant et le numéro de modèle renvoyé par ***IDN?**. Les informations sur le numéro de série et la version ne sont pas affectées. Aussi, cette commande n'altère pas le fonctionnement de l'instrument. Utilisez ce paramètre pour éviter toute modification du code du système de test existant lors de la vérification du fabricant ou du numéro de modèle.

Paramètre	Renvoi type
{DEFault AT34460A AT34461A AT34410A AT34411A HP34401A} (voir les points d'énumération ci-dessous)	DEF (voir les points d'énumération ci-dessous), HP34401A, AT34410A ou AT34411A
Sélectionner une réponse *IDN? compatible avec le modèle 34401A :	
SYST:IDEN HP34401A *IDN?	
Réponse type : HEWLETT-PACKARD,34401A,...	

- Les paramètres autorisés pour chaque modèle de multimètre numérique sont décrits ci-dessous :
 - 34460A - paramètres valides : DEFault, AT34460A, HP34401A
 - 34461A - paramètres valides : DEFault, AT34461A, HP34401A
 - 34465A - paramètres valides : DEFault, AT34410A, AT34411A
 - 34470A - paramètres valides : DEFault, AT34410A, AT34411A
- DEFault renvoie « Keysight Technologies », suivi du numéro de modèle réel de l'instrument :
 - « Keysight Technologies,34460A, ... »
 - « Keysight Technologies,34461A, ... »
 - « Keysight Technologies,34465A, ... »
 - « Keysight Technologies,34470A, ... »
- Si vous possédez un ancien modèle Agilent 34460A ou 34461A et que vous effectuez une mise à niveau vers le nouveau microprogramme (Keysight), votre instrument continue de répondre avec le nom de fabricant « Agilent » et non « Keysight » tant que vous n'avez pas défini l'ID SCPI du panneau avant sur 34460A ou 34461A, envoyé la commande **SYST:IDEN DEF** ou réinitialisé les préférences utilisateur. Une fois cette opération terminée, l'instrument répond avec le nom de fabricant « Keysight ».
- Ce paramètre est non volatile ; il n'est pas altéré par une remise sous tension, une réinitialisation de la configuration d'usine (***RST**) ou un préreglage de l'instrument (**SYSTem:PRESet**).

Référence de programmation SCPI

- **Important** : Pour mettre à jour le microprogramme de l'instrument à *partir de l'interface de commande à distance*, le numéro de modèle de la réponse ***IDN?** doit correspondre à celui de l'instrument réel. Si vous avez remplacé la réponse ***IDN?** de l'instrument par celle d'un autre instrument, lors de la tentative de mise à jour du microprogramme à partir de l'interface de commande à distance, l'erreur suivante s'affiche : *The instrument is not supported by this firmware file (L'instrument n'est pas pris en charge par ce fichier de microprogramme)*. Pour mettre le microprogramme à jour, suivez la procédure indiquée sur le panneau avant ou, dans l'interface de commande à distance, utilisez la commande **SYSTem:IDENtify** pour définir la réponse ***IDN?** afin qu'elle corresponde au numéro de modèle réel, mettez le microprogramme à jour, puis réutilisez la commande **SYSTem:IDENtify** pour définir la réponse ***IDN?** sur l'autre numéro de modèle.

SYSTem:LABel "<chaîne>"

SYSTem:LABel?

Place un message en gros caractères dans la partie inférieure de l'écran du panneau avant de l'instrument.

Paramètre	Renvoi type
Chaîne entre guillemets contenant jusqu'à 40 caractères. Vous pouvez utiliser des lettres (A-Z), des chiffres (0-9) et des caractères spéciaux comme @, %, *, etc. Valeur par défaut : ""	"Battery DCI" (Courant continu batterie)
Définir le message qui doit être affiché à l'écran : SYST:LAB "Battery DCI" Pour désactiver le message, envoyez la commande suivante pour remplacer le libellé par une chaîne vide. La zone du libellé est également supprimée de l'écran : SYST:LAB ""	

- Si vous entrez une chaîne contenant plus de 40 caractères, l'instrument tronque cette dernière au-delà des 40 premiers caractères.
- La taille de police change selon la longueur du message et les autres informations affichées à l'écran.
- La valeur de ce paramètre n'est pas affectée par la commande ***RST** ou **SYSTem:PRESet**.

SYSTem:LFRequency?

Queries the line frequency.

Paramètre	Renvoi type
(aucun)	+50
Query the line frequency: SYST:LFR?	

- At power on, the DMM sets the line frequency to the actual line frequency of either 50 Hz or 60 Hz (400 Hz is detected as 50 Hz).
- The line frequency value is not affected by ***RST** or **SYSTem:PRESet**.

SYSTem:LOCal

Sets the instrument state to local, clears the Remote display annunciator, and enables front-panel operation.

Paramètre	Renvoi type
(aucun)	(aucun)
Set the instrument state to local: SYST:LOC	

SYSTem:PRESet

Cette commande est pratiquement identique à ***RST**. La différence est que la commande ***RST** réinitialise l'instrument pour une utilisation de SCPI alors que la commande **SYSTem:PRESet** réinitialise l'instrument pour une utilisation du panneau avant. Par conséquent, la commande ***RST** désactive l'histogramme et les statistiques, alors que la commande **SYSTem:PRESet** les active.

SYSTem:SECurity:COUNT?

Renvoie le nombre de verrouillages de sécurité de l'instrument.

Paramètre	Renvoi type
(aucun)	+22
Renvoyer le nombre de verrouillages de sécurité de l'instrument : SYSTem:SECurity:COUNT?	

- Le nombre de verrouillages de sécurité augmente d'une unité chaque fois que vous effectuez une action (à l'exception d'un étalonnage) nécessitant un déverrouillage de l'instrument. Ces actions peuvent être l'activation ou la désactivation d'interfaces, le nettoyage de la mémoire conformément à la norme NISPOM (**SYSTem:SECurity:IMMEDIATE**), la mise à jour du microprogramme, la modification du code de sécurité ou le remplacement de la sécurité d'étalonnage.
- Le fait d'activer ou de désactiver la sécurité de l'instrument n'entraîne pas l'incrémentation du compteur.
- Assurez-vous de lire le nombre de verrouillages de sécurité à la réception de votre instrument.

Voir également

CALibration:COUNT?

SYSTem:SECurity:IMMEDIATE

(Requiert l'option SEC.) Nettoie toute la mémoire de l'instrument accessible à l'utilisateur, à l'exception des constantes d'étalonnage et redémarre l'instrument. Cette commande est conforme aux exigences du Chapitre 8 du National Instrument Security Program Operating Manual (NISPOM).

Requiert la fonctionnalité de sécurité en option. Pour de plus amples informations, reportez-vous à la section [Modèles et options](#).

MISE EN GARDE

La touche de fonction **NISPOM Sanitize** et la commande SYSTem:SECurity:IMMEDIATE ont la même fonction. Elles sont destinées à des clients (ex. sous-traitants militaires) qui doivent satisfaire les exigences NISPOM.

Cette fonction détruit toutes les informations d'état définies par l'utilisateur, les données de mesure et des paramètres d'E/S définis par l'utilisateur, tels que l'adresse IP. Son utilisation est déconseillée dans les applications de routine en raison des risques de perte involontaire de données.

Paramètre	Renvoi type
(aucun)	(aucun)
Nettoyer toute la mémoire de l'instrument accessible à l'utilisateur : SYST:SEC:IMM	

- Généralement utilisée avant de retirer un instrument d'une zone sécurisée.
- Initialise tous les réglages par défaut effectués en usine (***RST**). Elle supprime également toutes les informations de préférence et de configuration définies par l'utilisateur (voir [Sous-système MMEMoRY - Fichiers STATE et PREFERENCE](#)).
- Augmente le **nombre de verrouillages de sécurité**.

SYSTem:TEMPerature?

Renvoie la température interne de l'instrument en °C.

Paramètre	Renvoi type
(aucun)	+2.85000000E+01
Renvoyer la température interne de l'instrument : SYST:TEMP?	

- La valeur renvoyée n'est pas affectée par la commande [UNIT:TEMPerature](#).

SYSTem:TIME <heure>, <minute>, <seconde>

SYSTem:TIME?

Règle l'heure de l'horloge en temps réel de l'instrument. Utilisez la commande SYSTem:DATE pour régler la date.

Paramètre	Renvoi type
<heure> 0 à 23 <minute> 0 à 59 <seconde> 0 à 60	20,15,30,000
Régler l'heure de l'instrument à 20:15:30 (8:15:30 PM) :	
SYST:TIME 20,15,30	

- L'horloge en temps réel est utilisée pour les horodatages de fichiers du système de mémoire de masse (MMEMory).
- L'horloge en temps réel est sauvegardée sur batterie et conserve la date et l'heure lorsque l'instrument est éteint.
- La date et l'heure ne sont pas affectées par la commande ***RST** ou **SYSTem:PRESet**.
- L'horloge en temps réel ne se règle pas d'elle-même pour les modifications du fuseau horaire ou l'heure d'été/hiver. Assurez-vous de régler la date et l'heure à la réception de l'instrument.

SYSTem:UPTime?

Renvoie la durée pendant laquelle l'instrument a fonctionné depuis la dernière mise sous tension.

Paramètre	Renvoi type
(aucun)	+8,+2,+13,+50
Renvoyer la durée pendant laquelle l'instrument a fonctionné :	
SYST:UPT?	

- Généralement utilisée pour vérifier que l'instrument est suffisamment réchauffé avant l'étalonnage.
- Les nombres renvoyés indiquent les jours, les heures, les minutes et les secondes, respectivement.

SYSTem:VERSion?

Renvoie la version du langage SCPI (Standard Commands for Programmable Instruments) de l'instrument. Il n'existe aucune commande équivalente sur le panneau avant. Pour de plus amples informations, reportez-vous à la section **Présentation du Présentation du langage SCPI**.

Paramètre	Renvoi type
(aucun)	1994.0
Renvoyer la version SCPI :	
SYST:VERS?	

SYSTem:WMESsage "<chaîne>"

SYSTem:WMESsage?

Affiche un message à la mise sous tension.

Paramètre	Renvoi type
Chaîne entre guillemets contenant jusqu'à 40 caractères. Vous pouvez utiliser des lettres (A-Z), des chiffres (0-9) et des caractères spéciaux comme @, %, *, etc. Valeur par défaut : ""	"RETURN TO JOE AT POST D6"
Afficher un message à la mise sous tension : SYST:WMES "RETURN TO JOE AT POST D6"	

- L'indication d'une chaîne vide ("") entraîne la désactivation du message à la mise sous tension.
- Ce paramètre est non volatile ; il n'est pas altéré par une remise sous tension, une réinitialisation de la configuration d'usine (*RST) ou un préréglage de l'instrument (SYSTem:PRESet).
- Ce paramètre est défini sur la valeur par défaut lorsque l'instrument est expédié de l'usine et après l'exécution de la commande SYSTem:SECurity:IMMediate.

Sous-système SYSTem - Configuration des E/S

Le sous-système SYSTem inclut des **commandes de configuration générales de l'instrument**, des **commandes de verrouillage des E/S**, des **commandes de gestion des licences** et des commandes de configuration de l'interface de commande à distance (répertoriées ci-dessous).

Récapitulatif des commandes

SYSTem:COMMunicate:ENABle

SYSTem:COMMunicate:GPIB:ADDResS

SYSTem:COMMunicate:LAN:CONTRol?

SYSTem:COMMunicate:LAN:DHCP

SYSTem:COMMunicate:LAN:DNS[1|2]

SYSTem:COMMunicate:LAN:DOMain?

SYSTem:COMMunicate:LAN:GATeway

SYSTem:COMMunicate:LAN:HOSTname

SYSTem:COMMunicate:LAN:IPADdress

SYSTem:COMMunicate:LAN:MAC?

SYSTem:COMMunicate:LAN:SMASk

SYSTem:COMMunicate:LAN:TELNet:PROMpt

SYSTem:COMMunicate:LAN:TELNet:WMESsage

SYSTem:COMMunicate:LAN:UPDate

SYSTem:COMMunicate:LAN:WINS[1|2]

SYSTem:USB:HOST:ENABle

SYSTem:COMMunicate:ENABle {ON|1|OFF|0}, <interface>

SYSTem:COMMunicate:ENABle? <interface>

Active/désactive l'interface de commande à distance du réseau local, GPIB ou USB. Active ou désactive également les services distants disponibles (ex. Sockets, HiSLIP, Telnet, VXI11) et l'interface Web intégrée.

REMARQUE

L'interface GPIB est une fonctionnalité en option. Pour de plus amples informations, reportez-vous à la section **Modèles et options**.

Paramètre	Renvoi type
{ON 1 OFF 0}. Valeur par défaut : ON. pour toutes les interfaces	0 (OFF) ou 1 (ON)
<interface> : {GPIB HISLip USB LAN SOCKets TELNet VXI11 WEB USBMtp USBHost}	
Désactiver l'interface USB :	
SYST:COMM:ENAB OFF,USB	

- Une fois les modifications apportées, vous devez éteindre puis remettre l'instrument sous tension afin que les modifications soient prises en compte.
- L'activation de l'interface USBMtp vous permet de transférer des fichiers à l'aide du protocole de transfert de supports (MTP), de l'instrument vers un ordinateur via le port USB du panneau arrière. Pour de plus amples informations sur MTP, reportez-vous à la section **Menu Utility (Utilitaire) - I/O Configuration (Configuration des E/S)**.
- Le paramètre USBHost désigne le port USB du panneau avant de l'instrument.
- Si vous désactivez l'interface du réseau local, aucun des services réseau associés ne démarre lorsque vous mettez l'instrument sous tension.
- **SYSTem:SECurity:IMMEDIATE** active toutes les interfaces, à l'exception d'USBMtp.
- Pour HiSLIP, LAN, SOCKets, TELNet, VXI11 ou WEB sur le modèle 34460A, vous devez disposer de l'option 34460A-LAN ou de l'option 3446LANU.
- Les paramètres d'activation de l'interface sont stockés en mémoire volatile. Ils ne changent pas lorsque l'instrument est remis sous tension, après réinitialisation de la configuration d'usine (***RST**) ou après un pré réglage de l'instrument (**SYSTem:PRESet**).

SYSTem:COMMunicate:GPIB:ADDRess <adresse>
SYSTem:COMMunicate:GPIB:ADDRess?

Affecte l'adresse GPIB (IEEE-488) de l'instrument, qui s'affiche à la mise sous tension. Chaque périphérique connecté à l'interface GPIB doit avoir une adresse unique.

REMARQUE

L'interface GPIB est une fonctionnalité en option. Pour de plus amples informations, reportez-vous à la section **Modèles et options**.

Paramètre	Renvoi type
0 à 30, 22 par défaut	+15
Définir l'adresse GPIB sur 15 :	
SYST:COMM:GPIB:ADDR 15	

- La carte d'interface GPIB de votre ordinateur possède sa propre adresse. Évitez d'utiliser cette adresse pour un instrument sur le bus GPIB.
- L'instrument doit être éteint puis rallumé pour que cette commande prenne effet.
- GPIB est activé ou désactivé par la commande **SYSTem:COMMunicate:ENABle**.
- L'interface GPIB est une fonctionnalité en option. Pour de plus amples informations, reportez-vous à la section **Modèles et options**.
- Ce paramètre est non volatile ; il n'est pas altéré par une remise sous tension, une réinitialisation de la configuration d'usine (***RST**) ou un préréglage de l'instrument (**SYSTem:PRESet**).
- Ce paramètre est défini sur la valeur par défaut lorsque l'instrument est expédié de l'usine et après l'exécution de la commande **SYSTem:SECurity:IMMediate**.

SYSTem:COMMunicate:LAN:CONTRol?

Lit le numéro initial de port de connexion de contrôle pour les communications par sockets. Cette connexion est utilisée pour envoyer et recevoir des commandes et des requêtes.

Paramètre	Renvoi type
(aucun)	5 000 (0 si l'interface ne prend pas en charge les sockets)
Renvoyer le numéro du port de connexion de contrôle :	
SYST:COMM:LAN:CONT?	

- Utilise la connexion par socket des commandes pour envoyer la commande Device Clear à l'instrument ou détecter les événements de demande de service (Service Request - SRQ) en attente.
- Sur le modèle 34460A, l'option 34460A-LAN ou l'option 3446LANU est requise.

SYSTem:COMMunicate:LAN:DHCP {ON|1|OFF|0}

SYSTem:COMMunicate:LAN:DHCP?

Active ou désactive l'utilisation du protocole DHCP par l'instrument. DHCP est l'abréviation de Dynamic Host Configuration Protocol ; il s'agit d'un protocole d'attribution d'adresses IP dynamiques IP à des périphériques en réseau. Avec l'adressage dynamique, un périphérique peut avoir une adresse IP différente chaque fois qu'il se connecte au réseau.

ON : l'instrument tente d'obtenir une adresse IP d'un serveur DHCP. Si l'instrument trouve un serveur DHCP, celui-ci lui attribue une **adresse IP** dynamique, un **masque de sous-réseau** et une **passerelle par défaut**.

OFF ou DHCP unavailable : l'instrument utilise l'adresse IP statique, le masque de sous-réseau et la passerelle par défaut à la mise sous tension.

REMARQUE

Si vous modifiez ce paramètre, vous devez envoyer la commande **SYSTem:COMMunicate:LAN:UPDate** pour activer le nouveau paramètre.

Paramètre	Renvoi type
{ON 1 OFF 0}. Valeur par défaut : ON.	0 (OFF) ou 1 (ON)
Désactiver DHCP :	
SYST:COMM:LAN:DHCP OFF	
SYST:COMM:LAN:UPDate	

- La plupart des réseaux locaux d'entreprise comportent un serveur DHCP.
- La commande **SYSTem:SECurity:IMMEDIATE** définit ce paramètre sur sa valeur par défaut.
- Sur le modèle 34460A, l'option 34460A-LAN ou l'option 3446LANU est requise.
- Si une adresse réseau DHCP n'est pas attribuée par un serveur DHCP, une adresse Auto-IP est fournie après environ 2 minutes. Une adresse Auto-IP se présente sous la forme 169.254.nnn.nnn.
- Ce paramètre est non volatile ; il n'est pas altéré par une remise sous tension, une réinitialisation de la configuration d'usine (***RST**) ou un préreglage de l'instrument (**SYSTem:PRESet**).

SYSTem:COMMunicate:LAN:DNS[{1|2}**] "<adresse>"**
SYSTem:COMMunicate:LAN:DNS[{1|2}**]? [**{CURRENT|STATIC}**]**

Attribue les adresses IP statiques des serveurs DNS (Domain Name System). Une adresse de serveur principale et secondaire peut être affectée. Si le protocole DHCP est disponible et activé, il attribue automatiquement ces adresses de serveur. Ces adresses attribuées automatiquement sont prioritaires sur les adresses statiques affectées avec cette commande. Pour de plus amples informations, contactez votre administrateur réseau.

REMARQUE

Si vous modifiez ce paramètre, vous devez envoyer la commande **SYSTem:COMMunicate:LAN:UPDate** pour activer le nouveau paramètre.

Paramètre	Renvoi type
Commande : " nnn.nnn.nnn.nnn ". Valeur par défaut : "0.0.0.0".	"198.105.232.4"
Requête : {CURRENT STATIC}. Valeur par défaut : CURRENT.	
Définir une adresse DNS principale statique :	
SYST:COMM:LAN:DNS "198.105.232.4"	
SYST:COMM:LAN:UPD	

- **CURRENT**: renvoie l'adresse actuellement utilisée par l'instrument.
- **STATIC**: renvoie l'adresse statique de la mémoire non volatile. Cette adresse IP est utilisée si le protocole DHCP est désactivé ou indisponible.
- La commande **SYSTem:SECurity:IMMEDIATE** définit ce paramètre sur sa valeur par défaut.
- Sur le modèle 34460A, l'option 34460A-LAN ou l'option 3446LANU est requise.
- Les adresses de serveur DNS attribuées sont utilisées si DHCP est désactivé ou indisponible. Sinon, les adresses de serveur DNS sont automatiquement attribuées par DHCP.
- Les adresses de serveur DNS sont stockées en mémoire volatile. Ils ne changent pas lorsque l'instrument est remis sous tension, après réinitialisation de la configuration d'usine (***RST**) ou après un préreglage de l'instrument (**SYSTem:PRESet**).

SYSTem:COMMunicate:LAN:DOMain?

Renvoie le nom de domaine attribué à l'instrument.

Paramètre	Renvoi type
(aucun)	"example.com" (exemple.com)
Renvoyer le nom de domaine actuellement utilisé par l'instrument :	
SYST:COMM:LAN:DOM?	

- Si le système DNS (Domain Name System) dynamique est disponible sur votre réseau et que votre instrument utilise le protocole **DHCP**, le nom de domaine est attribué par le service DNS dynamique à la mise sous tension.
- Une chaîne vide ("") indique qu'aucun nom de domaine n'est attribué.
- Sur le modèle 34460A, l'option 34460A-LAN ou l'option 3446LANU est requise.

SYSTem:COMMunicate:LAN:GATeway "<adresse>"
SYSTem:COMMunicate:LAN:GATeway? [{CURRENT|STATIC}]

Attribue une passerelle par défaut à l'instrument. L'adresse IP spécifiée configure la passerelle par défaut qui permet à l'instrument de communiquer avec des systèmes qui ne se trouvent pas sur le sous-réseau local. Il s'agit donc de la passerelle par défaut où les paquets envoyés sont destinés à un périphérique qui ne se trouve pas sur le sous-réseau local, comme indiqué par le paramètre **Masque de sous-réseau**. Pour de plus amples informations, contactez votre administrateur réseau.

REMARQUE

Si vous modifiez ce paramètre, vous devez envoyer la commande **SYSTem:COMMunicate:LAN:UPDate** pour activer le nouveau paramètre.

Paramètre	Renvoi type
Commande : " nnn.nnn.nnn.nnn ". Valeur par défaut : "0.0.0.0".	"198.105.232.1"
Requête : {CURRENT STATIC}. Valeur par défaut : CURRENT.	
Définir l'adresse de passerelle par défaut :	
SYST:COMM:LAN:GATEWAY "198.105.232.1"	
SYST:COMM:LAN:UPD	

- **CURRENT**: renvoie l'adresse actuellement utilisée par l'instrument.
- **STATIC**: renvoie l'adresse statique de la mémoire non volatile. Cette adresse IP est utilisée si le protocole DHCP est désactivé ou indisponible.
- La commande **SYSTem:SECurity:IMMediate** définit ce paramètre sur sa valeur par défaut.
- Sur le modèle 34460A, l'option 34460A-LAN ou l'option 3446LANU est requise.
- Si le protocole DHCP est activé (**SYSTem:COMMunicate:LAN:DHCP ON**), la passerelle par défaut spécifiée n'est pas utilisée. Cependant, si le serveur DHCP ne parvient pas à attribuer une **adresse IP** valide, la passerelle configurée par défaut est utilisée.
- Ce paramètre est non volatile ; il n'est pas altéré par une remise sous tension, une réinitialisation de la configuration d'usine (***RST**) ou un prééglage de l'instrument (**SYSTem:PRESet**).

SYSTem:COMMunicate:LAN:HOSTname "<nom>"
SYSTem:COMMunicate:LAN:HOSTname? [{CURRent|STATic}]

Attribue un nom d'hôte à l'instrument. Un nom d'hôte est la partie hôte du nom du domaine qui est traduite en adresse IP. Si le système DNS dynamique est disponible sur votre réseau et que votre instrument utilise le protocole DHCP, le nom d'hôte est enregistré avec le service DNS dynamique à la mise sous tension. Si le protocole DHCP est activé (SYSTem:COMMunicate:LAN:DHCP ON), le serveur DHCP peut modifier le nom d'hôte spécifié.

REMARQUE

Si vous modifiez ce paramètre, vous devez envoyer la commande **SYSTem:COMMunicate:LAN:UPDate** pour activer le nouveau paramètre.

Paramètre	Renvoi type
Chaîne composée de 15 caractères au maximum. Doit commencer par une lettre (A-Z) Peut contenir des lettres, des chiffres (0 à 9) et les traits d'union (« - »). Valeur par défaut : « A-34460A-nnnnn » ou « A-34461A-nnnnn », où nnnnn correspond aux cinq derniers chiffres du numéro de série de l'instrument	« LAB1-34461A »
Définir un nom d'hôte : SYST:COMM:LAN:HOST "LAB1-DMM" SYST:COMM:LAN:UPD	

- S'il n'existe aucun nom d'hôte, une chaîne vide ("") est renvoyée.
- Sur le modèle 34460A, l'option 34460A-LAN ou l'option 3446LANU est requise.
- Pour la forme de requête, spécifiez "CURRent" (valeur par défaut) pour lire la valeur actuellement utilisée par l'instrument. Spécifiez « STATic » pour lire le nom d'hôte actuellement stocké dans la mémoire non volatile de l'instrument (n'est pas nécessairement le nom utilisé par l'instrument si DHCP est activé).
- Ce paramètre est non volatile ; il n'est pas altéré par une remise sous tension, une réinitialisation de la configuration d'usine (*RST) ou un préréglage de l'instrument (SYSTem:PRESet).
- Ce paramètre est défini sur la valeur par défaut lorsque l'instrument est expédié de l'usine et après l'exécution de la commande **SYSTem:SECurity:IMMediate**.

SYSTem:COMMunicate:LAN:IPADdress "<adresse>"

SYSTem:COMMunicate:LAN:IPADdress? [{CURRENT|STATic}]

Attribue une adresse IP statique à l'instrument. Si le protocole DHCP est activé (SYSTem:COMMunicate:LAN:DHCP ON), l'adresse IP statique spécifiée n'est pas utilisée. Pour de plus amples informations, contactez votre administrateur réseau.

REMARQUE

Si vous modifiez ce paramètre, vous devez envoyer la commande **SYSTem:COMMunicate:LAN:UPDate** pour activer le nouveau paramètre.

Paramètre	Renvoi type
Commande : "nnn.nnn.nnn.nnn"	"169.254.149.35"
Requête : {CURRENT STATic}. Valeur par défaut : CURRENT.	
Définir une adresse IP statique :	
SYST:COMM:LAN:IPAD "169.254.149.35"	
SYST:COMM:LAN:UPD	

- La commande **SYSTem:SECurity:IMMEDIATE** définit ce paramètre sur sa valeur par défaut.
- Sur le modèle 34460A, l'option 34460A-LAN ou l'option 3446LANU est requise.
- Pour la forme de requête, spécifiez "CURRENT" (valeur par défaut) pour lire la valeur actuellement utilisée par l'instrument. Spécifiez « STATic » pour lire la valeur actuellement stockée dans la mémoire non volatile de l'instrument (n'est pas nécessairement l'adresse utilisée par l'instrument si DHCP est activé).
- Ce paramètre est non volatile ; il n'est pas altéré par une remise sous tension, une réinitialisation de la configuration d'usine (*RST) ou un prééglage de l'instrument (SYSTem:PRESet).
- Ce paramètre est défini sur la valeur par défaut lorsque l'instrument est expédié de l'usine et après l'exécution de la commande **SYSTem:SECurity:IMMEDIATE**.

SYSTem:COMMunicate:LAN:MAC?

Renvoie l'adresse MAC (Media Access Control) de l'instrument sous la forme d'une chaîne ASCII composée de 12 caractères hexadécimaux (0-9 et A-F) entre guillemets.

REMARQUE Votre administrateur réseau peut avoir besoin de l'adresse MAC pour attribuer une adresse IP statique à ce périphérique.

Paramètre	Renvoi type
(aucun)	"0030D3001041"
Renvoyer l'adresse MAC :	
SYST:COMM:LAN:MAC?	

- Sur le modèle 34460A, l'option 34460A-LAN ou l'option 3446LANU est requise.
- L'adresse MAC porte également les noms suivants : adresse de la couche de liaison, adresse Ethernet (poste), LANIC ID ou adresse matérielle. Il s'agit d'une adresse non modifiable sur 48 bits attribué par le fabricant à chaque périphérique Internet unique.

SYSTem:COMMunicate:LAN:SMASk "<masque>"
SYSTem:COMMunicate:LAN:SMASk? [{CURRENT|STATic}]

Attribue un masque de sous-réseau à l'instrument pour déterminer si une adresse IP cliente se trouve sur le même sous-réseau local que lui. Lorsque l'adresse IP d'un client se trouve sur un sous-réseau différent, tous les paquets doivent être envoyés à la passerelle par défaut. Pour de plus amples informations, contactez votre administrateur réseau.

REMARQUE

Si vous modifiez ce paramètre, vous devez envoyer la commande **SYSTem:COMMunicate:LAN:UPDate** pour activer le nouveau paramètre.

Paramètre	Renvoi type
Commande : " nnn.nnn.nnn.nnn ". Valeur par défaut : "255.255.0.0".	"255.255.255.0"
Requête : {CURRENT STATic}. Valeur par défaut : CURRENT.	
Définir le masque de sous-réseau :	
SYST:COMM:LAN:SMAS "255.255.255.0"	
SYST:COMM:LAN:UPD	

- Sur le modèle 34460A, l'option 34460A-LAN ou l'option 3446LANU est requise.
- Si le protocole DHCP est activé (**SYSTem:COMMunicate:LAN:DHCP ON**), le masque de sous-réseau spécifié n'est pas utilisé. Cependant, si le serveur DHCP ne parvient pas à attribuer une adresse IP valide, l'instrument utilise le masque de sous-réseau Auto-IP.
- La valeur « 0.0.0.0 » ou « 255.255.255.255 » indique que la fonction de sous-réseau n'est pas utilisée.
- La commande **SYSTem:SECurity:IMMEDIATE** définit ce paramètre sur sa valeur par défaut.
- **CURRENT**: renvoie l'adresse actuellement utilisée par l'instrument.
- **STATic**: renvoie l'adresse statique de la mémoire non volatile. Cette adresse IP est utilisée si le protocole DHCP est désactivé ou indisponible.
- Ce paramètre est non volatile ; il n'est pas altéré par une remise sous tension, une réinitialisation de la configuration d'usine (***RST**) ou un pré réglage de l'instrument (**SYSTem:PRESet**).

SYSTem:COMMunicate:LAN:TELNet:PROMpt "<chaîne>"
SYSTem:COMMunicate:LAN:TELNet:PROMpt?

Configure l'invite de commandes qui s'affiche lorsque l'instrument communique via Telnet.

Paramètre	Renvoi type
Chaîne composée de 15 caractères au maximum	"Command>"
Par défaut, le numéro de modèle de l'instrument est sélectionné : 34460A> , 34461A> , 34465A> ou 34470A>	
Configurer l'invite de commandes :	
SYST:COMM:LAN:TELN:PROM "Command>"	

- Sur le modèle 34460A, l'option 34460A-LAN ou l'option 3446LANU est requise.
- L'instrument utilise le port 5024 du réseau local pour les sessions Telnet SCPI et le port 5025 pour les sessions sur socket SCPI.
- Les sessions Telnet démarrent généralement à partir d'un shell de l'ordinateur hôte :

```
telnet <adresse_IP> <port>
```

Par exemple :

```
telnet 169.254.4.10 5024
```

Pour quitter une session Telnet, appuyez sur <Ctrl-D>.

- Ce paramètre est non volatile ; il n'est pas altéré par une remise sous tension, une réinitialisation de la configuration d'usine (*RST) ou un pré réglage de l'instrument (SYSTem:PRESet).
- La commande SYSTem:SECurity:IMMediate définit ce paramètre sur sa valeur par défaut.

SYSTem:COMMunicate:LAN:TELNet:WMESsage "<chaîne>"
SYSTem:COMMunicate:LAN:TELNet:WMESsage?

Configure le message d'accueil qui s'affiche lorsque l'instrument communique via Telnet.

Paramètre	Renvoi type
Chaîne entre guillemets contenant jusqu'à 63 caractères. Valeur par défaut : « Welcome to Keysight's <numéro de modèle de l'instrument> Digital Multimeter » (Bienvenue dans le multimètre numérique <numéro de modèle de l'instrument> de Keysight)	« Welcome to the Telnet Session » (Bienvenue dans la session Telnet)
Configurer un message d'accueil :	
SYST:COMM:LAN:TELN:WMES "Welcome to the Telnet Session"	

- Sur le modèle 34460A, l'option 34460A-LAN ou l'option 3446LANU est requise.
- L'instrument utilise le port 5024 du réseau local pour les sessions Telnet SCPI et le port 5025 pour les sessions sur socket SCPI.
- Ce paramètre est non volatile ; il n'est pas altéré par une remise sous tension, une réinitialisation de la configuration d'usine (*RST) ou un préreglage de l'instrument (SYSTem:PRESet).
- La commande SYSTem:SECurity:IMMediate définit ce paramètre sur sa valeur par défaut.

SYSTem:COMMunicate:LAN:UPDate

Enregistre les modifications des paramètres du réseau local dans la mémoire non volatile et redémarre le pilote du réseau local avec les nouveaux paramètres.

Paramètre	Renvoi type
(aucun)	(aucun)
(voir ci-dessous)	

- Sur le modèle 34460A, l'option 34460A-LAN ou l'option 3446LANU est requise.
- Cette commande doit être envoyée après avoir modifié les paramètres DHCP, DNS, de la passerelle, du nom d'hôte, d'adresse IP, du masque de sous-réseau ou WINS.
- Effectuez toutes les modifications des paramètres du réseau local avant d'envoyer cette commande.

Exemple

L'exemple suivant illustre la configuration de l'instrument pour utiliser les paramètres réseau attribués statiquement.

```
SYST:COMM:LAN:DHCP OFF
SYST:COMM:LAN:DNS "198.105.232.4"
SYST:COMM:LAN:DNS2 "198.105.232.5"
SYST:COMM:LAN:GAT "198.105.232.1"
SYST:COMM:LAN:HOST "LAB1-DMM"
SYST:COMM:LAN:IPAD "198.105.232.101"
SYST:COMM:LAN:SMAS "255.255.255.0"
SYST:COMM:LAN:WINS "198.105.232.4"
SYST:COMM:LAN:WINS "198.105.232.5"
SYST:COMM:LAN:UPD
```

L'exemple suivant illustre la configuration de l'instrument pour revenir à l'utilisation du protocole DHCP.

```
SYST:COMM:LAN:DHCP ON
SYST:COMM:LAN:UPD
```

SYSTem:COMMunicate:LAN:WINS[{{1|2}}] "<adresse>"
SYSTem:COMMunicate:LAN:WINS[{{1|2}}]? [{{CURRENT|STATIC}}]

Attribue les adresses IP statiques des serveurs WINS (Windows Internet Name System). Une adresse de serveur principale et secondaire peut être affectée. Si le protocole DHCP est disponible et activé, il attribue automatiquement ces adresses de serveur. Ces adresses attribuées automatiquement sont prioritaires sur les adresses statiques affectées avec cette commande. Pour de plus amples informations, contactez votre administrateur réseau.

REMARQUE

Si vous modifiez ce paramètre, vous devez envoyer la commande **SYSTem:COMMunicate:LAN:UPDate** pour activer le nouveau paramètre.

Paramètre	Renvoi type
Commande : " nnn.nnn.nnn.nnn ". Valeur par défaut : "0.0.0.0".	"198.105.232.4"
Requête : {CURRENT STATIC}. Valeur par défaut : CURRENT.	
Définir une adresse WINS principale statique :	
SYST:COMM:LAN:WINS "198.105.232.4"	
SYST:COMM:LAN:UPD	

- Sur le modèle 34460A, l'option 34460A-LAN ou l'option 3446LANU est requise.
- Les adresses WINS sont stockées en mémoire volatile. Ils ne changent pas lorsque l'instrument est remis sous tension, après réinitialisation de la configuration d'usine (***RST**) ou après un pré réglage de l'instrument (**SYSTem:PRESet**).
- La commande **SYSTem:SECurity:IMMediate** définit ce paramètre sur sa valeur par défaut.
- **CURRENT**: renvoie l'adresse actuellement utilisée par l'instrument.
- **STATIC**: renvoie l'adresse statique de la mémoire non volatile. Cette adresse IP est utilisée si le protocole DHCP est désactivé ou indisponible.

SYSTem:USB:HOST:ENABLE {ON|1|OFF|0}

SYSTem:USB:HOST:ENABLE?

Désactive ou active le port hôte USB du panneau avant. La sécurité d'étalonnage doit être déverrouillée (**CALibration:SECure:STATe <code>,OFF**) avant d'envoyer cette commande.

Paramètre	Renvoi type
{ON 1 OFF 0}. Valeur par défaut : OFF.	0 (OFF) ou 1 (ON)
Désactiver le port hôte USB : CAL:SEC:STAT OFF,MY_CAL_CODE SYST:USB:HOST:ENAB OFF CAL:SEC:STAT ON	

- Cette fonctionnalité requiert l'option SEC sous licence. Cette option peut être commandée en usine ou sous forme d'option installée par le client. Pour de plus amples informations, reportez-vous à la section **Modèles et options**. Sans cette option, l'interface USB du panneau avant est toujours activée.
- Si le port hôte USB du panneau avant est désactivé, il ne peut pas être utilisé pour stocker ou charger des mesures, des fichiers de configuration, des préférences ou d'autres fichiers, ni pour effectuer une mise à jour du microprogramme.
- Ce paramètre est non volatile ; il n'est pas altéré par une remise sous tension, une réinitialisation de la configuration d'usine (***RST**) ou un préréglage de l'instrument (**SYSTem:PRESet**).

Commandes LOCK du sous-système SYSTEM

Ce sous-système verrouille et déverrouille les interface d'E/S de l'instrument, comme l'illustre l'exemple suivant :

État initial = déverrouillé, nombre = 0

```
(DEPUIS L'INTERFACE USB) SYST:LOCK:REQ? renvoie "1" (requête réussie)
```

État = verrouillé, nombre = 1

```
(DEPUIS L'INTERFACE GPIB) SYST:LOCK:REQ? renvoie la valeur « 0 » car l'interface USB est verrouillée
```

État = verrouillé, nombre = 1

```
(DEPUIS L'INTERFACE USB) SYST:LOCK:REQ? renvoie "1" (requête réussie)
```

État = verrouillé, nombre = 2

```
(DEPUIS L'INTERFACE USB) SYST:LOCK:REL
```

État = verrouillé, nombre = 1

```
(DEPUIS L'INTERFACE USB) SYST:LOCK:REL
```

État = déverrouillé, nombre = 0

Pour chaque requête de verrouillage réussie, un déverrouillage est nécessaire. Deux requêtes exigent deux déverrouillages.

Récapitulatif des commandes

SYSTEM:LOCK:NAME?

SYSTEM:LOCK:OWNER?

SYSTEM:LOCK:RELEASE

SYSTEM:LOCK:REQUEST?

SYSTem:LOCK:NAME?

Renvoie l'interface d'E/S utilisée par l'ordinateur effectuant la requête.

Paramètre	Renvoi type
(aucun)	"LAN169.254.149.35"
Voir l' exemple de verrouillage d'interface	

- Après avoir déterminé l'interface que vous utilisez, utilisez la commande **SYSTem:LOCK:OWNer?** pour déterminer l'interface verrouillée le cas échéant.
- Renvoie "USB", "VXI11", "GPIB" ou "LAN <Adresse IP>" ou "WEB<Adresse IP>" indiquant l'interface d'E/S utilisée par l'ordinateur effectuant la requête.

SYSTem:LOCK:OWNer?

Renvoie l'interface d'E/S actuellement verrouillée.

Paramètre	Renvoi type
(aucun)	"LAN169.254.149.35"
Voir l' exemple de verrouillage d'interface	

- Lorsqu'un verrouillage est actif, le bit 10 du registre de fonctionnement standard est actif (**STATus:OPERation:CONDition?**). Lorsque le système est déverrouillé sur toutes les interfaces d'E/S, ce bit est effacé.
- Renvoie "USB", "VXI11", "GPIB" ou "LAN <Adresse IP>" ou "WEB<Adresse IP>" indiquant l'interface d'E/S actuellement verrouillée. Si aucune interface n'est verrouillée, "NONE" est renvoyé.

SYSTem:LOCK:RELease

Diminue d'une unité le nombre de verrouillages et peut déverrouiller l'interface d'E/S à partir de laquelle la commande est exécutée.

Paramètre	Renvoi type
(aucun)	(aucun)
Voir l' exemple de verrouillage d'interface	

- Lorsqu'un verrouillage est actif, le bit 10 du registre de fonctionnement standard est actif (**STATus:OPERation:CONDition?**). Lorsque le système est déverrouillé sur toutes les interfaces d'E/S, ce bit est effacé.

SYSTem:LOCK:REQuest?

Demande le verrouillage de l'interface d'E/S active. Cette commande vous permet de verrouiller la configuration de l'instrument ou de partager l'instrument avec d'autres ordinateurs.

Paramètre	Renvoi type
(aucun)	+0 (refusé) ou +1 (accordé)
Voir l' exemple de verrouillage d'interface	

- Les requêtes de verrouillage peuvent être imbriquées ; chaque requête augmente le nombre de verrouillages d'une unité. Pour chaque requête, vous nécessitez un déverrouillage ([SYSTem:LOCK:RELease](#)) à partir de la même interface d'E/S.
- Les verrouillages sont gérés au niveau des interfaces d'E/S (USB, réseau local, etc.) ; vous êtes responsable de la coordination entre les threads et/ou les programmes sur cette interface.
- Lorsqu'une requête est accordée, seules les sessions d'E/S de l'interface actuelle peuvent modifier l'état de l'instrument. Vous pouvez uniquement demander l'état de l'instrument à partir d'autres interfaces d'E/S.
- Les sessions sur le réseau local sont automatiquement déverrouillées lorsqu'un réseau local est détecté.
- L'accord d'un verrouillage active le bit 10 du registre de fonctionnement standard ([STATus:OPERation:CONDition?](#)). De plus, le panneau avant complet de l'instrument, notamment la touche **Local**, est déverrouillée alors qu'un verrouillage est en place (le message "Front panel locked." (Panneau avant verrouillé.) s'affiche).

Commandes LICense du sous-système SYSTem

Ce sous-système gère les options sous licence de l'instrument.

Récapitulatif des commandes

SYSTem:LICense:CATalog?

SYSTem:LICense:DELeTe

SYSTem:LICense:DELeTe:ALL

SYSTem:LICense:DESCRiption?

SYSTem:LICense:ERRor?

SYSTem:LICense:ERRor:COUNT?

SYSTem:LICense:INSTall

SYSTem:LICense:CATalog?

Renvoie une liste séparée par des virgules des **options sous licence** installées. Seules les options pour lesquelles une licence est requise sont renvoyées. Si aucune option sous licence n'est détectée, la requête renvoie "".

Paramètre	Renvoi type
(aucun)	"LAN","SEC"
Renvoyer les options actuellement sous licence :	
SYST:LIC:CAT?	

- Cette requête renvoie une chaîne de caractères au format suivant :

34460A : "GPB","LAN","SEC"

34461A : "GPB","SEC"

34465A/70A : "GPB","SEC","DIG","MEM"

- Les options varient en fonction du modèle, comme **indiqué ici**.

SYSTem:LIcense:DElete "<nom_option>"

Supprime une licence et désactive les fonctionnalités associées.

REMARQUE

Si l'option de sécurité est installée, vous devez déverrouiller l'instrument à l'aide du code de sécurité pour exécuter cette commande.

Paramètre	Renvoi type
"LAN" ou "SEC" (34460A) "SEC" (34461A) "DIG", "MEM" ou "SEC" (34465A/70A)	(aucun)
Supprimer la licence du réseau local :	
SYST:LIC:DEL "LAN"	

- Les noms d'options valides sont des chaînes de caractères entre guillemets qui représentent les **options sous licence** installées. Les options installées peuvent être aisément identifiées à l'aide de la commande **SYSTem:LIcense:CATalog?**.
- L'exécution de cette commande entraîne le réglage de l'instrument avec ses **paramètres par défaut d'usine**.

SYSTem:LIcense:DElete:ALL

Supprime toutes les licences et désactive les fonctionnalités associées.

REMARQUE

Si l'option de sécurité est installée, vous devez déverrouiller l'instrument à l'aide du code de sécurité pour exécuter cette commande.

Paramètre	Renvoi type
(aucun)	(aucun)
Supprimer toutes les licences :	
SYST:LIC:DEL:ALL	

- L'exécution de cette commande entraîne le réglage de l'instrument avec les **paramètres par défaut d'usine**.

SYSTem:LIcense:DESCRiption? "<nom_option>"

Renvoie une description de l'option spécifiée, qu'elle soit ou non actuellement concédée sous licence.

Paramètre	Renvoi type
"LAN" ou "SEC" (34460A) "SEC" (34461A) "DIG", "MEM" ou "SEC" (34465A/70A)	"Enable instrument security" (Activer la sécurité de l'instrument)
Renvoyer une description pour l'option 34460A-LAN ou 3446LANU :	
SYST:LIC:DESC? "LAN"	

- Les noms d'options valides sont des chaînes de caractères entre guillemets qui représentent les **options sous licence** installées. Les options installées peuvent être aisément identifiées à l'aide de la commande **SYSTem:LIcense:CATalog?**.

SYSTem:LIcense:ERRor?

Renvoie une chaîne de toutes les erreurs générées par la commande **SYSTem:LIcense:INSTall**.

Paramètre	Renvoi type
(aucun)	#279File: MyFile.lic<CR><LF>[Ignored - The license file is not formatted correctly.]<CR><LF>
Renvoyer la chaîne de caractères d'erreur d'installation de la licence :	
SYST:LIC:ERR?	

- Cette chaîne de caractères ne doit pas contenir plus de 2 096 caractères.
- Renvoie un bloc de longueur définie contenant un texte ASCII sur plusieurs lignes, y compris les retours chariot et les retours à la ligne.

SYSTem:LIcense:ERRor:COUNt?

Renvoie le nombre d'erreurs des licences produites par la commande **SYSTem:LIcense:INSTall**.

Paramètre	Renvoi type
(aucun)	+0
Renvoyer le nombre d'erreurs de licence :	
SYST:LIC:ERR:COUN?	

SYSTem:LiCense:INSTall [{<dossier>|<fichier>}]

SYSTem:LiCense:INSTall? "<nom_option>"

Installe toutes les licences à partir d'un fichier de licence spécifié ou de tous les fichiers de licences dans le dossier spécifié.

REMARQUE

Si l'option de sécurité est installée, vous devez déverrouiller l'instrument à l'aide du code de sécurité pour exécuter cette commande.

Paramètre	Renvoi type
<p><dossier> peut être n'importe quel nom de dossier valide. Valeur par défaut : dossier racine d'un périphérique de stockage USB du panneau avant.</p> <p><fichier> peut être n'importe quel nom de fichier de licence valide.</p> <p>"LAN" ou "SEC" (34460A) "SEC" (34461A) "DIG", "MEM" ou "SEC" (34465A/70A)</p>	<p>0 (licence non installée) ou 1 (licence installée)</p>
<p>Installer les licences à partir de fichiers de licence dans le dossier \Licenses sur un périphérique de stockage USB du panneau avant :</p> <p>SYST:LIC:INST "USB:\Licenses"</p> <p>Installer les licences à partir du fichier « MyLicenses.lic » dans le dossier \Licenses sur un périphérique de stockage USB du panneau avant :</p> <p>SYST:LIC:INST "USB:\Licenses\MyLicenses.lic"</p> <p>Renvoyer l'état de la licence « LAN » :</p> <p>SYST:LIC:INST? "LAN"</p> <p>Réponse type : 0</p>	

- Les fichiers de licence doivent porter l'extension « .lic ».
- Le format de (<fichier>) est "[<disque>:<chemin>]<nom_de_fichier>" où <lecteur> peut être INTERNAL ou USB et <chemin> doit être le chemin d'accès complet au dossier.
 - INTERNAL spécifie le système de fichiers flash interne. USB désigne un périphérique de stockage USB du panneau avant.
 - Si <lecteur>:chemin n'est pas fourni, le dossier spécifié par la commande **MMEMory:CDIRectory** est utilisé.
 - Les chemins d'accès absolus commencent par « \ » ou « / » au niveau du répertoire racine <lecteur>.
 - Les noms de dossiers et de fichiers ne doivent pas contenir les caractères suivants : \ / : * ? " < > |
 - La combinaison du nom de dossier et de fichier ne doit pas dépasser 240 caractères.
 - Le dossier spécifié doit exister et ne peut pas être marqué comme un dossier masqué ou système.

- Le format d'un <dossier> est "<lecteur>:<chemin>", où <lecteur> peut être INTernal ou USB et <chemin> est le chemin d'accès complet au dossier.
 - INTernal spécifie le système de fichiers flash interne. USB désigne un périphérique de stockage USB du panneau avant.
 - Si <lecteur> est spécifié, <chemin> est interprété comme un chemin d'accès complet au dossier. Les chemins d'accès absolus commencent par « \ » ou « / » au niveau du répertoire racine <lecteur>.
 - Si <lecteur> est omis <chemin> désigne le dossier spécifié par **MMEMory:CDIRectory**. Les chemins relatifs ne doivent PAS commencer par \ ou /.
 - Le paramètre <dossier> ne doit pas contenir plus de 240 caractères.
 - Le dossier spécifié doit exister et ne peut pas être marqué comme un dossier masqué ou système.

Sous-système TRIGger

Le sous-système TRIGger configure le déclenchement qui contrôle l'acquisition des mesures.

REMARQUE Recommandation : Toutes les mesures déclenchées doivent être effectuées à l'aide d'une plage manuelle fixe appropriée. Aussi, désactivez la fonction de commutation automatique ([SENSe:]<fonction>:RANGe:AUTO OFF) ou définissez une plage fixe à l'aide de la commande [SENSe:]<fonction>:RANGe, **CONFigure** ou **MEASure**.

Récapitulatif des commandes

TRIGger:COUNT

TRIGger:DELay

TRIGger:DELay:AUTO

TRIGger:LEVel

TRIGger:SLOPe

TRIGger:SOURce

TRIGger:COUNT {<nombre>|MIN|MAX|DEF|INFinity}

TRIGger:COUNT? [{MIN|MAX|DEF}]

Sélectionne le nombre de déclenchements qui seront acceptés par l'instrument avant de retourner à l'état de déclenchement « inactif ».

Paramètre	Renvoi type
1 à 1 000 000 (1×10^6) ou continu (INFinity). Valeur par défaut : 1. (34460A/61A) 1 à 1 000 000 000 (1×10^9) ou continu (INFinity). Valeur par défaut : 1. (34465A/70A)	+1.00000000E+00 Pour un déclenchement continu (INFinity), la requête renvoie « 9.9E37 ».
<p>Renvoyer dix jeux de cinq mesures en tension continue à l'aide d'un déclenchement externe à front positif pour démarrer chaque jeu de mesures :</p> <pre>CONF:VOLT:DC SAMP:COUN 5 TRIG:COUN 10 TRIG:SOUR EXT;SLOP POS READ?</pre> <p>Réponse type : +1.00520000E+01, ... (50 mesures)</p>	

- Vous pouvez utiliser le nombre de déclenchements spécifiés conjointement avec un nombre d'échantillons (**SAMPle:COUNT**), qui définit le nombre d'échantillons à prélever par déclenchement. Dans ce cas, le nombre de mesures renvoyées correspond au nombre d'échantillons, multiplié par le nombre de déclenchements.
- Vous pouvez stocker jusqu'à 1 000 mesures dans la mémoire de mesures du modèle 34460A, 10 000 mesures dans celle du modèle 34461A, 50 000 mesures sur le modèle 34465A/70A (sans l'option MEM) ou 2 000 000 mesures sur le modèle 34465A/70A (avec l'option MEM). Si la mémoire de mesures est saturée, les nouvelles mesures remplacent les anciennes mesures enregistrées ; les mesures les plus récentes sont toujours conservées. Aucune erreur n'est générée. Toutefois, le bit Reading Mem Ovfl (bit 14) est défini dans le registre de conditions du registre des données douteuses (voir la section **Présentation du système d'état**).
- Un nombre de déclenchements variable n'est pas disponible sur le panneau avant. Si vous définissez le nombre de déclenchements, puis passez en mode local (panneau avant), l'instrument ignore le paramètre de nombre de déclenchements. Cependant, si vous retournez au mode de commande à distance, le nombre de déclenchements retourne à la valeur précédente que vous avez sélectionnée.
- Ce paramètre est défini à sa valeur par défaut après une réinitialisation de la configuration d'usine (***RST**) ou un préréglage de l'instrument (**SYSTem:PRESet**).

TRIGger:DElay {<secondes>|MIN|MAX|DEF}

TRIGger:DElay? [{MIN|MAX|DEF}]

Définit le retard entre le signal de déclenchement et la première mesure. Cela peut être utile dans les applications dans lesquelles vous souhaitez stabiliser l'entrée avant d'effectuer une mesure ou pour cadencer une rafale de mesures.

La sélection d'un retard de déclenchement spécifique entraîne la désactivation du retard de déclenchement automatique (**TRIGger:DElay:AUTO OFF**).

REMARQUE Pour les mesures alternatives (tension ou courant), il existe un rapport entre le paramètre de bande passante (**[SENSe:]VOLTage:AC:BANDwidth** ou **[SENSe:]CURRent:AC:BANDwidth** et le paramètre de retard de déclenchement par défaut. Ce retard s'assure qu'un temps de stabilisation suffisant est prévu pour la mesure en courant alternatif. Pour de plus amples informations, reportez-vous à la section **Retards de déclenchement automatiques**.

Paramètre	Renvoi type
0 à ~3 600 secondes (pas de ~1 µs), 1 s par défaut Valeur par défaut : 1 s. La valeur de pas pour les mesures en courant continu est d'environ 1 µs. La valeur de pas varie selon la bande passante de courant alternatif pour les mesures en courant alternatif.	+2.00000806E+00
Renvoyez cinq mesures en tension continue. Un retard de 2 secondes est prévu avant chaque mesure. CONF:VOLT:DC 10 SAMP:COUN 5 TRIG:DEL 2 READ? Réponse type : +4.27230000E+00,+4.27150000E+00,+4.27190000E+00,+4.27170000E+00,+4.27200000E+00	

- En raison de la quantification interne, le retard réel que vous définissez peut différer sensiblement de la valeur que vous avez spécifiée. L'incrément est d'environ 1 µs.
- Par défaut, **TRIGger:DElay:AUTO** est activé. L'instrument détermine automatiquement le retard selon la fonction, la plage et le temps d'intégration (voir **Retards de déclenchement automatiques**). Cependant, vous devrez éventuellement définir un retard plus long que le retard automatique pour les câbles longs ou les signaux à capacité ou impédance élevées.
- Si vous spécifiez un retard de déclenchement à l'aide de cette commande, il est utilisé pour *toutes* les fonctions (à l'exception de **CONTinuity** et **DIODe**) et plages. Les tests **CONTinuity** et **DIODe** ignorent le paramètre de retard de déclenchement.
- Si vous avez configuré l'instrument pour plusieurs mesures par déclenchement (**SAMPle:COUNT** > 1), le retard est introduit après le déclenchement et entre des mesures consécutives.
- L'instrument sélectionne le retard de déclenchement automatique après une réinitialisation de la configuration d'usine (***RST**) ou un préreglage de l'instrument (**SYSTem:PRESet**).

TRIGger:DElay:AUTO {ON|1|OFF|0}
TRIGger:DElay:AUTO?

Désactive ou active le retard de déclenchement automatique. Si cette commande est activée, l'instrument détermine le retard selon la fonction, la plage, et le temps d'intégration ou la bande passante.

Paramètre	Renvoi type
{ON 1 OFF 0}. Valeur par défaut : ON.	0 (OFF) ou 1 (ON)
Envoyez 5 mesures en tension continue avec un retard automatique entre chaque mesure. CONF:VOLT:DC 10 SAMP:COUN 5 TRIG:DEL 2 READ? Réponse type : +4.27230000E+00,+4.27150000E+00,+4.27190000E+00,+4.27170000E+00,+4.27200000E+00	

- La sélection d'un retard de déclenchement spécifique à l'aide de la commande **TRIGger:DElay** entraîne la désactivation du retard de déclenchement automatique.
- Ce paramètre est défini à sa valeur par défaut après une réinitialisation de la configuration d'usine (***RST**) ou un pré réglage de l'instrument (**SYSTem:PRESet**).

TRIGger:LEVel {<niveau>|MIN|MAX|DEF}
TRIGger:LEVel? [{MIN|MAX|DEF}]

Définit le niveau auquel un déclenchement se produit lorsqu'un déclenchement par niveau est activé (**TRIGger:SOURce** défini sur **INTernal**).

REMARQUE

Il est recommandé d'effectuer toutes les mesures déclenchées en utilisant une plage manuelle fixe appropriée. Aussi, désactivez la fonction de commutation automatique (**SENSe:<function>:RANGe:AUTO OFF**) ou définissez une plage fixe à l'aide de la commande **SENSe:<function>:RANGe**, **CONFigure** ou **MEASure**.

Paramètre	Renvoi type
<niveau> (voir les points d'énumération ci-dessous). Valeur par défaut : 0.	+2.00000000E+01
Configurez les mesures en tension continue, plage de 1 V, résolution de 0,1 mV. Sélectionnez la source de déclenchement interne Réglez le niveau de déclenchement sur 0,75 volts, pente positive. INIT place le compteur en mode « attente de déclenchement ».	
CONF:VOLT:DC 1,0.0001 TRIG:SOUR INT TRIG:LEV 0.75 TRIG:SLOP POS INIT	

- Concerne uniquement les modèles 34465A et 34470A et requiert l'option DIG.
- Uniquement pris en charge pour les mesures en tension alternative et en tension continue, en courant alternatif et en courant continu, de fréquence, de période, de résistance en 2 et 4 fils, de RTD et de température de thermistance. Pour les mesures de résistance et de température, la compensation de décalage et le mode basse puissance doivent être désactivés.
- Pour utiliser le niveau de déclenchement, vous devez sélectionner la source de déclenchement INTERNAL avec la commande **TRIGger:SOURce**.
- Si vous utilisez une grande ouverture (mode NPLC ou ouverture) et que le niveau de signal varie considérablement dans l'ouverture, une variation inattendue de l'amplitude de la mesure déclenchée par rapport au niveau de déclenchement spécifié.
- Ce paramètre est défini à sa valeur par défaut après une réinitialisation de la configuration d'usine (***RST**) ou un préréglage de l'instrument (**SYSTem:PRESet**).
- Spécifiez le *<niveau>* dans les unités fondamentales pour la fonction (volts, ohms, amps, hertz ou secondes). Le tableau ci-dessous présente les valeurs autorisées pour le *<niveau>* pour chaque fonction de mesure, plage et les bornes d'entrée (pour I CC et I CA).

Fonction de mesure	Plage/Bornes d'entrée	<i><niveau></i> Valeur du paramètre
V CC	Plages de 100 mV à 100 V, plage fixe	±120 % de la plage
	Plage de 1 000 V, plage fixe	±1 000 V
	Commutation de plage automatique	±1 000 V
I CC	Bornes de 3 A, plage fixe	±120 % de la plage
	Bornes de 3 A, commutation automatique de plage	±3,6 A
	Bornes de 10 A	±12 A
RESistance/FRESistance	Toutes les plages, plage fixe	0 à +120 % de la plage
	Commutation de plage automatique	0 à +1,2 GΩ
V CA	Plages de 100 mV à 100 V, plage fixe	0 à +120 % de la plage
	Plage de 750 V, plage fixe	0 à +1 000 V
	Commutation de plage automatique	0 à +1 000 V
I CA	Bornes de 3 A, plage fixe	0 à +120 % de la plage
	Bornes de 3 A, commutation automatique de plage	0 à +3,6 A
	Bornes de 10 A	0 à +12 A
FREQuency	*S/O	3 Hz à 300 kHz
PERiod	*S/O	3,33333333 μs à 0,333333333 s

*S/O = S/O = Sans objet.

Voir également

TRIGger:DElay

TRIGger:SOURce

TRIGger:SLOPe {POSitive|NEGative}

TRIGger:SLOPe?

Détermine si un instrument utilise le front montant (POS) ou descendant (NEG) du signal de déclenchement sur le connecteur BNC *Ext Trig* du panneau arrière lorsque le déclenchement externe est sélectionné ou le front montant ou descendant du signal d'entrée lorsque le déclenchement par niveau est sélectionné (le niveau de déclenchement concerne uniquement les modèles 34465A et 34470A).

Paramètre	Renvoi type
{POSitive NEGative}. Valeur par défaut : NEG	POS ou NEG
Renvoyer dix jeux de cinq mesures en tension continue à l'aide d'un déclenchement externe à front positif pour démarrer chaque jeu de mesures : CONF:VOLT:DC SAMP:COUN 5 TRIG:COUN 10 TRIG:SOUR EXT;SLOP POS READ? Réponse type : +1.00520000E+01, ... (50 mesures)	

- Sur le modèle 34460A, l'option 34460A-LAN ou l'option 3446LANU est requise.
- Ce paramètre est défini à sa valeur par défaut après une réinitialisation de la configuration d'usine (*RST) ou un pré réglage de l'instrument (SYSTem:PRESet).

TRIGger:SOURce {IMMEDIATE|EXTERNAL|BUS|INTERNAL}

TRIGger:SOURce?

Sélectionne la source de déclenchement des mesures.

REMARQUE

Il est recommandé d'effectuer toutes les mesures déclenchées en utilisant une plage manuelle fixe appropriée. Aussi, désactivez la fonction de commutation automatique (**SENSe:<function>:RANGe:AUTO OFF**) ou définissez une plage fixe à l'aide de la commande **SENSe:<function>:RANGe**, **CONFigure** ou **MEASure**.

Source	Description
IMMediate	Le signal de déclenchement est toujours présent. Lorsque vous placez l'instrument à l'état « en attente de déclenchement », le déclenchement est émis immédiatement.
BUS	L'instrument est déclenché par la commande *TRG sur l'interface de commande à distance une fois le multimètre à l'état « en attente de déclenchement ».
EXTernal	L'instrument accepte les déclenchements matériels appliqués à l'entrée Ext Trig du panneau arrière et relève le nombre de mesures spécifiées (SAMPle:COUNt) chaque fois qu'une impulsion TTL indiquée par la commande OUTPut:TRIGger:SLOPe est reçue. Si l'instrument reçoit un déclenchement externe avant d'être prêt, il met n déclenchement en mémoire tampon.
INTernal	La source INTernal est disponible pour les modèles 34465A et 34470A avec l'option DIG uniquement, et inclut la fonction de déclenchement par niveau. Pour déclencher des acquisitions sur le signal d'entrée, sélectionnez INTernal pour la source et définissez le niveau et la pente avec les commandes TRIGger:LEVel et TRIGger:SLOPe .

Paramètre	Renvoi type
{IMMediate EXTernal BUS INTernal}. Valeur par défaut : IMMediate.	IMM, EXT ou BUS
<p>Renvoyer dix jeux de cinq mesures en tension continue à l'aide d'un déclenchement externe à front positif pour démarrer chaque jeu de mesures :</p> <pre>CONF:VOLT:DC SAMP:COUN 5 TRIG:COUN 10 TRIG:SOUR EXT;SLOP POS READ?</pre> <p>Réponse type : +1.00520000E+01, ... (50 mesures)</p>	

- Sur le modèle 34460A, EXTernal requiert l'option 34460-LAN ou 3446LANU.
- Après avoir sélectionné la source de déclenchement, vous devez placer l'instrument à l'état « en attente de déclenchement » en envoyant la commande **INITiate** ou **READ?**. Un déclenchement ne sera accepté par la source de déclenchement sélectionnée que si l'instrument est à l'état « en attente de déclenchement ».
- Ce paramètre est défini à sa valeur par défaut après une réinitialisation de la configuration d'usine (***RST**) ou un préreglage de l'instrument (**SYSTem:PRESet**).
- Recommandation : Toutes les mesures déclenchées doivent être effectuées à l'aide d'une plage manuelle fixe appropriée. Aussi, désactivez la fonction de commutation automatique (**[SENSe:]<fonction>:RANGe:AUTO OFF**) ou définissez une plage fixe à l'aide de la commande **[SENSe:]<fonction>:RANGe**, **CONFigure** ou **MEASure**.

- Ce paramètre est défini à sa valeur par défaut après une réinitialisation de la configuration d'usine (*RST) ou un pré réglage de l'instrument (SYSTem:PRESet).

Aide-mémoire des commandes

Assurez-vous de lire la section **Conventions syntaxiques de langage**. Les commandes ou les paramètres affichés en **bleu** concernent uniquement les modèles 34465A/70A. L'ensemble des autres paramètres et commandes s'appliquent à tous les autres multimètres numériques série Truevolt.

Commandes de configuration

CONFigure?

CONFigure:CAPacitance [{<plage>|AUTO|MIN|MAX|DEF} [, {<résolution>|MIN|MAX|DEF}]]

CONFigure:CONTInuity

CONFigure:CURRent:{AC|DC} [{<plage>|AUTO|MIN|MAX|DEF} [, {<résolution>|MIN|MAX|DEF}]]

CONFigure:DIODE

CONFigure:{FREQuency|PERiod} [{<plage>|MIN|MAX|DEF} [, {<résolution>|MIN|MAX|DEF}]]

CONFigure:{RESistance|FRESistance} [{<plage>|AUTO|MIN|MAX|DEF} [, {<résolution>|MIN|MAX|DEF}]]

CONFigure:TEMPerature [{FRTD|RTD|FTHermistor|THERmistor|TCouple|DEFault} [, {<type>|DEFault} [, 1 , {<résolution>|MIN|MAX|DEF}]]]]

CONFigure[:VOLTage]:{AC|DC} [{<plage>|AUTO|MIN|MAX|DEF} [, {<résolution>|MIN|MAX|DEF}]]

CONFigure[:VOLTage][:DC]:RATio [{<plage>|AUTO|MIN|MAX|DEF} [, {<résolution>|MIN|MAX|DEF}]]

Commandes de mesure

MEASure:CAPacitance? [{<plage>|AUTO|MIN|MAX|DEF} [, {<résolution>|MIN|MAX|DEF}]]

MEASure:CONTInuity?

MEASure:CURRent:{AC|DC}? [{<plage>|AUTO|MIN|MAX|DEF} [, {<résolution>|MIN|MAX|DEF}]]

MEASure:DIODE?

MEASure:{FREQuency|PERiod}? [{<plage>|MIN|MAX|DEF} [, {<résolution>|MIN|MAX|DEF}]]

MEASure:{RESistance|FRESistance}? [{<plage>|AUTO|MIN|MAX|DEF} [, {<résolution>|MIN|MAX|DEF}]]

MEASure:TEMPerature? [{FRTD|RTD|FTHermistor|THERmistor|TCouple|DEFault} [, {<type>|DEFault} [, 1 , {<résolution>|MIN|MAX|DEF}]]]]

MEASure[:VOLTage]:{AC|DC}? [{<plage>|AUTO|MIN|MAX|DEF} [, {<résolution>|MIN|MAX|DEF}]]

MEASure[:VOLTage][:DC]:RATio? [{<plage>|AUTO|MIN|MAX|DEF} [, {<résolution>|MIN|MAX|DEF}]]

Commandes de configuration des mesures

[SENSe:]FUNCTion[:ON] "<fonction>"

[SENSe:]FUNCTion[:ON]?

Commandes de configuration de la tensions alternative, de la tension continue et du rapport de tension continue

```

CONFigure[:VOLTage]:{AC|DC} [{<plage>|AUTO|MIN|MAX|DEF} [, {<résolution>|MIN|MAX|DEF}]]
CONFigure[:VOLTage][:DC]:RATio [{<plage>|AUTO|MIN|MAX|DEF} [, {<résolution>|MIN|MAX|DEF}]]
CONFigure?

[SENSe:]VOLTage:AC:BANDwidth {<filtre>|MIN|MAX|DEF}
[SENSe:]VOLTage:AC:BANDwidth? [{MIN|MAX|DEF}]

[SENSe:]VOLTage:{AC|DC}:NULL[:STATe] {OFF|ON}
[SENSe:]VOLTage:{AC|DC}:NULL[:STATe]?

[SENSe:]VOLTage:{AC|DC}:NULL:VALue {<valeur>|MIN|MAX|DEF}
[SENSe:]VOLTage:{AC|DC}:NULL:VALue? [{MIN|MAX|DEF}]

[SENSe:]VOLTage:{AC|DC}:NULL:VALue:AUTO {OFF|ON}
[SENSe:]VOLTage:{AC|DC}:NULL:VALue:AUTO?

[SENSe:]VOLTage:{AC|DC}:RANGe {<plage>|MIN|MAX|DEF}
[SENSe:]VOLTage:{AC|DC}:RANGe? [{MIN|MAX|DEF}]

[SENSe:]VOLTage:{AC|DC}:RANGe:AUTO {OFF|ON|ONCE}
[SENSe:]VOLTage:{AC|DC}:RANGe:AUTO?

[SENSe:]VOLTage:AC:SECondary {"OFF"|"CALCulate:DATA"|"FREQuency"|"VOLTage[:DC]"}
[SENSe:]VOLTage:AC:SECondary?

[SENSe:]VOLTage[:DC]:APERture {<secondes>|MIN|MAX|DEF}
[SENSe:]VOLTage[:DC]:APERture? [{MIN|MAX|DEF}]

[SENSe:]VOLTage[:DC]:APERture:ENABled {OFF|ON}
[SENSe:]VOLTage[:DC]:APERture:ENABled?

[SENSe:]VOLTage[:DC]:IMPedance:AUTO {OFF|ON}
[SENSe:]VOLTage[:DC]:IMPedance:AUTO?

[SENSe:]VOLTage[:DC]:NPLC {<PLC>|MIN|MAX|DEF}
[SENSe:]VOLTage[:DC]:NPLC? [{MIN|MAX|DEF}]

[SENSe:]VOLTage[:DC]:RATio:SECondary {"OFF"|"CALCulate:DATA"|"SENSe:DATA"}
[SENSe:]VOLTage[:DC]:RATio:SECondary?

[SENSe:]VOLTage[:DC]:RESolution {<résolution>|MIN|MAX|DEF}
[SENSe:]VOLTage[:DC]:RESolution? [{MIN|MAX|DEF}]

[SENSe:]VOLTage[:DC]:SECondary {"OFF"|"CALCulate:DATA"|"VOLTage:AC"|"PTPeak"}
[SENSe:]VOLTage[:DC]:SECondary?

[SENSe:]VOLTage[:DC]:ZERO:AUTO {OFF|ON|ONCE}
[SENSe:]VOLTage[:DC]:ZERO:AUTO?

```

Commandes de configuration de la résistance à 2 et 4 fils

```
CONFigure:{RESistance|FRESistance} [{<plage>|AUTO|MIN|MAX|DEF} [, {<résolution>|MIN|MAX|DEF}]]
```

```
CONFigure?
```

```
[SENSe:]{RESistance|FRESistance}:APERTure {<secondes>|MIN|MAX|DEF}
```

```
[SENSe:]{RESistance|FRESistance}:APERTure? [{MIN|MAX|DEF}]
```

```
[SENSe:]{RESistance|FRESistance}:APERTure:ENABled {OFF|ON}
```

```
[SENSe:]{RESistance|FRESistance}:APERTure:ENABled?
```

```
[SENSe:]{RESistance|FRESistance}:NPLC {<PLC>|MIN|MAX|DEF}
```

```
[SENSe:]{RESistance|FRESistance}:NPLC? [{MIN|MAX|DEF}]
```

```
[SENSe:]{RESistance|FRESistance}:NULL[:STATe] {OFF|ON}
```

```
[SENSe:]{RESistance|FRESistance}:NULL[:STATe]?
```

```
[SENSe:]{RESistance|FRESistance}:NULL:VALue {<valeur>|MIN|MAX|DEF}
```

```
[SENSe:]{RESistance|FRESistance}:NULL:VALue? [{MIN|MAX|DEF}]
```

```
[SENSe:]{RESistance|FRESistance}:NULL:VALue:AUTO {OFF|ON}
```

```
[SENSe:]{RESistance|FRESistance}:NULL:VALue:AUTO?
```

```
[SENSe:]{RESistance|FRESistance}:OCOMpensated {OFF|ON}
```

```
[SENSe:]{RESistance|FRESistance}:OCOMpensated?
```

```
[SENSe:]{RESistance|FRESistance}:POWER:LIMit[:STATe] {OFF|ON}
```

```
[SENSe:]{RESistance|FRESistance}:POWER:LIMit[:STATe]?
```

```
[SENSe:]{RESistance|FRESistance}:RANGe {<plage>|MIN|MAX|DEF}
```

```
[SENSe:]{RESistance|FRESistance}:RANGe? [{MIN|MAX|DEF}]
```

```
[SENSe:]{RESistance|FRESistance}:RANGe:AUTO {OFF|ON|ONCE}
```

```
[SENSe:]{RESistance|FRESistance}:RANGe:AUTO?
```

```
[SENSe:]{RESistance|FRESistance}:RESolution {<résolution>|MIN|MAX|DEF}
```

```
[SENSe:]{RESistance|FRESistance}:RESolution? [{MIN|MAX|DEF}]
```

```
[SENSe:]{FRESistance|RESistance}:SECOndary {"OFF"|"CALCulate:DATA"}
```

```
[SENSe:]{FRESistance|RESistance}:SECOndary?
```

```
[SENSe:]RESistance:ZERO:AUTO {OFF|ON|ONCE}
```

```
[SENSe:]RESistance:ZERO:AUTO?
```

Commandes de configuration du courant alternatif et du courant continu

CONFigure:CURRent:{AC|DC} [{<plage>|AUTO|MIN|MAX|DEF} [, {<résolution>|MIN|MAX|DEF}]]

CONFigure?

[SENSe:]CURRent:AC:BANDwidth {<filtre>|MIN|MAX|DEF}

[SENSe:]CURRent:AC:BANDwidth? [{MIN|MAX|DEF}]

[SENSe:]CURRent:{AC|DC}:NULL[:STATe] {OFF|ON}

[SENSe:]CURRent:{AC|DC}:NULL[:STATe]?

[SENSe:]CURRent:{AC|DC}:NULL:VALue {<valeur>|MIN|MAX|DEF}

[SENSe:]CURRent:{AC|DC}:NULL:VALue? [{MIN|MAX|DEF}]

[SENSe:]CURRent:{AC|DC}:NULL:VALue:AUTO {OFF|ON}

[SENSe:]CURRent:{AC|DC}:NULL:VALue:AUTO?

[SENSe:]CURRent:{AC|DC}:RANGe {<plage>|MIN|MAX|DEF}

[SENSe:]CURRent:{AC|DC}:RANGe? [{MIN|MAX|DEF}]

[SENSe:]CURRent:{AC|DC}:RANGe:AUTO {OFF|ON|ONCE}

[SENSe:]CURRent:{AC|DC}:RANGe:AUTO?

[SENSe:]CURRent:{AC|DC}:TERMinals {3|10}

[SENSe:]CURRent:{AC|DC}:TERMinals?

[SENSe:]CURRent:AC:SECondary {"OFF"|"CALCulate:DATA"|"FREQuency"|"CURRent[:DC]"}

[SENSe:]CURRent:AC:SECondary?

[SENSe:]CURRent[:DC]:APERTure {<secondes>|MIN|MAX|DEF}

[SENSe:]CURRent[:DC]:APERTure? [{MIN|MAX|DEF}]

[SENSe:]CURRent[:DC]:APERTure:ENABled{OFF|ON}

[SENSe:]CURRent[:DC]:APERTure:ENABled?

[SENSe:]CURRent[:DC]:NPLC {<PLC>|MIN|MAX|DEF}

[SENSe:]CURRent[:DC]:NPLC? [{MIN|MAX|DEF}]

[SENSe:]CURRent[:DC]:RESolution {<résolution>|MIN|MAX|DEF}

[SENSe:]CURRent[:DC]:RESolution? [{MIN|MAX|DEF}]

[SENSe:]CURRent[:DC]:SECondary {"OFF"|"CALCulate:DATA"|"CURRent:AC"|"PTPeak"}

[SENSe:]CURRent[:DC]:SECondary?

[SENSe:]CURRent[:DC]:ZERO:AUTO {OFF|ON|ONCE}

[SENSe:]CURRent[:DC]:ZERO:AUTO?

[SENSe:]CURRent:SWITCh:MODE {FAST|CONTInuous}

[SENSe:]CURRent:SWITCh:MODE?

Commandes de configuration de la capacité

CONFigure:CAPacitance [{<plage>|AUTO|MIN|MAX|DEF} [, {<résolution>|MIN|MAX|DEF}]]

CONFigure?

[SENSe:]CAPacitance:NULL[:STATe]{OFF|ON}

[SENSe:]CAPacitance:NULL[:STATe]?

[SENSe:]CAPacitance:NULL:VALue {<valeur>|MIN|MAX|DEF}

[SENSe:]CAPacitance:NULL:VALue? [{MIN|MAX|DEF}]

[SENSe:]CAPacitance:NULL:VALue:AUTO {OFF|ON}

[SENSe:]CAPacitance:NULL:VALue:AUTO?

[SENSe:]CAPacitance:RANGe {<plage>|MIN|MAX|DEF}

[SENSe:]CAPacitance:RANGe? [{MIN|MAX|DEF}]

[SENSe:]CAPacitance:RANGe:AUTO {OFF|ON|ONCE}

[SENSe:]CAPacitance:RANGe:AUTO?

[SENSe:]CAPacitance:SECondary {"OFF"|"CALCulate:DATA"}

[SENSe:]CAPacitance:SECondary?

Commandes de configuration de la température

CONFigure:TEMPerature [{FRTD|RTD|FTHermistor|THERmistor|TCouple|DEFault} [, {<type>|DEFault} [, 1 , {<résolution>|MIN|MAX|DEF}]]]]

CONFigure?

[SENSe:]TEMPerature:APERture {<secondes>|MIN|MAX|DEF}

[SENSe:]TEMPerature:APERture? [{MIN|MAX|DEF}]

[SENSe:]TEMPerature:APERture:ENABled {OFF|ON}

[SENSe:]TEMPerature:APERture:ENABled?

[SENSe:]TEMPerature:NPLC {<PLC>|MIN|MAX|DEF}

[SENSe:]TEMPerature:NPLC? [{MIN|MAX|DEF}]

[SENSe:]TEMPerature:NULL[:STATe] {OFF|ON}

[SENSe:]TEMPerature:NULL[:STATe]?

[SENSe:]TEMPerature:NULL:VALue {<valeur>|MIN|MAX|DEF}

[SENSe:]TEMPerature:NULL:VALue? [{MIN|MAX|DEF}]

[SENSe:]TEMPerature:NULL:VALue:AUTO {OFF|ON}

[SENSe:]TEMPerature:NULL:VALue:AUTO?

[SENSe:]TEMPerature:SECondary {"OFF"|"CALCulate:DATA"|"SENSe:DATA"}

[SENSe:]TEMPerature:SECondary?

[SENSe:]TEMPerature:TRANSDucer:{FRTD|RTD}:OCOMpensated {OFF|ON}

[SENSe:]TEMPerature:TRANSDucer:{FRTD|RTD}:OCOMpensated?

[SENSe:]TEMPerature:TRANSDucer:{FRTD|RTD}:POWER:LIMit[:STATe] {OFF|ON}

[SENSe:]TEMPerature:TRANSDucer:{FRTD|RTD}:POWER:LIMit[:STATe]?

[SENSe:]TEMPerature:TRANSDucer:{FRTD|RTD}:RESistance[:REFerence] {<référence>|MIN|MAX|DEF}

[SENSe:]TEMPerature:TRANSDucer:{FRTD|RTD}:RESistance[:REFerence]? [{MIN|MAX|DEF}]

[SENSe:]TEMPerature:TRANSDucer:{FTHermistor|THERmistor}:POWER:LIMit[:STATe] {OFF|ON}

[SENSe:]TEMPerature:TRANSDucer:{FTHermistor|THERmistor}:POWER:LIMit[:STATe]?

[SENSe:]TEMPerature:TRANSDucer:TCouple:CHECK {OFF|ON}

[SENSe:]TEMPerature:TRANSDucer:TCouple:CHECK?

Référence de programmation SCPI

```
[SENSe:]TEMPerature:TRANsdUCer:TCouple:RJUNction {<température>|MIN|MAX|DEF}
[SENSe:]TEMPerature:TRANsdUCer:TCouple:RJUNction? [{MIN|MAX|DEF}]

[SENSe:]TEMPerature:TRANsdUCer:TCouple:RJUNction:OFFSet:ADJust {<température>|MIN|MAX|DEF}
[SENSe:]TEMPerature:TRANsdUCer:TCouple:RJUNction:OFFSet:ADJust? [{MIN|MAX|DEF}]

[SENSe:]TEMPerature:TRANsdUCer:TCouple:RJUNction:TYPE {INTERNAL|FIXed}
[SENSe:]TEMPerature:TRANsdUCer:TCouple:RJUNction:TYPE?

[SENSe:]TEMPerature:TRANsdUCer:TCouple:TYPE {E|J|K|N|R|T}
[SENSe:]TEMPerature:TRANsdUCer:TCouple:TYPE?

[SENSe:]TEMPerature:TRANsdUCer:TYPE {FRTD|RTD|FTHermistor|THERmistor|TCouple}
[SENSe:]TEMPerature:TRANsdUCer:TYPE?

[SENSe:]TEMPerature:ZERO:AUTO {OFF|ON|ONCE}
[SENSe:]TEMPerature:ZERO:AUTO?

UNIT:TEMPerature {C|F|K}
UNIT:TEMPerature?
```

Commandes de configuration de la fréquence/période

```
CONFigure:{FREQuency|PERiod} [{<plage>|MIN|MAX|DEF} [, {<résolution>|MIN|MAX|DEF}]]
CONFigure?

[SENSe:]{FREQuency|PERiod}:APERTure {<secondes>|MIN|MAX|DEF}
[SENSe:]{FREQuency|PERiod}:APERTure? [{MIN|MAX|DEF}]

[SENSe:]{FREQuency|PERiod}:NULL[::STATe] {OFF|ON}
[SENSe:]{FREQuency|PERiod}:NULL[::STATe]?

[SENSe:]{FREQuency|PERiod}:NULL:VALue {<valeur>|MIN|MAX|DEF}
[SENSe:]{FREQuency|PERiod}:NULL:VALue? [{MIN|MAX|DEF}]

[SENSe:]{FREQuency|PERiod}:NULL:VALue:AUTO {OFF|ON}
[SENSe:]{FREQuency|PERiod}:NULL:VALue:AUTO?

[SENSe:]{FREQuency|PERiod}:RANGe:LOWer{<fréq>|MIN|MAX|DEF}
[SENSe:]{FREQuency|PERiod}:RANGe:LOWer?

[SENSe:]{FREQuency|PERiod}:TIMEout:AUTO {OFF|ON}

[SENSe:]{FREQuency|PERiod}:VOLTage:RANGe {<plage>|MIN|MAX|DEF}
[SENSe:]{FREQuency|PERiod}:VOLTage:RANGe? [{MIN|MAX|DEF}]

[SENSe:]{FREQuency|PERiod}:VOLTage:RANGe:AUTO {OFF|ON|ONCE}
[SENSe:]{FREQuency|PERiod}:VOLTage:RANGe:AUTO?

[SENSe:]FREQuency:SECondary {"OFF"|"CALCulate:DATA"|"PERiod"|"VOLTage:AC"}
[SENSe:]FREQuency:SECondary?

[SENSe:]PERiod:SECondary {"OFF"|"CALCulate:DATA"|"FREQuency"|"VOLTage:AC"}
[SENSe:]PERiod:SECondary?
```

Commandes de configuration de la continuité et des diodes

```
CONFigure:CONTinuity
CONFigure:DIODE
```

Commandes de mesure secondaire

```
[SENSe:]CAPacitance:SECondary {"OFF"|"CALCulate:DATA"}
[SENSe:]CAPacitance:SECondary?

[SENSe:]CURRent:AC:SECondary {"OFF"|"CALCulate:DATA"|"FREQuency"|"CURRent[:DC]"}
[SENSe:]CURRent:AC:SECondary?

[SENSe:]CURRent[:DC]:SECondary {"OFF"|"CALCulate:DATA"|"CURRent:AC"|"PTPeak"}
[SENSe:]CURRent[:DC]:SECondary?

[SENSe:]DATA2?

[SENSe:]DATA2:CLEar[:IMMediate]

[SENSe:]{FREStance|RESistance}:SECondary {"OFF"|"CALCulate:DATA"}
[SENSe:]{FREStance|RESistance}:SECondary?

[SENSe:]FREQuency:SECondary {"OFF"|"CALCulate:DATA"|"PERiod"|"VOLTage:AC"}
[SENSe:]PERiod:SECondary {"OFF"|"CALCulate:DATA"|"FREQuency"|"VOLTage:AC"}

[SENSe:]TEMPerature:SECondary {"OFF"|"CALCulate:DATA"|"SENSe:DATA"}
[SENSe:]TEMPerature:SECondary?

[SENSe:]VOLTage:AC:SECondary {"OFF"|"CALCulate:DATA"|"FREQuency"|"VOLTage[:DC]"}
[SENSe:]VOLTage:AC:SECondary?

[SENSe:]VOLTage[:DC]:RATio:SECondary {"OFF"|"CALCulate:DATA"|"SENSe:DATA"}
[SENSe:]VOLTage[:DC]:RATio:SECondary?

[SENSe:]VOLTage[:DC]:SECondary {"OFF"|"CALCulate:DATA"|"VOLTage:AC"|"PTPeak"}
[SENSe:]VOLTage[:DC]:SECondary?
```

Commandes de configuration diverses

```
ROUTe:TERMinals?
```

Commandes d'échantillonnage

SAMPlE:COUNt {<nombre>|MIN|MAX|DEF}
SAMPlE:COUNt? [{MIN|MAX|DEF}]

SAMPlE:COUNt:PRETrigger {<nombre>|MIN|MAX|DEF}
SAMPlE:COUNt:PRETrigger? [{MIN|MAX|DEF}]

SAMPlE:SOURce {IMMediate|TImEr}
SAMPlE:SOURce?

SAMPlE:TImEr {<intervalle>|MIN|MAX|DEF}
SAMPlE:TImEr? [{MIN|MAX|DEF}]

Commandes de déclenchement

ABORt

INITiate[:IMMediate]

OUTPut:TRIGger:SLOPe {POSitive|NEGative}
OUTPut:TRIGger:SLOPe?

READ?

SAMPlE:COUNt {<nombre>|MIN|MAX|DEF}
SAMPlE:COUNt? [{MIN|MAX|DEF}]

SAMPlE:COUNt:PRETrigger {<nombre>|MIN|MAX|DEF}
SAMPlE:COUNt:PRETrigger? [{MIN|MAX|DEF}]

*TRG

TRIGger:COUNt {<nombre>|MIN|MAX|DEF|INFinity}
TRIGger:COUNt? [{MIN|MAX|DEF}]

TRIGger:DELAy {<secondes>|MIN|MAX|DEF}
TRIGger:DELAy? [{MIN|MAX|DEF}]

TRIGger:DELAy:AUTO {OFF|ON}
TRIGger:DELAy:AUTO?

TRIGger:LEVel {<niveau>|MIN|MAX|DEF}
TRIGger:LEVel? [{MIN|MAX|DEF}]

TRIGger:SLOPe {POSitive|NEGative}
TRIGger:SLOPe?

TRIGger:SOURce {IMMediate|EXTErnal|BUS|INTernAl}
TRIGger:SOURce?

Commandes (mathématiques) de calcul

Générales

CALCulate:CLEar[:IMMediate]

Histogramme

CALCulate:TRANSform:HISTogram:ALL?

CALCulate:TRANSform:HISTogram:CLEar[:IMMediate]

CALCulate:TRANSform:HISTogram:COUNT?

CALCulate:TRANSform:HISTogram:DATA?

CALCulate:TRANSform:HISTogram:POINts {<valeur>|MIN|MAX|DEF}

CALCulate:TRANSform:HISTogram:POINts? [{MIN|MAX|DEF}]

CALCulate:TRANSform:HISTogram:RANGe:AUTO {OFF|ON}

CALCulate:TRANSform:HISTogram:RANGe:AUTO?

CALCulate:TRANSform:HISTogram:RANGe:{LOWer|UPPer} {<valeur>|MIN|MAX|DEF}

CALCulate:TRANSform:HISTogram:RANGe:{LOWer|UPPer}? [{MIN|MAX|DEF}]

CALCulate:TRANSform:HISTogram[:STATe] {OFF|ON}

CALCulate:TRANSform:HISTogram[:STATe]?

Test de limites

CALCulate:LIMit:CLEar[:IMMediate]

CALCulate:LIMit:{LOWer|UPPer}[:DATA] {<valeur>|MIN|MAX|DEF}

CALCulate:LIMit:{LOWer|UPPer}[:DATA]? [{MIN|MAX|DEF}]

CALCulate:LIMit[:STATe] {OFF|ON}

CALCulate:LIMit[:STATe]?

Réglage d'échelle

CALCulate:SCALE:DB:REFerence {<référence>|MIN|MAX|DEF}

CALCulate:SCALE:DB:REFerence? [{MIN|MAX|DEF}]

CALCulate:SCALE:DBM:REFerence {<référence>|MIN|MAX|DEF}

CALCulate:SCALE:DBM:REFerence? [{MIN|MAX|DEF}]

CALCulate:SCALE:FUNCTion{DB|DBM|PCT|SCALE}

CALCulate:SCALE:FUNCTion?

CALCulate:SCALE:GAIN {<gain>|MIN|MAX|DEF}

CALCulate:SCALE:GAIN? [{MIN|MAX|DEF}]

CALCulate:SCALE:OFFSet {<décalage>|MIN|MAX|DEF}

CALCulate:SCALE:OFFSet? [{MIN|MAX|DEF}]

CALCulate:SCALE:REFerence:AUTO {OFF|ON}

CALCulate:SCALE:REFerence:AUTO?

CALCulate:SCALE:REFerence {<référence>|MIN|MAX|DEF}

CALCulate:SCALE:REFerence? [{MIN|MAX|DEF}]

CALCulate:SCALE[:STATe] {OFF|ON}

CALCulate:SCALE[:STATe]?

CALCulate:SCALE:UNIT <chaîne_entre_guillemets>

CALCulate:SCALE:UNIT?

CALCulate:SCALE:UNIT:STATe {OFF|ON}

CALCulate:SCALE:UNIT:STATe?

Statistiques

CALCulate:AVERage:ALL?

CALCulate:AVERage:AVERage?

CALCulate:AVERage:CLEar[:IMMEDIATE]

CALCulate:AVERage:COUNT?

CALCulate:AVERage:MAXimum?

CALCulate:AVERage:MINimum?

CALCulate:AVERage:PTPeak?

CALCulate:AVERage:SDEVIation?

CALCulate:AVERage[:STATe] {OFF|ON}

CALCulate:AVERage[:STATe]?

Lissage

CALCulate:SMOothing:RESPonse {SLOW|MEDIUM|FAST}

CALCulate:SMOothing:RESPonse?

CALCulate:SMOothing[:STATe] {OFF|ON}

CALCulate:SMOothing[:STATe]?

Diagramme de tendance

CALCulate:TCHart[:STATe] {OFF|ON}

CALCulate:TCHart[:STATe]?

Commandes de mémoire de mesures

DATA:LAST?

DATA:POINts:EVENt:THReshold <nombre>

DATA:POINts:EVENt:THReshold?

DATA:POINts?

DATA:REMOve? <nombre_lectures> [,WAIT]

FETCH?

R? [<lectures_max>]

Commandes d'étalonnage

*CAL?

CALibration:ADC?

CALibration[:ALL]?

CALibration:COUNT?

CALibration:DATE?

CALibration:SECure:CODE <nouveau_code>

CALibration:SECure:STATE {OFF|ON} [, <code>]

CALibration:SECure:STATE?

CALibration:STORe

CALibration:STRing "<chaîne>"

CALibration:STRing?

CALibration:TEMPerature?

CALibration:TIME?

CALibration:VALue <valeur>

CALibration:VALue?

SYSTem:ACALibration:DATE?

SYSTem:ACALibration:TEMPerature?

SYSTem:ACALibration:TIME?

Commandes de stockage des états et des préférences

*LRN?

MMEMory:LOAD:PREFErences <fichier>

MMEMory:LOAD:STATE <fichier>

MMEMory:STORe:PREFErences <fichier>

MMEMory:STORe:STATE <fichier>

MMEMory:STATE:RECall:AUTO {OFF|ON}

MMEMory:STATE:RECall:AUTO?

MMEMory:STATE:RECall:SElect <fichier>

MMEMory:STATE:RECall:SElect?

MMEMory:STATE:VALid? <fichier>

*RCL {0|1|2|3|4}

*SAV {0|1|2|3|4}

Commandes de gestion de fichiers de base

MMEemory:CATalog[:ALL]? [<dossier>[<spéc_fichier>]]

MMEemory:CDIRectory <dossier>

MMEemory:CDIRectory?

MMEemory:COpy <fichier 1>, <fichier 2>

MMEemory:DElete {<fichier>|<spéc_fichier>}

MMEemory:MDIRectory <dossier>

MMEemory:MOVE <fichier 1>, <fichier 2>

MMEemory:RDIRectory <dossier>

Commandes de transfert de données

MMEemory:DOWNload:DATA <*bloc_binaire*>
MMEemory:DOWNload:FNAME <*fichier*>
MMEemory:DOWNload:FNAME?
MMEemory:FORMat:READing:CSEParator {COMMa|SEMicolon|TAB}
MMEemory:FORMat:READing:CSEParator?
MMEemory:FORMat:READing:INFormation {OFF|ON}
MMEemory:FORMat:READing:INFormation?
MMEemory:FORMat:READing:RLIMit {OFF|ON}
MMEemory:FORMat:READing:RLIMit?
MMEemory:STORe:DATA RDG_STORE, <*fichier*>
MMEemory:UPLoad? <*fichier*>

Commandes IEEE-488

*CAL?
*CLS
*ESE <*valeur_activation*>
*ESE?
*ESR?
*IDN?
*LRN?
*OPC
*OPC?
*OPT?
*PSC {0|1}
*PSC?
*RCL {0|1|2|3|4}
*RST
*SAV {0|1|2|3|4}
*SRE <*valeur_activation*>
*SRE?
*STB?
*TRG
*TST?
*WAI

Sous-système Format

FORMat:BORDER {NORMal|SWAPped}
 FORMat:BORDER?

 FORMat[:DATA] {ASCIi|REAL} [, <longueur>]
 FORMat[:DATA]?

Commandes système

*CAL?

 DISPlay[:STATe] {OFF|ON}
 DISPlay[:STATe]?

 DISPlay:TEXT:CLEar

 DISPlay:TEXT[:DATA] "<chaîne>"
 DISPlay:TEXT[:DATA]?

 DISPlay:VIEW {NUMeric|HISTogram|TCHart|METER}
 DISPlay:VIEW?

 HCOPy:SDUMp:DATA:FORMat {PNG|BMP}
 HCOPy:SDUMp:DATA:FORMat?

 HCOPy:SDUMp:DATA?

 *IDN?

 LXI:IDENtify[:STATe] {OFF|ON}
 LXI:IDENtify[:STATe]?

 LXI:MDNS:ENABle {OFF|ON}
 LXI:MDNS:ENABle?

 LXI:MDNS:HNAME[:RESolved]?

 LXI:MDNS:SNAME:DESired "<nom>"
 LXI:MDNS:SNAME:DESired?

 LXI:MDNS:SNAME[:RESolved]?

 LXI:RESet

 LXI:REStart

 *RST

 SYSTem:ACALibration:DATE?

 SYSTem:ACALibration:TEMPerature?

 SYSTem:ACALibration:TIME?

 SYSTem:BEEPer[:IMMediate]

 SYSTem:BEEPer:STATe {OFF|ON}
 SYSTem:BEEPer:STATe?

 SYSTem:CLICk:STATe {OFF|ON}
 SYSTem:CLICk:STATe?

 SYSTem:DATE <année>, <mois>, <jour>
 SYSTem:DATE?

Référence de programmation SCPI

SYSTem:ERRor[:NEXT]?
SYSTem:HELP?
SYSTem:IDENtify {DEFault|AT34460A|AT34461A|AT34410A|AT34411A|HP34401A}*
SYSTem:IDENtify?
SYSTem:LABel "<chaîne>"
SYSTem:LABel?
SYSTem:LFRequency?
SYSTem:LOCal
SYSTem:PRESet
SYSTem:SECurity:COUNT?
SYSTem:SECurity:IMMediate
SYSTem:TEMPerature?
SYSTem:TIME <heure>, <minute>, <seconde>
SYSTem:TIME?
SYSTem:UPTime?
SYSTem:USB:HOST:ENABLE {OFF|ON}
SYSTem:USB:HOST:ENABLE?
SYSTem:VERSion?
SYSTem:WMEssage "<chaîne>"
SYSTem:WMEssage?
TEST:ALL?
*TST?

**Les paramètres varient selon le numéro de modèle du multimètre numérique. Pour plus de détails, voir [SYSTem:IDENtify](#).*

Commandes de verrouillage des interfaces

SYSTem:LOCK:NAME?
SYSTem:LOCK:OWNer?
SYSTem:LOCK:RELease
SYSTem:LOCK:REQuest?

Commandes de gestion des licences

```

SYSTEM:LICense:CATalog?
SYSTEM:LICense:DElete "<nom_option>"
SYSTEM:LICense:DElete:ALL
SYSTEM:LICense:DESCription? "<nom_option>"
SYSTEM:LICense:ERRor?
SYSTEM:LICense:ERRor:COUnT?
SYSTEM:LICense:INSTall [{<dossier>|<fichier>}]
SYSTEM:LICense:INSTall? "<nom_option>"

```

Commandes de configuration des interfaces

```

SYSTEM:COMMunicate:ENable {OFF|ON}, {GPIB|HISLip|USB|LAN|SOCKets|TELNet|VXI11|WEB|USBMtp|USBHost}
SYSTEM:COMMunicate:ENABLE? {GPIB|HISLip|USB|LAN|SOCKets|TELNet|VXI11|WEB|USBMtp|USBHost}

SYSTEM:COMMunicate:GPIB:ADDRess <adresse>
SYSTEM:COMMunicate:GPIB:ADDRess?

SYSTEM:COMMunicate:LAN:CONTRol?

SYSTEM:COMMunicate:LAN:DHCP {OFF|ON}
SYSTEM:COMMunicate:LAN:DHCP?

SYSTEM:COMMunicate:LAN:DNS[{{1|2}}] "<adresse>"
SYSTEM:COMMunicate:LAN:DNS[{{1|2}}]? [{CURRENT|STATIC}]

SYSTEM:COMMunicate:LAN:DOMain?

SYSTEM:COMMunicate:LAN:GATeway "<adresse>"
SYSTEM:COMMunicate:LAN:GATeway? [{CURRENT|STATIC}]

SYSTEM:COMMunicate:LAN:HOSTname "<nom>"
SYSTEM:COMMunicate:LAN:HOSTname? [{CURRENT|STATIC}]

SYSTEM:COMMunicate:LAN:IPADdress "<adresse>"
SYSTEM:COMMunicate:LAN:IPADdress? [{CURRENT|STATIC}]

SYSTEM:COMMunicate:LAN:MAC?

SYSTEM:COMMunicate:LAN:SMASK "<masque>"
SYSTEM:COMMunicate:LAN:SMASK? [{CURRENT|STATIC}]

SYSTEM:COMMunicate:LAN:TELNet:PROMpt "<chaîne>"
SYSTEM:COMMunicate:LAN:TELNet:PROMpt?

SYSTEM:COMMunicate:LAN:TELNet:WMESsage "<chaîne>"
SYSTEM:COMMunicate:LAN:TELNet:WMESsage?

SYSTEM:COMMunicate:LAN:UPDate

SYSTEM:COMMunicate:LAN:WINS[{{1|2}}] "<adresse>"
SYSTEM:COMMunicate:LAN:WINS[{{1|2}}]? [{CURRENT|STATIC}]

SYSTEM:USB:HOST:ENABLE {OFF|ON}
SYSTEM:USB:HOST:ENABLE?

```

Commandes du système d'état

*CLS

*ESE <valeur_activation>

*ESE?

*ESR?

*PSC {0|1}

*PSC?

*SRE <valeur_activation>

*SRE?

STATus:OPERation:CONDition?

STATus:OPERation:ENABle <valeur_activation>

STATus:OPERation:ENABle?

STATus:OPERation[:EVENT]?

STATus:PRESet

STATus:QUEStionable:CONDition?

STATus:QUEStionable:ENABle <valeur_activation>

STATus:QUEStionable:ENABle?

STATus:QUEStionable[:EVENT]?

*STB?

Plage, résolution et temps d'intégration (affichés dans Ouverture et NPLC)

Les trois tableaux suivants affichent le temps d'intégration (en PLC et en secondes) pour chaque plage et résolution.

Pour déterminer le PLC d'une plage et résolution données :

1. Recherchez la plage dans la colonne de gauche. Les unités de mesure ne s'appliquent pas (par exemple, pour 1 V ou 1 A, utilisez la plage 1 ; pour 100 V ou 100 Ω, utilisez la plage 100).
2. À partir de la valeur de plage, suivez la ligne de résolutions correspondante vers la droite jusqu'à ce que la résolution spécifiée soit comprise entre deux colonnes adjacentes correspondant à votre modèle de multimètre.
3. La valeur NPLC en haut de la colonne adjacente de gauche correspond à la "configuration" NPLC de la plage et résolution données.

Par exemple, pour le modèle 34461A, une plage de 10 Vcc et une résolution de 10 μV données, recherchez la plage 10 dans le tableau. Si vous vous déplacez vers la droite, la résolution de 10 μV (1E-5) est indiquée dans la colonne située sous 10 NPLC.

Modèle	34460A					34461A				
	100	10	1	0,2	0,02	100	10	1	0,2	0,02
PLC	100	10	1	0,2	0,02	100	10	1	0,2	0,02
Ouverture (puissance de 60 Hz)	1,67 s	0,167 s	16,7 ms	3 ms	0,3 ms	1,67 s	0,167 s	16,7 ms	3 ms	0,3 ms
Ouverture (puissance de 50 Hz)	2 s	0,2 s	20 ms			2 s	0,2 s	20 ms		
FacteurRés ¹	3 ppm	10 ppm	30 ppm	100 ppm	300 ppm	0,3 ppm	1 ppm	3 ppm	10 ppm	100 ppm
Plage	Résolution									
1 m	3E-9	1E-8	3E-8	1E-7	3E-7	3E-10	1E-9	3E-9	1E-8	1E-7
10 m	3E-8	1E-7	3E-7	1E-6	3E-6	3E-9	1E-8	3E-8	1E-7	1E-6
100 m	3E-7	1E-6	3E-6	1E-5	3E-5	3E-8	1E-7	3E-7	1E-6	1E-5
1	3E-6	1E-5	3E-5	1E-4	3E-4	3E-7	1E-6	3E-6	1E-5	1E-4
10	3E-5	1E-4	3E-4	1E-3	3E-3	3E-6	1E-5	3E-5	1E-4	1E-3
100	3E-4	1E-3	3E-3	1E-2	3E-2	3E-5	1E-4	3E-4	1E-3	1E-2
1 k	3E-3	1E-2	3E-2	1E-1	3E-1	3E-4	1E-3	3E-3	1E-2	1E-1
10 k	3E-2	1E-1	3E-1	1	3	3E-3	1E-2	3E-2	1E-1	1
100 k	3E-1	1	3	10	30	3E-2	1E-1	3E-1	1	10
1 M	3	10	30	100	300	3E-1	1	3	10	100
10 M	30	100	300	1 k	3 k	3	10	30	100	1 k
100 M	300	1 k	3 k	10 k	30 k	30	100	300	1 k	10 k

¹FacteurRés x plage = Résolution.

Modèle	34465A								
PLC	100	10	1	0,2	0,06	0,02	0,006 ²	0,002 ²	0,001 ²
Ouverture (puissance de 60 Hz)	1,67 s	0,167 s	16,7 ms	3 ms	1 ms	0,3 ms	100 µs ²	40 µs ²	20 µs ²
Ouverture (puissance de 50 Hz)	2 s	0,2 s	20 ms						
Facteur Rés ¹	0,03 ppm	0,1 ppm	0,3 ppm	0,7 ppm	1,5 ppm	3 ppm	6 ppm	15 ppm	30 ppm
Plage	Résolution								
1 m	30E-12	100E-12	300E-12	700E-12	1.5E-9	3E-9	6E-9	15E-9	30E-9
10 m	300E-12	1E-9	3E-9	7E-9	1.5E-8	3E-8	6E-8	15E-8	30E-8
100 m	3E-9	1E-8	3E-8	7E-8	1.5E-7	3E-7	6E-7	15E-7	30E-7
1	3E-8	1E-7	3E-7	7E-7	1.5E-6	3E-6	6E-6	15E-6	30E-6
10	3E-7	1E-6	3E-6	7E-6	1.5E-5	3E-5	6E-5	15E-5	30E-5
100	3E-6	1E-5	3E-5	7E-5	1.5E-4	3E-4	6E-4	15E-4	30E-4
1 k	3E-5	1E-4	3E-4	7E-4	1.5E-3	3E-3	6E-3	15E-3	30E-3
10 k	3E-4	1E-3	3E-3	7E-3	1.5E-2	3E-2	6E-2	15E-2	30E-2
100 k	3E-3	1E-2	3E-2	7E-2	1.5E-1	3E-1	6E-1	15E-1	30E-1
1 M	3E-2	1E-1	3E-1	7E-1	1,5	3	6	15	30
10 M	3E-1	1	3	7	15	30	60	150	300
100 M	3	10	30	70	150	300	600	1,5 k	3 k
1 G	30	100	300	700	1,5 k	3 k	6 k	15 k	30 k

Modèle	34470A								
PLC	100	10	1	0,2	0,06	0,02	0,006 ²	0,002 ²	0,001 ²
Ouverture (puissance de 60 Hz)	1,67 s	0,167 s	16,7 ms	3 ms	1 ms	0,3 ms	100 µs ²	40 µs ²	20 µs ²
Ouverture (puissance de 50 Hz)	2 s	0,2 s	20 ms						
Facteur Rés ¹	0,01 ppm	0,03 ppm	0,1 ppm	0,3 ppm	0,5 ppm	1 ppm	3 ppm	10 ppm	30 ppm
Plage	Résolution								
1 m	10E-12	30E-12	100E-12	300E-12	500E-12	1E-9	3E-9	10E-9	30E-9
10 m	100E-12	300E-12	1E-9	3E-9	5E-9	1E-8	3E-8	10E-8	30E-8
100 m	1E-9	3E-9	1E-8	3E-8	5E-8	1E-7	3E-7	10E-7	30E-7
1	1E-8	3E-8	1E-7	3E-7	5E-7	1E-6	3E-6	10E-6	30E-6
10	1E-7	3E-7	1E-6	3E-6	5E-6	1E-5	3E-5	10E-5	30E-5
100	1E-6	3E-6	1E-5	3E-5	5E-5	1E-4	3E-4	10E-4	30E-4
1 k	1E-5	3E-5	1E-4	3E-4	5E-4	1E-3	3E-3	10E-3	30E-3
10 k	1E-4	3E-4	1E-3	3E-3	5E-3	1E-2	3E-2	10E-2	30E-2
100 k	1E-3	3E-3	1E-2	3E-2	5E-2	1E-1	3E-1	10E-1	30E-1
1 M	1E-2	3E-2	1E-1	3E-1	5E-1	1	3	10	30
10 M	1E-1	3E-1	1	3	5	10	30	100	300

Modèle	34470A								
PLC	100	10	1	0,2	0,06	0,02	0,006 ²	0,002 ²	0,001 ²
Ouverture (puissance de 60 Hz)	1,67 s	0,167 s	16,7 ms	3 ms	1 ms	0,3 ms	100 µs ²	40 µs ²	20 µs ²
Ouverture (puissance de 50 Hz)	2 s	0,2 s	20 ms						
FacteurRés ¹	0,01 ppm	0,03 ppm	0,1 ppm	0,3 ppm	0,5 ppm	1 ppm	3 ppm	10 ppm	30 ppm
Plage	Résolution								
100 M	1	3	10	30	50	100	300	1 k	3 k
1 G	10	30	100	300	500	1 k	3 k	10 k	30 k

¹FacteurRés x plage = Résolution., ² Modèles 34465A/70A équipés de l'option DIG uniquement.

Résolution et temps d'intégration pour les mesures en courant continu

Le réglage du temps d'intégration entraîne également celui de la résolution de mesure. Ce tableau décrit le rapport entre le temps d'intégration en cycles de tension d'alimentation (PLC) et la résolution.

Temps d'intégration			Résolution (34460A)	Résolution (34461A)	Résolution (34465A)	Résolution (34470A)
Cycles de tension d'alimentation	Ouverture (puissance de 60 Hz)	Ouverture (puissance de 50 Hz)				
0,001 PLC ¹	20 µs ¹		-	-	30 ppm × plage	30 ppm × plage
0,002 PLC ¹	40 µs ¹		-	-	15 ppm × plage	10 ppm × plage
0,006 PLC ¹	100 µs ¹		-	-	6 ppm × plage	3 ppm × plage
0,02 PLC (MINi-mum)	0,3 ms		300 ppm × plage (MAXi-mum)	100 ppm × plage (MAXi-mum)	3 ppm × plage	1 ppm × plage
0,06 PLC	1 ms		-	-	1,5 ppm × plage	0,5 ppm × plage
0,2 PLC	3 ms		100 ppm × plage	10 ppm × plage	0,7 ppm × plage	0,3 ppm × plage
1 PLC	16,7 ms	20 ms	30 ppm × plage	3 ppm × plage	0,3 ppm × plage	0,1 ppm × plage
10 PLC (DEFAult)	0,167 s	0,2 s	10 ppm × plage (DEFAult)	1 ppm × plage (DEFAult)	0,1 ppm × plage	0,03 ppm × plage
100 PLC (MAXi-mum)	1,67 s	2 s	3 ppm × plage (MINi-mum)	0,3 ppm × plage (MINi-mum)	0,03 ppm × plage	0,01 ppm × plage

¹Modèles 34465A/70A équipés de l'option DIG uniquement.

Retards de déclenchement automatiques

Si TRIGger:DElay:AUTO est activé, l'instrument sélectionne le retard de déclenchement à votre place, comme indiqué dans les tableaux ci-dessous.

REMARQUE Toutes les mesures de fréquence et de période ont un retard de déclenchement automatique de 1 seconde.

Les fonctions de continuité et de diode ignorent le retard de déclenchement.

Les mesures de température à 2 et 4 fils utilisent les retards de mesure de résistance en 2 et 4 fils correspondants.

Retards par défaut de la tension continue

PLC	0,001 ¹	0,002 ¹	0,006 ¹	0,02	0,06 ²	0,2	1	10	100
Ouverture (puissance de 60 Hz)	20 µs ¹	40 µs ¹	100 µs ¹	0,3 ms	1 ms ²	3 ms	16,7 ms	0,167 s	1,67 s
Ouverture (puissance de 50 Hz)							20 ms	0,2 s	2 s
Plage	Retard								
Toutes	100 µs			130 µs			160 µs		

¹ Modèles 34465A/70A équipés de l'option DIG uniquement.

² Modèles 34465A/70A uniquement.

Retards par défaut du courant continu

PLC	0,001 ¹	0,002 ¹	0,006 ¹	0,02	0,06 ²	0,2	1	10	100
Ouverture (puissance de 60 Hz)	20 µs ¹	40 µs ¹	100 µs ¹	0,3 ms	1 ms ²	3 ms	16,7 ms	0,167 s	1,67 s
Ouverture (puissance de 50 Hz)							20 ms	0,2 s	2 s
Plage	Retard								
Toutes	1 ms						1,5 ms		

¹ Modèles 34465A/70A équipés de l'option DIG uniquement.

² Modèles 34465A/70A uniquement.

Retards par défaut de la résistance (2 fils)

PLC	0,001 ¹	0,002 ¹	0,006 ¹	0,02	0,06 ²	0,2	1	10	100
Ouverture (puissance de 60 Hz)	20 µs ¹	40 µs ¹	100 µs ¹	0,3 ms	1 ms ²	3 ms	16,7 ms	0,167 s	1,67 s
Ouverture (puissance de 50 Hz)							20 ms	0,2 s	2 s
Plage	Retard								
100 Ω	80 µs			100 µs		130 µs			
1 kΩ	110 µs			130 µs		160 µs			
10 kΩ	130 µs			160 µs		190 µs			
100 kΩ	540 µs			670 µs		800 µs			
1 MΩ	5 ms			6 ms		7,5 ms			
10 MΩ	60 ms			70 ms		84 ms			
100 MΩ									
1 GΩ ²									

¹ Modèles 34465A/70A équipés de l'option DIG uniquement.

² Modèles 34465A/70A uniquement.

Retards par défaut de la résistance (4 fils)

PLC	0,001 ¹	0,002 ¹	0,006 ¹	0,02	0,06 ²	0,2	1	10	100
Ouverture (puissance de 60 Hz)	20 µs ¹	40 µs ¹	100 µs ¹	0,3 ms	1 ms ²	3 ms	16,7 ms	0,167 s	1,67 s
Ouverture (puissance de 50 Hz)							20 ms	0,2 s	2 s
Plage	Retard								
100 Ω	1 ms					1,5 ms			
1 kΩ									
10 kΩ									
100 kΩ	10 ms					15 ms			
1 MΩ									
10 MΩ	100 ms								
100 MΩ									
1 GΩ ²									

¹ Modèles 34465A/70A équipés de l'option DIG uniquement.

² Modèles 34465A/70A uniquement.

Retards par défaut de la tension alternative

Plage	Filtre (Hz)		
	3	20	200
Toutes	2,5 s	0,625 s	0,025 s

Retards par défaut du courant alternatif

	Filtre (Hz)		
Plage	3	20	200
Toutes	1,66 s	0,25 s	0,025 s

Fréquence et période

Le retard par défaut pour la fréquence et la période est de 1 s, quel que soit le paramètre d'ouverture (temps de porte).

Sortie VM Comp (Mesure terminée) (BNC)

La sortie VM Comp (Mesure terminée) du panneau arrière génère une impulsion de 3,3 V après chaque mesure pour mettre en œuvre une séquence d'établissement de liaison standard entre les dispositifs de mesure et de commutation.

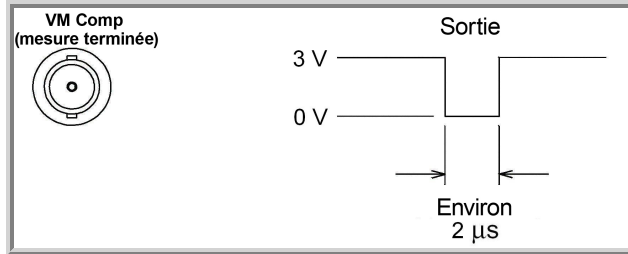

Le signal illustré se rapporte à une impulsion négative.

Messages d'erreur SCPI

Erreurs de commande (-100...)

Erreurs d'exécution (-200...)

Erreurs propres au dispositif (-300...)

Erreurs de requête (-400...)

Erreurs réseau (+100...)

Erreurs de l'instrument (+200...)

Erreurs diverses (+300... et +500..)

Erreurs de licence et d'autotest (+600...)

Erreurs d'étalonnage (+700...)

Erreurs diverses (+800...)

L'instrument renvoie des messages d'erreur conformément à la norme SCPI.

- La file d'erreurs de l'instrument peut enregistrer jusqu'à 20 erreurs. Chaque session d'E/S de l'interface de commande à distance (GPIB, USB, VXI-11, Telnet/Sockets) comporte une file d'erreurs propre à l'interface. Les erreurs sont affichées dans la file d'erreurs de la session d'E/S qui a généré l'erreur. Par exemple, si une erreur a été générée par une commande envoyée via GPIB, envoyez la commande **SYSTem:ERRor?** depuis l'interface GPIB pour lire la file des erreurs. Les erreurs générées par le matériel de l'instrument sont diffusées sur toutes les sessions d'E/S.
- L'instrument émet un signal sonore chaque fois qu'une erreur est générée (sauf si l'avertisseur sonore est désactivé par la commande **SYSTem:BEEPer:STATe OFF**). Le voyant **Error** du panneau avant s'allume lorsque la liste des erreurs contient une ou plusieurs erreurs.
- Une file d'erreurs globales spéciale contient toutes les erreurs matérielles et détectées à la mise sous tension (ex. : température excessive).
- Erreur de récupération « premier entré/premier sorti » (FIFO) ; ces erreurs sont effacées à la lecture. Après la lecture de toutes les erreurs propres à l'interface, les erreurs contenues dans la file d'erreurs globales sont récupérées. Après la lecture de toutes les erreurs présentes dans les files d'erreurs globales et propres à l'interface, le voyant **Error** s'éteint.
- Si plus de 20 erreurs se produisent, la dernière erreur enregistrée dans la file d'attente est remplacée par -350,"Queue overflow" (dépassement de la capacité de la file d'attente). Aucune erreur supplémentaire n'est enregistrée tant que vous ne supprimez pas des erreurs de la file. Si aucune erreur ne s'est produite depuis la dernière consultation de la file d'erreurs, l'instrument indique +0,"No error" (Aucune erreur).
- Le panneau avant signale les erreurs de toutes les sessions d'E/S et de la file d'erreurs globales. Pour lire la file d'erreurs à partir du panneau avant, appuyez sur **Help > View remote command error queue**.

Référence de programmation SCPI

- Les conditions d'erreur sont également récapitulées dans le registre d'octet d'état. Pour de plus amples informations sur le système d'état SCPI, reportez-vous à la section **Présentation du sous-système d'état**.
- Les files d'erreurs propres à l'interface sont effacées par la commande ***CLS** (effacement d'état) ou à la remise sous tension de l'instrument. Toutes les erreurs sont effacées à la lecture de la file d'erreurs. La file d'erreurs n'est pas effacée par une réinitialisation de la configuration d'usine (***RST**) ou un pré-réglage de l'instrument (**SYSTem:PRESet**).
- **Panneau avant :**
Si le voyant **Error** est allumé, la file d'erreurs contient des erreurs. Le voyant **Remote** est aussi probablement allumé. Appuyez sur la touche **Local** pour retourner au mode local (le voyant **Remote** s'éteint). Puis, appuyez sur **[Help]**, sélectionnez « View remote command error queue » (Afficher la file d'erreurs de commande à distance) dans le menu et appuyez sur **Select**. Consultez les messages d'erreur à l'aide des touches « fléchées » de navigation du menu. Appuyez sur **Back** pour quitter et effacer la file d'erreurs.
- **SCPI :**
SYSTem:ERRor? Read and clear one error from the queue

Les erreurs ont le format suivant (la chaîne d'erreur peut contenir jusqu'à 80 caractères).

-113, "Undefined header" (En-tête non défini)

Erreurs de commande (-100...)

- 100,"Command error"
- 101,"Invalid character"
- 102,"Syntax error"
- 103,"Invalid separator"
- 104,"Data type error"
- 105,"GET not allowed"
- 108,"Parameter not allowed"
- 109,"Missing parameter"
- 110,"Command header error"
- 111,"Header separator error"
- 112,"Program mnemonic too long"
- 113,"Undefined header"
- 114,"Header suffix out of range"
- 120,"Numeric data error"
- 121,"Invalid character in number"
- 123,"Exponent too large"
- 123,"Numeric overflow"
- 124,"Too many digits"
- 128,"Numeric data not allowed"
- 130,"Suffix error"
- 131,"Invalid suffix"
- 134,"Suffix too long"
- 138,"Suffix not allowed"
- 140,"Character data error"
- 141,"Invalid character data"
- 144,"Character data too long"
- 148,"Character data not allowed"
- 150,"String data error"
- 151,"Invalid string data"
- 158,"String data not allowed"

Référence de programmation SCPI

-160,"Block data error"

-161,"Invalid block data"

-168,"Block data not allowed"

Erreurs d'exécution (-200...)

- 203,"Command protected"
- 203,"Command protected; feature not available on this model"
- 203,"Command protected; instrument must be unsecured"
- 203,"Command protected; large memory requires license MEM"
- 203,"Command protected; License required"
- 203,"Command protected; requires license DIG"
- 203,"Command protected; requires license LAN"
- 203,"Command protected; requires license SEC"
- 203,"Secure option: Instrument security is unlocked"
- 210,"Trigger error"
- 211,"Trigger ignored"
- 213,"Init ignored"
- 214,"Trigger deadlock"
- 220,"Parameter error"
- 221,"Settings conflict"
- 221,"Settings conflict; *TRG when TRIG:SOUR BUS not selected; trigger ignored"
- 221,"Settings conflict; 10A current terminals not available with rear terminals; terminals set to 3A"
- 221,"Settings conflict; CALC not allowed in current measurement function; CALC:STAT OFF set"
- 221,"Settings conflict; CALC:SCAL:REF 0.0 not compatible with CALC:SCAL:FUNC PCT; CALC:SCAL:STATE OFF set"
- 221,"Settings conflict; cannot delete state selected and enabled for automatic power-on recall"
- 221,"Settings conflict; cannot meet requested timing; SAMP:TIM changed"
- 221,"Settings conflict; cannot meet requested timing; TRIG:DEL changed"
- 221,"Settings conflict; histogram lower range > upper range; CALC:TRAN:HIST:RANG:AUTO ON set"
- 221,"Settings conflict; histogram not allowed in current measurement function; CALC:TRAN:HIST:STAT OFF set"
- 221,"Settings conflict; internal trigger not allowed in current measurement function; TRIG:SOUR IMM selected"
- 221,"Settings conflict; limit test not allowed in current measurement function; CALC:LIM:STAT OFF set"
- 221,"Settings conflict; lower limit > upper limit; CALC:LIM:UPP set to CALC:LIM:LOW value"
- 221,"Settings conflict; offset compensation not allowed with low power ohms; low power disabled"

Référence de programmation SCPI

- 221,"Settings conflict; pretrigger count limited to 10,000 with CALC enabled; SAMP:COUN:PRET changed"
- 221,"Settings conflict; pretrigger not supported on current measurement function; SAMP:COUN:PRET 0 set"
- 221,"Settings conflict; pretrigger SAMP:COUN:PRETrig >= SAMP:COUN; SAMP:COUN:PRET changed"
- 221,"Settings conflict; SAMP:COUN limited to memory size in pretrigger mode; SAMP:COUN changed"
- 221,"Settings conflict; scaling not allowed in current measurement function; CALC:SCAL:STAT OFF set"
- 221,"Settings conflict; smoothing not allowed in current measurement function; CALC:SMO:STAT OFF set"
- 221,"Settings conflict; statistics not allowed in current measurement function; CALC:AVER:STAT OFF set"
- 221,"Settings conflict; TRIG:LEVel value < minimum for current measurement function/range; TRIG:LEV MIN selected"
- 221,"Settings conflict; TRIG:LEVel value > maximum for current measurement function/range; TRIG:LEV MAX selected"
- 221,"Settings conflict; trigger count must be 1 in pretrigger mode; TRIG:COUN 1 set"
- 221,"Settings conflict; trigger source is BUS"
- 222,"Data out of range"
- 222,"Data out of range; value clipped to lower limit"
- 222,"Data out of range; value clipped to upper limit"
- 222,"Data out of range; value requires license DIG"
- 222,"Data out of range; value requires license MEM"
- 223,"Too much data"
- 224,"Illegal parameter value"
- 225,"Out of memory; measurement data overrun"
- 230,"Data corrupt or stale"
- 231,"Data questionable; requested sample timing not met"
- 240,"Hardware error; cannot communicate with measurement hardware"
- 240,"Hardware error; CPU board initialization failed"
- 240,"Hardware error; GPIB interface failed"
- 240,"Hardware error; measurement FPGA FIFO overflow"
- 240,"Hardware error; measurement hardware initialization failed"
- 241,"Hardware missing"
- 250,"Mass storage error: file read/write error"

- 250,"Mass storage error; internal file system could not be opened"
- 250,"Mass storage error; USB file system could not be opened"
- 253,"Corrupt media; file system corruption detected; reformat needed"
- 253,"Corrupt media; internal file system format failed"
- 253,"Corrupt media; internal file system scan failed"
- 253,"Corrupt media; USB file system scan failed"
- 256,"File name not found"
- 256,"File or folder name not found"
- 257,"File name error"
- 257,"File name error; access denied"
- 257,"File name error; drive name missing or not recognized"
- 257,"File name error; file or folder already exists"
- 257,"File name error; file too large"
- 257,"File name error; folder is default folder"
- 257,"File name error; folder not empty"
- 257,"File name error; invalid character in name"
- 257,"File name error; not a folder name"
- 257,"File name error; path is a folder name"
- 257,"File name error; path name missing"
- 257,"File name error; path too long"
- 257,"File name error; relative path not allowed"
- 257,"File name error; unknown file extension"
- 292,"Referenced name does not exist"

Référence de programmation SCPI

Erreurs propres au dispositif (-300...)

- 310,"System error"
- 310,"System error: secondary processor aborted due to error"
- 310,"System error; internal software error"
- 310,"System error; out of memory"
- 310,"System error; software initialization failed"
- 313,"Calibration memory lost"
- 313,"Calibration memory lost; due to firmware revision change"
- 314,"Save/recall memory lost; due to firmware revision change"
- 314,"Save/recall memory lost; memory corruption detected"
- 315,"Configuration memory lost"
- 315,"Configuration memory lost; due to firmware revision change"
- 315,"Configuration memory lost; memory corruption detected"
- 350,"Queue overflow"

Erreurs de requête (-400...)

- 400,"Query error"
- 410,"Query INTERRUPTED"
- 420,"Query UNTERMINATED"
- 430,"Query DEADLOCKED"
- 440,"Query UNTERMINATED after indefinite response"

Erreurs réseau (+100...)

- +100,"Network Error"
- +110,"LXI mDNS Error"

Erreurs de l'instrument (+200...)

- +251, "Unsupported temperature transducer type"
- +263, "Not able to execute while instrument is measuring"
- +292, "State file size error"
- +293, "State file corrupt"
- +294, "Preference file size error"
- +295, "Preference file corrupt"

Erreurs diverses (+300... et +500..)

- +311, "Not able to specify resolution with Auto range"
- +320, "Secondary processor communications error: boot message queue overflowed"
- +320, "Secondary processor communications error: command returned error status"
- +320, "Secondary processor communications error: communications restart failed"
- +320, "Secondary processor communications error: communications restart succeeded"
- +320, "Secondary processor communications error: data packet error detected"
- +320, "Secondary processor communications error: read error detected"
- +320, "Secondary processor communications error: write error detected"
- +514, "Not allowed; Instrument locked by another I/O session"
- +532, "Not able to achieve requested resolution"
- +540, "Cannot use overload as math reference"
- +541, "Cannot use zero as math reference for PCT scaling function"
- +542, "Measured dB reference too small"

Référence de programmation SCPI

Erreurs de licence et d'autotest (+600...)

- +600, "Internal licensing error"
- +601, "License file corrupt or empty"
- +602, "No valid licenses found for this instrument"
- +603, "Some licenses could not be installed"
- +604, "License not found"
- +605, "License already installed"
- +611, "Self-test failed; Real Time Clock reset, check battery"
- +612, "Self-test failed; keyboard processor not responding"
- +613, "Self-test failed; unable to communicate with power controller"
- +614, "Self-test failed; unable to sense line frequency"
- +615, "Self-test failed; measurement processor not responding"
- +616, "Self-test failed; calibration memory reading error"
- +617, "Self-test failed; FPGA unconfigured"
- +618, "Self-test failed; FPGA bus error"
- +619, "Self-test failed; FPGA clock"
- +620, "Self-test failed; shift register"
- +621, "Self-test failed; overload sense stuck on"
- +622, "Self-test failed; ADC generic error"
- +623, "Self-test failed; ADC integrator saturated"
- +624, "Self-test failed; Coarse ADC error"
- +625, "Self-test failed; ADC offset"
- +626, "Self-test failed; ADC noise"
- +627, "Self-test failed; Fine ADC generic error"
- +628, "Self-test failed; Fine ADC off-scale low"
- +629, "Self-test failed; Fine ADC off-scale high"
- +630, "Self-test failed; Fine ADC range"
- +631, "Self-test failed; Fine ADC bits stuck"
- +632, "Self-test failed; Fine ADC slope"
- +633, "Self-test failed; Fine ADC linearity"
- +634, "Self-test failed; low DC zero"

+635,"Self-test failed; high DC zero"
+636,"Self-test failed; +7V reference"
+637,"Self-test failed; -10V reference"
+638,"Self-test failed; x1 gain, zero input"
+639,"Self-test failed; x10 gain, zero input"
+640,"Self-test failed; x100 gain, zero input"
+641,"Self-test failed; precharge"
+642,"Self-test failed; x1 gain, non-zero input"
+643,"Self-test failed; x10 gain, non-zero input"
+644,"Self-test failed; x100 gain, non-zero input"
+645,"Self-test failed; 100uA current source"
+646,"Self-test failed; 10uA current source"
+647,"Self-test failed; 2 ohm shunt"
+648,"Self-test failed; AC offset"
+649,"Self-test failed; frequency input"
+650,"Self-test failed; input switch"
+651,"Self-test failed; autocal 10 V range full scale"
+652,"Self-test failed; autocal 10 V range tenth scale"
+653,"Self-test failed; autocal 1 V range full scale"
+654,"Self-test failed; autocal 1 V range tenth scale"
+655,"Self-test failed; autocal 100 mV range full scale"
+656,"Self-test failed; autocal 100 V range reference"
+657,"Self-test failed; autocal 10 kOhm range full scale"
+658,"Self-test failed; autocal 10 kOhm range tenth scale"
+659,"Self-test failed; autocal 1 kOhm range full scale"
+660,"Self-test failed; autocal 100 kOhm tenth scale"
+661,"Self-test failed; autocal 1 MOhm half scale"
+662,"Self-test failed; autocal 100 KOhm to 1 MOhm transfer"
+663,"Self-test failed; autocal 1 MOhm to 10 MOhm transfer"
+664,"Self-test failed; autocal 10 MOhm internal resistor"
+665,"Self-test aborted; high ac voltage present on input terminals"
+666,"Self-test aborted; high dc voltage present on input terminals"

Erreurs d'étalonnage (+700...)

- +701, "Calibration error; security defeated"
- +702, "Calibration error; calibration memory is secured"
- +703, "Calibration error; secure code provided was invalid"
- +704, "Calibration error: secure code too long"
- +705, "Calibration error; calibration aborted"
- +706, "Calibration error: provided value out of range"
- +707, "Calibration error: computed correction factor out of range"
- +708, "Calibration error: signal measurement out of range"
- +708, "Calibration error; signal frequency out of range"
- +709, "Calibration error: no calibration for this function/range"
- +710, "Calibration error: full scale correction out of range"
- +711, "Calibration error: calibration string too long"
- +712, "Calibration failed"
- +713, "Calibration error; ADC calibration failed; ADC configuration 'ACI' did not converge"
- +713, "Calibration error; ADC calibration failed; ADC configuration 'ACV' did not converge"
- +713, "Calibration error; ADC calibration failed; ADC configuration 'DCV' did not converge"
- +713, "Calibration error; ADC calibration failed; DC offset for setup 'ACI'"
- +713, "Calibration error; ADC calibration failed; DC offset for setup 'ACV'"
- +713, "Calibration error; ADC calibration failed; DC offset for setup 'DCV'"
- +713, "Calibration error; ADC calibration failed; feedbackLutGainTune unsupported LUT goal"
- +713, "Calibration error; ADC calibration failed; feedbackLutTune search did not converge"
- +713, "Calibration error; ADC calibration failed; feedbackPiCancel did not converge for setup 'ACI'"
- +713, "Calibration error; ADC calibration failed; feedbackPiCancel did not converge for setup 'ACV'"
- +713, "Calibration error; ADC calibration failed; feedbackPiCancel did not converge for setup 'DCV'"
- +713, "Calibration error; ADC calibration failed; fine merge for setup 'ACI'"
- +713, "Calibration error; ADC calibration failed; fine merge for setup 'ACV'"
- +713, "Calibration error; ADC calibration failed; fine merge for setup 'DCV'"
- +713, "Calibration error; ADC calibration failed; fine offset for setup 'ACI'"
- +713, "Calibration error; ADC calibration failed; fine offset for setup 'ACV'"
- +713, "Calibration error; ADC calibration failed; fine offset for setup 'DCV'"

- +713,"Calibration error; ADC calibration failed; fineDcCancel found non-monotonic value in setup 'ACI'"
- +713,"Calibration error; ADC calibration failed; fineDcCancel found non-monotonic value in setup 'ACV'"
- +713,"Calibration error; ADC calibration failed; fineDcCancel found non-monotonic value in setup 'DCV'"
- +713,"Calibration error; ADC calibration failed; LUT gain for setup 'ACI'"
- +713,"Calibration error; ADC calibration failed; LUT gain for setup 'ACV'"
- +713,"Calibration error; ADC calibration failed; LUT gain for setup 'DCV'"
- +713,"Calibration error; ADC calibration failed; LUT goal incompatible with ACV"
- +713,"Calibration error; ADC calibration failed; PI offset for setup 'ACI'"
- +713,"Calibration error; ADC calibration failed; PI offset for setup 'ACV'"
- +713,"Calibration error; ADC calibration failed; PI offset for setup 'DCV'"
- +713,"Calibration error; DCV 10M input impedance gain adjustment out of range"
- +715,"Calibration error; must perform +100mV DCV calibration before -100mV"
- +715,"Calibration error; must perform +100uA DCI calibration before -100uA"
- +715,"Calibration error; must perform +10V DCV calibration before -10V"
- +715,"Calibration error; must perform 10MOhm calibration before 100MOhm"
- +720,"Calibration error; DCV offset out of range"
- +721,"Calibration error; DCI offset out of range"
- +722,"Calibration error; RES offset out of range"
- +723,"Calibration error; FRES offset out of range"
- +724,"Calibration error; extended resistance self cal failed"
- +725,"Calibration error; 1000V DC correction out of range"
- +726,"Calibration error; ACV offset out of range"
- +727,"Calibration error; ACI offset out of range"
- +730,"Calibration error; precharge DAC convergence failed"
- +731,"Calibration error; A/D turnover correction out of range"
- +732,"Calibration error; AC flatness calibration failed"
- +733,"Calibration error; AC low frequency correction out of range"
- +734,"Calibration error; AC flatness calibration restarted by function/range change"
- +735,"Calibration error; 1 kHz AC flatness frequency point must be last frequency point in sequence"
- +736,"Calibration error; DCI 100uA range self-cal failed"
- +740,"Calibration data lost: secure state"
- +740,"Calibration information lost; count, security state, security code, string"

Référence de programmation SCPI

- +741, "Calibration data lost: string data"
- +742, "Calibration data lost: corrections"
- +746, "System information write failure"
- +747, "System information read failure"
- +748, "Calibration memory write failure"
- +749, "Calibration memory read failure"
- +750, "Autocalibration corrections lost; due to firmware revision change"
- +750, "Autocalibration corrections lost"
- +751, "Autocalibration memory write failure"
- +752, "Autocalibration memory read failure"
- +753, "Autocalibration measurement out of range"
- +760, "Operation aborted; high voltage present on input terminals"

Erreurs diverses (+800...)

- +800, "Nonvolatile memory write failure"
- +810, "State has not been stored"
- +820, "Model and serial numbers not restored"
- +821, "Controller and measurement board model numbers do not match"
- +822, "Controller and measurement board serial numbers do not match"
- +823, "Incorrect firmware loaded for this model number"

État à la mise sous tension/réinitialisation

Les tableaux suivants indiquent les réglages configurés par défaut en usine. Les paramètres signalés par une puce (·) ne sont pas volatiles ; ils ne sont pas affectés par la mise sous tension ou la réinitialisation du système. Les autres paramètres sont volatiles et réinitialisés avec les valeurs indiquées à la mise sous tension ou après l'exécution de la commande ***RST** ou **SYSTem:PRESet**.

REMARQUE La configuration à la mise sous tension ou après une réinitialisation peut différer de ces valeurs si vous avez activé le mode de rappel de la configuration à la mise sous tension.

Réglages usine par défaut

Configuration de mesure	Réglage d'usine
Fonction	Tension continue
Plage	Commutation automatique de plage (pour toutes les fonctions)
Temps d'intégration	NPLC activé, 10 cycles de tension d'alimentation (PLC)*
Résolution	Résolution équivalente à 10 PLC
Réglage automatique du zéro	Activé*
Ouverture (modèles 34465A/70A uniquement)*	Désactivée, 100 ms
Ouverture de fréquence ou de période (temps de porte)	100 ms*
· Impédance d'entrée	· 10 M Ω (fixe pour toutes les plages de tension continue)
Filtre d'entrée secteur (bande passante)	20 Hz (filtre moyen)
Type de capteur de température	FRTD
Résistance de référence de RTD	100 Ω
Valeurs de référence (fonctions individuelles)	Désactivées ; référence = 0,0 avec référence automatique activée (pour toutes les fonctions de mesure)
Bornes de courant	3 A
Mesures secondaires	Désactivées
Format de capture d'écran	PNG
Valeur d'étalonnage	0,0
Mode de commutation de courant (modèles 34465A/70A uniquement)	Continu
Résistance (2 et 4 fils) (modèles 34465A/70A uniquement) :	
Compensation de décalage	Désactivées
Mesures de basse puissance	Désactivées
Température (modèles 34465A/70A uniquement) :	
Compensation de décalage (RTD 2 et 4 fils)	Désactivée
Mesures de basse puissance (RTD ou thermistance 2 et 4 fils)	Désactivées
Thermocouple (modèles 34465A/70A uniquement) :	
Vérification	Désactivée
Température de jonction de référence, type, réglage	0° C, Interne, 0° C

Référence de programmation SCPI

Configuration de mesure	Réglage d'usine
Type de thermocouple	J
* Pour toutes les fonctions de mesure en courant continu.	

Opérations mathématiques	Réglage d'usine
Configuration mathématique	Désactivée
Fonction d'échelle	Null (Valeur de référence)
Valeur de référence et relative dB	Définie à 0,0 avec référence automatique activée
Limites supérieure et inférieure	0,0
Histogramme	Nombre de cases effacées ; 100 cases ; fonction Auto binning (binning automatique) activée
Statistiques	Effacées
- Résistance de référence dBm	- 600 Ω
Calculer l'échelle (modèles 34465A/70A uniquement) :	
Gain	1,0
Décalage	0,0
Référence	0,0
État de l'appareil	Désactivé
Unité	Chaîne vide
Calculer le lissage (modèles 34465A/70A uniquement) :	
Réponse	Rapide
État	Désactivé

Opérations de déclenchement	Réglage d'usine
Nombre de déclenchements	1
Source de déclenchement	Immédiate
Retard de déclenchement	Retard automatique
Nombre d'échantillons	1
Pente de déclenchement	Négatif
Pente de sortie VM Comp	NEG
Nombre de pré-déclenchements (modèles 34465A/70A uniquement)	0
Déclenchement (modèles 34465A/70A uniquement) :	
Source d'échantillonnage	Immédiate
Temporisateur d'échantillonnage	1 s
Niveau de déclenchement	0,0

Opérations système	Réglage d'usine
• Mode avertisseur sonore	• On (Activé)
• Séparateur de milliers	• On (Activé)
État d'affichage	Activé
Mémoire de mesures	Effacées
File d'erreurs	Voir la remarque
• Configurations enregistrées	• Inchangées
• État d'étalonnage	• Sécurité verrouillée

Paramètres de données	Réglage d'usine
Format de bloc de données binaires (modèles 34465A/70A uniquement) :	
Bordure	Normale
Données	ASCII, 9
Transfert de données (modèles 34465A/70A uniquement) :	
Séparateur	Virgule
En-tête	Désactivé
Limites de mesure	Désactivées

REMARQUE La File d'erreurs est effacée à la mise sous tension. Elle n'est pas effacée par la commande ***RST** ou **SYSTem:PRESet**, ou un pré-réglage du panneau avant.

Configuration des entrées/sorties	Réglage d'usine
Activer les interfaces :¹	
• LAN	• Activé
• GPIB	• Activé
• USB	• Activé
Paramètres LAN :²	
• DHCP	• On (Activé)
• Adresse Auto-IP	• On (Activé)
• Adresse IP	• 169.254.4.61
• Masque de sous-réseau	• 255.255.0.0
• Passerelle par défaut	• 0.0.0.0
• Serveur DNS	• 0.0.0.0
• Nom d'hôte	• K-34460A- <i>nnnnn</i> (pour le modèle 34460A) ³ • K-34461A- <i>nnnnn</i> (pour le modèle 34461A) • K-34465A- (pour le modèle 34465A) <i>nnnnn</i> • K-34470A- (pour le modèle 34470A) <i>nnnnn</i>
• Services LAN ¹	Activer tout (Réseau local VISA, sockets, Telnet, serveur Web, mDNS, HiSLIP)

Référence de programmation SCPI

Configuration des entrées/sorties	Réglage d'usine
Paramètres GPIB :	
- Adresse GPIB	- 22
1 L'activation de l'interface ou les modifications des services LAN ne sont prises en compte qu'après une remise sous tension. 2 Pour que les modifications des paramètres LAN soient prises en compte, vous devez redémarrer le réseau local. Vous devez remettre l'instrument sous tension à partir de SCPI. 3 Où <i>nnnnn</i> correspond aux 5 derniers chiffres du numéro de série de l'instrument.	

REMARQUE

L'instrument utilise le port 5024 du réseau local pour les sessions Telnet SCPI et le port 5025 pour les sessions sur socket SCPI.

Entretien et réparation

Cette section contient des informations de base sur l'entretien de l'instrument.

[Types d'interventions et de contrats de maintenance possibles](#)

[Nettoyage](#)

[Précautions contre les décharges électrostatiques \(ESD\)](#)

Autres informations sur la maintenance et l'entretien :

[Blocs d'alimentation](#)

[Dépannage](#)

[Procédures d'autotest](#)

[Pièces remplaçables par l'utilisateur](#)

[Démontage](#)

[Remplacement de la batterie](#)

[Remplacement des fusibles d'entrée de courant 3 A et 10 A](#)

[Installation de l'interface GPIB en option](#)

Types d'interventions et de contrats de maintenance possibles

Si votre instrument tombe en panne pendant la période de garantie, Keysight Technologies s'engage à le réparer ou le remplacer selon les conditions de votre garantie. Après l'expiration de la garantie, Keysight propose des services de réparation économiques. Vous avez également la possibilité de souscrire un contrat de maintenance qui prolonge la période de couverture une fois la garantie standard expirée.

Trouver un service de réparation (international)

Pour faire réparer votre instrument, [contactez votre Centre de maintenance Keysight Technologies le plus proche](#) qui organisera la maintenance ou le remplacement, et vous fournira des informations sur la garantie ou le coût des réparations selon le cas. Demandez au Centre de maintenance Keysight Technologies les consignes d'expédition, y compris les composants à envoyer. Nous recommandons de conserver le carton d'emballage pour les expéditions de retour.

Remballage pour l'expédition

Pour expédier l'instrument à des fins de maintenance ou de réparation, procédez comme suit :

- Apposez sur l'instrument une étiquette d'identification du propriétaire et indiquant l'intervention nécessaire (maintenance ou réparation). Incluez les numéros de modèle et de série complets de l'instrument.
- Placez l'instrument dans son emballage d'origine avec des matériaux d'emballage adéquats.
- Protégez le colis avec des bandes adhésives ou métalliques résistantes.
- Si l'emballage d'origine n'est pas disponible, utilisez un emballage qui laisse un espace d'au moins 10 cm pour le matériau d'emballage compressible autour de l'ensemble de l'instrument. Utilisez des matériaux d'emballage antistatiques.
- Retirer le module d'interface GPIB de l'appareil si celui-ci en possède un et si le module ne présente pas de panne.

Keysight recommande d'assurer systématiquement vos expéditions.

Nettoyage

Pour prévenir les risques d'électrocution, débranchez l'instrument de l'alimentation secteur et tous les cordons de test avant les opérations de nettoyage. Nettoyez la partie extérieure de l'instrument avec un chiffon doux non pelucheux légèrement humidifié.

N'utilisez pas de lessive ou de solvant.

Ne tentez aucune opération de nettoyage interne.

Si nécessaire, contactez un bureau de ventes et de service après-vente Keysight Technologies pour convenir de travaux d'entretien adéquats afin de garantir la préservation des fonctions de sécurité et des performances.

Précautions contre les décharges électrostatiques (ESD)

Pendant les manipulations, des décharges électrostatiques inférieures à 50 V peuvent endommager la plupart des composants électriques.



Les recommandations suivantes permettent d'éviter les dommages dus aux décharges électrostatiques (ESD) pendant les interventions de maintenance :

- Démontez les instruments uniquement dans une zone antistatique.
- Utilisez un plan de travail conducteur pour réduire les décharges.
- Utilisez un bracelet antistatique pour réduire les décharges.
- Manipulez l'instrument au minimum.
- Conservez les pièces détachées dans un emballage d'origine antistatique.
- Enlevez de l'environnement immédiat du poste de travail les matières plastiques, la mousse, le vinyle, le papier et les autres matériaux à fort potentiel électrostatique.

Côté composant de la carte

Pour les mesures suivantes, l'instrument doit être sous tension et le témoin situé sous l'interrupteur d'alimentation doit s'allumer en vert.

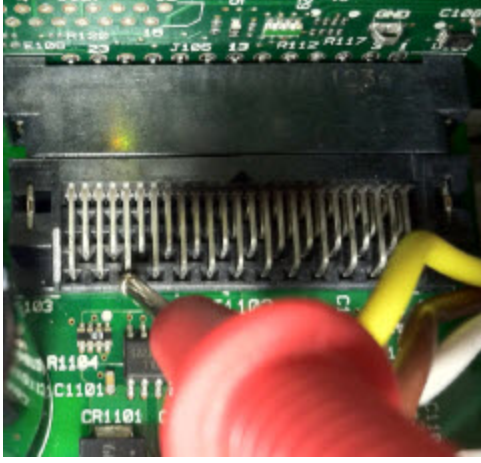
Pour obtenir des informations sur l'emplacement exact, reportez-vous aux images détaillées du tableau.

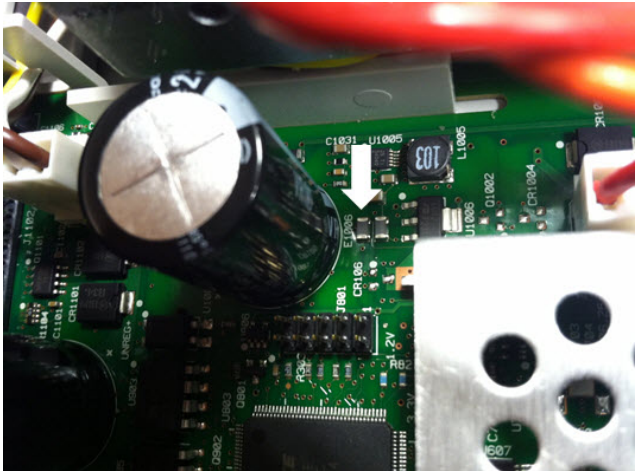
Broche	Détail de l'emplacement
Référence basse tension : châssis J1102 broche 21 : $3,3\text{ V} \pm 5\%$	
Référence basse tension : grande enveloppe métallique R1020 (de chaque côté du composant) : $10\text{ V} \pm 20\%$	
Référence basse tension : grande enveloppe métallique E1006 (de chaque côté du composant) : $3,3\text{ V} \pm 5\%$	

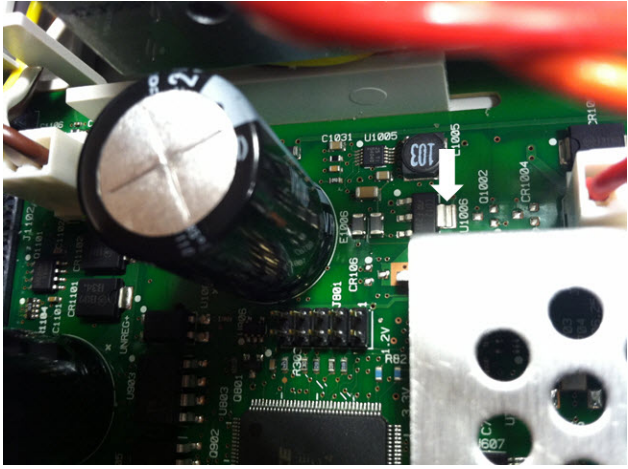
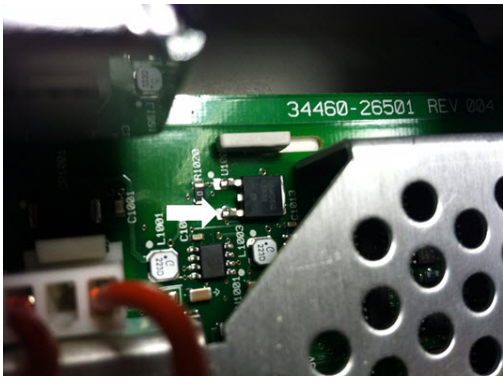
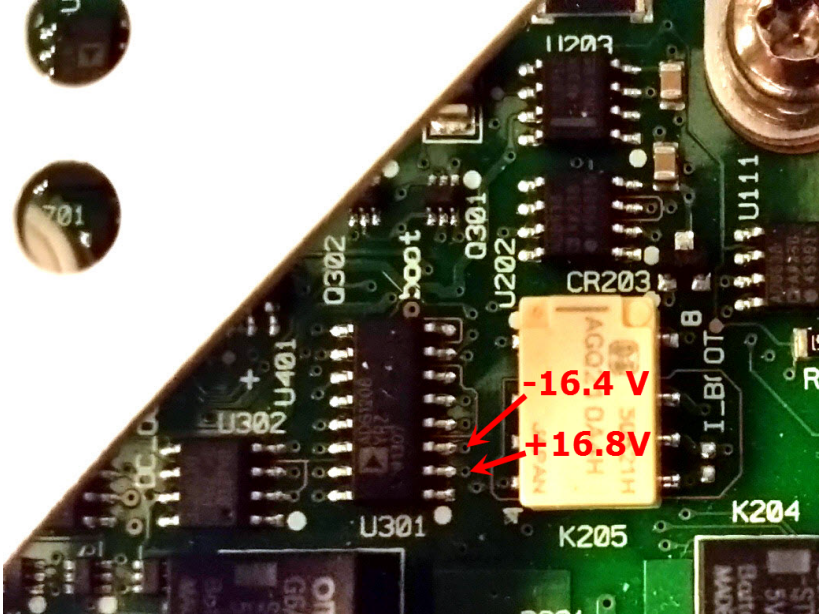
Broche	Détail de l'emplacement
<p>Référence basse tension : grande enveloppe métallique</p> <p>U1006 (grande patte située sur le côté droit comme indiqué dans l'image) :</p> <p>1,2 V \pm 5 %</p>	
<p>Référence basse tension : grande enveloppe métallique</p> <p>Broche 3 U1004 :</p> <p>5 V \pm 5 %</p>	
<p>Référence basse tension : grande enveloppe métallique</p> <p>U301 :</p> <p>broche 2 : +16,8 V \pm 5 %</p> <p>broche 3 : -16,4 V \pm 5 %</p>	

Dépannage

Avant de dépanner ou de réparer l'instrument, vérifiez que la panne provient de l'instrument et non de connexions externes. Vérifiez également que l'instrument a été étalonné avec précision au cours de l'année précédente (voir la section **Intervalle d'étalonnage**). Les circuits de l'instrument permettent le dépannage et les réparations avec un matériel de test courant.

MISE EN GARDE

NE REMPLACEZ PAS la carte mère ou la carte du panneau avant par des composants d'un autre instrument. Ces cartes contiennent le numéro du modèle et le numéro de série qui identifient sans équivoque un instrument donné ; des cartes ne correspondant pas à l'instrument peuvent poser des problèmes de fonctionnement, de licence, de maintenance, d'importation/exportation ou de garantie.

Procédure de dépannage

1. Retirez toutes les connexions d'E/S distantes et connexions du panneau avant de l'instrument. Vérifiez que :
 - a. le cordon d'alimentation secteur est solidement fixé à l'instrument et branché dans une prise secteur sous tension
 - b. l'interrupteur d'alimentation Power On/Standby du panneau avant est enfoncé
2. Si le témoin de veille situé sous l'interrupteur d'alimentation n'est pas allumé, vérifiez à nouveau les composants ci-dessus. Si tout fonctionne correctement, vérifiez l'alimentation secteur, puis le fusible d'alimentation interne.
3. Si le témoin de veille est allumé (jaune ou vert), appuyez sur l'interrupteur d'alimentation principal. En l'absence de réponse, remplacez la carte du panneau avant car l'interrupteur d'alimentation principal du panneau avant est probablement défectueux.
4. **Vérifiez les tensions présentes sur le module d'alimentation.** Si un ou plusieurs de ces tests échouent, débranchez les connecteurs secondaires du transformateur de la carte principale et mesurez les tensions du transformateur à l'aide d'un voltmètre en courant alternatif.

La tension mesurée entre les fils rouge et orange (ci-dessous) doit être comprise entre 7,5 et 11 Vca.

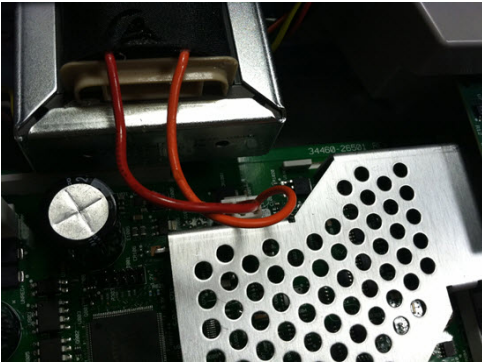

La tension mesurée entre les fils marron et blanc (ci-dessous) doit être comprise entre 11 et 15 Vca.

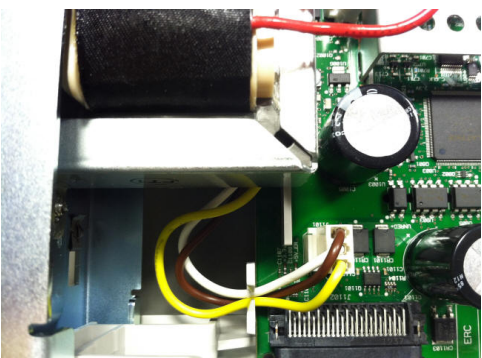

5. Si les tensions sont correctes, remplacez la carte principale. Sinon, remplacez le transformateur.

6. Mettez l'instrument sous tension. Si la séquence de mise sous tension se termine et que l'écran semble fonctionner correctement, vérifiez que l'instrument est en mode local (le voyant Remote situé dans l'angle supérieur droit de l'écran n'est pas allumé), et effectuez l'autotest complet ([Utility] > Test/Admin > Self-Test > Full Test). Si l'écran est illisible, remplacez la carte du panneau avant.

MISE EN GARDE

Vérifiez que toutes les connexions (avant et arrière) sont retirées pendant l'exécution de l'autotest. Pendant l'autotest, des erreurs peuvent se produire en raison de signaux présents sur les câbles externes (ex. cordons de test longs qui provoquent un effet d'antenne).

7. Si l'autotest génère une erreur, enregistrez le code et le message d'erreur, puis contactez l'équipe Keysight, si nécessaire.
8. Si l'autotest ne génère pas d'erreurs :
 - a. Si la fonctionnalité des E/S distantes sur GPIB (en option) ne répond pas, remplacez la carte GPIB.
 - b. Si les mesures ne sont pas conformes aux spécifications, il est préférable d'étalonner l'instrument avant de décider de remplacer ou non la carte principale.
 - c. Si les touches du panneau avant ne fonctionnent pas, assurez-vous que l'instrument est en mode local (le voyant Remote situé dans l'angle supérieur droit de l'écran est éteint). Si le problème persiste, remplacez la carte du panneau avant.
 - d. Si l'affichage est trop sombre, **réglez l'intensité de l'écran**.
9. Si l'instrument ne termine pas la séquence de mise sous tension, vérifiez la fréquence du signal au point de test TP200 sur la carte du panneau avant qui doit être de 29,8 kHz \pm 500 Hz. Si la fréquence est incorrecte, remplacez la carte du panneau avant.



Entretien et réparation

10. Vérifiez également que la tension est égale à $3,3\text{ V} \pm 5\%$ sur la résistance R121, indiquée sur le châssis de l'instrument. Si cette tension est incorrecte, remplacez la carte du panneau avant.

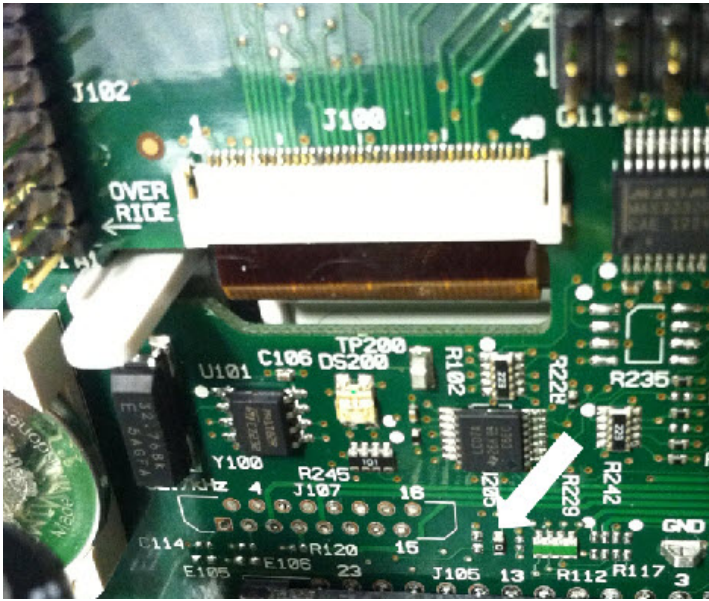

Procédures d'autotest

Autotest à la mise sous tension

Chaque fois que l'instrument est mis sous tension, il effectue un autotest sur l'horloge en temps réel, le processeur de clavier, le contrôleur d'alimentation, le processeur de mesure, la mémoire d'étalonnage, le réseau de portes programmables par l'utilisateur, le convertisseur A/N, le circuit de gain et de décalage et les références de tension. Cet autotest est équivalent à la requête SCPI *TST? et il n'est pas nécessaire de supprimer des entrées de l'instrument pour effectuer le test.

Autotest complet

Un autotest complet (**TEST:ALL?**) prend environ deux secondes. Ce test évalue l'ensemble des composants testés par l'autotest à la mise sous tension et inclut d'autres tests pour le gain, la source de courant et le circuit de shunt.

Une fois l'autotest terminé, le message « Self-test Passed » (Autotest réussi) ou « Self-test Failed » (Échec de l'autotest) s'affiche sur le panneau avant.

Effectuez l'autotest complet avant toute procédure de vérification ou d'étalonnage.

MISE EN GARDE Vous devez supprimer toutes les connexions d'entrée à l'instrument avant d'effectuer l'autotest complet.

Depuis l'interface de commande à distance

1. Connectez l'instrument via l'interface de commande à distance (**Configuration de l'interface de commande à distance**).
2. Envoyez la commande ***TST?** ou **TEST:ALL?** et lisez le résultat : réussite (+0) ou échec (+1). Utilisez la commande **SYSTem:ERRor?** pour visualiser les erreurs. Pour plus de détails, reportez-vous à la **liste des erreurs d'autotest**.

Depuis le panneau avant

1. Appuyez sur **[Shift]** > **[Utility]** > **Test/Admin** > **Self Test**.
2. Pour visualiser d'éventuelles erreurs, appuyez sur **[Shift]** > **[Help]** > **View remote command error queue**.

Pièces remplaçables par l'utilisateur

Les pièces de rechange de l'instrument sont répertoriées ci-dessous. Sauf indication contraire, l'ensemble des pièces concernent tous les modèles Truevolt.

Référence	Description
34401-86020	Kit antichocs
33220-88304	Cadre arrière
34401-45021	Poignée
33220-84101	Capot
5041-5228	Clavier
2090-1051	Écran
2110-0817	Fusible secteur (250 mA, 250 V, délai)
2110-1547	Fusible de protection de courant (3,15 A, 500 VAC/ 400 VDC, délai)
2110-1402	Fusible interne (11 A, 1 000 V, à réaction rapide)
34460-87910	Transformateur
34401-45012	Loquet de borne
5041-5238	Module d'alimentation
34460-40201	Panneau avant en plastique (34460A)
34461-40201	Panneau avant en plastique (34461A)
34465-40201	Panneau avant en plastique (34465A)
34470-40201	Panneau avant en plastique (34470A)
53200-49311	Fenêtre
5041-5231	Couvercle de panneau avant
5041-5225	Tige de culbuteur avant/arrière (34461A, 34465A, 34470A)
5041-5232	Ventilateur (34461A, 34465A, 34470A)
5041-5261	Défecteur de ventilateur (34461A, 34465A, 34470A)
5041-5257	Ensemble câble, thermistance (34465A, 34470A)
1420-0356	Batterie (du panneau avant)
34470-66303	Ensemble de référence

Démontage

Cette section décrit la procédure de démontage de l'instrument.

AVERTISSEMENT

Seules des personnes qualifiées, formées à la maintenance et conscientes des risques d'électrocution encourus peuvent démonter les capots de l'instrument. Débranchez toujours le cordon d'alimentation et tous les circuits externes avant de démonter le capot de l'instrument. Certains circuits sont actifs et sont donc encore alimentés même lorsque l'interrupteur d'alimentation est en position d'arrêt.

Débranchez systématiquement l'ensemble des entrées, des cordons et des câbles avant de démonter l'instrument.

MISE EN GARDE

Ne tournez pas la vis qui maintient le couvercle en place, sous peine de compromettre l'étalonnage de l'instrument.



Outils nécessaires

Les outils suivants sont nécessaires.

- Tournevis Torx T20 (essentiellement pour le démontage)
- Petit tournevis à tête plate (pour l'extraction)

Procédure générale de démontage

1. Mettez l'instrument hors tension et débranchez tous les cordons de mesure et autres câbles, notamment le cordon d'alimentation, avant de poursuivre.
2. Tournez la poignée en position verticale et retirez-la en la tirant vers l'extérieur à l'emplacement de fixation au boîtier.



3. Tirez sur le plot en caoutchouc avant pour l'extraire.
4. Desserrez les deux vis imperdables du cadran arrière et retirez ce dernier ainsi que le plot en caoutchouc.



5. Retirez la vis située au bas de l'instrument et placez-la à un emplacement sûr en vue de sa repose ultérieure. Faites glisser le capot de l'instrument.



REMARQUE À ce stade, l'instrument est suffisamment démonté pour vous permettre d'effectuer les tâches de dépannage de l'alimentation électrique. Vous pouvez également remplacer la batterie ou **remplacer le code de sécurité** à ce stade. Pour démonter le panneau avant, passez à la procédure indiquée ci-dessous.

6. À l'aide d'un petit tournevis à tête plate, soulevez le loquet noir et retirez-le. Notez l'orientation du loquet à des fins de repose.



7. Poussez le levier vers l'intérieur comme indiqué et pressez le cadre métallique de l'instrument pour libérer le plastique du panneau avant.

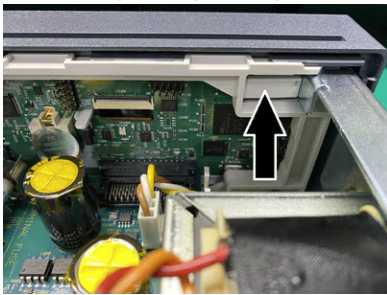

8. Faites glisser le panneau avant vers l'extérieur.
9. Faites glisser la plaque de fixation en plastique blanc vers la droite et soulevez-la sur le côté gauche pour la retirer.

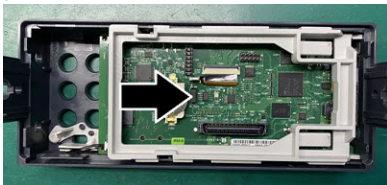

10. Retirez la carte à circuit imprimé du panneau avant en tenant le boîtier du connecteur illustré ci-dessous et en l'extrayant.

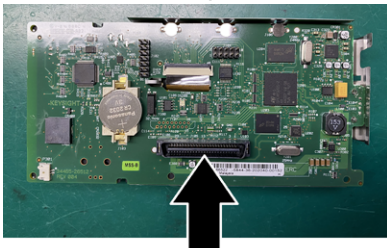

Entretien et réparation

11. Retirez la protection contre les décharges électrostatiques en l'extrayant doucement du boîtier en plastique auquel elle est fixée.

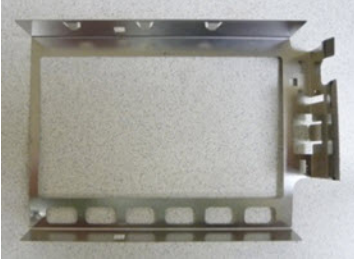

La procédure de démontage est terminée. Pour remonter l'instrument, effectuez la procédure dans le sens inverse.

Remplacement de la batterie

Cette section décrit la procédure à suivre pour remplacer la batterie sur le panneau avant de l'instrument.

AVERTISSEMENT

Seules des personnes qualifiées, formées à la maintenance et conscientes des risques d'électrocution encourus peuvent démonter les capots de l'instrument. Débranchez toujours le cordon d'alimentation et tous les circuits externes avant de démonter le capot de l'instrument. Certains circuits sont actifs et sont donc encore alimentés même lorsque l'interrupteur d'alimentation est en position d'arrêt.

Débranchez systématiquement l'ensemble des entrées, des cordons et des câbles avant de démonter l'instrument.

Outils nécessaires

- Tournevis Torx T20 (essentiellement pour le démontage)
- Petit tournevis à tête plate (pour l'extraction)

Procédure

(Les images ci-dessous ont été fournies gracieusement par Keystone Electronics Corp.)

1. Mettez l'instrument hors tension et débranchez tous les cordons de mesure et autres câbles, notamment le cordon d'alimentation, avant de poursuivre.
2. Suivez la **procédure de démontage** pour démonter l'instrument.
3. Recherchez la batterie sur le panneau avant et placez la pointe du tournevis sous la batterie, comme indiqué.

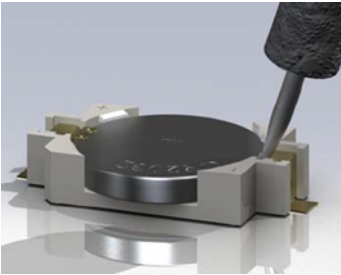

4. À l'aide du tournevis, extrayez la batterie de son compartiment.

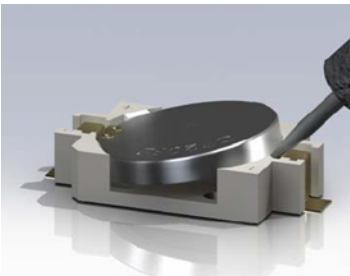

5. Retirez la batterie et mettez-la au rebut ou recyclez-la conformément à toutes les réglementations en vigueur.
6. Positionnez la batterie neuve dans son compartiment, le côté + orienté vers le haut. Appuyez doucement sur la batterie pour la caler dans le compartiment.

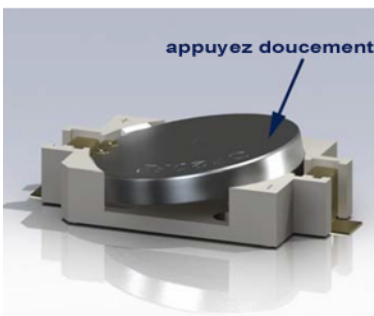

7. Remontez complètement l'instrument avant de brancher des câbles ou des cordons.

La procédure de remplacement de la batterie est terminée.

Remplacement des fusibles d'entrée de courant 3 A et 10 A

Cette section décrit la procédure de test et de remplacement des fusibles d'entrée de courant 3 A et 10 A dans l'instrument.

AVERTISSEMENT

Seules des personnes qualifiées, formées à la maintenance et conscientes des risques d'électrocution encourus peuvent démonter les capots de l'instrument. Débranchez toujours le cordon d'alimentation et tous les circuits externes avant de démonter le capot de l'instrument. Certains circuits sont actifs et sont donc encore alimentés même lorsque l'interrupteur d'alimentation est en position d'arrêt.

Débranchez systématiquement l'ensemble des entrées, des cordons et des câbles avant de démonter l'instrument.

MISE EN GARDE

Ne tournez pas la vis qui maintient le couvercle en place, sous peine de compromettre l'étalonnage de l'instrument.



Outils nécessaires

- Tournevis Torx T20 (essentiellement pour le démontage)
- Petit tournevis à tête plate (pour l'extraction)

Test des fusibles

Entrée de courant 3 A

Pour savoir si l'entrée de courant 3 A de l'instrument contient un fusible qui doit être remplacé, appuyez sur la touche [**Cont**] pour placer le multimètre numérique en mode de mesure de continuité, et court-circuitez la borne d'entrée HI sur la borne de courant 3 A. Si la mesure affiche l'état OPEN, l'un des deux fusibles doit être remplacé. Un fusible est accessible à partir du panneau arrière de l'instrument, l'autre est interne.

Si l'entrée de courant 3 A contient un fusible défectueux, il est très probable qu'il s'agisse du fusible accessible dans l'angle inférieur gauche du panneau arrière de l'instrument (référence 2110-1547, 3,15 A, 500 VAC/ 400 VDC, retard). À l'aide d'un simple tournevis à tête plate, tournez le porte-fusible dans le sens inverse des aiguilles d'une montre et accédez au fusible. Posez le nouveau fusible dans le porte-fusible et réinsérez l'ensemble dans l'instrument, en tournant le porte-fusible dans le sens des aiguilles d'une montre pour le mettre en place.

Si l'entrée 3 A comporte toujours un fusible défectueux, remplacez le fusible d'entrée de courant 3 A interne comme décrit ci-dessous.

Entrée de courant 10 A (34461A/65A/70A uniquement)

Pour savoir si l'entrée de courant 10 A de l'instrument contient un fusible qui doit être remplacé, appuyez sur la touche [**Cont**] pour placer le multimètre numérique en mode de mesure de continuité, et court-circuitez la borne d'entrée HI sur la borne de courant 10 A. Si la mesure indique l'état OPEN, remplacez le fusible d'entrée de courant 10 A interne comme décrit ci-dessous.

Procédure de remplacement des fusibles internes

Les deux fusibles d'entrée de courant interne portent la référence 2110-1402 et sont des fusibles à réaction rapide de 11 A, 1 000 V. Pour remplacer un fusible interne, procédez comme suit :

1. Mettez l'instrument hors tension et débranchez tous les cordons de mesure et autres câbles, notamment le cordon d'alimentation, avant de poursuivre.
2. Suivez la **procédure de démontage** pour démonter l'instrument.
3. Localisez le fusible à remplacer, comme indiqué ci-dessous.

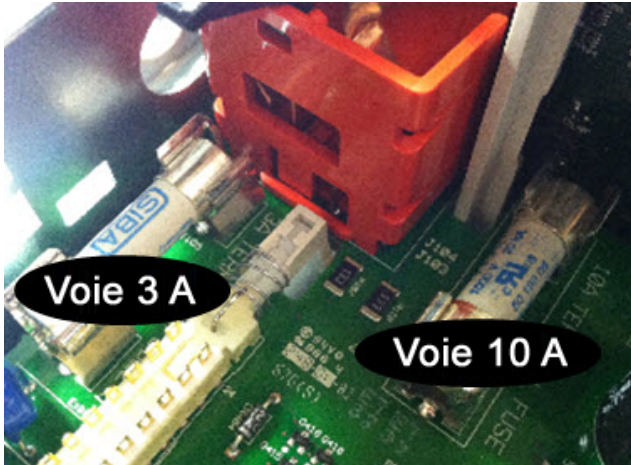

4. À l'aide du tournevis, extrayez le fusible du porte-fusible, en veillant à ne pas endommager la carte du circuit. Pour le fusible 3 A, il peut être plus facile d'accéder au fusible sur le côté, à travers l'ouverture rectangulaire de l'enveloppe métallique.
5. Retirez le fusible.
6. Positionnez le nouveau fusible dans le porte-fusible. Appuyez doucement sur le fusible pour le caler dans son support.
7. Remontez complètement l'instrument avant de brancher des câbles ou des cordons.

La procédure de remplacement des fusibles est terminée.

Installation de l'interface GPIB en option

AVERTISSEMENT

Cette procédure ne doit être effectuée que par des techniciens de maintenance qualifiés. Mettez l'instrument hors tension et débranchez tous les cordons de mesure et autres câbles, notamment le cordon d'alimentation, avant de poursuivre.

Outils nécessaires

Les outils suivants sont nécessaires.

- Clé Torx T10

Procédure d'installation

Mettez l'instrument hors tension et débranchez tous les cordons de mesure et autres câbles, notamment le cordon d'alimentation, avant de poursuivre.

À l'aide de la clé Torx, retirez la vis du couvercle GPIB. Conservez la vis en vue d'une utilisation ultérieure dans cette procédure. Puis, déposez le couvercle en le faisant glisser vers la gauche.

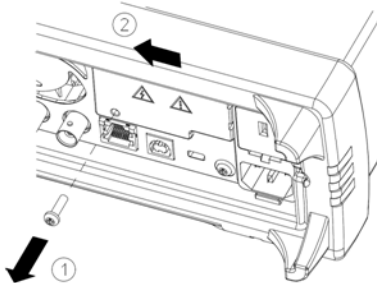

AVERTISSEMENT

Conservez le couvercle GPIB

Après avoir installé l'option GPIB, conservez le couvercle en vue d'une utilisation ultérieure au cas où vous auriez besoin de supprimer l'option. Vous ne devez jamais brancher l'instrument à l'alimentation secteur ou à des entrées sur les bornes de mesure sans vous être préalablement assuré que le module ou le couvercle GPIB recouvre parfaitement l'ouverture du panneau arrière.

À l'intérieur de l'unité, recherchez le connecteur du câble fixé au module GPIB.

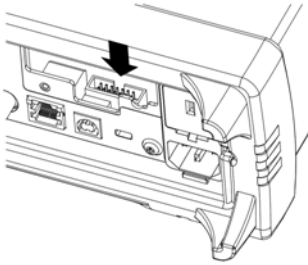

Pliez le câble afin qu'il s'étende au-dessus de la carte de circuit. Fixez le câble au connecteur qui a été localisé à l'étape précédente.

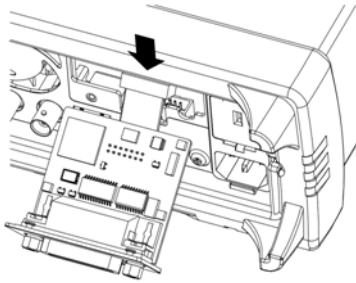

Insérez le module dans l'unité et faites glisser la carte GPIB vers la droite afin qu'elle s'aligne sur l'enveloppe métallique de l'instrument. À l'aide de la vis qui a été déposée ci-dessus, mettez la plaque GPIB en place.

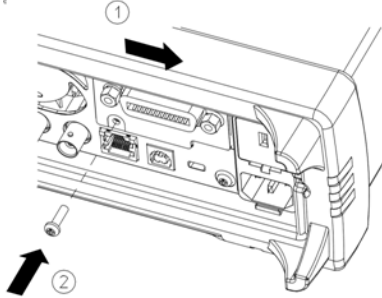

La procédure d'installation du module GPIB est terminée.

Remplacement du code de sécurité

Le code de sécurité de l'instrument est réglé sur AT3446XA en usine. S'il a été modifié et si vous ne vous en souvenez plus, vous pouvez rétablir sa valeur par défaut en suivant l'une des deux procédures ci-dessous.

Quelle procédure dois-je suivre ?

Sur le panneau avant de l'instrument, appuyez sur **[Shift]** > **[Help]** > **About** pour afficher la version du microprogramme de l'instrument. Voici un exemple d'affichage :

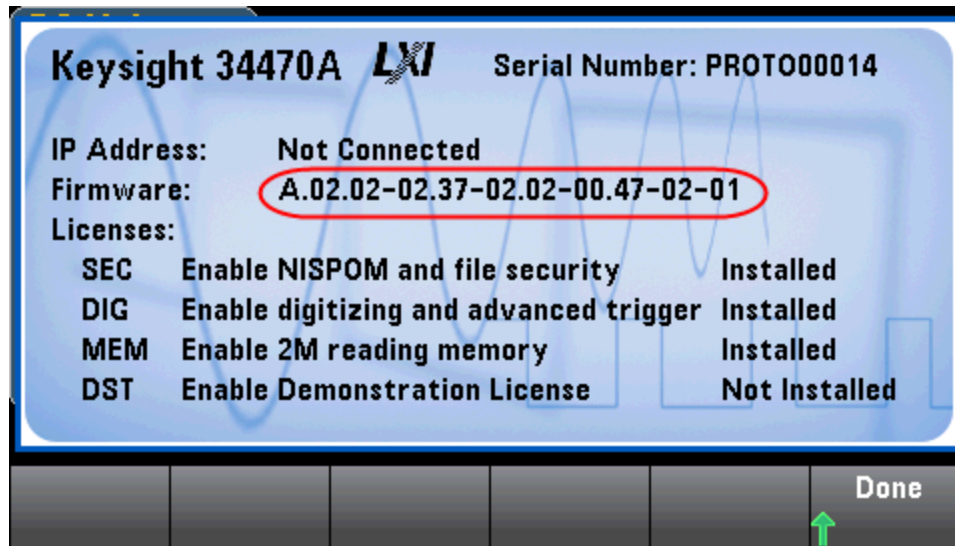

Les deux derniers chiffres de la révision du microprogramme indiquent la révision de la carte PC du panneau avant et l'une des deux procédures à suivre. Si la révision du microprogramme se termine par 02 ou supérieur, suivez la **procédure A**. Si elle se termine par 01, suivez la **procédure B**.



En cas de problème, contactez Keysight Technologies pour obtenir une assistance technique.

Aux États-Unis : (800) 829-4444

En Europe : 31 20 547 2111

Au Japon : 0120-421-345

Pour contacter Keysight dans le monde entier ou votre représentant Keysight Technologies, rendez-vous sur www.keysight.com/find/assist.

Procédure A : pour les révisions de microprogramme se terminant par 02 ou supérieur

AVERTISSEMENT

Cette procédure ne doit être effectuée que par des techniciens de maintenance qualifiés. Mettez l'instrument hors tension et débranchez tous les cordons de mesure et autres câbles, notamment le cordon d'alimentation, avant de poursuivre.

1. Suivez la **procédure de démontage** pour démonter l'instrument.
2. Recherchez le connecteur J102 sur la carte du panneau avant. Court-circuitez les broches A1 à B1, comme indiqué par la ligne orange ci-dessous.

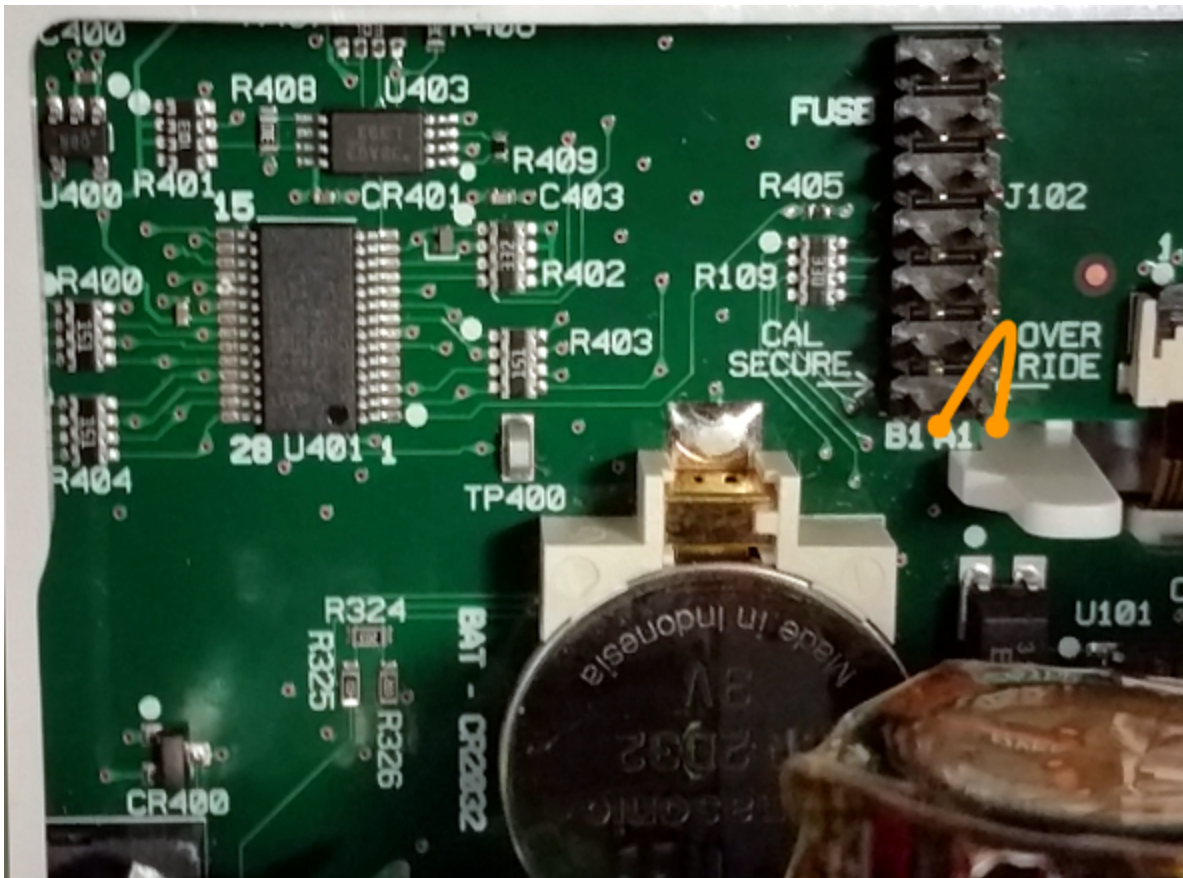

3. Remontez l'instrument, branchez-le et allumez-le ; l'instrument génère une erreur et émet un signal sonore (cela est normal). Patientez 30 à 40 secondes jusqu'à son initialisation complète.

Entretien et réparation

4. Rétablissez les réglages d'usine par défaut du code de sécurité :
 - a. Appuyez sur **[Shift]** > **[Utility]** > **Test / Admin** > **Security** > **New Code**.
 - b. Saisissez le nouveau code d'accès AT3446XA.
 - c. Appuyez sur **Done**.
 - d. Vérifiez le nouveau code et appuyez sur **Yes** pour valider la modification.
5. Mettez l'instrument hors tension, démontez-le et retirez la fiche de court-circuit. Remontez ensuite l'instrument pour terminer la procédure de réinitialisation du code de sécurité.

Procédure B : pour les révisions de microprogramme se terminant par 01

AVERTISSEMENT

Cette procédure ne doit être effectuée que par des techniciens de maintenance qualifiés. Mettez l'instrument hors tension et débranchez tous les cordons de mesure et autres câbles, notamment le cordon d'alimentation, avant de poursuivre.

1. Suivez la **procédure de démontage** pour démonter l'instrument.
2. Recherchez le connecteur J102 sur la carte du panneau avant. Court-circuitez les broches A1 à A6 ou A7, comme indiqué par les lignes orange ci-dessous. Il n'est pas nécessaire de court-circuiter les deux broches sur A1 ; une seule broche suffit.

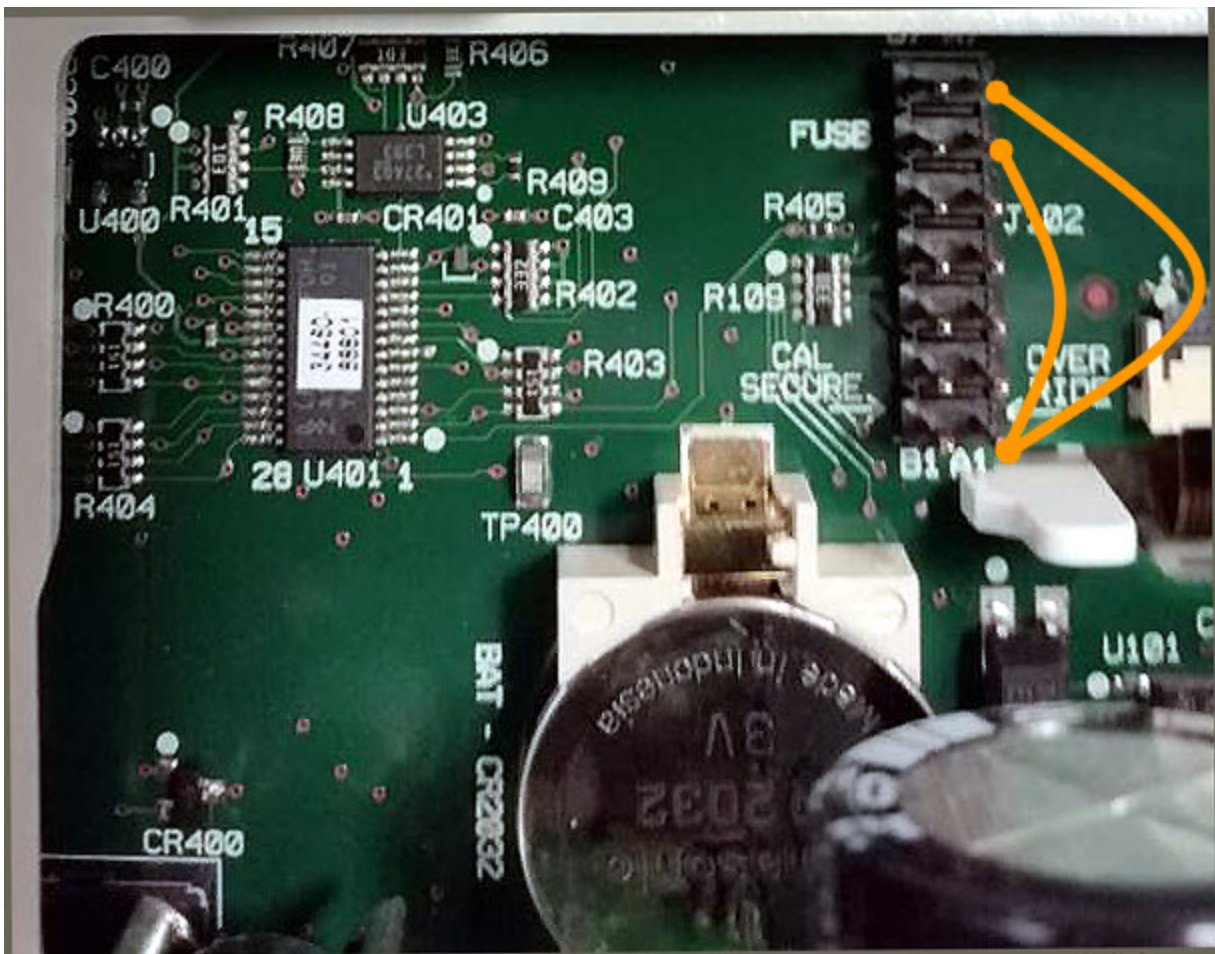

3. Remontez l'instrument, branchez-le et allumez-le ; l'instrument génère une erreur et émet un signal sonore (cela est normal). Patientez 30 à 40 secondes jusqu'à son initialisation complète.

Vérification du fonctionnement

4. Rétablissez les réglages d'usine par défaut du code de sécurité :
 - a. Appuyez sur **[Shift] > [Utility] > Test / Admin > Security > New Code**.
 - b. Saisissez le nouveau code d'accès AT3446XA.
 - c. Appuyez sur **Done**.
 - d. Vérifiez le nouveau code et appuyez sur **Yes** pour valider la modification.
5. Mettez l'instrument hors tension, démontez-le et retirez la fiche de court-circuit. Remontez ensuite l'instrument pour terminer la procédure de réinitialisation du code de sécurité.

Vérification du fonctionnement

Utilisez les tests de vérification du fonctionnement pour vérifier les performances de mesure de l'instrument à l'aide des spécifications figurant sur la fiche technique de l'instrument.

Il existe trois niveaux différents de tests de vérification du fonctionnement :

- **Autotest (deux types)** : tests de vérification internes qui garantissent le bon fonctionnement de l'instrument, comme décrit [ici](#).
- **Vérification rapide** : combinaison des autotests internes et des tests de vérification sélectionnés.
- **Tests de vérification du fonctionnement** : ensemble complet de tests recommandés comme test de recette à la réception de l'instrument ou après avoir effectué des réglages :
- Vérification du décalage du zéro
- Vérification du gain en tension et courant continus
- Vérification de la précision de fréquence
- Vérification de la tension et du courant alternatifs
- Vérification de courant élevé
- Vérification des mesures de capacité (test de vérification en option)

Contrôle rapide du fonctionnement

Le contrôle rapide du fonctionnement regroupe l'autotest interne et un test de fonctionnement réduit (spécifié par la lettre Q dans les tests de vérification du fonctionnement). Ce test constitue une méthode simple de vérification du fonctionnement de l'instrument et de respect des spécifications. Ces tests représentent l'ensemble minimal de vérifications du fonctionnement recommandés après une intervention de maintenance. Le contrôle du fonctionnement de l'instrument pour les points de contrôle rapide (désignés par Q) vérifie le fonctionnement des mécanismes « normaux » de dérive de la précision. Ce test ne vérifie pas les défauts anormaux des composants.

Pour effectuer le contrôle rapide du fonctionnement, procédez comme suit :

- Effectuez un **autotest**.
- Effectuez uniquement les tests de vérification du fonctionnement signalés par la lettre **Q**.

Si l'instrument échoue à la vérification rapide du fonctionnement, un réglage ou une réparation sont nécessaires.

La vérification rapide du fonctionnement peut être limitée par les facteurs décrits à la section suivante (*Tests de vérification du fonctionnement*).

Tests de vérification du fonctionnement

Les tests de vérification du fonctionnement sont recommandés comme tests de recette technique lorsque vous recevez l'instrument. Les résultats de ces tests de recette doivent être comparés aux limites de test sur 90 jours. Vous ne devez utiliser les limites de test de 24 heures qu'à des fins de vérification dans les 24 heures suivant la procédure de réglage.

Si un étalon Fluke 5725A n'est pas disponible, la vérification du courant peut être limitée à 2 A. Cela limitera l'étendue de la vérification sur les plages 10A à seulement 2 A.

Si l'instrument échoue aux tests de vérification du fonctionnement, un réglage ou une réparation sont nécessaires.

Pour réinitialiser la date utilisée pour déterminer les spécifications par rapport au temps, un étalonnage avec réglage est nécessaire.

Les erreurs autorisées pour la vérification sont les spécifications publiées (reportez-vous à la fiche technique de l'instrument à l'adresse www.keysight.com/find/truevolt-doc. Les périodes indiquées dans les spécifications publiées sont celles qui commencent à la date du dernier étalonnage complet.

Équipement de test recommandé

L'équipement nécessaire aux tests de vérification du fonctionnement et à la procédure d'étalonnage est répertorié ci-dessous. Si l'instrument recommandé n'est pas disponible, vous pouvez le remplacer par un autre de précision équivalente.

Il est également possible d'utiliser le multimètre numérique 8½ chiffres Keysight 3458A pour mesurer des sources moins précises, mais néanmoins stables. La valeur de sortie mesurée à partir de la source peut être introduite dans l'instrument comme valeur d'étalonnage cible.

Application	Équipement recommandé
Étalonnage du zéro	Keysight 34172B
Tension continue	Fluke 5720A
Courant continu	Fluke 5720A
Résistance	Fluke 5720A
Tension alternative	Fluke 5720A
Courant alternatif	Fluke 5720A
Fréquence	Générateur de signaux arbitraires/fonctions Keysight série 33500B
Courant élevé	Fluke 5725A
Capacité (en option)	Norme de capacité SCA-1uF

Vérification du décalage du zéro

Cette procédure permet de vérifier les performances de décalage du zéro de l'instrument. Les vérifications sont uniquement effectuées pour les fonctions et les plages dotées de constantes d'étalonnage uniques. Les mesures sont vérifiées pour chaque fonction et plage comme décrit ci-dessous.

1. Assurez-vous d'avoir lu la section **Considérations relatives aux tests**.
2. Installez la fiche de court-circuit d'étalonnage 34172B (ou équivalent) sur les bornes d'entrée du panneau avant. Sélectionnez les bornes d'entrée avant à l'aide du commutateur Front/Rear (Avant/Arrière).
3. Configurez chaque fonction et plage dans l'ordre indiqué dans le tableau ci-dessous correspondant au numéro de modèle du multimètre numérique. Effectuez une mesure et renvoyez le résultat. Comparez les résultats de mesure aux limites de test indiquées ci-dessous.
4. Installez la fiche de court-circuit d'étalonnage 34172B (ou équivalent) sur les bornes d'entrée du panneau arrière. Sélectionnez les bornes d'entrée arrière à l'aide du commutateur Front/Rear.
5. Configurez chaque fonction et plage dans l'ordre indiqué dans le tableau ci-dessous correspondant au numéro de modèle du multimètre numérique. Effectuez une mesure et renvoyez le résultat. Comparez les résultats de mesure aux limites de test indiquées ci-dessous.

Valeurs V CA pour le multimètre numérique 34460A							
Entrée	Fonction ^[1]	Plage	Vérification rapide	Erreur par rapport à la valeur nominale			
				24 heures	90 jours	1 an	2 ans
Ouvrir	Courant continu	100 μ A	Q	$\pm 0,02 \mu$ A	$\pm 0,025 \mu$ A		
		1 mA		$\pm 0,060 \mu$ A			
		10 mA		$\pm 2 \mu$ A			
		100 mA		$\pm 4 \mu$ A	$\pm 5 \mu$ A		
		1 A		$\pm 60 \mu$ A	$\pm 100 \mu$ A		
		3 A		$\pm 600 \mu$ A			
Court-circuit	Tension continue	100 mV	Q	$\pm 6 \mu$ V	$\pm 6,5 \mu$ V		
		1 V		$\pm 9 \mu$ V	$\pm 10 \mu$ V		
		10 V		$\pm 40 \mu$ V	$\pm 50 \mu$ V		
		100 V		$\pm 600 \mu$ V			
		1 000 V		± 6 mV	± 10 mV		
Court-circuit	Résistance en 4 fils	100 Ω		± 6 m Ω	± 7 m Ω		
		1 k Ω		± 8 m Ω	± 10 m Ω		
		10 k Ω	Q	± 50 m Ω	± 100 m Ω		
		100 k Ω		± 500 m Ω	$\pm 1 \Omega$		
		1 M Ω		$\pm 10 \Omega$			
		10 M Ω		$\pm 100 \Omega$			

[1]Sélectionnez 10 PLC.

Q : Point de test de vérification rapide du fonctionnement.

Valeurs V CA pour le multimètre numérique 34461A							
Entrée	Fonction ^[1]	Plage	Vérification rapide	Erreur par rapport à la valeur nominale			
				24 heures	90 jours	1 an	2 ans
Ouvrir	Courant continu	100 μ A	Q	$\pm 0,02 \mu$ A	$\pm 0,025 \mu$ A		
		1 mA		$\pm 0,060 \mu$ A			
		10 mA		$\pm 2 \mu$ A			
		100 mA		$\pm 4 \mu$ A	$\pm 5 \mu$ A		
		1 A		$\pm 60 \mu$ A	$\pm 100 \mu$ A		
		3 A		$\pm 600 \mu$ A			
		10 A		± 1 mA			
Court-circuit	Tension continue	100 mV	Q	$\pm 3 \mu$ V	$\pm 3,5 \mu$ V		
		1 V		$\pm 6 \mu$ V	$\pm 7 \mu$ V		
		10 V		$\pm 40 \mu$ V	$\pm 50 \mu$ V		
		100 V		$\pm 600 \mu$ V			
		1 000 V		± 6 mV	± 10 mV		
Court-circuit	Résistance en 4 fils	100 Ω		± 3 m Ω	± 4 m Ω		
		1 k Ω		± 5 m Ω	± 10 m Ω		
		10 k Ω	Q	± 50 m Ω	± 100 m Ω		
		100 k Ω		± 500 m Ω	$\pm 1 \Omega$		
		1 M Ω		$\pm 10 \Omega$			
		10 M Ω		$\pm 100 \Omega$			

^[1]Sélectionnez 10 PLC.

Q : Point de test de vérification rapide du fonctionnement.

Valeurs pour le multimètre numérique 34465A							
Entrée	Fonction ^[1]	Plage	Vérification rapide	Erreur par rapport à la valeur nominale			
				24 heures	90 jours	1 an	2 ans
Circuit ouvert	Courant continu	1 μ A		± 50 pA (50E-12 A) ^[2]			
		10 μ A		± 200 pA (± 200.0 E-12 A) ^[2]			
		100 μ A	Q	$\pm 0,001$ μ A ^[2]			
		1 mA		$\pm 0,030$ μ A	$\pm 0,050$ μ A		
		10 mA		± 2 μ A			
		100 mA		± 4 μ A	± 5 μ A		
		1 A		± 60 μ A	± 100 μ A		
		3 A		± 600 μ A			
		10 A		± 1 ma			
Court-circuit	Tension continue	100 mV	Q	± 3 μ V	$\pm 3,5$ μ V		
		1 V		± 4 μ V			
		10 V		± 30 μ V	± 40 μ V		
		100 V		± 600 μ V			
		1 000 V		± 6 mV			
Court-circuit	Résistance en 4 fils	100 Ω		± 3 m Ω	± 4 m Ω		
		1 k Ω		± 5 m Ω			
		10 k Ω	Q	± 50 m Ω			
		100 k Ω		± 500 m Ω			
		1 M Ω		± 5 Ω			
		10 M Ω		± 100 Ω			
Court-circuit	Résistance en 2 fils	100 M Ω		1 k Ω			

^[1]Sélectionnez 10 PLC.

^[2]Les valeurs sont des valeurs types et ces plages sont étalonnées en interne.

Q : Point de test de vérification rapide du fonctionnement.

Valeurs pour le multimètre numérique 34470A							
Entrée	Fonction ^[1]	Plage	Vérification rapide	Erreur par rapport à la valeur nominale			
				24 heures	90 jours	1 an	2 ans
Circuit ouvert	Courant continu	1 µA		± 50 pA (50E-12 A) ^[2]			
		10 µA		± 200 pA (± 200.0E-12 A) ^[2]			
		100 µA	Q	± 0,001 µA ^[2]			
		1 mA		± 0,030 µA	± 0,050 µA		
		10 mA		± 2 µA			
		100 mA		± 4 µA	± 5 µA		
		1 A		± 60 µA	± 100 µA		
		3 A		± 600 µA			
		10 A		± 1 ma			
Court-circuit	Tension continue	100 mV	Q	± 3 µV	± 3,5 µV		
		1 V		± 4 µV			
		10 V		± 20 µV			
		100 V		± 600 µV			
		1 000 V		± 6 mV			
Court-circuit	Résistance en 4 fils	100 Ω		± 3 mΩ	± 4 mΩ		
		1 kΩ		± 5 mΩ			
		10 kΩ	Q	± 50 mΩ			
		100 kΩ		± 500 mΩ			
		1 MΩ		± 5 Ω			
		10 MΩ		± 100 Ω			
Court-circuit	Résistance en 2 fils	100 MΩ		1 kΩ			

[1]Sélectionnez 10 PLC.

[2]Les valeurs sont des valeurs types et ces plages sont étalonnées en interne.

Q : Point de test de vérification rapide du fonctionnement.

Vérification du gain en tension et courant continu

Cette procédure permet de vérifier le gain en tension et courant continu.

1. Assurez-vous d'avoir lu la section **Considérations relatives aux tests**.
2. Raccordez l'appareil étalon aux bornes d'entrée. Pour les modèles 34461A/65A/70A, utilisez les bornes d'entrée du panneau avant et sélectionnez les bornes d'entrée avant à l'aide du commutateur avant/arrière.
3. Configurez chaque fonction et plage dans l'ordre indiqué dans le tableau ci-dessous correspondant au numéro de modèle du multimètre numérique. Saisissez l'entrée indiquée dans le tableau ci-dessous.
4. Effectuez une mesure et renvoyez le résultat. Comparez les résultats de mesure aux limites de test indiquées ci-dessous. (Assurez-vous qu'une stabilisation correcte de la source est possible.)

Valeurs V CA pour le multimètre numérique 34460A								
Entrée			Vérification rapide	Erreur par rapport à la valeur nominale				
Tension	Fonction ^[1]	Plage		24 heures	90 jours	1 an	2 ans	
100 mV	Tension continue	100 mV		± 10 µV	± 13,5 µV	± 15,5 µV	± 18 µV	
-100 mV								
1 V		1 V		± 39 µV	± 70 µV	± 90 µV	± 115 µV	
-1 V								
4 V		10 V		± 140 µV	± 250 µV	± 350 µV	± 450 µV	
10 V		10 V		Q	± 290 µV	± 550 µV	± 800 µV	± 1,1 mV
-10 V								
100 V		100 V		Q	± 3,6 mV	± 7,1 mV	± 9,1 mV	± 11,6 mV
-100 V								
1 000 V		1 000 V			± 36 mV	± 75 mV	± 95 mV	± 120 mV
-500 V								

[1]Sélectionnez 10 PLC.

Q : Point de test de vérification rapide du fonctionnement.

Vérification du fonctionnement

Valeurs V CA pour le multimètre numérique 34460A								
Entrée			Vérification rapide	Erreur par rapport à la valeur nominale				
Courant	Fonction ^[1]	Plage		24 heures	90 jours	1 an	2 ans	
2 A	Courant continu	3 A		± 4,2 mA	± 4,6 mA	± 4,6 mA	± 5,2 mA	
1 A		1 A	Q	± 560 µA	± 900 µA	± 1,1 mA	± 1,3 mA	
100 mA		100 mA		± 14 µA	± 35 µA	± 55 µA	± 65 µA	
10 mA		10 mA	Q	± 2,7 µA	± 5 µA	± 7 µA	± 8 µA	
1 mA		1 mA		± 0,13 µA	± 0,36 µA	± 0,56 µA	± 0,66 µA	
100 µA		100 µA			± 0,03 µA	± 0,065 µA	± 0,075 µA	± 0,085 µA

[1]Sélectionnez 10 PLC.

Q : Point de test de vérification rapide du fonctionnement.

Valeurs V CA pour le multimètre numérique 34460A							
Entrée			Vérification rapide	Erreur par rapport à la valeur nominale			
Résistance	Fonction ^[1]	Plage		24 heures	90 jours	1 an	2 ans
100 Ω	Résistance en 4 fils	100 Ω		± 10 mΩ	± 18 mΩ	± 21 mΩ	± 24 mΩ
1 kΩ		1 kΩ	Q	± 38 mΩ	± 120 mΩ	± 150 mΩ	± 180 mΩ
10 kΩ		10 kΩ		± 350 mΩ	± 1,2 Ω	± 1,5 Ω	± 1,8 Ω
100 kΩ		100 kΩ		± 3,5 Ω	± 12 Ω	± 15 Ω	± 18 Ω
1 MΩ		1 MΩ		± 40 Ω	± 120 Ω	± 150 Ω	± 180 Ω
10 MΩ		10 MΩ	Q	± 1,6 kΩ	± 2,1 kΩ	± 4,1 kΩ	± 6,1 kΩ
100 MΩ	Résistance en 2 fils	100 MΩ		± 310 kΩ	± 810 kΩ		

[1]Sélectionnez 10 PLC.

Q : Point de test de vérification rapide du fonctionnement.

Valeurs V CA pour le multimètre numérique 34461A								
Entrée				Erreur par rapport à la valeur nominale				
Tension	Fonction ^[1]	Plage	Vérification rapide	24 heures	90 jours	1 an	2 ans	
100 mV	Tension continue	100 mV		± 6 µV	± 7,5 µV	± 8,5 µV	± 10 µV	
-100 mV								
1 V		1 V		± 26 µV	± 37 µV	± 47 µV	± 62 µV	
-1 V								
4 V		10 V			± 100 µV	± 130 µV	± 190 µV	± 230 µV
10 V				Q	± 190 µV	± 250 µV	± 400 µV	± 500 µV
-10 V								
100 V			100 V		± 2,6 mV	± 4,1 mV	± 5,1 mV	± 6,6 mV
-100 V		Q						
1 000 V		1 000 V			± 26 mV	± 45 mV	± 55 mV	± 70 mV
-500 V					± 16 mV	± 27,5 mV	± 32,5 mV	± 40 mV

[1]Sélectionnez 10 PLC.

Q : Point de test de vérification rapide du fonctionnement.

Valeurs V CA pour le multimètre numérique 34461A								
Entrée				Erreur par rapport à la valeur nominale				
Courant	Fonction ^[1]	Plage	Vérification rapide	24 heures	90 jours	1 an	2 ans	
2 A	Courant continu	3 A		± 4,2 mA	± 4,6 mA	± 4,6 mA	± 5,2 mA	
1 A		1 A	Q	± 560 µA	± 900 µA	± 1,1 mA	± 1,3 mA	
100 mA		100 mA		± 14 µA	± 35 µA	± 55 µA	± 65 µA	
10 mA		10 mA	Q	± 2,7 µA	± 5 µA	± 7 µA	± 8 µA	
1 mA		1 mA		± 0,13 µA	± 0,36 µA	± 0,56 µA	± 0,66 µA	
100 µA		100 µA			± 0,03 µA	± 0,065 µA	± 0,075 µA	± 0,085 µA

[1]Sélectionnez 10 PLC.

Q : Point de test de vérification rapide du fonctionnement.

Valeurs V CA pour le multimètre numérique 34461A							
Entrée				Erreur par rapport à la valeur nominale			
Résistance	Fonction ^[1]	Plage	Vérification rapide	24 heures	90 jours	1 an	2 ans
100 Ω	Résistance en 4 fils	100 Ω		± 6 mΩ	± 12 mΩ	± 14 mΩ	± 16 mΩ
1 kΩ		1 kΩ	Q	± 25 mΩ	± 90 mΩ	± 110 mΩ	± 130 mΩ
10 kΩ		10 kΩ		± 250 mΩ	± 900 mΩ	± 1,1 Ω	± 1,3 Ω
100 kΩ		100 kΩ		± 2,5 Ω	± 9 Ω	± 11 Ω	± 13 Ω
1 MΩ		1 MΩ		± 30 Ω	± 90 Ω	± 110 Ω	± 130 Ω
10 MΩ		10 MΩ		Q	± 1,6 kΩ	± 2,1 kΩ	± 4,1 kΩ
100 MΩ	Résistance en 2 fils	100 MΩ		± 310 kΩ	± 810 kΩ		

^[1]Sélectionnez 10 PLC.

Q : Point de test de vérification rapide du fonctionnement.

Valeurs pour le multimètre numérique 34465A								
Entrée				Erreur par rapport à la valeur nominale				
Courant	Fonction ^[1]	Plage	Vérification rapide	24 heures	90 jours	1 an	2 ans	
2 A	Courant continu	3 A		± 4,2 mA	± 4,6 mA	± 4,6 mA	± 5,2 mA	
1 A		1 A	Q	± 560 μA	± 800 μA	± 900 μA	± 1,1 mA	
100 mA		100 mA		± 14 μA	± 35 μA	± 55 μA	± 65 μA	
10 mA		10 mA		Q	± 2,7 μA	± 5 μA	± 7 μA	± 8 μA
1 mA		1 mA			± 0,1 μA	± 0,35 μA	± 0,55 μA	± 0,65 μA

^[1]Sélectionnez 10 PLC.

Q : Point de test de vérification rapide du fonctionnement.

Valeurs pour le multimètre numérique 34465A								
Entrée			Vérification rapide	Erreur par rapport à la valeur nominale				
Tension	Fonction ^[1]	Plage		24 heures	90 jours	1 an	2 ans	
100 mV	Tension continue	100 mV		± 6 µV	± 7,5 µV	± 8,5 µV	± 10 µV	
-100 mV								
1 V		1 V		± 19 µV	± 29 µV	± 39 µV	± 54 µV	
-1 V								
4 V		10 V		± 70 µV	± 120 µV	± 160 µV	± 220 µV	
10 V			Q	± 130 µV	± 240 µV	± 340 µV	± 490 µV	
-10 V								
100 V								
-100 V		100 V		Q	± 2,6 mV	± 4,1 mV	± 4,6 mV	± 6,1 mV
1 000 V								
-500 V		1 000 V			± 36 mV	± 51 mV	± 56 mV	± 71 mV
						± 16 mV	± 23,5 mV	± 26 mV

[1]Sélectionnez 10 PLC.

Q : Point de test de vérification rapide du fonctionnement.

Valeurs pour le multimètre numérique 34465A							
Entrée			Vérification rapide	Erreur par rapport à la valeur nominale			
Résistance	Fonction ^[1]	Plage		24 heures	90 jours	1 an	2 ans
100 Ω	Résistance en 4 fils	100 Ω		± 6 mΩ	± 9 mΩ	± 10 mΩ	± 11 mΩ
1 kΩ		1 kΩ	Q	± 25 mΩ	± 35 mΩ	± 45 mΩ	± 55 mΩ
10 kΩ		10 kΩ		± 250 mΩ	± 350 mΩ	± 450 mΩ	± 550 mΩ
100 kΩ		100 kΩ		± 2,5 Ω	± 3,5 Ω	± 4,5 Ω	± 5,5 Ω
1 MΩ		1 MΩ		± 25 Ω	± 65 Ω	± 75 Ω	± 85 Ω
10 MΩ		10 MΩ		± 1,1 kΩ	± 2,1 kΩ	± 2,6 kΩ	± 3,1 kΩ
10 MΩ	Résistance en 2 fils	10 MΩ	Q				
100 MΩ		100 MΩ		± 101 kΩ	± 201 kΩ	± 301 kΩ	± 401 kΩ

[1]Sélectionnez 10 PLC.

Q : Point de test de vérification rapide du fonctionnement.

Vérification du fonctionnement

Valeurs pour le multimètre numérique 34470A							
Entrée				Erreur par rapport à la valeur nominale			
Courant	Fonction ^[1]	Plage	Vérification rapide	24 heures	90 jours	1 an	2 ans
2 A	Courant continu	3 A		± 4,2 mA	± 4,6 mA		± 5,2 mA
1 A		1 A	Q	± 560 µA	± 800 µA	± 900 µA	± 1,1 mA
100 mA		100 mA		± 14 µA	± 35 µA	± 55 µA	± 65 µA
10 mA		10 mA	Q	± 2,7 µA	± 5 µA	± 7 µA	± 8 µA
1 mA		1 mA		± 0,1 µA	± 0,35 µA	± 0,55 µA	± 0,65 µA

[1]Sélectionnez 10 PLC.

Q : Point de test de vérification rapide du fonctionnement.

Valeurs pour le multimètre numérique 34470A								
Entrée				Erreur par rapport à la valeur nominale				
Tension	Fonction ^[1]	Plage	Vérification rapide	24 heures	90 jours	1 an	2 ans	
100 mV	Tension continue	100 mV		± 6 µV	± 7,5 µV		± 8 µV	
-100 mV								
1 V		1 V		± 14 µV	± 19 µV	± 24 µV	± 29 µV	
-1 V								
4 V		10 V		± 52 µV	± 72 µV	± 84 µV	± 100 µV	
10 V			Q	± 100 µV	± 150 µV	± 180 µV	± 220 µV	
-10 V								
100 V		100 V			± 2,6 mV	± 3,8 mV	± 4,4 mV	± 4,6 mV
-100 V			Q					
1 000 V		1 000 V			± 36 mV	± 48 mV	± 54 mV	± 56 mV
-500 V				± 16 mV	± 22 mV	± 25 mV	± 36 mV	

[1]Sélectionnez 10 PLC.

Q : Point de test de vérification rapide du fonctionnement.

Valeurs pour le multimètre numérique 34470A							
Entrée				Erreur par rapport à la valeur nominale			
Résistance	Fonction ^[1]	Plage	Vérification rapide	24 heures	90 jours	1 an	2 ans
100 Ω	Résistance en 4 fils	100 Ω		± 6 mΩ	± 9 mΩ	± 10 mΩ	± 11 mΩ
1 kΩ		1 kΩ	Q	± 25 mΩ	± 35 mΩ	± 45 mΩ	± 55 mΩ
10 kΩ		10 kΩ		± 250 mΩ	± 350 mΩ	± 450 mΩ	± 550 mΩ
100 kΩ		100 kΩ		± 2,5 Ω	± 3,5 Ω	± 4,5 Ω	± 5,5 Ω
1 MΩ		1 MΩ		± 25 Ω	± 65 Ω	± 75 Ω	± 85 Ω
10 MΩ		10 MΩ			± 1,1 kΩ	± 2,1 kΩ	± 2,6 kΩ
10 MΩ	Résistance en 2 fils	10 MΩ	Q				
100 MΩ		100 MΩ		± 101 kΩ	± 201 kΩ	± 301 kΩ	± 401 kΩ

[1]Sélectionnez 10 PLC.

Q : Point de test de vérification rapide du fonctionnement.

Vérification de la précision de fréquence

Configuration : Fréquence (CONFigure:FREQuency DEF, MIN)

1. Assurez-vous d'avoir lu la section **Considérations relatives aux tests**.
2. Sélectionnez la fonction Frequency (Fréquence), la plage par défaut, le filtre 3 Hz et une ouverture de 1 seconde.
3. Connectez le générateur de fonctions/signaux arbitraires Keysight série 33500B aux bornes d'entrée. Pour les modèles 34461A/65A/70A, utilisez les bornes d'entrée du panneau avant et sélectionnez les bornes d'entrée avant à l'aide du commutateur **avant/arrière**.
4. Sélectionnez chaque plage dans l'ordre indiqué ci-dessous. Saisissez la tension et la fréquence d'entrée indiquées. Comparez les résultats de mesure aux limites de test indiquées ci-dessous. (Assurez-vous qu'une stabilisation correcte de la source est possible.)

Valeurs V CA pour le multimètre numérique 34460A							
Entrée			Vérification rapide	Erreur par rapport à la valeur nominale			
V eff	Fréquence	Plage		24 heures	90 jours	1 an	2 ans
0,1 V eff.	10 Hz	1 V eff.		± 3 mHz			± 3,5 mHz
0,01 V eff.	300 kHz	0,1 V eff.	Q	± 60 Hz	± 240 Hz	± 360 Hz	± 510 Hz

Valeurs V CA pour le multimètre numérique 34461A							
Entrée			Vérification rapide	Erreur par rapport à la valeur nominale			
V eff	Fréquence	Plage		24 heures	90 jours	1 an	2 ans
0,1 V eff.	10 Hz	1 V eff.		± 3 mHz			± 3,5 mHz
0,01 V eff.	300 kHz	0,1 V eff.	Q	± 60 Hz	± 180 Hz	± 300 Hz	± 450 Hz

Valeurs pour les multimètres numériques 34465A et 34470A							
Entrée			Vérification rapide	Erreur par rapport à la valeur nominale			
V eff	Fréquence	Plage		24 heures	90 jours	1 an	2 ans
0,1 V eff.	10 Hz	1 V eff.		± 3 mHz			
0,01 V eff.	300 kHz	0,1 V eff.	Q	± 60 Hz	± 150 Hz	± 210 Hz	± 270 Hz

Q : Point de test de vérification rapide du fonctionnement.

Vérification de la tension et du courant alternatifs

Cette procédure permet de vérifier la tension et le courant alternatifs.

1. Assurez-vous d'avoir lu la section **Considérations relatives aux tests**.
2. Raccordez l'appareil étalon aux bornes d'entrée. Pour les modèles 34461A/65A/70A, utilisez les bornes d'entrée du panneau avant et sélectionnez les bornes d'entrée avant à l'aide du commutateur avant/arrière.
3. Réglez les fonctions de voltmètre et d'ampèremètre en courant alternatif et le filtre comme indiqué ci-dessous.
4. Sélectionnez chaque plage dans l'ordre indiqué ci-dessous. Saisissez la tension et la fréquence d'entrée indiquées. Comparez les résultats de mesure aux limites de test indiquées ci-dessous. (Assurez-vous qu'une stabilisation correcte de la source est possible.)

Valeurs V CA pour le multimètre numérique 34460A								
Entrée				Vérification rapide	Erreur par rapport à la valeur nominale			
V eff	Fréquence	Plage	Filtre		24 heures	90 jours	1 an	2 ans
100 mV	1 kHz	100 mV	200 Hz		± 90 µV	± 110 µV	± 120 µV	± 130 µV
	50 kHz				± 170 µV	± 190 µV	± 200 µV	± 210 µV
	300 kHz			Q	± 4,5 mV			
1 V	1 kHz	1 V	200 Hz		± 900 µV	± 1,1 mV	± 1,2 mV	± 1,3 mV
	50 kHz				± 1,7 mV	± 1,9 mV	± 2 mV	± 2,1 mV
	300 kHz				± 45 mV			
0,03 V	1 kHz	10 V	200 Hz		± 2 mV	± 3 mV		
1 V	1 kHz		200 Hz		± 2,7 mV	± 3,8 mV	± 3,9 mV	± 4 mV
10 V	10 Hz		3 Hz		± 9 mV	± 11 mV	± 12 mV	± 13 mV
	100 Hz		20 Hz		± 9 mV	± 11 mV	± 12 mV	± 13 mV
	20 kHz		200 Hz		± 9 mV	± 11 mV	± 12 mV	± 13 mV
	50 kHz		200 Hz	Q	± 17 mV	± 19 mV	± 20 mV	± 21 mV
	100 kHz			± 66 mV	± 71 mV			
300 kHz				± 450 mV				

Vérification du fonctionnement

Valeurs V CA pour le multimètre numérique 34460A								
Entrée				Vérification rapide	Erreur par rapport à la valeur nominale			
V eff	Fréquence	Plage	Filtre		24 heures	90 jours	1 an	2 ans
100 V	1 kHz	100 V	200 Hz	Q	± 90 mV	± 110 mV	± 120 mV	± 130 mV
	50 kHz			± 170 mV	± 190 mV	± 200 mV	± 210 mV	
70 V	300 kHz			± 3,3 V				
750 V	1 kHz	750 V	200 Hz		± 675 mV	± 825 mV	± 900 mV	± 975 mV
210 V	50 kHz			± 573 mV	± 669 mV	± 690 mV	± 711 mV	
70 V	300 kHz			± 6,6 V				

Q : Point de test de vérification rapide du fonctionnement.

Valeurs V CA pour le multimètre numérique 34461A								
Entrée					Erreur par rapport à la valeur nominale			
V eff	Fréquence	Plage	Filtre	Vérification rapide	24 heures	90 jours	1 an	2 ans
100 mV	1 kHz	100 mV	200 Hz		± 60 µV	± 80 µV	± 90 µV	± 100 µV
	50 kHz			± 140 µV	± 160 µV	± 170 µV	± 180 µV	
	300 kHz			Q	± 4,5 mV			
1 V	1 kHz	1 V	200 Hz		± 600 µV	± 800 µV	± 900 µV	± 1 mV
	50 kHz			± 1,4 mV	± 1,6 mV	± 1,7 mV	± 1,8 mV	
	300 kHz				± 45 mV			
0,03 V	1 kHz	10 V	200 Hz		± 2 mV	± 3 mV		
1 V	1 kHz		200 Hz		± 2,4 mV	± 3,5 mV	± 3,6 mV	± 3,7 mV
10 V	10 Hz		3 Hz		± 6 mV	± 8 mV	± 9 mV	± 10 mV
	100 Hz		20 Hz		± 6 mV	± 8 mV	± 9 mV	± 10 mV
	20 kHz		200 Hz		± 6 mV	± 8 mV	± 9 mV	± 10 mV
	50 kHz		200 Hz	Q	± 14 mV	± 16 mV	± 17 mV	± 18 mV
	100 kHz				± 63 mV	± 68 mV		
300 kHz		± 450 mV						
100 V	1 kHz	100 V	200 Hz	Q	± 60 mV	± 80 mV	± 90 mV	± 100 mV
	50 kHz			± 140 mV	± 160 mV	± 170 mV	± 180 mV	
70 V	300 kHz				± 3,3 V			
750 V	1 kHz	750 V	200 Hz		± 450 mV	± 600 mV	± 675 mV	± 750 mV
210 V	50 kHz			± 510 mV	± 606 mV	± 627 mV	± 648 mV	
70 V	300 kHz				± 6,6 V			

Q : Point de test de vérification rapide du fonctionnement.

Valeurs I CA pour les multimètres numériques 34460A et 34461A								
Entrée					Erreur par rapport à la valeur nominale			
Courant, valeur efficace vraie	Fréquence	Plage	Filtre	Vérification rapide	24 heures	90 jours	1 an	2 ans
2 A	1 kHz	3 A	200 Hz		± 5,8 mA			
	5 kHz							
1 A	1 kHz	1 A	200 Hz		± 1,4 mA			
	5 kHz							
100 mA	10 Hz	100 mA	3 Hz		± 140 µA			
	1 kHz		200 Hz					
	5 kHz		200 Hz					
100 µA	1 kHz	10 mA	200 Hz		4,1 µA			
1 mA	1 kHz				5 µA			
10 mA	1 kHz				14 µA			
	5 kHz							
1 mA	1 kHz	1 mA	200 Hz		1,4 µA			
	5 kHz							
100 µA	1 kHz	100 µA	200 Hz		0,14 µA			
	5 kHz			Q				

Q : Point de test de vérification rapide du fonctionnement.

Valeurs V CA pour les multimètres numériques 34465A et 34470A								
Entrée				Vérification rapide	Erreur par rapport à la valeur nominale			
V eff	Fréquence	Plage	Filtre		24 heures	90 jours	1 an	2 ans
100 mV	1 kHz	100 mV	200 Hz		± 40 µV	± 60 µV	± 70 µV	± 80 µV
	50 kHz				± 80 µV	± 90 µV	± 100 µV	± 110 µV
	300 kHz			Q	± 1,1 mV			
1 V	1 kHz	1 V	200 Hz		± 400 µV	± 600 µV	± 700 µV	± 800 µV
	50 kHz				± 800 µV	± 900 µV	± 1 mV	± 1,1 mV
	300 kHz				± 11 mV			
0,03 V	1 kHz	10 V	200 Hz		± 2 mV			
1 V	1 kHz		200 Hz		± 2,2 mV	± 2,4 mV	± 2,5 mV	± 2,6 mV
10 V	10 Hz		3 Hz		± 4 mV	± 6 mV	± 7 mV	± 8 mV
	100 Hz	20 Hz						
	20 kHz	200 Hz						
	50 kHz	200 Hz	Q	± 8 mV	± 9 mV	± 10 mV	± 11 mV	
	100 kHz			± 20 mV				
	300 kHz			± 110 mV				
100 V	1 kHz	100 V	200 Hz	Q	± 40 mV	± 60 mV	± 70 mV	± 80 mV
	50 kHz				± 80 mV	± 90 mV	± 100 mV	± 110 mV
70 V	300 kHz				± 800 mV			
750 V	1 kHz	750 V	200 Hz		± 750 mV	± 900 mV	± 975 mV	± 1,1 V
210 V	50 kHz				± 330 mV	± 351 mV	± 372 mV	± 393 mV
70 V	300 kHz				± 1,5 V			

Q : Point de test de vérification rapide du fonctionnement.

Valeurs I CA pour les multimètres numériques 34465A et 34470A								
Entrée					Erreur par rapport à la valeur nominale			
Courant, valeur efficace vraie	Fréquence	Plage	Filtre	Vérification rapide	24 heures	90 jours	1 an	2 ans
2 A	1 kHz	3 A	200 Hz		± 5,8 mA			
	5 kHz							
1 A	1 kHz	1 A	200 Hz		± 1,1 mA	± 1,3 mA	± 1,4 mA	
	5 kHz							
100 mA	10 Hz	100 mA	3 Hz		± 110 µA	± 130 µA	± 140 µA	
	1 kHz		200 Hz					
	5 kHz		200 Hz	Q				
100 µA	1 kHz	10 mA	200 Hz		± 4,1 µA			
1 mA	1 kHz				± 4,7 µA	± 4,9 µA	± 5 µA	
10 mA	1 kHz				± 11 µA	± 13 µA	± 14 µA	
	5 kHz							
1 mA	1 kHz	1 mA	200 Hz	Q	± 1,1 µA	± 1,3 µA	± 1,4 µA	
	5 kHz							
100 µA	1 kHz	100 µA	200 Hz		± 0,110 µA	± 0,130 µA	± 0,140 µA	
	5 kHz							

Q : Point de test de vérification rapide du fonctionnement.

Vérification de courant élevé

Cette procédure concerne uniquement les modèles 34461A, 34465A et 34470A (et non le modèle 34460A).

Elle permet de vérifier le courant alternatif et continu sur les bornes 10 A.

1. Assurez-vous d'avoir lu la section **Considérations relatives aux tests**.
2. Connectez l'étalon aux bornes d'entrée 10 A avant, puis sélectionnez les bornes d'entrée avant à l'aide du commutateur **avant/arrière**.
3. Sélectionnez chaque fonction dans l'ordre indiqué ci-dessous. Entrez le courant et la fréquence d'entrée indiqués, et pour une mesure I CA, utilisez le filtre d'entrée 200 Hz. Comparez les résultats de mesure aux limites de test indiquées ci-dessous. (Assurez-vous qu'une stabilisation correcte de la source est possible.)

Valeurs pour les multimètres numériques 34461A, 34465A et 34470A								
Entrée				Vérification rapide	Erreur par rapport à la valeur nominale			
Fonction	Courant [1]	Fréquence	Plage		24 heures	90 jours	1 an	2 ans
I CC	5 A	S/O	10 A		± 3,5 mA	± 7 mA		± 8,5 mA
I CC	10 A	S/O	10 A	Q	± 16 mA	± 23 mA		± 26 mA
I CA	10 A	5 kHz	10 A		± 24 mA (34465A/70A) ± 29 mA (34461A)	± 29 mA		

^[1] Si vous n'utilisez PAS le dispositif Fluke F5725 pour l'étalonnage, réduisez le courant à 2 A.

Vérification des mesures de capacité (test de vérification en option)

Cette procédure en option permet de vérifier la précision de capacité.

1. Assurez-vous d'avoir lu la section **Considérations relatives aux tests**.
2. Sélectionnez la fonction de mesure de capacité.
3. Connectez l'appareil étalon de capacité aux bornes d'entrée avant, puis sélectionnez les bornes d'entrée avant à l'aide du commutateur avant/arrière.
4. Sélectionnez chaque plage dans l'ordre indiqué ci-dessous. Saisissez l'entrée indiquée.
5. Comparez les résultats de mesure aux limites de test indiquées dans le tableau. (Assurez-vous de patienter jusqu'à la stabilisation complète de la source.)

Entrée		Erreur par rapport à la valeur nominale
Capacité	Plage	
1 μ F	1 μ F	$\pm 0,005 \mu$ F
1 μ F	10 μ F	$\pm 0,014 \mu$ F

Procédure de réglage de l'étalonnage

Vous avez besoin d'un câble d'entrée de test, d'un jeu de connecteurs et d'une entrée en court-circuit à faible sensibilité thermique, Keysight 34172B, pour régler l'instrument (voir la section **Connexions d'entrée**). Deux entrées en court-circuit sont recommandées pour les modèles 34461A/65A/70A.

- **Processus d'étalonnage - Présentation**
- **Procédures d'étalonnage des modèles 34460A et 34461A**
- **Procédures d'étalonnage des modèles 34465A et 34470A**

Procédures d'étalonnage

Cette section décrit les procédures de vérification et de réglage du fonctionnement de l'instrument (étalonnage).

REMARQUE

Il n'y a aucun étalonnage distinct pour Diode ou Continuité, car ces fonctions sont basées sur la mesure de résistance, qui est étalonnée. Par ailleurs, il n'existe aucun étalonnage pour le temps de porte car cette fonction est contrôlée par une logique interne. Il n'y a aucun étalonnage pour le gain de capacité, pour les modèles 34465A et 34470A, aucun étalonnage sur les plages I CC de 1, 10 et 100 μ A

Utilisez l'un des ensembles de procédures suivants en fonction du numéro de modèle du multimètre numérique :

- [Procédures d'étalonnage des modèles 34460A et 34461A](#)
- [Procédures d'étalonnage des modèles 34465A et 34470A](#)

Étalonnage électronique en boîtier fermé

L'instrument utilise une méthode d'étalonnage électronique en boîtier fermé ; aucun réglage mécanique interne n'est nécessaire. L'instrument calcule les facteurs de correction sur la base de signaux de référence que vous appliquez et les enregistre en mémoire non volatile. L'extinction de l'instrument ou la fonction ***RST** ou **SYSTem:PRESet** ne modifie pas ces données.

Services d'étalonnage Keysight Technologies

Keysight Technologies offre des services d'étalonnage à travers des systèmes d'étalonnage automatique qui permettent à Keysight d'assurer un étalonnage à des prix compétitifs. Pour obtenir les coordonnées de Keysight, reportez-vous à la section [Types de services disponibles](#).

Intervalle de réglage de l'étalonnage

L'instrument doit être étalonné à intervalles réguliers, qui varient selon la précision nécessaire à votre application. Pour la plupart des applications, un étalonnage annuel suffit. Les spécifications de précision sont garanties uniquement si l'étalonnage est effectué régulièrement. Keysight Technologies recommande de ne pas laisser passer plus de 2 ans entre deux étalonnages.

Étalonnage recommandé

Quelle que soit la fréquence d'étalonnage choisie, Keysight Technologies recommande d'effectuer un réétalonnage complet au terme de cette durée. Cela garantit que l'instrument conservera ses caractéristiques jusqu'à l'étalonnage suivant ainsi que sa stabilité à long terme. Les résultats mesurés pendant les tests de vérification du fonctionnement ne signifient pas que l'instrument restera dans ces limites, sauf si les étalonnages ont été effectués. Utilisez le nombre de points d'étalonnage pour vérifier que tous les réglages ont été effectués.

Temps nécessaire à l'étalonnage

L'instrument, et notamment la procédure d'étalonnage complète et les tests de vérification du fonctionnement, peuvent être automatiquement étalonnés à l'aide d'un ordinateur en moins de 30 minutes une fois l'instrument chauffé (voir la section Considérations relatives aux tests).

Procédures automatiques d'étalonnage

Les procédures d'étalonnage expliquent comment étalonner le panneau avant. Vous pouvez automatiser les procédures complètes de vérification et d'étalonnage décrites dans le présent manuel. Vous pouvez programmer les configurations de l'instrument spécifiées pour chaque test sur l'interface de commande à distance. Vous pouvez ensuite entrer les données vérifiées dans un programme de test et comparer les résultats aux valeurs limites de test correspondantes.

Pour effectuer un étalonnage, vous devez déverrouiller la sécurité de l'instrument. Pour de plus amples informations, reportez-vous à la section [Sécurité de l'étalonnage](#).

Pour de plus amples informations sur la programmation SCPI, reportez-vous à la section [Sous-système CALibration](#).

Connexions d'entrée

Pour garantir des connexions de test optimales avec le multimètre, utilisez une fiche de court-circuit d'étalonnage 34172B Keysight Technologies pour des mesures à faible décalage thermique et un connecteur de multimètre numérique 34171B configuré pour relier l'instrument à la sortie de l'appareil étalon. Des câbles à paire torsadée blindés en PTFE d'une longueur minimale sont recommandés pour relier l'appareil étalon au multimètre afin de réduire les erreurs de stabilisation et de bruit. Les bornes HI et HI Sense doivent former une paire torsadée. Les bornes LO et LO Sense doivent former une paire torsadée. Les blindages des câbles doivent être référencés à la terre. Cette configuration vise à optimiser les performances en termes de réduction de bruit et de temps de stabilisation pendant l'étalonnage.

Considérations relatives aux tests

Les signaux en courant alternatif présents sur les cordons d'entrée pendant un autotest peuvent engendrer des erreurs. Des cordons de test longs peuvent également se comporter comme une antenne en captant des signaux en courant alternatif.

Pour des performances optimales :

- Assurez-vous que la température ambiante lors de l'étalonnage (Tcal) est stable et comprise entre 18 et 28 °C. Idéalement, l'étalonnage doit être effectué à 23 °C ± 2 °C.
- Vérifiez que l'humidité relative ambiante est inférieure à 80 %.
- Prévoyez une période de préchauffage de 90 minutes (ou 180 minutes pour le 34470A) avec un tube court en cuivre connecté.
- Reliez les blindages des câbles d'entrée à la terre. Sauf mention contraire dans les procédures, reliez la borne LO de l'instrument étalon à la terre au niveau de cet instrument. Il est essentiel que la borne LO soit reliée à la terre en un seul endroit afin d'éviter la formation de boucles de masse.

L'instrument permettant de réaliser des mesures très précises, vous devez prendre des précautions particulières pour vous assurer que les appareils étalons et les procédures de test n'introduiront pas d'erreurs supplémentaires. Idéalement, les appareils étalons utilisés pour vérifier et régler l'instrument doivent être environ dix fois plus précis que la spécification d'erreur de chaque calibre à la pleine échelle de cet instrument.

Pour les mesures de résistance en 2 fils, retirez la résistance des fils en effectuant une mesure par rapport à une valeur de référence à l'aide des fils court-circuités ou d'une fiche de court-circuit 4 bornes à faible sensibilité thermique de précision. Pour l'étalonnage du décalage, une fiche de court-circuit 4 bornes et faible sensibilité thermique est nécessaire.

Équipement de test recommandé

L'équipement nécessaire aux tests de vérification du fonctionnement et à la procédure d'étalonnage est répertorié ci-dessous. Si l'instrument recommandé n'est pas disponible, vous pouvez le remplacer par un autre de précision équivalente.

Il est également possible d'utiliser le multimètre numérique 8½ chiffres Keysight 3458A pour mesurer des sources moins précises, mais néanmoins stables. La valeur de sortie mesurée à partir de la source peut être introduite dans l'instrument comme valeur d'étalonnage cible.

Application	Équipement recommandé
Étalonnage du zéro	Keysight 34172B
Tension continue	Fluke 5720A
Courant continu	Fluke 5720A
Résistance	Fluke 5720A
Tension alternative	Fluke 5720A
Courant alternatif	Fluke 5720A
Fréquence	Générateur de signaux arbitraires/fonctions Keysight série 33500B

Procédure de réglage de l'étalonnage

Application	Équipement recommandé
Courant élevé	Fluke 5725A
Capacité (en option)	Norme de capacité SCA-1uF

Procédure de réglage de l'étalonnage

La procédure générale suivante est recommandée pour réaliser un étalonnage complet.

1. Reportez-vous à la section **Considérations relatives aux tests**.
2. Effectuez les **tests de vérification du fonctionnement** pour caractériser l'instrument (données entrantes).
3. Déverrouillez la sécurité de l'instrument pour l'étalonnage (voir la section **Sécurité de l'étalonnage**).
4. Effectuez les procédures d'étalonnage (voir la section **Procédures d'étalonnage**).
5. Verrouillez la sécurité d'étalonnage de l'instrument (voir la section **Sécurité de l'étalonnage**).
6. Notez le code de sécurité et le nombre de points d'étalonnage indiqués dans le dossier de maintenance de l'instrument.
7. Effectuez les **tests de vérification du fonctionnement** pour vérifier l'étalonnage.

Présentation du réglage de l'étalonnage de gain

La procédure de réglage de l'étalonnage du CAN et du zéro doit avoir été effectuée récemment avant de lancer l'étalonnage du gain. Les étalonnages de gain peuvent être effectués à l'aide des bornes d'entrée avant ou arrière (non disponibles sur le modèle 34461A). Sur les modèles 34461A/65A/70A, assurez-vous que le commutateur **avant/arrière** correspond aux bornes utilisées.

MISE EN GARDE Ne mettez jamais l'instrument hors tension pendant un étalonnage du gain ou de la planéité, sous peine de provoquer une perte de la mémoire d'étalonnage pour la fonction en cours.

Valeurs d'entrée d'étalonnage de gain et de planéité valides

L'étalonnage du gain peut être effectué à l'aide des valeurs d'entrée suivantes :

Fonction	Plage	Valeurs d'entrée d'amplitude valides
Tension continue	100 mV à 100 V	0,9 à 1,1 x pleine échelle
	1 000 V	450 à 1 000 V
Courant continu	100 µA à 1 A	0,9 à 1,1 x pleine échelle
	3 A	1,5 A à 2,5 A
	10 A	1,8 A à 10 A
Résistance (2 et 4 fils)	100 à 100 MΩ	0,9 à 1,1 x pleine échelle
Fréquence	Automatique	Entrée > 100 mV eff., 9,9 à 110 kHz
Courant alternatif (valeur efficace vraie) ^[1]	100 µA à 1 A	0,9 à 1,1 x pleine échelle
	3 A	0,9 A à 2 A
	10 A	2 A à 10 A
Tension alternative (valeur efficace vraie) ^[1]	100 mV à 10 V	0,9 à 1,1 x pleine échelle
	100 V	40 V à 110 V
	750 V	400 à 750 V

^[1] Les fréquences valides sont des fréquences nominales ±1 %.

Présentation du réglage de l'étalonnage de gain et de la planéité

L'instrument enregistre de nouvelles constantes de correction de planéité chaque fois que cette procédure est suivie. Les constantes de planéité règlent le multimètre numérique pour les mesures en courant et tension alternatifs sur la bande de fréquence d'entrée utilisable. La constante de planéité est calculée à partir de la valeur d'étalonnage saisie pour la commande d'étalonnage et des mesures effectuées automatiquement pendant la procédure d'étalonnage.

Les étalonnages pour chaque plage et fréquence doivent être réalisés dans l'ordre indiqué.

Considérations relatives à l'étalonnage de la planéité

La procédure de réglage de l'étalonnage du CAN et du zéro doit avoir été effectuée récemment avant de lancer l'étalonnage du gain. Les étalonnages de la planéité peuvent être effectués à l'aide des bornes d'entrée avant ou arrière. Sur les modèles 34461A/65A/70A, assurez-vous que le commutateur **avant/arrière** correspond aux bornes utilisées.

MISE EN GARDE Ne mettez jamais l'instrument hors tension pendant un étalonnage du gain ou de la planéité, sous peine de provoquer une perte de la mémoire d'étalonnage pour la fonction en cours.

Étalonnage du gain

L'instrument calcule et enregistre les corrections de gain pour chaque valeur d'entrée. La constante de planéité est calculée à partir de la valeur d'étalonnage saisie pour la commande d'étalonnage et des mesures effectuées automatiquement pendant la procédure d'étalonnage.

Des procédures d'étalonnage du gain sont définies pour la plupart des fonctions et des plages de mesure, et les étalonnages de chaque fonction doivent être effectués dans l'ordre indiqué.

Saisie des valeurs d'étalonnage et enregistrement des constantes d'étalonnage

Sélection du mode d'étalonnage

Utilisez la requête CALibration:ADC? pour lancer l'étalonnage du CAN. La réponse à cette requête indique un réglage réussi (0) ou un échec (1). Une fois l'étalonnage du CAN terminé, utilisez les commandes de mesure pour définir les paramètres et les fonctions de mesure du multimètre numérique pour le mode étalonné.

Panneau avant : [Utility] > Test/Admin > Calibrate > Perform Cal > Cal Value > Perform ADC Cal

Saisie des valeurs d'étalonnage

Pour saisir une valeur d'étalonnage à partir de l'interface de commande à distance, utilisez la commande CALibration:VALue <valeur>, suivie de la requête CALibration?. La réponse à la requête indique si l'étalonnage est valide.

Panneau avant : [Utility] > Test/Admin > Calibrate > Perform Cal > Cal Value > (enter value) > Perform Cal Step

Enregistrement des constantes d'étalonnage

Pour enregistrer des valeurs d'étalonnage dans la mémoire non volatile, utilisez la commande CALibration:STORE.

Panneau avant : [Utility] > Test/Admin > Calibrate > Save Cal Values

REMARQUE Vous devez avoir réussi un étalonnage immédiatement avant d'appuyer sur **Save Cal Values**.

Sécurité de l'étalonnage

Cette section décrit le système de sécurité de l'étalonnage de l'instrument. En cas d'oubli du code de sécurité, vous pouvez **remplacer la sécurité d'étalonnage**.

Sécurité - Présentation

Un code de sécurité empêche des réglages accidentels ou non autorisés de l'instrument.

- À la livraison de l'usine, l'instrument est verrouillé par le code de sécurité défini sur **AT3446XA**.
- Le même code de sécurité doit être utilisé pour une utilisation du panneau avant et à distance. Si vous verrouillez l'instrument sur le panneau avant, utilisez ce même code pour le déverrouiller à partir de l'interface de commande à distance.
- Ce paramètre est non volatile ; il n'est pas altéré par une remise sous tension ou l'exécution de la commande ***RST** ou **SYSTem:PRESet**.
- Règles applicables au code de sécurité :
 - Chaîne sans guillemets contenant jusqu'à 12 caractères
 - Doit commencer par une lettre (A-Z)
 - Peut contenir des lettres, des chiffres (0 à 9) et des traits de soulignement
- **Panneau avant** : [Utility] > Test / Admin > Security
- **SCPI** : **CALibration:SECure:STATe**

Message d'étalonnage

Vous pouvez enregistrer un message de 40 caractères maximum dans la mémoire d'étalonnage. Par exemple, vous pouvez enregistrer la date du dernier étalonnage, la date à laquelle l'étalonnage suivant doit être effectué, ou le nom et le numéro de téléphone de la personne responsable de l'étalonnage.

Pour lire le message d'étalonnage, appuyez sur **Utility > Test/Admin > Calibrate** ou envoyez la commande **CALibration:STRing?** depuis l'interface de commande à distance.

Pour modifier le message d'étalonnage, déverrouillez la sécurité de l'instrument, puis appuyez sur **Utility > Test/Admin > Calibrate > Edit Cal String** ou envoyez la commande **CALibration:STRing "<chaîne>"** depuis l'interface de commande à distance.

Nombre de points d'étalonnage

Vous pouvez interroger l'instrument afin de déterminer le nombre d'étalonnages effectués. Étant donné que cette valeur augmente chaque fois que vous enregistrez les constantes d'étalonnage, un étalonnage complet l'augmente considérablement. Le nombre de points d'étalonnage augmente également chaque fois que vous enregistrez une chaîne d'étalonnage, modifiez le mot de passe d'étalonnage ou remplacez le code de sécurité d'étalonnage.

Votre instrument a été étalonné en usine. À la réception de l'instrument, assurez-vous de lire le nombre de points d'étalonnage afin de déterminer sa valeur initiale.

Pour lire le nombre de points d'étalonnage, appuyez sur les touches **[Utility] > Test/Admin > Calibrate** du panneau avant ou envoyez la commande **CALibration:COUNT?** depuis l'interface de commande à distance. Vous pouvez lire le nombre de points d'étalonnage, que la sécurité de l'instrument ait été ou non verrouillée.

Interruption d'un étalonnage en cours

Il est parfois nécessaire d'interrompre un étalonnage. Vous pouvez interrompre à tout moment un étalonnage sur n'importe quel module en mettant l'instrument hors tension ou en affichant un message Device Clear sur l'interface de commande à distance.

MISE EN GARDE

Si vous interrompez un étalonnage en cours alors que l'instrument essaie d'écrire de nouvelles constantes d'étalonnage dans la mémoire EEPROM, vous risquez de perdre toutes les constantes d'étalonnage de la fonction. Généralement, lorsque vous rétablissez l'alimentation, l'instrument signale l'erreur 705 Cal:Aborted. Il peut également générer les erreurs 740 à 742. Si cela se produit, évitez d'utiliser l'instrument tant qu'un nouveau réglage complet n'a pas été effectué. Pour de plus amples informations, reportez-vous à la [liste des erreurs d'étalonnage](#).

Remplacement du code de sécurité

Le code de sécurité de l'instrument est réglé sur AT3446XA en usine. S'il a été modifié et si vous ne vous en souvenez plus, vous pouvez rétablir sa valeur par défaut en suivant l'une des deux procédures ci-dessous.

Quelle procédure dois-je suivre ?

Sur le panneau avant de l'instrument, appuyez sur **[Shift]** > **[Help]** > **About** pour afficher la version du microprogramme de l'instrument. Voici un exemple d'affichage :

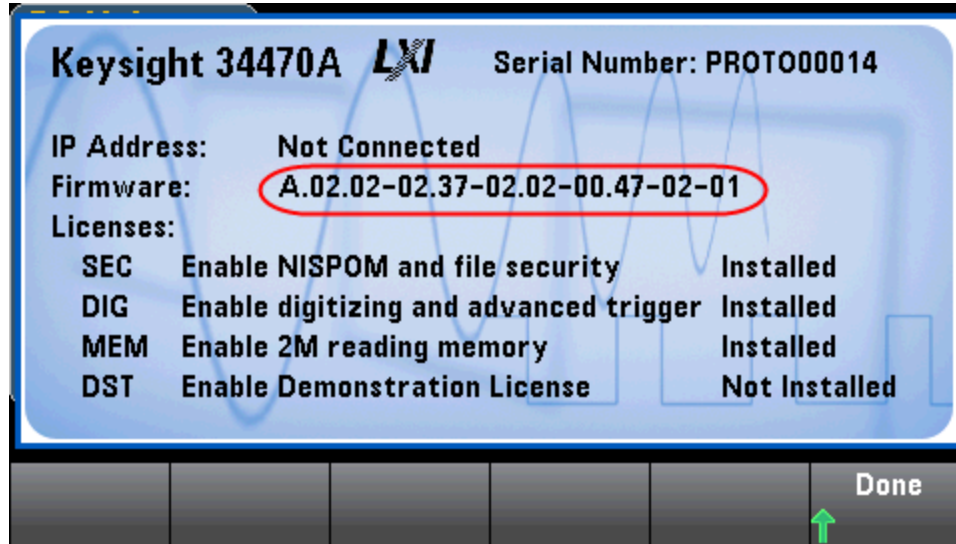

Les deux derniers chiffres de la révision du microprogramme indiquent la révision de la carte PC du panneau avant et l'une des deux procédures à suivre. Si la révision du microprogramme se termine par 02 ou supérieur, suivez la **procédure A**. Si elle se termine par 01, suivez la **procédure B**.



En cas de problème, contactez Keysight Technologies pour obtenir une assistance technique.

Aux États-Unis : (800) 829-4444

En Europe : 31 20 547 2111

Au Japon : 0120-421-345

Pour contacter Keysight dans le monde entier ou votre représentant Keysight Technologies, rendez-vous sur www.keysight.com/find/assist.

Procédure A : pour les révisions de microprogramme se terminant par 02 ou supérieur

AVERTISSEMENT

Cette procédure ne doit être effectuée que par des techniciens de maintenance qualifiés. Mettez l'instrument hors tension et débranchez tous les cordons de mesure et autres câbles, notamment le cordon d'alimentation, avant de poursuivre.

1. Suivez la **procédure de démontage** pour démonter l'instrument.
2. Recherchez le connecteur J102 sur la carte du panneau avant. Court-circuitez les broches A1 à B1, comme indiqué par la ligne orange ci-dessous.

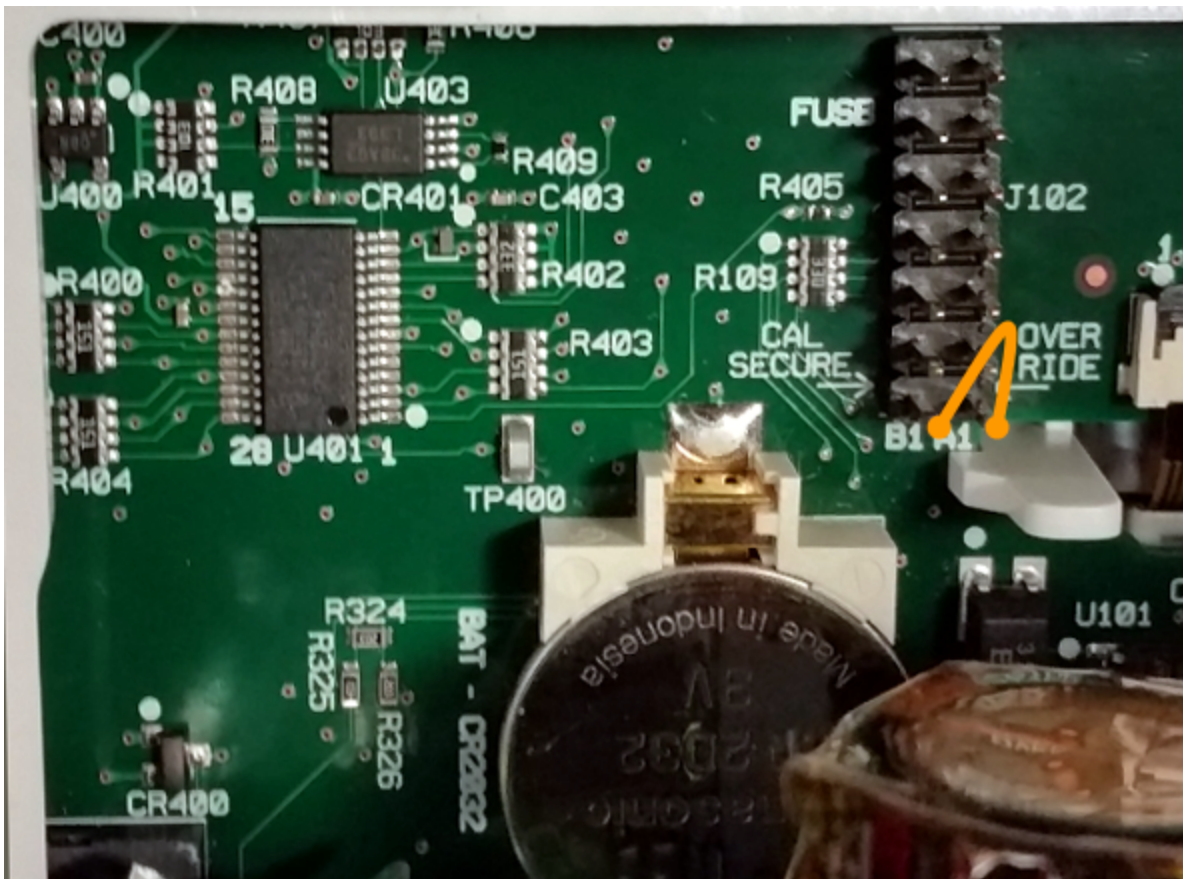

3. Remontez l'instrument, branchez-le et allumez-le ; l'instrument génère une erreur et émet un signal sonore (cela est normal). Patientez 30 à 40 secondes jusqu'à son initialisation complète.
4. Rétablissez les réglages d'usine par défaut du code de sécurité :
 - a. Appuyez sur **[Shift]** > **[Utility]** > **Test / Admin** > **Security** > **New Code**.
 - b. Saisissez le nouveau code d'accès AT3446XA.
 - c. Appuyez sur **Done**.
 - d. Vérifiez le nouveau code et appuyez sur **Yes** pour valider la modification.

5. Mettez l'instrument hors tension, démontez-le et retirez la fiche de court-circuit. Remontez ensuite l'instrument pour terminer la procédure de réinitialisation du code de sécurité.

Procédure B : pour les révisions de microprogramme se terminant par 01

AVERTISSEMENT

Cette procédure ne doit être effectuée que par des techniciens de maintenance qualifiés. Mettez l'instrument hors tension et débranchez tous les cordons de mesure et autres câbles, notamment le cordon d'alimentation, avant de poursuivre.

1. Suivez la **procédure de démontage** pour démonter l'instrument.
2. Recherchez le connecteur J102 sur la carte du panneau avant. Court-circuitez les broches A1 à A6 ou A7, comme indiqué par les lignes orange ci-dessous. Il n'est pas nécessaire de court-circuiter les deux broches sur A1 ; une seule broche suffit.

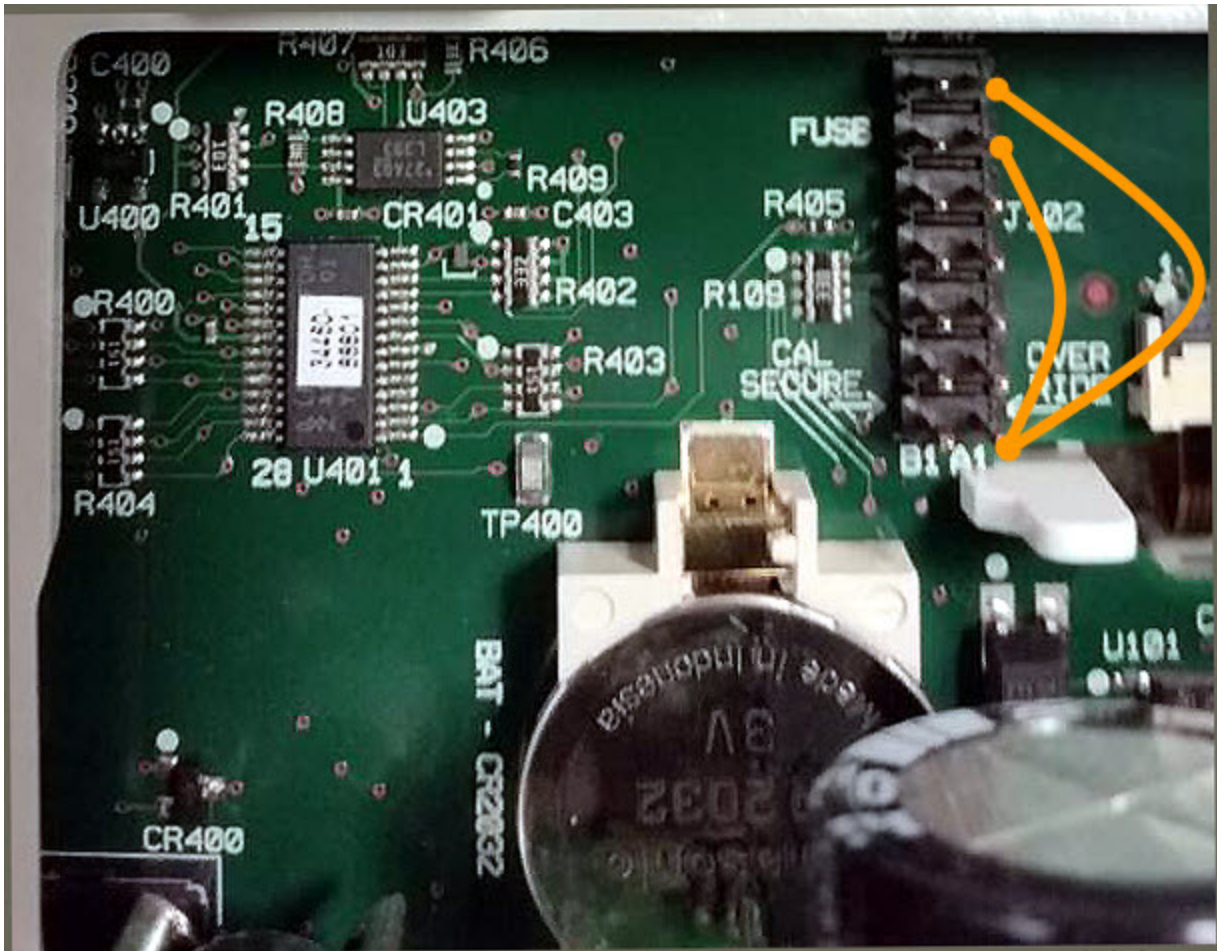

3. Remontez l'instrument, branchez-le et allumez-le ; l'instrument génère une erreur et émet un signal sonore (cela est normal). Patientez 30 à 40 secondes jusqu'à son initialisation complète.

4. Rétablissez les réglages d'usine par défaut du code de sécurité :
 - a. Appuyez sur **[Shift] > [Utility] > Test / Admin > Security > New Code**.
 - b. Saisissez le nouveau code d'accès AT3446XA.
 - c. Appuyez sur **Done**.
 - d. Vérifiez le nouveau code et appuyez sur **Yes** pour valider la modification.
5. Mettez l'instrument hors tension, démontez-le et retirez la fiche de court-circuit. Remontez ensuite l'instrument pour terminer la procédure de réinitialisation du code de sécurité.

Procédures d'étalonnage des multimètres 34460A et 34461A

Les procédures d'étalonnage suivantes concernent uniquement les multimètres numériques 34460A et 34461A. Exécutez les procédures d'étalonnage dans l'ordre indiqué dans ce document. Utilisez les liens fléchés au bas de chaque page pour passer à la procédure d'étalonnage suivante.

1. [Procédure d'étalonnage du CAN et du zéro](#)
2. [Étalonnage du gain et de la planéité à basse fréquence en tension alternative](#)
3. [Étalonnage du gain et de la planéité en tension alternative](#)
4. [Étalonnage du gain et de la planéité en courant alternatif](#)
5. [Étalonnage du zéro en CA](#)
6. [Étalonnage de la précision de fréquence](#)
7. [Étalonnage du gain en tension continue](#)
8. [Étalonnage du gain de résistance](#)
9. [Étalonnage du gain en courant continu](#)
10. [Étalonnage du gain 10 A en courant alternatif](#)
11. [Étalonnage du gain 10 A en courant continu](#)
12. [Étalonnage du décalage de capacité \(en option\)](#)
13. [Finalisation de l'étalonnage](#)

Première procédure 

Étalonnage du CAN et du zéro

Chaque fois que vous effectuez un réglage du zéro, l'instrument enregistre un nouveau jeu de constantes de correction de décalage pour chaque fonction et plage de mesure. L'instrument parcourt automatiquement toutes les fonctions et plages requises, et enregistre de nouvelles constantes d'étalonnage de décalage du zéro. Toutes les corrections de décalage sont déterminées automatiquement. Il n'est pas possible de corriger une seule plage ou fonction sans saisir à nouveau automatiquement TOUTES les constantes de correction de décalage du zéro. Cette fonction a pour but de réduire le temps d'étalonnage et d'améliorer la cohérence de l'étalonnage du zéro.

MISE EN GARDE Ne mettez jamais l'instrument hors tension pendant un étalonnage du zéro. Vous risqueriez de perdre TOUTE la mémoire d'étalonnage.

Procédure d'étalonnage du CAN et du zéro

Cette procédure d'étalonnage concerne tous les modèles (34460A/61A/65A/70A).

Assurez-vous de laisser l'instrument préchauffer et se stabiliser pendant 90 minutes (ou 180 minutes pour le 34470A) avant d'effectuer l'étalonnage.

1. Suivez les étapes décrites ci-dessous. Examinez la section **Considérations relatives aux tests** avant de commencer ce test.
2. Cette procédure utilise un bloc de court-circuitage à faible sensibilité thermique installé sur les connecteurs d'entrée.

REMARQUE Pour les modèles 34461A/65A/70A, l'utilisation de deux blocs de court-circuitage est recommandée : l'un sur le panneau avant et l'autre sur le panneau arrière. Un seul bloc de court-circuitage peut être utilisé avec le modèle 34460A.

3. Sélectionnez les bornes d'entrée du panneau avant. Installez la fiche de court-circuit d'étalonnage sur les bornes d'entrée du panneau avant.
4. Sélectionnez le mode d'étalonnage du CAN ([Utility] > Test/Admin > Calibrate > Perform Cal > Perform ADC Cal).
5. L'écran affiche un message indiquant que l'étalonnage du CAN est en cours. Il présente ensuite les résultats de l'étalonnage du CAN. Le message Calibration Step Succeeded (Étape d'étalonnage réussie) indique une réussite ; si l'écran affiche le message Calibration Step Failed (Échec de l'étape d'étalonnage), vérifiez la valeur du signal d'entrée, la plage, la fonction et la valeur d'étalonnage saisie, puis recommencez l'étape d'étalonnage. Appuyez sur **Save Cal Values**.
6. Sélectionnez la fonction de mesure en courant continu. Saisissez la valeur d'étalonnage +0.
7. Appuyez sur [Utility] > Test/Admin > Calibrate > Perform Cal > Perform Cal Step.
8. La procédure d'étalonnage du zéro dure environ deux minutes. Le message Calibration Step Succeeded (Étape d'étalonnage réussie) indique une réussite ; si l'écran affiche le message Calibration Step Failed (Échec de l'étape d'étalonnage), vérifiez la valeur du signal d'entrée, la plage, la fonction et la valeur d'étalonnage saisie, puis recommencez l'étape d'étalonnage.
9. Appuyez sur **Save Cal Values**.

Procédure de réglage de l'étalonnage

10. Sélectionnez les bornes d'entrée arrière. Installez la fiche de court-circuit d'étalonnage sur les bornes d'entrée du panneau arrière.
11. Répétez les étapes 4 à 9 pour les bornes d'entrée arrière.
12. Enregistrez les nouvelles constantes d'étalonnage du CAN et du zéro (voir la section Enregistrement des constantes d'étalonnage).

REMARQUE Les étalonnages de gain et de la planéité peuvent être effectués à l'aide des bornes d'entrée avant ou arrière (les bornes arrière ne sont pas disponibles sur le modèle 34460A). Sur les modèles 34461A/65A/70A, assurez-vous que le commutateur **avant/arrière** correspond aux bornes utilisées.

Procédure suivante

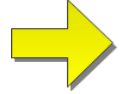

Étalonnage du gain et de la planéité à basse fréquence en tension alternative

Cette procédure d'étalonnage concerne tous les modèles (34460A/61A/65A/70A).

Avant d'effectuer cet étalonnage, reportez-vous aux sections **Considérations relatives aux tests** et **Considérations relatives à l'étalonnage de la planéité**.

Configuration : Tension alternative

1. Configurez la plage indiquée dans le tableau ci-dessous.
2. Appliquez le signal d'entrée indiqué dans la colonne Entrée.
3. **Saisissez l'amplitude de tension d'entrée réelle appliquée** (voir la section **Saisie des valeurs d'étalonnage**). Le message Calibration Step Succeeded (Étape d'étalonnage réussie) indique une réussite ; si l'écran affiche le message Calibration Step Failed (Échec de l'étape d'étalonnage), vérifiez la valeur du signal d'entrée, la plage, la fonction et la valeur d'étalonnage saisie, puis recommencez l'étape d'étalonnage.
4. Répétez les étapes 1 à 3 pour chaque point d'étalonnage de planéité indiqué dans le tableau.
5. Enregistrez les nouvelles constantes d'étalonnage (voir la section **Enregistrement des constantes d'étalonnage**).

REMARQUE Chaque mesure de tension et fréquence prend environ 2,5 secondes.

Entrée		Instrument
V eff	Fréquence	Plage
7 V	10 Hz	10 V
7 V	40 Hz	10 V

Procédure suivante

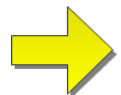

Étalonnage du gain et de la planéité en tension alternative

Cette procédure d'étalonnage concerne tous les modèles (34460A/61A/65A/70A).

Avant d'effectuer cet étalonnage, reportez-vous aux sections **Considérations relatives aux tests** et **Considérations relatives à l'étalonnage de la planéité**.

Configuration : Tension alternative

Toutes les procédures d'étalonnage en courant alternatif utilisent le filtre de mesure de bande passante 3 Hz.

1. Configurez chaque fonction et plage dans l'ordre indiqué dans le tableau ci-dessous.
2. Appliquez le signal d'entrée indiqué dans la colonne Entrée.
3. **Saisissez l'amplitude de tension d'entrée réelle appliquée** (voir la section **Saisie des valeurs d'étalonnage**). Le message Calibration Step Succeeded (Étape d'étalonnage réussie) indique une réussite ; si l'écran affiche le message Calibration Step Failed (Échec de l'étape d'étalonnage), vérifiez la valeur du signal d'entrée, la plage, la fonction et la valeur d'étalonnage saisie, puis recommencez l'étape d'étalonnage.
4. Répétez les étapes 1 à 3 pour chaque point d'étalonnage de planéité indiqué dans le tableau.
5. Enregistrez les nouvelles constantes d'étalonnage (voir la section **Enregistrement des constantes d'étalonnage**).

REMARQUE Chaque mesure de tension et fréquence prend environ 2,5 secondes.

Entrée		Instrument
V eff	Fréquence	Plage
100 mV	5 kHz, 10 kHz, 20 kHz, 35 kHz, 50 kHz, 75 kHz, 100 kHz, 200 kHz, 300 kHz, 390 kHz, 400 kHz, 220 Hz, 1 000 Hz	100 mV
1 V	5 kHz, 10 kHz, 20 kHz, 35 kHz, 50 kHz, 75 kHz, 100 kHz, 200 kHz, 300 kHz, 390 kHz, 400 kHz, 220 Hz, 1 000 Hz	1 V
10 V	5 kHz, 10 kHz, 20 kHz, 35 kHz, 50 kHz, 75 kHz, 100 kHz, 200 kHz, 300 kHz, 390 kHz, 400 kHz, 220 Hz, 1 000 Hz	10 V
50 V	5 kHz, 10 kHz, 20 kHz, 35 kHz, 50 kHz, 75 kHz, 100 kHz, 200 kHz, 300 kHz, 390 kHz, 400 kHz, 220 Hz, 1 000 Hz	100 V
500 V	1 000 Hz	750 V

Procédure suivante



Étalonnage du gain et de la planéité en courant alternatif

Cette procédure d'étalonnage concerne uniquement les modèles 34460A et 34461A.

Avant d'effectuer cet étalonnage, reportez-vous aux sections **Considérations relatives aux tests** et **Considérations relatives à l'étalonnage de la planéité**.

Configuration : Courant alternatif

Toutes les procédures d'étalonnage en courant alternatif utilisent le filtre de mesure de bande passante 3 Hz.

1. Sélectionnez chaque plage dans l'ordre indiqué dans le tableau ci-dessous.
2. Appliquez chaque courant et fréquence d'entrée indiqué dans les colonnes Entrée.
3. Saisissez le courant d'entrée réel appliqué comme valeur d'étalonnage (voir la section **Saisie des valeurs d'étalonnage**). Le message Calibration Step Succeeded (Étape d'étalonnage réussie) indique une réussite ; si l'écran affiche le message Calibration Step Failed (Échec de l'étape d'étalonnage), vérifiez la valeur du signal d'entrée, la plage, la fonction et la valeur d'étalonnage saisie, puis recommencez l'étape d'étalonnage.
4. Répétez les étapes 1 à 3 pour chaque fréquence indiquée dans le tableau.
5. Répétez les étapes 1 à 4 pour chaque plage indiquée dans le tableau.
6. Enregistrez les nouvelles constantes d'étalonnage (voir la section **Enregistrement des constantes d'étalonnage**).

REMARQUE Chaque mesure de courant et de fréquence prend environ 2,5 secondes.

Entrée		Instrument
Courant	Fréquence	Plage
1 A	5 kHz, 7,5 kHz, 9,7 kHz, 10 kHz, 220 Hz, 1 kHz	1 A
100 mA	5 kHz, 7,5 kHz, 9,7 kHz, 10 kHz, 220 Hz, 1 kHz	100 mA
10 mA	5 kHz, 7,5 kHz, 9,7 kHz, 10 kHz, 220 Hz, 1 kHz	10 mA
1 mA	1 kHz	1 mA
100 µA	1 kHz	100 µA

Procédure suivante

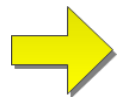

Étalonnage du zéro en CA

Cette procédure d'étalonnage concerne tous les modèles (34460A/61A/65A/70A).

Reportez-vous à la section **Considérations relatives aux tests** avant d'effectuer une procédure d'étalonnage.

Configuration : Tension alternative

1. Réglez l'appareil étalon sur 0,00 Vca.
2. Saisissez une valeur d'étalonnage de +0. (voir la section **Saisie des valeurs d'étalonnage**). Le message Calibration Step Succeeded (Étape d'étalonnage réussie) indique une réussite ; si l'écran affiche le message Calibration Step Failed (Échec de l'étape d'étalonnage), vérifiez la valeur du signal d'entrée, la plage, la fonction et la valeur d'étalonnage saisie, puis recommencez l'étape d'étalonnage.
3. Enregistrez les nouvelles constantes d'étalonnage (voir la section **Enregistrement des constantes d'étalonnage**).

REMARQUE Cette procédure d'étalonnage prend environ 10 secondes.

Procédure suivante 

Étalonnage de la précision de fréquence

Cette procédure d'étalonnage concerne tous les modèles (34460A/61A/65A/70A).

Avant de commencer cette procédure, consultez les sections [Considérations relatives aux tests](#) et [Considérations relatives à l'étalonnage du gain](#).

Configuration : Fréquence, plage de 10 V

REMARQUE La précision de fréquence de l'instrument Fluke 5720A est insuffisante pour étalonner le multimètre numérique. Sa sortie de fréquence doit être étalonnée par rapport à une référence plus précise. Le générateur de fonctions/signaux arbitraires Keysight série 33500B est recommandé pour cette procédure d'étalonnage.

1. Configurez l'instrument pour des mesures de fréquence à 10 V et 10 kHz, avec un temps de porte de 1 seconde.
2. Appliquez une onde sinusoïdale de 10 kHz, amplitude 20 Vpp.
3. Saisissez la fréquence d'entrée appliquée réelle (voir la section [Saisie des valeurs d'étalonnage](#)). Le message Calibration Step Succeeded (Étape d'étalonnage réussie) indique une réussite ; si l'écran affiche le message Calibration Step Failed (Échec de l'étape d'étalonnage), vérifiez la valeur du signal d'entrée, la plage, la fonction et la valeur d'étalonnage saisie, puis recommencez l'étape d'étalonnage.
4. Enregistrez les nouvelles constantes d'étalonnage (voir la section [Enregistrement des constantes d'étalonnage](#)).

REMARQUE Cette procédure d'étalonnage prend environ 1 seconde.

Procédure suivante 

Étalonnage du gain en tension continue

Cette procédure d'étalonnage concerne uniquement les modèles 34460A et 34461A.

Avant de commencer cette procédure, consultez les sections **Considérations relatives aux tests** et **Considérations relatives à l'étalonnage du gain**.

Configuration : Tension continue

1. Configurez chaque fonction et plage dans l'ordre indiqué dans le tableau ci-dessous.
2. Appliquez le signal d'entrée indiqué dans la colonne Entrée.
3. **Saisissez l'amplitude de tension d'entrée réelle appliquée** (voir la section **Saisie des valeurs d'étalonnage**). Le message Calibration Step Succeeded (Étape d'étalonnage réussie) indique une réussite ; si l'écran affiche le message Calibration Step Failed (Échec de l'étape d'étalonnage), vérifiez la valeur du signal d'entrée, la plage, la fonction et la valeur d'étalonnage saisie, puis recommencez l'étape d'étalonnage.
4. Répétez les étapes 1 à 3 pour chaque point d'étalonnage de gain indiqué dans le tableau.
5. Enregistrez les nouvelles constantes d'étalonnage (voir la section **Enregistrement des constantes d'étalonnage**).

REMARQUE Chaque réglage de plage prend moins de 4 secondes.

Réglages de l'instrument		
Entrée	Fonction	Plage
10 V	Tension continue	10 V
-10 V		10 V
0,1 V		100 mV
-0,1 V		100 mV
1 V		1 V
100 V		100 V
500 V		1 000 V

Procédure suivante

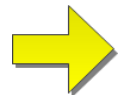

Étalonnage du gain de résistance

Cette procédure d'étalonnage concerne tous les modèles (34460A/61A/65A/70A).

Avant de commencer cette procédure, consultez les sections [Considérations relatives aux tests](#) et [Considérations relatives à l'étalonnage du gain](#).

Configuration : Résistance en 4 fils

Cette procédure permet de régler le gain pour les fonctions de résistance en 2 et 4 fils, et la fonction de résistance à compensation de décalage.

1. Configurez chaque fonction et plage dans l'ordre indiqué dans le tableau ci-dessous.
2. Appliquez le signal d'entrée indiqué dans la colonne Entrée.
3. Saisissez la valeur réelle de résistance d'entrée appliquée (voir la section [Saisie des valeurs d'étalonnage](#)). Le message Calibration Step Succeeded (Étape d'étalonnage réussie) indique une réussite ; si l'écran affiche le message Calibration Step Failed (Échec de l'étape d'étalonnage), vérifiez la valeur du signal d'entrée, la plage, la fonction et la valeur d'étalonnage saisie, puis recommencez l'étape d'étalonnage.
4. Répétez les étapes 1 à 3 pour chaque point d'étalonnage de gain indiqué dans le tableau.
5. Enregistrez les nouvelles constantes d'étalonnage (voir la section [Enregistrement des constantes d'étalonnage](#)).

REMARQUE Chaque réglage de plage prend moins de 4 secondes.

Réglages de l'instrument		
Entrée	Fonction	Plage
100 Ω	Résistance en 4 fils	100 Ω
1 k Ω		1 k Ω
10 k Ω		10 k Ω
100 k Ω		100 k Ω
1 M Ω		1 M Ω
10 M Ω		10 M Ω
100 M Ω	Résistance en 2 fils	100 M Ω

Procédure suivante

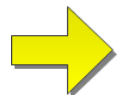

Étalonnage du gain en courant continu

Cette procédure d'étalonnage concerne uniquement les modèles 34460A et 34461A.

Avant de commencer cette procédure, consultez les sections **Considérations relatives aux tests** et **Considérations relatives à l'étalonnage du gain**.

Configuration : Courant continu

1. Configurez chaque fonction et plage dans l'ordre indiqué dans le tableau ci-dessous.
2. Appliquez le signal d'entrée indiqué dans la colonne Entrée.
3. Saisissez le courant d'entrée réel appliqué comme valeur d'étalonnage (voir la section **Saisie des valeurs d'étalonnage**). Le message Calibration Step Succeeded (Étape d'étalonnage réussie) indique une réussite ; si l'écran affiche le message Calibration Step Failed (Échec de l'étape d'étalonnage), vérifiez la valeur du signal d'entrée, la plage, la fonction et la valeur d'étalonnage saisie, puis recommencez l'étape d'étalonnage.
4. Répétez les étapes 1 à 3 pour chaque point d'étalonnage de gain indiqué dans le tableau.
5. Enregistrez les nouvelles constantes d'étalonnage (voir la section **Enregistrement des constantes d'étalonnage**).

REMARQUE Chaque réglage de plage prend moins de 4 secondes.

Réglages de l'instrument		
Entrée	Fonction	Plage
100 μ A	Courant continu	100 μ A
1 mA		1 mA
10 mA		10 mA
100 mA		100 mA
1 A		1 A

Procédure suivante 

Étalonnage du gain 10 A en courant alternatif

Cette procédure d'étalonnage concerne uniquement les modèles 34461A, 34465A et 34470A (et non le modèle 34460A).

Avant d'effectuer cet étalonnage, reportez-vous aux sections **Considérations relatives aux tests** et **Considérations relatives à l'étalonnage de la planéité**.

Configuration : Courant alternatif

Toutes les procédures d'étalonnage en courant alternatif utilisent le filtre de mesure de bande passante 3 Hz.

1. Sélectionnez la plage de 10 A.
2. Appliquez le signal d'entrée de 5 A à 1 000 Hz.
3. Saisissez le courant d'entrée réel appliqué comme valeur d'étalonnage (voir la section **Saisie des valeurs d'étalonnage**). Le message Calibration Step Succeeded (Étape d'étalonnage réussie) indique une réussite ; si l'écran affiche le message Calibration Step Failed (Échec de l'étape d'étalonnage), vérifiez la valeur du signal d'entrée, la plage, la fonction et la valeur d'étalonnage saisie, puis recommencez l'étape d'étalonnage.
4. Enregistrez les nouvelles constantes d'étalonnage (voir la section **Enregistrement des constantes d'étalonnage**).

REMARQUE Cette procédure d'étalonnage prend environ 2,5 secondes.

Procédure suivante 

Étalonnage du gain 10 A en courant continu

Cette procédure d'étalonnage concerne uniquement les modèles 34461A, 34465A et 34470A (et non le modèle 34460A).

Avant d'effectuer cet étalonnage, reportez-vous aux sections **Considérations relatives aux tests** et **Considérations relatives à l'étalonnage de la planéité**.

Configuration : Courant continu

1. Configurez la plage de 10 A et définissez le temps d'intégration sur 100 PLC.
2. Appliquez l'entrée de 5 A.
3. Saisissez le courant d'entrée réel appliqué comme valeur d'étalonnage (voir la section **Saisie des valeurs d'étalonnage**). Le message Calibration Step Succeeded (Étape d'étalonnage réussie) indique une réussite ; si l'écran affiche le message Calibration Step Failed (Échec de l'étape d'étalonnage), vérifiez la valeur du signal d'entrée, la plage, la fonction et la valeur d'étalonnage saisie, puis recommencez l'étape d'étalonnage.
4. Enregistrez les nouvelles constantes d'étalonnage (voir la section **Enregistrement des constantes d'étalonnage**).

REMARQUE Cette procédure d'étalonnage prend moins de 4 secondes.

Procédure suivante

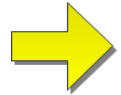

Étalonnage du décalage de capacité (en option)

Cette procédure d'étalonnage concerne tous les modèles (34460A/61A/65A/70A).

Cet étalonnage n'est en principe pas nécessaire. Il compense le décalage de capacité résiduel qui est généralement inférieur à quelques pF. Dans des conditions d'utilisation normales, tout décalage résiduel est remplacé par la fonction de mesure par rapport à une référence (cette dernière corrige également la capacité du câble), qui est nécessaire pour répondre aux spécifications de capacité du multimètre numérique.

Configuration : Capacité

1. Débranchez tous les connecteurs des bornes avant de l'instrument.
2. Sélectionnez les bornes avant.
3. Saisissez une valeur d'étalonnage (voir la section **Saisie des valeurs d'étalonnage**). Le message Calibration Step Succeeded (Étape d'étalonnage réussie) indique une réussite ; si l'écran affiche le message Calibration Step Failed (Échec de l'étape d'étalonnage), vérifiez la valeur du signal d'entrée, la plage, la fonction et la valeur d'étalonnage saisie, puis recommencez l'étape d'étalonnage.
4. Répétez les étapes 1 à 3 pour les bornes arrière de l'instrument (note applicable au modèle 34460A).
5. Enregistrez les nouvelles constantes d'étalonnage (voir la section **Enregistrement des constantes d'étalonnage**).

Procédure suivante

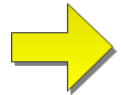

Finalisation de l'étalonnage

Pour finaliser l'étalonnage de votre instrument, procédez comme suit :

1. Déconnectez tous les blocs et connexions de court-circuitage de l'instrument.
2. Réinitialisez le **message d'étalonnage**.
3. **Verrouillez la sécurité de l'instrument** à l'aide du mot de passe d'étalonnage.
4. Enregistrez le **nouveau nombre de points d'étalonnage**.
5. Effectuez les **tests de vérification du fonctionnement** pour vérifier l'étalonnage.

Procédures d'étalonnage des multimètres 34465A et 34470A

Les procédures d'étalonnage suivantes concernent uniquement les multimètres numériques 34465A et 34470A. Exécutez les procédures d'étalonnage dans l'ordre indiqué dans ce document. Utilisez les liens fléchés au bas de chaque page pour passer à la procédure d'étalonnage suivante.

1. [Étalonnage du CAN et du zéro](#)
2. [Étalonnage du gain et de la planéité à basse fréquence en tension alternative](#)
3. [Étalonnage du gain et de la planéité en tension alternative](#)
4. [Étalonnage du gain et de la planéité en courant alternatif](#)
5. [Étalonnage du zéro en CA](#)
6. [Étalonnage de la précision de fréquence](#)
7. [Étalonnage du gain en tension continue](#)
8. [Étalonnage du gain de résistance](#)
9. [Étalonnage du gain en courant continu](#)
10. [Étalonnage du gain 10 A en courant alternatif](#)
11. [Étalonnage du gain 10 A en courant continu](#)
12. [Étalonnage du gain en tension continue](#)
13. [Étalonnage du décalage de capacité \(en option\)](#)
14. [Finalisation de l'étalonnage](#)

Première procédure

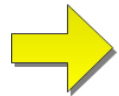

Étalonnage du CAN et du zéro

Chaque fois que vous effectuez un réglage du zéro, l'instrument enregistre un nouveau jeu de constantes de correction de décalage pour chaque fonction et plage de mesure. L'instrument parcourt automatiquement toutes les fonctions et plages requises, et enregistre de nouvelles constantes d'étalonnage de décalage du zéro. Toutes les corrections de décalage sont déterminées automatiquement. Il n'est pas possible de corriger une seule plage ou fonction sans saisir à nouveau automatiquement TOUTES les constantes de correction de décalage du zéro. Cette fonction a pour but de réduire le temps d'étalonnage et d'améliorer la cohérence de l'étalonnage du zéro.

MISE EN GARDE Ne mettez jamais l'instrument hors tension pendant un étalonnage du zéro. Vous risqueriez de perdre TOUTE la mémoire d'étalonnage.

Procédure d'étalonnage du CAN et du zéro

Cette procédure d'étalonnage concerne tous les modèles (34460A/61A/65A/70A).

Assurez-vous de laisser l'instrument préchauffer et se stabiliser pendant 90 minutes (ou 180 minutes pour le 34470A) avant d'effectuer l'étalonnage.

1. Suivez les étapes décrites ci-dessous. Examinez la section **Considérations relatives aux tests** avant de commencer ce test.
2. Cette procédure utilise un bloc de court-circuitage à faible sensibilité thermique installé sur les connecteurs d'entrée.

REMARQUE Pour les modèles 34461A/65A/70A, l'utilisation de deux blocs de court-circuitage est recommandée : l'un sur le panneau avant et l'autre sur le panneau arrière. Un seul bloc de court-circuitage peut être utilisé avec le modèle 34460A.

3. Sélectionnez les bornes d'entrée du panneau avant. Installez la fiche de court-circuit d'étalonnage sur les bornes d'entrée du panneau avant.
4. Sélectionnez le mode d'étalonnage du CAN ([Utility] > Test/Admin > Calibrate > Perform Cal > Perform ADC Cal).
5. L'écran affiche un message indiquant que l'étalonnage du CAN est en cours. Il présente ensuite les résultats de l'étalonnage du CAN. Le message Calibration Step Succeeded (Étape d'étalonnage réussie) indique une réussite ; si l'écran affiche le message Calibration Step Failed (Échec de l'étape d'étalonnage), vérifiez la valeur du signal d'entrée, la plage, la fonction et la valeur d'étalonnage saisie, puis recommencez l'étape d'étalonnage. Appuyez sur **Save Cal Values**.
6. Sélectionnez la fonction de mesure en courant continu. Saisissez la valeur d'étalonnage +0.
7. Appuyez sur [Utility] > Test/Admin > Calibrate > Perform Cal > Perform Cal Step.
8. La procédure d'étalonnage du zéro dure environ deux minutes. Le message Calibration Step Succeeded (Étape d'étalonnage réussie) indique une réussite ; si l'écran affiche le message Calibration Step Failed (Échec de l'étape d'étalonnage), vérifiez la valeur du signal d'entrée, la plage, la fonction et la valeur d'étalonnage saisie, puis recommencez l'étape d'étalonnage.
9. Appuyez sur **Save Cal Values**.

10. Sélectionnez les bornes d'entrée arrière. Installez la fiche de court-circuit d'étalonnage sur les bornes d'entrée du panneau arrière.
11. Répétez les étapes 4 à 9 pour les bornes d'entrée arrière.
12. Enregistrez les nouvelles constantes d'étalonnage du CAN et du zéro (voir la section Enregistrement des constantes d'étalonnage).

REMARQUE Les étalonnages de gain et de la planéité peuvent être effectués à l'aide des bornes d'entrée avant ou arrière (les bornes arrière ne sont pas disponibles sur le modèle 34460A). Sur les modèles 34461A/65A/70A, assurez-vous que le commutateur **avant/arrière** correspond aux bornes utilisées.

Procédure suivante

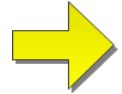

Étalonnage du gain et de la planéité à basse fréquence en tension alternative

Cette procédure d'étalonnage concerne tous les modèles (34460A/61A/65A/70A).

Avant d'effectuer cet étalonnage, reportez-vous aux sections **Considérations relatives aux tests** et **Considérations relatives à l'étalonnage de la planéité**.

Configuration : Tension alternative

1. Configurez la plage indiquée dans le tableau ci-dessous.
2. Appliquez le signal d'entrée indiqué dans la colonne Entrée.
3. **Saisissez l'amplitude de tension d'entrée réelle appliquée** (voir la section **Saisie des valeurs d'étalonnage**). Le message Calibration Step Succeeded (Étape d'étalonnage réussie) indique une réussite ; si l'écran affiche le message Calibration Step Failed (Échec de l'étape d'étalonnage), vérifiez la valeur du signal d'entrée, la plage, la fonction et la valeur d'étalonnage saisie, puis recommencez l'étape d'étalonnage.
4. Répétez les étapes 1 à 3 pour chaque point d'étalonnage de planéité indiqué dans le tableau.
5. Enregistrez les nouvelles constantes d'étalonnage (voir la section **Enregistrement des constantes d'étalonnage**).

REMARQUE Chaque mesure de tension et fréquence prend environ 2,5 secondes.

Entrée		Instrument
V eff	Fréquence	Plage
7 V	10 Hz	10 V
7 V	40 Hz	10 V

Procédure suivante

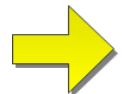

Étalonnage du gain et de la planéité en tension alternative

Cette procédure d'étalonnage concerne tous les modèles (34460A/61A/65A/70A).

Avant d'effectuer cet étalonnage, reportez-vous aux sections **Considérations relatives aux tests** et **Considérations relatives à l'étalonnage de la planéité**.

Configuration : Tension alternative

Toutes les procédures d'étalonnage en courant alternatif utilisent le filtre de mesure de bande passante 3 Hz.

1. Configurez chaque fonction et plage dans l'ordre indiqué dans le tableau ci-dessous.
2. Appliquez le signal d'entrée indiqué dans la colonne Entrée.
3. **Saisissez l'amplitude de tension d'entrée réelle appliquée** (voir la section **Saisie des valeurs d'étalonnage**). Le message Calibration Step Succeeded (Étape d'étalonnage réussie) indique une réussite ; si l'écran affiche le message Calibration Step Failed (Échec de l'étape d'étalonnage), vérifiez la valeur du signal d'entrée, la plage, la fonction et la valeur d'étalonnage saisie, puis recommencez l'étape d'étalonnage.
4. Répétez les étapes 1 à 3 pour chaque point d'étalonnage de planéité indiqué dans le tableau.
5. Enregistrez les nouvelles constantes d'étalonnage (voir la section **Enregistrement des constantes d'étalonnage**).

REMARQUE Chaque mesure de tension et fréquence prend environ 2,5 secondes.

Entrée		Instrument
V eff	Fréquence	Plage
100 mV	5 kHz, 10 kHz, 20 kHz, 35 kHz, 50 kHz, 75 kHz, 100 kHz, 200 kHz, 300 kHz, 390 kHz, 400 kHz, 220 Hz, 1 000 Hz	100 mV
1 V	5 kHz, 10 kHz, 20 kHz, 35 kHz, 50 kHz, 75 kHz, 100 kHz, 200 kHz, 300 kHz, 390 kHz, 400 kHz, 220 Hz, 1 000 Hz	1 V
10 V	5 kHz, 10 kHz, 20 kHz, 35 kHz, 50 kHz, 75 kHz, 100 kHz, 200 kHz, 300 kHz, 390 kHz, 400 kHz, 220 Hz, 1 000 Hz	10 V
50 V	5 kHz, 10 kHz, 20 kHz, 35 kHz, 50 kHz, 75 kHz, 100 kHz, 200 kHz, 300 kHz, 390 kHz, 400 kHz, 220 Hz, 1 000 Hz	100 V
500 V	1 000 Hz	750 V

Procédure suivante

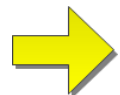

Étalonnage du gain et de la planéité en courant alternatif

Cette procédure d'étalonnage concerne uniquement les modèles 34465A et 34470A.

Avant d'effectuer cet étalonnage, reportez-vous aux sections **Considérations relatives aux tests** et **Considérations relatives à l'étalonnage de la planéité**.

Configuration : Courant alternatif

Toutes les procédures d'étalonnage en courant alternatif utilisent le filtre de mesure de bande passante 3 Hz.

1. Sélectionnez chaque plage dans l'ordre indiqué dans le tableau ci-dessous.
2. Appliquez chaque courant et fréquence d'entrée indiqué dans les colonnes Entrée.
3. Saisissez le courant d'entrée réel appliqué comme valeur d'étalonnage (voir la section **Saisie des valeurs d'étalonnage**). Le message Calibration Step Succeeded (Étape d'étalonnage réussie) indique une réussite ; si l'écran affiche le message Calibration Step Failed (Échec de l'étape d'étalonnage), vérifiez la valeur du signal d'entrée, la plage, la fonction et la valeur d'étalonnage saisie, puis recommencez l'étape d'étalonnage.
4. Répétez les étapes 1 à 3 pour chaque fréquence indiquée dans le tableau.
5. Répétez les étapes 1 à 4 pour chaque plage de courant indiquée dans le tableau.
6. Enregistrez les nouvelles constantes d'étalonnage (voir la section **Enregistrement des constantes d'étalonnage**).

REMARQUE Chaque mesure de courant et de fréquence prend environ 2,5 secondes.

Entrée		Instrument
Courant	Fréquence	Plage
1,5 A	5 kHz, 7,5 kHz, 9,7 kHz, 10 kHz, 220 Hz, 1 kHz	3 A
1 A	5 kHz, 7,5 kHz, 9,7 kHz, 10 kHz, 220 Hz, 1 kHz	1 A
100 mA	5 kHz, 7,5 kHz, 9,7 kHz, 10 kHz, 220 Hz, 1 kHz	100 mA
10 mA	5 kHz, 7,5 kHz, 9,7 kHz, 10 kHz, 220 Hz, 1 kHz	10 mA
1 mA	5 kHz, 7,5 kHz, 9,7 kHz, 10 kHz, 220 Hz, 1 kHz	1 mA
100 µA	5 kHz, 7,5 kHz, 9,7 kHz, 10 kHz, 220 Hz, 1 kHz	100 µA

Procédure suivante

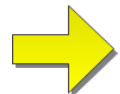

Étalonnage du zéro en CA

Cette procédure d'étalonnage concerne tous les modèles (34460A/61A/65A/70A).

Reportez-vous à la section **Considérations relatives aux tests** avant d'effectuer une procédure d'étalonnage.

Configuration : Tension alternative

1. Réglez l'appareil étalon sur 0,00 Vca.
2. Saisissez une valeur d'étalonnage de +0. (voir la section **Saisie des valeurs d'étalonnage**). Le message Calibration Step Succeeded (Étape d'étalonnage réussie) indique une réussite ; si l'écran affiche le message Calibration Step Failed (Échec de l'étape d'étalonnage), vérifiez la valeur du signal d'entrée, la plage, la fonction et la valeur d'étalonnage saisie, puis recommencez l'étape d'étalonnage.
3. Enregistrez les nouvelles constantes d'étalonnage (voir la section **Enregistrement des constantes d'étalonnage**).

REMARQUE Cette procédure d'étalonnage prend environ 10 secondes.

Procédure suivante

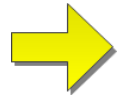

Étalonnage de la précision de fréquence

Cette procédure d'étalonnage concerne tous les modèles (34460A/61A/65A/70A).

Avant de commencer cette procédure, consultez les sections **Considérations relatives aux tests** et **Considérations relatives à l'étalonnage du gain**.

Configuration : Fréquence, plage de 10 V

REMARQUE La précision de fréquence de l'instrument Fluke 5720A est insuffisante pour étalonner le multimètre numérique. Sa sortie de fréquence doit être étalonnée par rapport à une référence plus précise. Le générateur de fonctions/signaux arbitraires Keysight série 33500B est recommandé pour cette procédure d'étalonnage.

1. Configurez l'instrument pour des mesures de fréquence à 10 V et 10 kHz, avec un temps de porte de 1 seconde.
2. Appliquez une onde sinusoïdale de 10 kHz, amplitude 20 Vpp.
3. Saisissez la fréquence d'entrée appliquée réelle (voir la section **Saisie des valeurs d'étalonnage**). Le message Calibration Step Succeeded (Étape d'étalonnage réussie) indique une réussite ; si l'écran affiche le message Calibration Step Failed (Échec de l'étape d'étalonnage), vérifiez la valeur du signal d'entrée, la plage, la fonction et la valeur d'étalonnage saisie, puis recommencez l'étape d'étalonnage.
4. Enregistrez les nouvelles constantes d'étalonnage (voir la section **Enregistrement des constantes d'étalonnage**).

REMARQUE Cette procédure d'étalonnage prend environ 1 seconde.

Procédure suivante

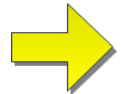

Étalonnage du gain en tension continue

Cette procédure d'étalonnage concerne uniquement les modèles 34465A et 34470A.

Avant de commencer cette procédure, consultez les sections **Considérations relatives aux tests** et **Considérations relatives à l'étalonnage du gain**.

Configuration : Tension continue

1. Configurez chaque fonction et plage dans l'ordre indiqué dans le tableau ci-dessous.
2. Appliquez le signal d'entrée indiqué dans la colonne Entrée.
3. **Saisissez l'amplitude de tension d'entrée réelle appliquée** (voir la section **Saisie des valeurs d'étalonnage**). Le message Calibration Step Succeeded (Étape d'étalonnage réussie) indique une réussite ; si l'écran affiche le message Calibration Step Failed (Échec de l'étape d'étalonnage), vérifiez la valeur du signal d'entrée, la plage, la fonction et la valeur d'étalonnage saisie, puis recommencez l'étape d'étalonnage.
4. Répétez les étapes 1 à 3 pour chaque point d'étalonnage de gain indiqué dans le tableau.
5. Enregistrez les nouvelles constantes d'étalonnage (voir la section **Enregistrement des constantes d'étalonnage**).

REMARQUE Chaque réglage de plage prend moins de 4 secondes.

Réglages de l'instrument		
Entrée	Fonction	Plage
10 V	V CC	10 V
-10 V		10 V
0,1 V		100 mV
-0,1 V		100 mV
1 V		1 V

REMARQUE Les plages 100 V et 1 000 V sont ajustées ultérieurement dans la section **Étalonnage du gain haute tension en tension continue**.

Procédure suivante

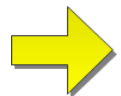

Étalonnage du gain de résistance

Cette procédure d'étalonnage concerne tous les modèles (34460A/61A/65A/70A).

Avant de commencer cette procédure, consultez les sections **Considérations relatives aux tests** et **Considérations relatives à l'étalonnage du gain**.

Configuration : Résistance en 4 fils

Cette procédure permet de régler le gain pour les fonctions de résistance en 2 et 4 fils, et la fonction de résistance à compensation de décalage.

1. Configurez chaque fonction et plage dans l'ordre indiqué dans le tableau ci-dessous.
2. Appliquez le signal d'entrée indiqué dans la colonne Entrée.
3. Saisissez la valeur réelle de résistance d'entrée appliquée (voir la section **Saisie des valeurs d'étalonnage**). Le message Calibration Step Succeeded (Étape d'étalonnage réussie) indique une réussite ; si l'écran affiche le message Calibration Step Failed (Échec de l'étape d'étalonnage), vérifiez la valeur du signal d'entrée, la plage, la fonction et la valeur d'étalonnage saisie, puis recommencez l'étape d'étalonnage.
4. Répétez les étapes 1 à 3 pour chaque point d'étalonnage de gain indiqué dans le tableau.
5. Enregistrez les nouvelles constantes d'étalonnage (voir la section **Enregistrement des constantes d'étalonnage**).

REMARQUE Chaque réglage de plage prend moins de 4 secondes.

Réglages de l'instrument		
Entrée	Fonction	Plage
100 Ω	Résistance en 4 fils	100 Ω
1 k Ω		1 k Ω
10 k Ω		10 k Ω
100 k Ω		100 k Ω
1 M Ω		1 M Ω
10 M Ω		10 M Ω
100 M Ω	Résistance en 2 fils	100 M Ω

Procédure suivante

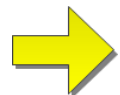

Étalonnage du gain en courant continu

Cette procédure d'étalonnage concerne uniquement les modèles 34465A et 34470A.

Avant de commencer cette procédure, consultez les sections **Considérations relatives aux tests** et **Considérations relatives à l'étalonnage du gain**.

Configuration : Courant continu

1. Configurez chaque fonction et plage dans l'ordre indiqué dans le tableau ci-dessous.
2. Appliquez le signal d'entrée indiqué dans la colonne Entrée.
3. Saisissez le courant d'entrée réel appliqué comme valeur d'étalonnage (voir la section **Saisie des valeurs d'étalonnage**). Le message Calibration Step Succeeded (Étape d'étalonnage réussie) indique une réussite ; si l'écran affiche le message Calibration Step Failed (Échec de l'étape d'étalonnage), vérifiez la valeur du signal d'entrée, la plage, la fonction et la valeur d'étalonnage saisie, puis recommencez l'étape d'étalonnage.
4. Répétez les étapes 1 à 3 pour chaque point d'étalonnage de gain indiqué dans le tableau.
5. Enregistrez les nouvelles constantes d'étalonnage (voir la section **Enregistrement des constantes d'étalonnage**).

REMARQUE Chaque réglage de plage prend moins de 4 secondes.

Réglages de l'instrument		
Entrée	Fonction	Plage
1 mA	Courant continu	1 mA
10 mA		10 mA
100 mA		100 mA
1 A		1 A
2 A		3 A

Procédure suivante

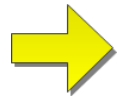

Étalonnage du gain en tension continue

Cette procédure d'étalonnage concerne uniquement les modèles 34465A et 34470A.

Avant de commencer cette procédure, consultez les sections **Considérations relatives aux tests** et **Considérations relatives à l'étalonnage du gain**.

Configuration : Tension continue

1. Configurez chaque fonction et plage dans l'ordre indiqué dans le tableau ci-dessous.
2. Appliquez le signal d'entrée indiqué dans la colonne Entrée.
3. **Saisissez l'amplitude de tension d'entrée réelle appliquée** (voir la section **Saisie des valeurs d'étalonnage**). Le message Calibration Step Succeeded (Étape d'étalonnage réussie) indique une réussite ; si l'écran affiche le message Calibration Step Failed (Échec de l'étape d'étalonnage), vérifiez la valeur du signal d'entrée, la plage, la fonction et la valeur d'étalonnage saisie, puis recommencez l'étape d'étalonnage.
4. Répétez les étapes 1 à 3 pour chaque point d'étalonnage de gain indiqué dans le tableau.
5. Enregistrez les nouvelles constantes d'étalonnage (voir la section **Enregistrement des constantes d'étalonnage**).

REMARQUE Chaque réglage de plage prend moins de 4 secondes.

Réglages de l'instrument		
Entrée	Fonction	Plage
100 V	Tension continue	100 V
500 V		1 000 V

Procédure suivante

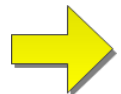

Étalonnage du gain 10 A en courant alternatif

Cette procédure d'étalonnage concerne uniquement les modèles 34461A, 34465A et 34470A (et non le modèle 34460A).

Avant d'effectuer cet étalonnage, reportez-vous aux sections **Considérations relatives aux tests** et **Considérations relatives à l'étalonnage de la planéité**.

Configuration : Courant alternatif

Toutes les procédures d'étalonnage en courant alternatif utilisent le filtre de mesure de bande passante 3 Hz.

1. Sélectionnez la plage de 10 A.
2. Appliquez le signal d'entrée de 5 A à 1 000 Hz.
3. Saisissez le courant d'entrée réel appliqué comme valeur d'étalonnage (voir la section **Saisie des valeurs d'étalonnage**). Le message Calibration Step Succeeded (Étape d'étalonnage réussie) indique une réussite ; si l'écran affiche le message Calibration Step Failed (Échec de l'étape d'étalonnage), vérifiez la valeur du signal d'entrée, la plage, la fonction et la valeur d'étalonnage saisie, puis recommencez l'étape d'étalonnage.
4. Enregistrez les nouvelles constantes d'étalonnage (voir la section **Enregistrement des constantes d'étalonnage**).

REMARQUE Cette procédure d'étalonnage prend environ 2,5 secondes.

Procédure suivante

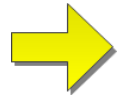

Étalonnage du gain 10 A en courant continu

Cette procédure d'étalonnage concerne uniquement les modèles 34461A, 34465A et 34470A (et non le modèle 34460A).

Avant d'effectuer cet étalonnage, reportez-vous aux sections **Considérations relatives aux tests** et **Considérations relatives à l'étalonnage de la planéité**.

Configuration : Courant continu

1. Configurez la plage de 10 A et définissez le temps d'intégration sur 100 PLC.
2. Appliquez l'entrée de 5 A.
3. Saisissez le courant d'entrée réel appliqué comme valeur d'étalonnage (voir la section **Saisie des valeurs d'étalonnage**). Le message Calibration Step Succeeded (Étape d'étalonnage réussie) indique une réussite ; si l'écran affiche le message Calibration Step Failed (Échec de l'étape d'étalonnage), vérifiez la valeur du signal d'entrée, la plage, la fonction et la valeur d'étalonnage saisie, puis recommencez l'étape d'étalonnage.
4. Enregistrez les nouvelles constantes d'étalonnage (voir la section **Enregistrement des constantes d'étalonnage**).

REMARQUE Cette procédure d'étalonnage prend moins de 4 secondes.

Procédure suivante

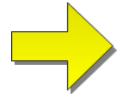

Étalonnage du décalage de capacité (en option)

Cette procédure d'étalonnage concerne tous les modèles (34460A/61A/65A/70A).

Cet étalonnage n'est en principe pas nécessaire. Il compense le décalage de capacité résiduel qui est généralement inférieur à quelques pF. Dans des conditions d'utilisation normales, tout décalage résiduel est remplacé par la fonction de mesure par rapport à une référence (cette dernière corrige également la capacité du câble), qui est nécessaire pour répondre aux spécifications de capacité du multimètre numérique.

Configuration : Capacité

1. Débranchez tous les connecteurs des bornes avant de l'instrument.
2. Sélectionnez les bornes avant.
3. Saisissez une valeur d'étalonnage (voir la section **Saisie des valeurs d'étalonnage**). Le message Calibration Step Succeeded (Étape d'étalonnage réussie) indique une réussite ; si l'écran affiche le message Calibration Step Failed (Échec de l'étape d'étalonnage), vérifiez la valeur du signal d'entrée, la plage, la fonction et la valeur d'étalonnage saisie, puis recommencez l'étape d'étalonnage.
4. Répétez les étapes 1 à 3 pour les bornes arrière de l'instrument (note applicable au modèle 34460A).
5. Enregistrez les nouvelles constantes d'étalonnage (voir la section **Enregistrement des constantes d'étalonnage**).

Procédure suivante

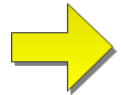

Finalisation de l'étalonnage

Pour finaliser l'étalonnage de votre instrument, procédez comme suit :

1. Déconnectez tous les blocs et connexions de court-circuitage de l'instrument.
2. Réinitialisez le **message d'étalonnage**.
3. **Verrouillez la sécurité de l'instrument** à l'aide du mot de passe d'étalonnage.
4. Enregistrez le **nouveau nombre de points d'étalonnage**.
5. Effectuez les **tests de vérification du fonctionnement** pour vérifier l'étalonnage.

Index

*

*CLS 282
*ESE 283
*ESR? 284
*IDN? 285
*LRN? 287
*OPC 287
*OPC? 288
*OPT? 288
*PSC 289
*PSC? 289
*RST 290
*SAV 289
*SRE 290
*STB? 291
*TRG 291
*TST? 292
*WAI 292

A

À propos du mode Numérisation 189
ABORt 215
AC 300, 305, 342, 395-401
ACALibration 415-416
acquisition de lectures 100
Activation de l'état des événements 289
Activation/désactivation du réglage automatique du zéro 184

ADC 251
ADDRess 429
ADJust 390
Admin (Administration) 156
Affichage de l'histogramme 141
Affichage de la barre de mesure 127
Affichage du diagramme de tendance (mode Continu) 130
Aide 42
Aide-mémoire 457
Aide-mémoire des commandes 457
Aide-mémoire des menus 51
Aide-mémoire des menus du panneau avant 51
ALL 222, 232, 244, 252, 309, 446
APERture 347, 357, 367-368, 380, 401
APERture Enabled 402
APERture ENABLEd 348, 380
assistance technique 36
Attente de déclenchement 291
AUTO 211, 234, 240, 260, 266, 268, 270, 298, 318-319, 336, 343, 345-346, 352, 359, 364, 372, 375, 378, 383, 393, 398, 400, 403, 407, 453
Autocal 282
autotest 511
Autotest 292
autotest à la mise sous tension 511
AVERage 226, 244, 246
Avertissements, sécurité 13

B

baie 45
BANDwidth 340, 395
Barre de mesure 127
Basse puissance 374, 386-387
batterie 517
BEEPer 416-417
blocs d'alimentation 504
BMP 279
BORDER 277
Bornes avant et arrière 221
Boucles de masse, bruit 174
Boucles magnétiques, bruit 174
Bruit provoqué par les boucles magnétiques 174
BUS 211, 455

C

CA 262, 268, 340-341, 343-347
CALCulate 226, 228-230, 232-242, 244, 246, 248-249
 histogram 232
 histogramme 233-235
 lissage 248
 STATe 249
 réglage d'échelle 242
 TCHart
 STATe 250
CALibration 251-256, 468
 STRing 255

CAN 571, 586
CAPacitance 260, 298, 334-338
Capacité 79
Caractères de fin de commande SCPI 210
caractéristiques 47
Caractéristiques 347, 367, 380, 401
CATalog 309, 445
CC 262, 270, 309, 341, 343-351
CD-ROM 207
CDIRectory 310
celsius 389, 391
Chaîne d'apprentissage 287
CHECK 388
Choix du type de sonde de température 183
Choix du type de sonde, Température 183
Chute de tension 203
CLEAr 233
CLEAR 226, 228, 246, 276
CLICK 417
CLS 210, 282
CODE 253
Commande *CAL? 282
Commandes courantes IEEE 488.2 280
Commandes IEEE 488.2 287
Commandes IEEE488.2 210
Commandes par sous-système 212
COMMunicate 428-438, 440
Commutation automatique 400

Commutation automatique de plage 260, 266, 268, 270, 298, 375

CONDition 411-412

configuration de l'interface de commande à distance 28, 33

Configuration des E/S 446-448

configuration du réseau local 28

Configuration LAN 33

CONFigure 260-264, 266-268, 270

CONFigure? 259

Configurer les E/S 152

Considérations relatives aux mesures 170, 187

Considérations relatives aux mesures de capacité 187

Considérations relatives aux mesures de résistance 175

Considérations relatives aux mesures, Capacité 187

Consignes de sécurité 13

contacter Keysight 36

Contenu en signaux à haute fréquence et précision de la valeur efficace vraie 179

Continuité 80

CONTinuity 261, 299, 333

CONTinuous 353

CONTrol 430

Conventions syntaxiques 208

COPY 311

COUNT 233, 244, 252, 325-326, 423, 447, 451

Courant alternatif 67, 333, 345-346

courant continu 401

Courant continu 65, 182, 333, 350, 352

Courant, CC 65

CSEPARATOR 322

CURRent 262, 300, 333, 340-353, 380

D

DATA 229, 232, 272-274, 277, 279, 322, 324

DATA2 354

DATE? 253, 415

DB 236

DBM 237

DC 270, 300, 305-306, 342, 352, 396-398, 402-407

déclenchement 100

Déclenchement 325, 328, 453

Déclenchement par niveau 189

DEFault 209

DELay 328, 452-453

DELeTe 446

Demande de service 430

activation 412

démontage 513

Dépannage 507

DESCription 447

DESired 294

Détails du déclenchement par niveau 96, 200

Device Clear 212, 430
DHCP 430
Diagramme 130
Diagramme de tendance (mode Continu) 130
Diagramme de tendance (Modes Numérisation et Enregistrement de données) 134
Didacticiel de mesure 169
Didacticiel V CC 60
Diode 81
DIODe 263, 301, 333
DISPlay 212, 275-276
Display (Affichage) - Introduction 120
Display (Affichage) - Number (Nombre) 122
DNS 431
DOMain 431
DOWNload 322

E

Effacement de l'état à la mise sous tension 289
Effets de la dissipation, minimisation 176
Effets du temps de stabilisation 202
En attente de déclenchement 327, 329, 331
ENABLE 293, 411, 413, 428, 441
End-Or-Identify 210
Enregistrement de données 84
Enregistrement de données, Diagramme de tendance 134

entretien 501, 557, 564, 573-574, 577-579, 581-582, 588-589, 592-594, 596-598
Erreur d'exécution 483
Erreur hors bande 180
Erreurs d'autotest 483
Erreurs d'étalonnage 483
Erreurs de commande 483
Erreurs de courant de fuite 205
Erreurs de FEM thermique 172
Erreurs de l'instrument 483
Erreurs de mesure de faible niveau 204
Erreurs de mesure de fréquence et de période 182
Erreurs de mesure de résistance élevée 177
Erreurs de mesure en courant alternatif (chute de tension) 203
Erreurs de mode commun 204
Erreurs de périphériques 483
Erreurs de requête 483
erreurs de résistance des cordons de test, suppression 175
Erreurs de signaux inutiles 205
Erreurs dues à la charge (tension continue) 172
Erreurs dues à la charge en courant alternatif (tensions alternatives) 202
Erreurs dues aux effets d'auto-échauffement 203
Erreurs dues aux effets d'auto-échauffement haute tension 203

ERRor 419, 447
ESE 210, 283
ESR? 284
Estimation de l'erreur en haute fréquence
(hors bande) 180
étalonnage 531, 535, 542-543, 549, 551-
552, 558-563, 571, 575, 584, 586,
590, 600
Étalonnage automatique 147
étalonnage de la planéité 575, 590
Étalonnage du décalage de capacité (en
option) 583, 599
Étalonnage du gain en courant
continu 580, 595
Étalonnage du zéro en CA 576, 591
État de réinitialisation 497
EVENT 273-274, 412-413
Exécuter la commande SAMPlE 329
Exécution d'une requête 210
Ext Trig BNC 455
EXTernal 211, 455

F

Factory Reset 418, 425
FAST 248, 353
FETCh? 216
Fichiers, Gérer 150
File d'erreurs 483
finalisation des réglages 584, 600
FNAMe 322
fonctions 47

Fonctions de réglage d'échelle 382
Fonctions du mode Enregistrement de
données 194
Fonctions mathématiques 241
Fonctions statistiques
valeur maximale 209
valeur minimale 209
FORMat 277, 279, 322-323
Format de retour 330
Fréquence 82
Fréquence de Nyquist 188
Fréquence et intervalle
d'échantillonnage 206
FREQuency 264, 302, 333, 357-359, 361-
365
FRESistance 266, 303, 333, 367-377
FRONt 221
FRTD 267, 304, 386, 388
FTHermistor 392
FUNCTion 237, 333

G

GAIN 238-239
GATeway 432
GPIB 207, 429

H

HCOPy 279
HELP 420
HI-Z 403
HISTogram 232-235

Histogramme 141

HNAME 294

HOST 441

HOSTname 433

HP34401A 421

I

I CA 67

I CC 65

I/O Configuration (Configuration des
E/S) 152

IDENTify 293, 421

IDN? 285

IMMediate 211, 217, 226, 228, 246, 416,
424, 455

IMPedance 403

Impédance d'entrée 403

Impédance d'entrée automatique 403

INFormation 323

Informations sur la sécurité 11

INITiate 217

INSTall 448

Interaction locale/à distance 192, 199

Interaction locale/à distance avec
l'enregistrement de données 192,
199

Interaction locale/à distance avec la
numérisation 192, 199

interface de commande à distance 28

Interface Web 162, 207

INTernal 453, 455

Interrogation série 291

Intervalle et fréquence
d'échantillonnage 206

IPADdress 434

IU Web 162

K

Keysight 36

Keysight IO Libraries Suite 207

L

La fréquence d'échantillonnage 188

LABel 422

LAN 430-438, 440

LAST 272

lecteur flash USB 441

Lecture NULL (Valeur de référence) 184

LEVel 453

LFRequency 422

LIcense 445-448

LIMit 228-230, 465

Limite de ligne 323

Limites de mesure 18

Limites de mesure des bornes
d'entree 18

Limites maximales 18

Limites, mesure 18

Limits (Limites) 116

LOAD 316-317

LOCal 423

LOCK 443-444

LOWer 229, 234, 361

LPOWer 374, 387

LRN 287

LXI 293-295

RESet 295

M

MAC 435

Manage Files (Gérer les fichiers) 150

Math (Opération mathématique) 116

Math (Opération mathématique) - Introduction 107

Math (Opération mathématique) - Null (Valeur de référence) 108

Math (Opération mathématique) - Scaling (Réglage d'échelle) 111

Math (Opération mathématique) - Statistics (Statistiques) 115

Math (Opération mathématique) Smoothing (Lissage) 114

MAXimum 209, 244

MDIRectory 310

MDNS 293-294

MEASure 298-306, 457

MEDium 248

Mémoire non volatile 403, 441

Menu Utility (Utilitaire) 146

Messages d'erreur 483

Mesure en-dessous de la pleine échelle 203

mesures 100

Mesures 59

Mesures de température 183

Mesures de valeurs efficaces vraies en courant alternatif 178

mesures en 2 fils 367-368, 373

Mesures en 2 fils et 4 fils 184

Mesures en courant alternatif haut débit 184

mesures en courant continu 478

Mesures en courant continu et de résistance haut débit 185

Mesures en tension continue 60

Mesures secondaires 98

Mesures V CC 60

Minimisation des effets de la dissipation de puissance 176

MINimum 209, 244

mise à jour du microprogramme 35

Mise sous tension/réinitialisation 497

MMEMory 309-312, 316-319, 322-324, 418, 425

DELeTe 311

MODE 353

Mode Continu 48

Mode de détermination de la fréquence/l'intervalle d'échantillonnage 206

Mode Enregistrement de données 48, 84, 193

Mode Numérisation 48, 90, 189

Modèles et options 26

montage dans une baie 45
mot de passe 561
MOVE 312
Moyenne, flottante 248-249
multimètre numérique 388-389, 391
multimètre numérique (DMM)
interne 388-389

N

NAME 443
NEGative 218, 455
NEXT 419
nombre 563
Nombre 326
 pré-déclenchement 326
nombre de points d'étalonnage 563
NPLC 347, 349, 367, 369, 380-381, 401,
 404
NULL 334-336, 341-343, 358-359, 370-
 372, 382-383, 396-398
Null (Valeur de référence) 108
Numérisation 90
Numérisation de mesures 188
Numérisation, Diagramme de
 tendance 134

O

OCOMPensated 373, 385
OFF
 commutation automatique de
 plage 336

ONCE 345-346, 352, 375, 378, 393, 400,
 407
OPC 210, 287-288
OPC? 288
OPERation 411-412
oPrésentation du langage SCPI 208
OPT? 288
Option GPIB 522
Options et modèles 26
Options installées en usine 26
Options installées par l'utilisateur 26
Options installées par le distributeur 26
OUTPut 218
OWNer 443

P

panneau arrière 25
panneau avant 24
Paramètres 210
Paramètres de chaînes de caractères
 ASCII 212
Paramètres discrets 211
Paramètres logiques (booléens) 211
Paramètres numériques 211
Paramètres par défaut 257, 296, 497
Paramètres par défaut des modes Enre-
 gistrement de données et Numé-
 risation 49
PERiod 302, 333, 357-359, 361-365
Période 82
Pièces détachées 512

Pièces, détachées 512
Pilotes 207
plage 475
planéité 575, 590
planéité du courant alternatif 575, 590
PLC 347, 367, 380, 401, 404, 475
PNG 279
Poignée 41
Poignée de transport 41
POINts 233, 272-273
POSitive 218, 455
Précision de la valeur efficace vraie et contenu en signaux à haute fréquence 179
PREferences 316
Préréglage de l'instrument 418, 425
Préréglage de l'instrument 277, 328, 332, 497
Présentation de l'instrument 23
Présentation du sous-système SAMPLE 325
PRESet 327, 412, 418, 423, 425, 497
PRETrigger 326
Probe Hold (Maintien de la sonde) 106
PROMpt 437
PSC 289, 411, 413
PTPeak 244

Q

QUEStionable 412-413

R

R? 219
RANGe 234, 336-337, 344-345, 361, 363-364, 374-375, 399-400
RATio 270, 306, 333, 405
RCL 289
RDG_STORE 324
RDIRECTory 310
READ? 220
READing 322-323
réalisation de lectures 100
Réalisation de mesures en courant alternatif haut débit 184
Réalisation de mesures en courant continu et de résistance haut débit 185
REAR 221
RECall 318-319
Récapitulatif des commandes 257, 277, 296, 325
Récapitulatif général 291
REFerence 236-237, 240, 386
Registre de l'octet d'état 289
Registre des données douteuses 289
Registre des événements standard 289
Registre des opérations standard 289
Réglage automatique du zéro 330, 352, 407
Réglage d'échelle
fonction 341-343, 358-359, 370-372, 382

référence 270, 306

Réglage d'échelle 242, 466

- fonction 333
- unités 242

Réglage d'échelle dB 109

Réglage d'échelle dBm 109

Réglage d'échelle Mx-B 241

Réglage d'échelle, dB/DBM 109

réglage du gain 558-559

Réglage du zéro automatique 378

réglages 551, 559-560, 571, 584, 586, 600

Réglages d'usine 497

réglages de l'étalonnage 560

réglages de planéité 559

réglages des multimètres 34460A et 34461A 570

réglages des multimètres 34465A et 34470A 585

réglages des multimètres 34470A et 34465A 585

réglages du multimètre 34461A 570

réglages du multimètre 34470A 585

Réinitialisation de la configuration

- d'usine 277, 290, 327, 329, 332, 334-335, 347, 367, 380, 401, 497

Réjection des tensions de bruit engendrées par l'alimentation secteur 173

Réjection du bruit 173

RELease 443

REMOVe 274

remplacement des fusibles 519

Remplacement des fusibles 519

remplacement des fusibles de courant 519

remplacement des fusibles internes 519

remplacement du code de sécurité 524, 565

Renvois

- commutation automatique de plage 336
- pré-déclenchement 326

réparation 501, 557, 564, 573-574, 577-579, 581-582, 588-589, 592-594, 596-598

Replie ment 188

REQuest 444

réseau local

- configuration 294

RESistance 266, 303, 333, 369-378, 386

Résistance 69

Résistance à 2 fils 69, 266, 333, 375-376

Résistance à 4 fils 69, 266, 333, 374-376

Résistance en 2 fils 374

RESolution 350, 376, 380, 405

résolution 475

RESolved 294

RESPonse 248

REStart 295

Retard de déclenchement 102, 452

Retard, déclenchement 102

retards de déclenchement 479

retards de déclenchement
automatiques 479

retards, déclenchement 479

Retour 337

RJUNction 390

RLIMit 323

ROUTe 221

RST 210, 290, 418, 425

RTD 267, 304, 382, 386, 388, 392

RTD 4 fils 382

RTD à 2 fils 267

RTD à 4 fils 267

S

SAMPlE 325-326, 328-329

Sauvegarde et rappel de la
configuration 148

Sauvegarde et rappel des
préférences 148

SAV 289

SCALe 236-242

Scaling (Réglage d'échelle) 111

SDEViation 244

SDUMp 279

SECondary 347, 351, 365, 384, 401, 405-
406

SECondary, CAPacitance 338, 377

SECure 253-254

sécurité 561

SECurity 423-424

SElect 319

SENSe 333-338, 340-353, 357-359, 361-
365, 367-378, 380-388, 390, 392-
393, 395-407

DATA2? 354

Séparateurs de commandes 209

SLOPe 218, 455

SLOW 248

SMASk 436

SMOothing 248-249

Smoothing (Lissage) 114

SNAME 294

Sortie VM Comp (BNC) 482

SOURce 328, 453, 455

Sous-système CALCulate

AVERage 243

HISTogram 231

LIMit 227

SCALe 236

Sous-système CALCulate -
Présentation 224

Sous-système CALibration 251

Sous-système CONFigure 257

Sous-système DATA 272

Sous-système DISPlay -
Présentation 275

Sous-système FORMat 277

Sous-système HCOPy 279

Sous-système LXI 293

Sous-système MEASure 296

Sous-système MMEMory - Commandes
de transfert de données 320

Sous-système MMEMory - Fichiers STATE et PREFerence 313

Sous-système MMEMory - Gestion de fichiers de base 307

Sous-système SENSE

{FREQuency|PERiod} 356

{RESistance|FRESistance} 366

CURRent 339

DATA2 354

TEMPerature 379

VOLTage 394

Sous-système SENSE - Présentation 333

Sous-système STATus 408

Sous-système SYSTem

LICense 445

LOCK 442

Sous-système SYSTem - Commandes de base 414

Sous-système SYSTem - Configuration des E/S 427

Sous-système TRIGger 450

SRE 290

STATE 230, 235, 241-242, 246, 254, 293, 317-319, 334-336, 341, 358, 370, 382, 396, 417

Statistics (Statistiques) 115

STATus 411-413

STB? 291

STORe 254, 316-317, 324

Suppression des erreurs de résistance des cordons de test 175

suspendre des mesures 106

SWITCh 353

Symboles de sécurité 13

Symboles, sécurité 13

SYSTem 416-426, 428-438, 440-441, 443-448

DATE 418

TIME 425

System Setup (Configuration système), système 159

Système d'aide 42

T

tableau d'intégration 478

tableau de plages 475

tableau de résolution 475, 478

TELNet 437-438

TEMP? 255, 415

TEMPerature 211, 223, 267, 304, 380-386, 388, 390, 392-393, 424

Température (34460 et 34461A) 72

Température (modèles 34465A et 34470A) 74

temps d'intégration 478

Tension alternative 63, 268, 333, 399-400

Tension continue 60, 333, 403-405, 407

Tensions d'alimentation 507

Tensions de bruit engendrées par l'alimentation, réjection 173

TERMinals 221, 346

TEST 222
Test/Admin (Test/Administration) 156
Tests de vérification 528
Tests de vérification du
fonctionnement 528
TEXT 212, 275-276
Théorie de capacité 186
THERmistor 387, 392
thermocouple 388-389, 391-392
THReshold 273-274
TIME? 256, 416
TIMeout 362
TIMer 329
définir 329
Touche Local 275
touches du panneau avant 51
TRANsducer 386, 388, 392
TRANsform 232-235
TRG 291
TRIG 453
TRIGger 218, 451-453, 455
TST? 292
TYPE 388
type de thermocouple 392
Types de paramètres SCPI 211

U

UNIT 211, 223, 241-242
unités 389, 391
UPDate 438

UPLoad 324
UPPer 229, 234, 337, 344, 363, 374, 399
UPTime 425
Utility (Utilitaire), Store and Recall (Sau-
vegarde et rappel) 148

V

V CA 63
VALid 319
VALue 256, 335-336, 342-343, 359, 371-
372, 382-383, 397-398
vérification 535, 542-543, 549
vérification de la tension 543
vérification de la tension alternative 543
Vérification des mesures de capacité (test
de vérification en option) 550
vérification du courant 543
vérification du courant alternatif 543, 549
vérification du courant continu 549
vérification du décalage du zéro 531
vérification du gain 535, 542
vérification du gain de fréquence 542
VERSion 425
VIEW 276
VOLTage 268, 270, 305-306, 363-364,
395-407
Voltmeter Complete (Mesure
terminée) 482

W

WAI 292
WINS 440

WMESsage 426, 438

Z

ZERO 352, 378, 393, 407

© Keysight Technologies, Inc. 2013 - 2023

All rights reserved.

Référence: 34460-90912

Imprimé en Malaisie : Édition 10, septembre 2023

