

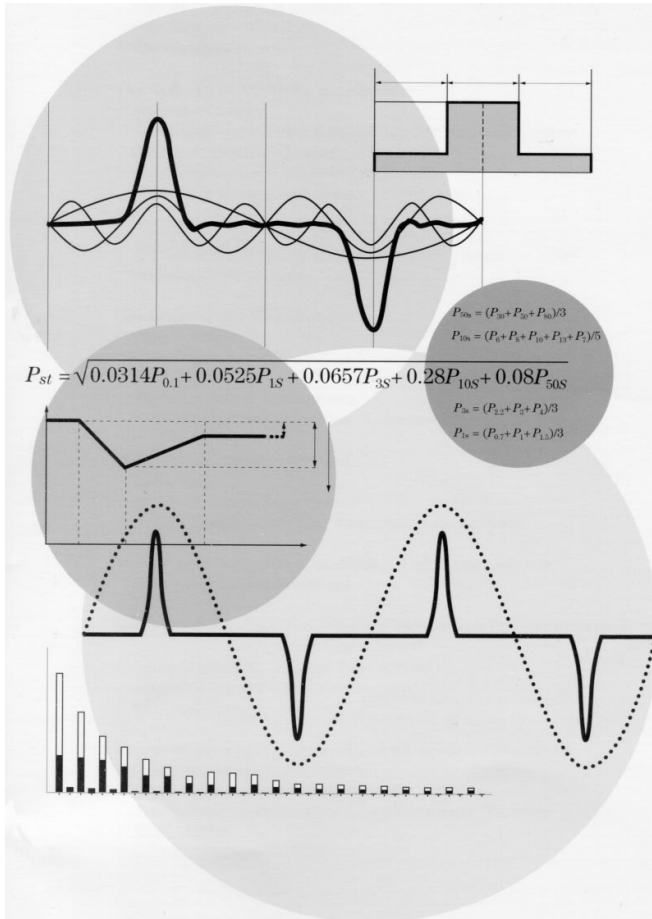

Agilent AN 1273

Compliance Testing to the IEC 1000-3-2 (EN 61000-3-2) and IEC 1000-3-3 (EN 61000-3-3) Standards

Application Note



Regulatory standards for ac mains phenomena are critical to maintaining the quality of ac power distribution systems. The goal of this application note is to provide an introduction to these standards as well as insight into their scope and intent. An effort has also been made to openly explore the interpretive as well as technical issues of the standards. The discussion of these issues is included to stimulate end-users who test products for compliance to consider both the interpretive and technical merit of test solutions. This application note discusses the following topics:

- the origins of harmonic current, voltage fluctuation, and flicker phenomena
- IEC 1000-3-2 (1995), EN 61000-3-2 (1995), IEC 1000-3-3 (1994), EN 61000-3-3 (1995) and related standards
- Agilent Technologies' interpretation of the standards with regard to test solution implementation
- the Agilent 6840 Series Harmonic/Flicker Test System

Although this document offers a comprehensive discussion of the above standards and Agilent's test solution, it is most beneficial when read with reference to the relevant standards.



Agilent Technologies

Innovating the HP Way

Table of Contents

Introduction	3	Implementation of IEC 1000-3-2 and EN 61000-3-2 Standards	29
IEC 1000-3-2 and 1000-3-3 Standards and the Implications for Electronics Manufacturers	3	Harmonic Current Measurements	29
Understanding the Regulatory Testing Environment	4	Agilent 6840 Series Measurement Accuracy	30
The Relationship between the IEC, CENELEC, and the European Union	4	Measurement Synchronization Using Rectangular Windows	31
EMI/RFI Standards in General	4	Shunt Burden	33
Low Frequency Emissions	5	1.5 Second Smoothing Filter	33
The Standards Process	5	Source Impedance	33
The Necessity of AC Mains Regulations	6	The Pre-Test Window for Class Determination	34
Harmonic Currents	6	Class D Active Power Tests and the Special Waveshape Requirement	35
Why Switch-mode Power Supplies Generate Harmonic Currents	7	Class C Power Factor and Fundamental Current Measurement	37
Effects of Harmonic Currents	8	Class B Harmonic Current Limits	37
Quasi-stationary and Fluctuating Harmonics	8	Voltage Distortion Measurement	38
Voltage Fluctuations and Flicker	9	Delay to Start of Test	38
An Overview of IEC 1000-3-2 (EN 61000-3-2) and IEC 1000-3-3 (EN 61000-3-3) Requirements	11	Programmable Current Limits	39
The Difference Between Precompliance and Compliance Testing	12	Implementation of IEC 1000-3-3 and EN 61000-3-3 Standards	40
Reference Methodologies	12	Flicker Measurement—UIE Flickermeter	40
IEC 1000-3-2 and EN 61000-3-2	13	RMS Measurements	40
Class Definition	13	Pst Classifier	41
Class D Equipment	14	Agilent 6840 Series Flickermeter	41
Test Limits	15	Use of a Simulated Impedance	42
AC Power Source Requirements	16	Squarewave Response Tests per IEC 868	42
Harmonic Current Measurement Requirements	16	Unclear Definitions for Dmax, Dc, and Dt	44
IEC 1000-3-3 and EN 61000-3-3	18	Delay to Start of Test	47
Test Limits	19	Appendix A	48
AC Power Source Requirements	19	Flickermeter Verification Tests	48
Voltage Fluctuations/Flicker Measurement Requirements	20	Quantization Errors	50
The Agilent 6840 Series Harmonic/Flicker Test System Solution	21	References	55
Basic Measurement Definitions	22	Reading This Application Note	
Interpretive Issues for Test Solutions Vendors and Equipment Manufacturers	23	This application note is written with two audiences in mind. The first part of the application note, from pages 3 to 22, is for readers who wish to familiarize themselves with the IEC 1000-3-2 and 1000-3-3 (EN 61000-3-2 and 61000-3-3) standards. This general discussion concludes with a brief description of the Agilent 6840 Series Harmonic/Flicker Test System.	
Normative References and Their Scope	23	The second part of the application note, from pages 23 to 55, is for readers who are familiar with IEC 1000-3-2 and 1000-3-3 (EN 61000-3-2 and 61000-3-3) and are aware of some of the technical and interpretive issues surrounding the standards. These pages identify the issues and describe in detail how Agilent has resolved them with the 6840 Series Harmonic/Flicker Test System.	
Stated, Implied, and Inferred Requirements	24		
Appropriateness of Requirements	25		
Technical Errors	26		

Introduction

IEC 1000-3-2 and 1000-3-3 Standards and the Implications for Electronics Manufacturers

The quality of distributed electrical power has become a critical concern in recent years. This concern has grown with the advent of positive industry trends to improve electrical product efficiency and with the proliferation of electronic equipment in households and commercial environments. Interestingly enough, the very technology that allows for more efficient use of electrical energy, switch-mode power conversion technology, is also a culprit that can negatively impact power quality. Switch-mode power supplies can draw high harmonic currents from the ac mains, which can cause a variety of undesirable effects in the ac power distribution system. The end result for electronic products connected to the ac mains can be improper operation, over-stressed ac input components, and product failure. The power distribution system must bear the burden of excessive neutral currents that over-stress neutral wiring and inefficient power transmission to the loads connected to the system.

The power quality of the ac mains can also deteriorate due to voltage fluctuations caused by devices such as electronic ballasts and light dimmer switches. The phase-controlled ac input of these devices may cause large rms current changes on the ac mains, which result in substantial rms voltage deviations. In addition, the amplitude and frequency of these deviations can cause incandescent lamps to flicker, which can be irritating to humans.

Concern has grown regarding the consequences of these ac mains phenomena. This has resulted in action from worldwide regulatory commissions to update requirements of standards and implement regulations for electrical and electronic products. In fact, the European Union considers these consequences sufficiently severe as to require compliance to harmonic emissions standards under the requirements of the EMC Directive. These standards were most recently known by their older voluntary versions, the IEC 555-2 and 555-3 (EN 60555 parts 2 and 3) standards. Very recently, these standards have been revised and published as the IEC 1000-3-2 and 1000-3-3 (EN 61000-3-2 and 61000-3-3) standards, which set the limits for harmonic current emissions and voltage fluctuations and flicker.

The publication of these standards in the Official Journal of the European Union (OJEC) and their impact on the ability of electronic and electrical equipment manufacturers to participate in the worldwide marketplace has greatly increased industry anxiety levels. The intent of this application note is to clarify the requirements of the standards, identify some of the technical and interpretive issues raised by the standards, and explain how the capabilities of Agilent's test solution greatly simplify compliance testing to these standards.

Understanding the Regulatory Testing Environment

The Relationship between the IEC, CENELEC, and the European Union

Although the necessity of regulations such as IEC 1000-3-2 and 1000-3-3 may be well understood, the same may not be said of the process that drives their development. The worldwide organization responsible for developing most of the electrical standards related to the commercial and consumer industry is the International Electrotechnical Commission, or IEC. Through liaisons with international, national, and other standards-writing organizations as well as its own IEC Technical Committees, the IEC develops and publishes electrical standards and guidelines for voluntary use for entire industries at large. The IEC standards and guidelines can then be harmonized into national and regional standards without any alteration; any differences are clearly documented. The national and regional standards have different designations for the same IEC standard. For example, EN 61000-3-2 is the European Union version of IEC 1000-3-2 and is a regional standard published and ratified by CENELEC. BSEN 61000-3-2 refers to the national United Kingdom version of the EN 61000-3-2 standard.

The European Union and the European Free Trade countries have the need to develop new EMI/RFI immunity and emission standards. Their goal is to establish a comprehensive and uniform set of requirements for compliance to the EMC Directive (89/336/EEC). All electrical or electronic products under the scope of the EMC Directive intended for sale and distribution in the participating countries will be required to comply, and must carry the “CE mark” or label as proof of compliance by January 1, 1996. The specific requirements and associated detail are covered in the EMC Directive publication and its addendums. IEC and CENELEC are therefore working in close collaboration to prepare these standards related to the EMC Directive, which will be published under the IEC and EN designations.

EMI/RFI Standards in General

The IEC standards are developed by committees and sub-committees comprised of national committee members. The IEC TC77 committee has the responsibility for creating standards that address most aspects of electromagnetic disturbances. They have classified these disturbances in terms of low and high frequency conducted, magnetic, and radiated phenomena; electrostatic discharge; and nuclear electromagnetic pulse phenomena. Once published, these standards will be designated by the following formats:

- **IEC 1000-1-x** General considerations, definitions and terminology
- **IEC 1000-2-x** Description and classification of the environment levels and compatibility
- **IEC 1000-3-x** Emission and immunity limits
- **IEC 1000-4-x** Testing and measurement methodologies and techniques
- **IEC 1000-5-x** Installation and mitigation guidelines
- **IEC 1000-9-x** Miscellaneous

Low Frequency Emissions

Sub-committee A of IEC TC77 is responsible for conducted low frequency disturbances including those that pertain to ac power distribution systems. One of the committee's efforts has been the revision of the IEC 555-2 and 555-3 emissions standards, which led to the development of the new IEC 1000-3-2 and 1000-3-3 standards and the corresponding CENELEC versions (EN 61000-3-2 and 61000-3-3).

The Standards Process

Electrical and electronic equipment manufacturers usually have a critical need to understand when compliance to a standard is required. The process by which a document becomes an IEC standard involves several drafts or revisions, and typically takes anywhere from 4 to 12 years. While in the form of a revision, the "pre-standard" document is identified by an IEC designation and number that reflects the committee preparing the standard and the particular revision cycle. For example, the IEC 1000-3-3 standard prepared by sub-committee TC77A was designated as IEC 77A(CO)38 during its Draft International Standard stage just prior to approval. Compliance to a "pre-standard" document during any stage of the revision process is not required because the potential for change still exists and the committees have not officially approved the document for release.

These documents are released to National Committees solely for the purpose of technical commentary, and are not intended to be used as testing guidelines. It is not until the representative IEC National Committees vote on and approve the document for publication that it becomes an official IEC standard. The IEC 1000-3-2 and 1000-3-3 standards will not become regulations (i.e., a mandatory test requirement) for the European Union until CENELEC harmonizes the documents and the European Commission publishes them in the Official Journal, scheduled for January, 1996. They are now listed with reference to the EMC Directive as the EN 61000-3-2 and 61000-3-3 standards.

The Necessity of AC Mains Regulations

Harmonic Currents

Up until the last few decades, ac mains harmonic currents were mainly a concern in heavy industrial environments because of the type of loading this equipment placed on the electrical distribution system. Facilities of this type were the main users of electrical equipment with phase-angle controlled and rectified power devices. Most households and commercial environments still used fairly simple inductive and resistive electronic devices or loads such as incandescent lights, motors, and heaters. When connected to the sinusoidal voltage of the ac mains, these loads draw a sinusoidal current waveform which has little or no harmonic content (see Figures 1 and 2).

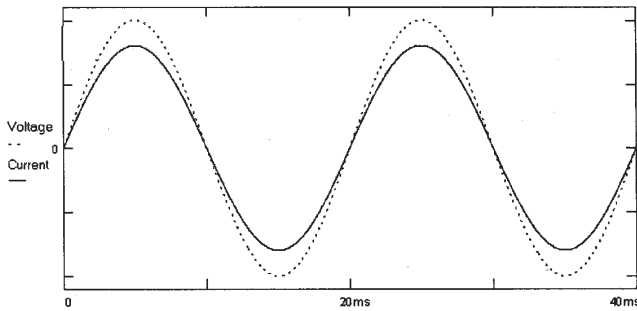

Figure 1. Resistive load

The proliferation of electronic equipment such as computers, printers, televisions, and audio equipment has expanded the harmonic current problem to households and commercial environments. This equipment has ac input circuitry that draws non-sinusoidal currents (see Figure 3). Typically, this input circuitry consists of a switch-mode power supply with a capacitor-diode rectifier input stage. Devices such as lamp dimmers and electronic ballasts also draw non-sinusoidal currents because of the phase-angle control circuits used to regulate the input power.

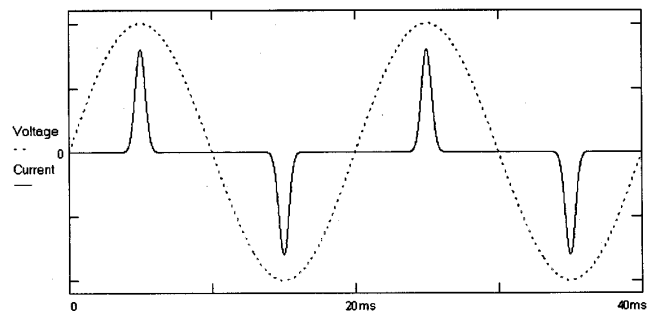

Figure 3. Non-sinusoidal currents

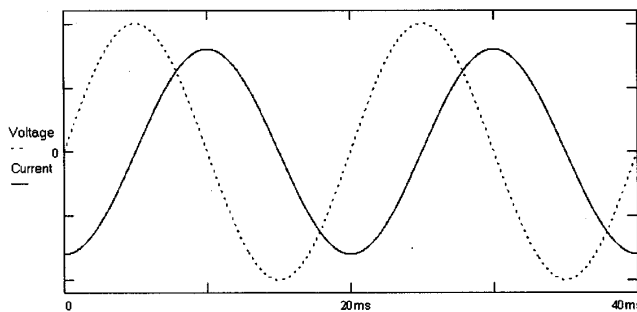

Figure 2. Inductive load

Why Switch-mode Power Supplies Generate Harmonic Currents

Although switch-mode power supply technology offers high efficiency in a small size, power supplies using this technology are one example of a generator of ac mains harmonics. Switch-mode power supplies typically have a capacitor-diode rectifier input stage, which creates a high voltage dc source from the ac input voltage (see Figure 4). This dc voltage is then modulated or chopped to provide a regulated voltage to the load. When the ac voltage is first applied, the charging of the capacitor is accompanied by a large inrush of ac current until the capacitor is charged to the peak value of the rectified voltage. Once the inrush conditions subside, the diodes conduct ac current and charge the capacitor only when the ac voltage is greater than the capacitor voltage. AC current flow is blocked by the diodes when the ac voltage is lower than the capacitor voltage (see Figure 5).

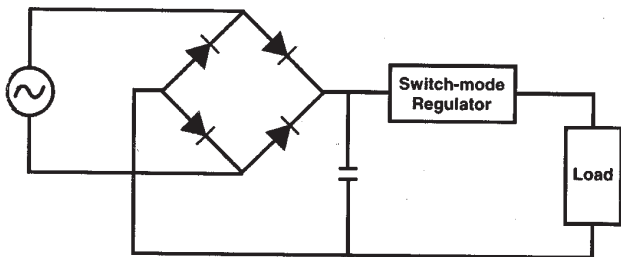

Figure 4. Switch-mode power supply circuit

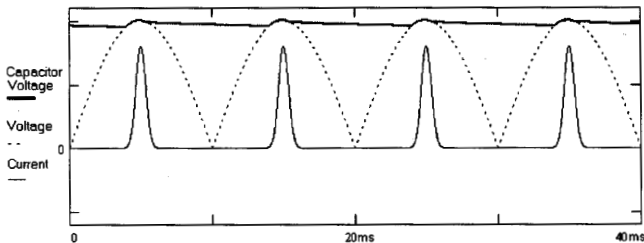

Figure 5. Capacitor voltage with rectifier voltage and current waveforms

The charging of the capacitor at the peak of the ac voltage waveform causes ac current to flow through the capacitor in successive narrow current pulses. This creates a nonlinear ac mains current that is harmonically rich. This current waveform is made up of odd-order harmonics which are integer multiples of the fundamental frequency (see Figure 6).

The current fundamental and odd harmonic amplitudes sum at 90 degrees and 270 degrees of the fundamental, which creates the current pulse waveform. If the fundamental frequency is 50 Hz, the 3rd harmonic is at 150 Hz, the 5th harmonic is at 250 Hz, and so on. This type of current waveform is representative of the Class D equipment with a "special wave shape" as described by IEC 1000-3-2 and EN 61000-3-2.

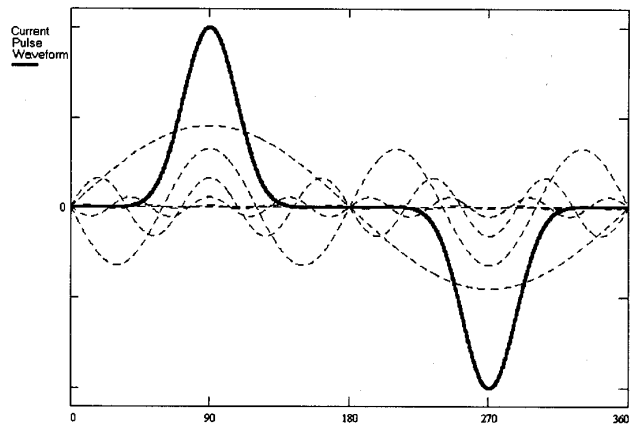

Figure 6. Summing odd harmonic currents

Effects of Harmonic Currents

Electronic equipment and devices that cause nonlinear current waveforms produce many detrimental effects on the ac power distribution. As more of these devices load the ac power distribution system, the following problems can occur:

- Significant current can flow that does not deliver real power and must be supported by the ac distribution system.
- Elevated neutral currents can flow in three-phase wye distribution systems which cause ampacity ratings for wiring and connectors to be exceeded.
- Equipment connected to the same branch circuit can operate improperly due to severe voltage distortion caused by harmonic currents interacting with impedances in the distribution system. For example, suppressed or clipped peak voltage limits the ability of computer power supplies to ride through momentary ac mains sags.

Equipment manufacturers generally use power factor correction (PFC) circuitry to minimize the effects of nonlinear loads and the power inefficiencies they cause. Testing to the harmonic current regulations helps to ensure that these power factor correction circuits are designed and operating properly.

Quasi-stationary and Fluctuating Harmonics

The harmonic current distortion caused by a nonlinear load on the ac mains can be classified in one of two general categories: quasi-stationary or fluctuating. Quasi-stationary or steady-state harmonic currents are produced by electronic equipment that generates non-varying levels of current distortion, where the amplitude of each harmonic remains constant over time. This equipment appears as an unchanging load on the ac mains (see Figure 7). Examples include test and measurement instrumentation such as oscilloscopes and multimeters, electronic ballasts, and video display equipment.

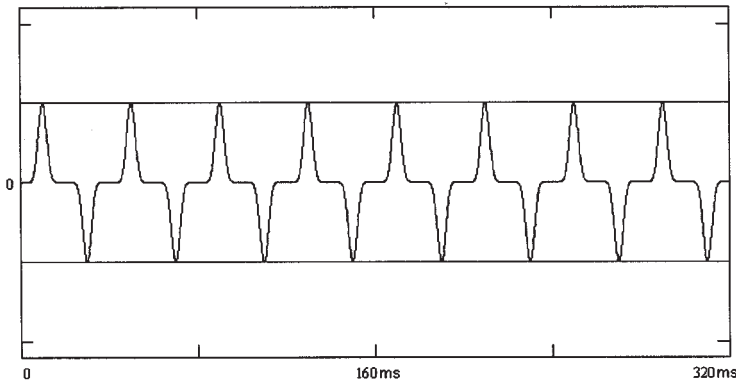

Figure 7. Steady-state harmonic currents

In contrast, fluctuating harmonic currents are caused by electronic equipment that represent time-varying loading on the ac mains. This equipment generates varying levels of current consumption or drain where the amplitude of individual harmonics change over time (see Figure 8). Examples include microwave ovens, dishwashers, laser printers, and photocopiers. The IEC 1000-3-2 and EN 61000-3-2 standards address both classes of harmonic currents.

Different measurement considerations and methodologies are used for determining compliance for the two classes, with more stringent testing methods applied to the fluctuating harmonic class. In particular, compliance testing for fluctuating harmonics requires non-stop harmonic analysis over extended periods of time.

Voltage Fluctuations and Flicker

In addition to loads that cause harmonic currents on the ac mains, there are also loads that have automatic turn on/turn off controls such as thermostats and timers. Kitchen appliances, space heaters, air conditioners, copiers, and other equipment include these type of controls. These loads are frequently resistive in nature, which means that they draw sinusoidal currents and generate no harmonics except during transient events.

When automatic controls cycle on and off, they cause frequent changes of the load to the supply. When the fluctuating load is in a branch circuit with other loads, these changes cause rms voltage fluctuations that affect all of the loads in the branch (see Figure 9). In particular, variations in voltage amplitude cause changes in the light output of any filament lamps in the branch circuit. Because the output of a filament lamp is proportional to the square of the applied voltage, changes in light intensities can be significant even for small changes in voltage.

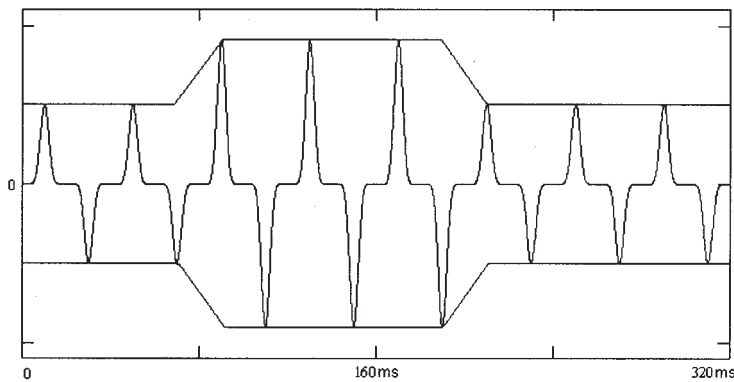

Figure 8. Fluctuating harmonic currents

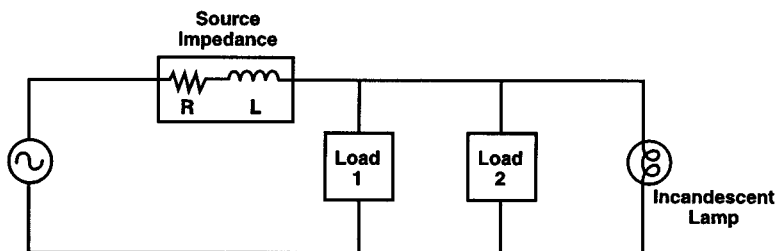

Figure 9. Branch circuit loads

This effect of variation in light output as perceived by the human observer is referred to as **flicker**. Because flicker is annoying, and for some individuals presents a health hazard (persons that have epilepsy for example), the standard seeks to regulate flicker generation to an acceptable level. Figure 10 illustrates an rms voltage variation on the ac mains. Figure 11 is from the IEC standard that defines such a voltage change characteristic. The voltage change characteristic defines changes in rms voltage levels, $U(t)$, in terms of percentage of nominal line voltage, U_n .

The IEC 1000-3-3 and EN 61000-3-3 standards address voltage fluctuations and flicker. Compliance with these standards ensures that voltage disturbances in the electrical distribution system do not interfere with other equipment connected to the ac mains or cause incandescent lights to visibly flicker in a way that causes an annoyance or health risk to a human observer.

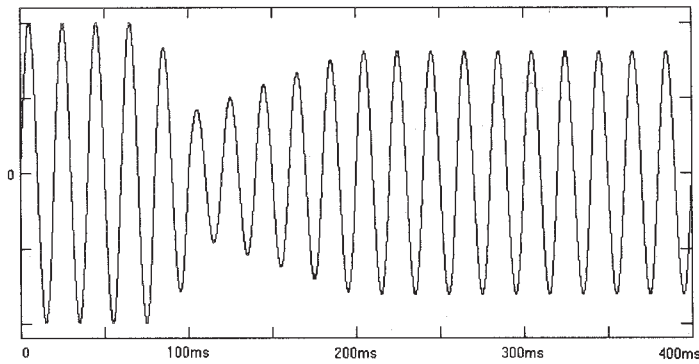

Figure 10. Variations in voltage amplitude

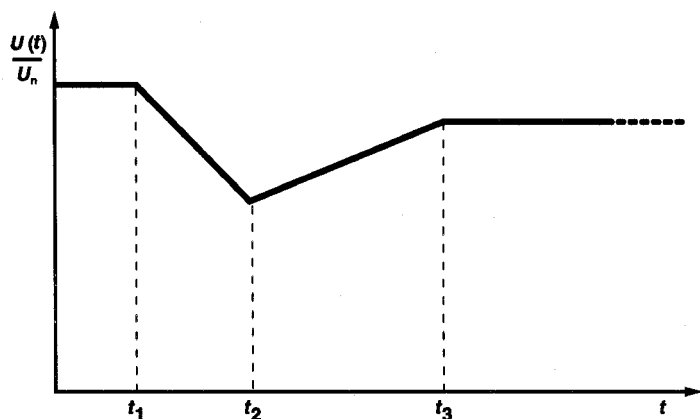

Figure 11. Voltage change characteristic

An Overview of IEC 1000-3-2 (EN 61000-3-2) and IEC 1000-3-3 (EN 61000-3-3) Requirements

Developed as part of a comprehensive strategy to set guidelines for EMC compliance under the EMC Directive, the recently published standards include the following:

- **IEC 1000-3-2 (1995)/EN 61000-3-2 (1995):** Specifies the limits for harmonic currents created by equipment connected to public low-voltage supply systems. These standards cover both quasi-stationary harmonics and fluctuating harmonics.
- **IEC 1000-3-3 (1994)/EN 61000-3-3 (1995):** Specifies the limits for voltage fluctuations and flicker produced by equipment connected to public low-voltage supply systems.

The specified limits are applicable to distribution systems with nominal voltages of 230 V (single-phase) and 400 V (three-phase) at 50 Hz, and for all electrical and electronic equipment with rated currents up to 16 Amps. The harmonics of interest are the 2nd through the 40th harmonic. Note that IEC 1000-3-2/EN 61000-3-2 also refers to 60 Hz systems, but IEC 1000-3-3/EN 61000-3-3 does not.

There currently appears to be a wealth of confusion regarding the effective dates of these standards and when they will become mandatory for all products shipped into the European Community. Much discussion is being focused on the criteria that constitutes whether or not an electronic product must comply when the standards are published

as part of the EMC Directive guidelines in January 1996, or whether mandatory compliance should be enforced after the official date of withdrawal of the older versions of the standards on January 1997 (for EN 60555 part 2) or June 1998 (for EN 60555 part 3). In addition, there may be temporary certification clauses exempting certain products depending on the date of introduction into the marketplace and whether they conform to the older versions of the standards.

IEC 1000-3-2 and EN 61000-3-2 and Related Standards

Published Version	Older Version	Normative Reference
IEC 1000-3-2 (1995)	IEC 555-2 (1982)	IEC 1000-4-7 (1991)
EN 61000-3-2 (1995)	EN 60555-2 (1987)	

IEC 1000-3-3 and EN 61000-3-3 and Related Standards

Published Version	Older Version	Normative References
IEC 1000-3-3 (1994)	IEC 555-3 (1982)	IEC 725 (1981)
EN 61000-3-3 (1995)	EN 60555-3 (1987)	IEC 868 (1986)
		IEC 868 Amendment 1 (1990)

The Difference Between Precompliance and Compliance Testing

Testing requirements can differ based on the desired end result. Precompliance testing is traditionally used during product development to provide confidence that the equipment under development can meet the standard prior to full compliance testing at an outside regulatory laboratory. The instrumentation used is typically general purpose equipment found in any well-equipped lab and is often less expensive than that used in compliance testing. Precompliance testing provides a cost-effective means of ensuring that money invested in external testing services will result in the equipment being certified for compliance.

Compliance testing requires instrumentation that has traceable specifications which guarantee performance levels sufficient to certify that equipment meets the required standards. More importantly, this equipment must meet any special performance characteristics defined by the associated normative reference standards. Compliance-level test instrumentation is generally more expensive than that used for precompliance testing. The Agilent 6840 Series Harmonic/Flicker Test System, however, effectively utilizes new technology to provide compliance-level testing at costs significantly below precompliance test instrumentation.

Reference Methodologies

Compliance-level testing often encompasses several possible testing methodologies as defined by the standards. The rating of these methodologies range from “acceptable,” which represents the lowest level of test instrumentation performance necessary to meet the compliance-level testing requirements, to the “most preferred” methodologies, which represent the optimum level of test instrumentation performance endorsed by the standards committee. The “most preferred” testing methodologies are called reference methodologies. Equipment utilizing these methodologies meets the most stringent performance requirements and the most preferred test and measurement techniques. For example, IEC 1000-3-3 uses this categorization for instruments that can assess all types of voltage fluctuations by direct measurement using a UIE/IEC flickermeter as defined by IEC 868. The Agilent 6840 Series Harmonic/Flicker Test System utilizes reference-level methodologies both for measuring voltage fluctuations and flicker for IEC 1000-3-3, and for measuring harmonic currents for IEC 1000-3-2.

IEC 1000-3-2 and EN 61000-3-2

The IEC 1000-3-2 and EN 61000-3-2 standards define measurement requirements, ac power source requirements, and limits for testing the harmonic current emissions of electronic and electrical equipment. Additional harmonic current testing and measurement techniques and instrumentation guidelines for these standards are covered in IEC 1000-4-7. IEC 1000-3-2 and EN 61000-3-2 also provide definitions for commonly used terms used throughout the standards and describe test conditions for particular types of equipment in Annex C.

Compliance to these standards ensures that tested equipment will not generate harmonic currents at levels which cause unacceptable degradation of the mains environment. This directly contributes to meeting compatibility levels established in other EMC standards such as IEC 1000-2-2, which defines compatibility levels for low-frequency conducted disturbances in low-voltage supply systems.

The block diagram in Figure 12 illustrates the equipment functions required to implement tests per the IEC 1000-3-2 and EN 61000-3-2 standards.

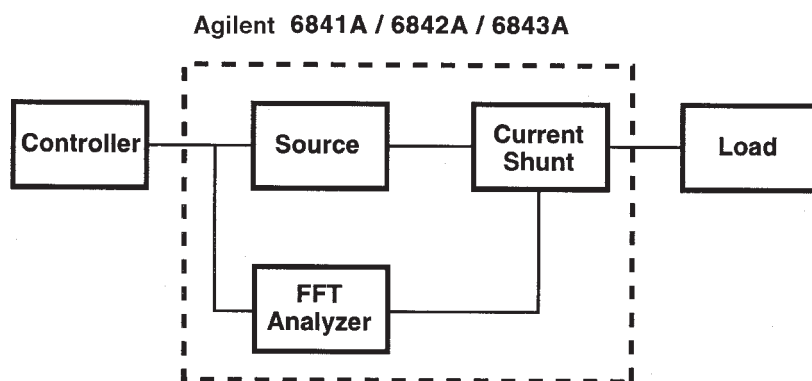

Figure 12. Equipment diagram for testing harmonic current emissions

Class Definition

To establish limits for similar types of harmonic current distortion, equipment under test must be categorized in one of four defined classes. Use the flowchart in Figure 13 to determine equipment classification.

Class A: Balanced three-phase equipment, and all other equipment except that stated in one of the remaining three classes.

Class B: Portable electrical tools, which are hand held during normal operation and used for a short time (a few minutes) only.

Class C: Lighting equipment, including dimming devices.

Class D: Equipment having an input current with a “special wave shape” (e.g., equipment with off-line capacitor-rectifier ac input circuitry and switch-mode power supplies) and an active input power ≤ 600 W. The active power is defined as Watts. For the Class D mA/W limits to apply, the active power must also be greater than 75 W. This lower limit will be reduced to 50 W within 4 years of the implementation of IEC 1000-3-2. Note that the standard is ambiguous as to whether or not the maximum permissible harmonic current limits of the standard (see Table 3, page 15) apply to devices with active power below these thresholds.

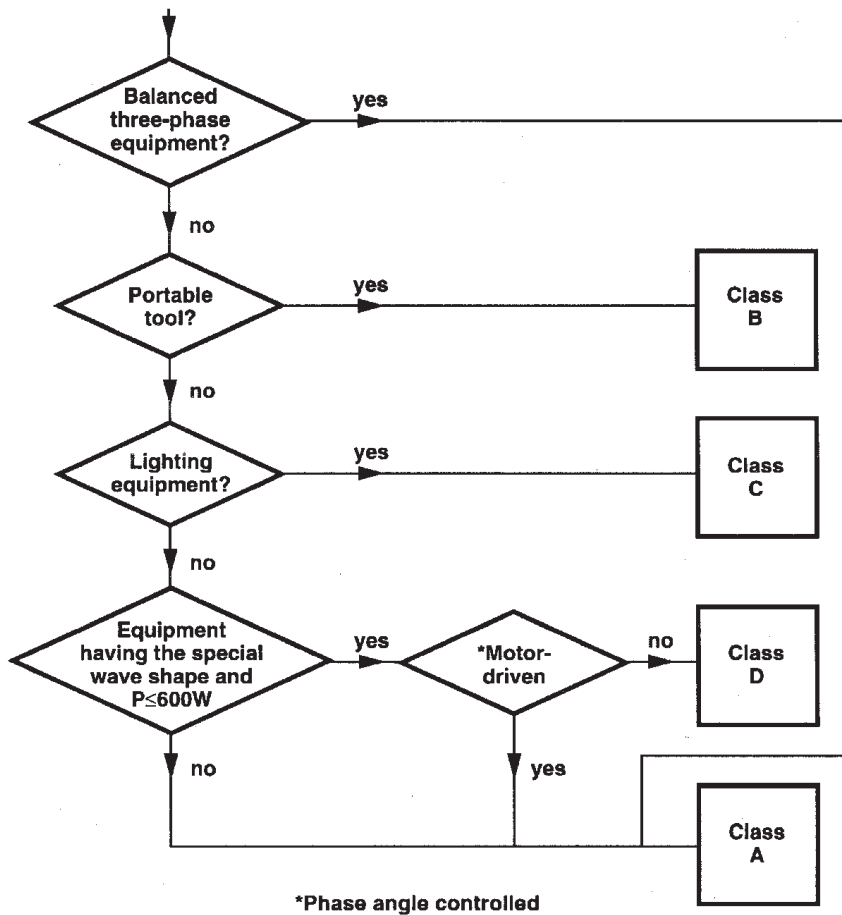

Figure 13. Flowchart for class determination

Class D Equipment

For electronic equipment to be classified as Class D, two requirements must be met, assuming the equipment does not meet the definition of the other three classes. The first requirement, as previously discussed, is that the active input power of the equipment must be ≤ 600 W. The second requirement according to IEC 1000-3-2 states that:

“equipment shall be deemed to be Class D if under the test conditions given in Annex C, the input current waveshape of each half-period—referred to its peak value i_{pk} —is within the envelope shown in the following figure for at least 95% of the duration of each half period; this implies that waveforms having small peaks outside the envelope are considered to fall within the envelope. The center line M, coincides with the peak value of the input current.”

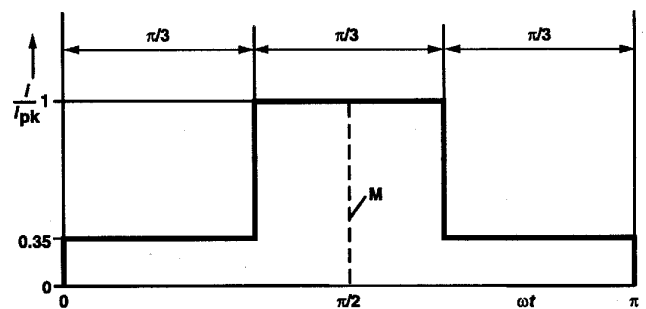

Figure 14. Class D waveshape envelope

Test Limits

The following tables describe the test limits for harmonic currents according to class. Harmonic current limits are noted for Class A, C, and D equipment in Tables 1, 2, and 3, respectively. The limits for Class B equipment are 1.5 times those for Class A.

Table 1. Limits for Class A Equipment

Harmonic order (n)	Maximum permissible harmonic current (A)
Odd Harmonics	
3	2,30
5	1,44
7	0,77
9	0,40
11	0,33
13	0,21
$15 \leq n \leq 39$	$0,15 \times 15/n$
Even Harmonics	
2	1,08
4	0,43
6	0,30
$8 \leq n \leq 40$	$0,23 \times 8/n$

Table 2. Limits for Class C Equipment

Harmonic order (n)	Maximum permissible harmonic current expressed as a percent of the input current at the fundamental frequency (%)
2	2
3	$30 \cdot \lambda^*$
5	10
7	7
9	5
$11 \leq n \leq 39$ (odd harmonics only)	3

* λ is the circuit power factor.

Table 3. Limits for Class D Equipment

Harmonic order (n)	Maximum permissible harmonic current per watt (mA/W)	Maximum permissible harmonic current (A)
3	3,4	2,30
5	1,9	1,14
7	1,0	0,77
9	0,5	0,40
11	0,35	0,33
$13 \leq n \leq 39$ (odd harmonics only)	$3,85/n$	See Table 1

The general harmonic test limits are as follows:

- Harmonic currents <0.6% of the input current or less than 5 mA are disregarded.
- If the envelope of the spectrum of harmonics 20 through 40 decrease monotonically, only harmonic 2 through 19 need to be measured.
- For fluctuating (or transitory) even harmonics from 2 through 10 and odd harmonics from 3 through 19, harmonic amplitudes can be 1.5 times the limits for 15 seconds of any 2.5 minute period.

The IEC 1000-3-2 and EN 61000-3-2 standards describe harmonic measurement test conditions only for some types of equipment. The objective is to test all applicable equipment under conditions that produce the maximum harmonic amplitudes under normal operating conditions for each harmonic component. A critical element for successful compliance testing is the quality of the ac power source and harmonic measurement instrumentation.

AC Power Source Requirements

In general, the ac power source used for testing equipment to the harmonic current emissions limits must have low output impedance to minimize output voltage distortion, sufficient output voltage ratings to supply the appropriate test voltages, peak current ratings sufficient to power the equipment under test without clipping, and the ability to sufficiently regulate the output voltage, frequency, and phase relationship (for three phase testing). The specific requirements are:

Output voltage ratings:	230 Vrms (single-phase) 400 Vrms (three-phase)
Voltage and frequency accuracy:	230 Vrms $\pm 2\%$, 50 Hz $\pm 0.5\%$
Phase angle accuracy:	120° $\pm 1.5^\circ$ between the fundamental voltage of each phase
Harmonic content of the output voltage (% of $V_{\text{fundamental}}$):	0.9% (3rd harmonic) 0.4% (5th harmonic) 0.3% (7th harmonic) 0.2% (9th harmonic) 0.1% (even harmonics from 2 to 10) 0.1% (all harmonics from 11 to 40)
Peak output voltage value:	1.40 to 1.42 times the rms value reached within 87° to 93° after the zero crossing

Harmonic Current Measurement Requirements

The scope of the harmonic emissions standards include measurement requirements for both quasi-stationary (steady-state) and fluctuating harmonics. The methodology and limits used to measure harmonic levels for compliance is dependent upon which type of harmonics are generated by the equipment under test. Annex B of IEC 1000-3-2 and IEC 1000-4-7 jointly describe a number of requirements for instrumentation used to measure harmonic currents in ac mains circuits. Sections B.1, B.2, and B.4 are applicable to the FFT implementation used in Agilent's 6840 Series Harmonic/Flicker Test System. Figures 15 and 16 illustrate the measurement circuits for single-phase and three-phase equipment according to IEC 1000-3-2 and EN 61000-3-2 (Annex A).

The IEC 1000-4-7 standard defines harmonic current measurement instrumentation in terms of accuracy class (A or B) and signal characteristics of the measured parameter (quasi-stationary or fluctuating). Class A accuracy levels are required for compliance-level harmonic current measurements.

General measurement guidelines are specified for the test conditions defined in Annex C of the standards or user-defined test conditions that generate worst case harmonic levels (either quasi-stationary or fluctuating harmonics). The objective of IEC 1000-3-2 and EN 61000-3-2 is to test equipment under normal operation, and therefore current inrush conditions that typically occur when equipment is first powered up or powered down are disregarded. A wait period of ≤ 10 seconds is specifically called out in the fluctuating (transitory) harmonic measurement requirements. General harmonic measurement requirements are as follows:

- The total measurement error for steady-state harmonics shall not exceed 5% of the permissible limits or 0.2% or the rated current of the EUT.
- The input impedance of the measuring instrument (e.g., a current shunt) shall be such that the voltage drop across the input circuit shall not exceed 0.15 Volts peak.
- In the case of fluctuating harmonics, a smoothing filter having a response equivalent to a first order lowpass filter with a time constant of 1.5 seconds $\pm 10\%$ shall be applied to the DFT outputs.

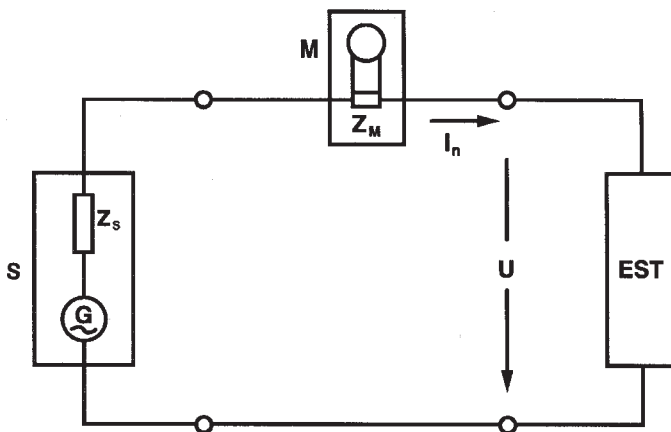

Figure 15. Single-phase measurement circuit

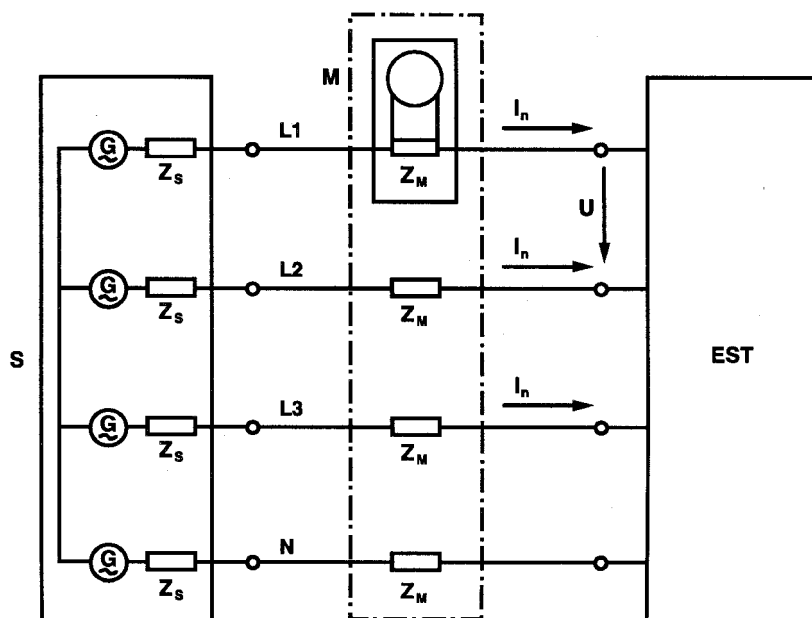

Figure 16. Three-phase measurement circuit

IEC 1000-3-3 and EN 61000-3-3

The IEC 1000-3-3 and EN 61000-3-3 standards define the measurement requirements, ac power source requirements, line impedance requirements, and voltage fluctuation and flicker limits for assessing electronic and electrical equipment's propensity to cause voltage disturbances on the ac mains. Compliance with these standards ensures that voltage fluctuations do not interfere with other equipment connected to the ac mains or cause incandescent lights to visibly *flicker* in a way that causes an annoyance or health risk to a human observer.

The amplitude and frequency of occurrence of these voltage fluctuations directly determine the level of flicker perceived by the human observer. Figure 17 is a representative curve showing the

relationship between relative amplitude changes, $U(t)/U_n$, versus frequency of occurrence for a constant level of flicker irritability, or Pst. The flicker measurement requirement of these standards, therefore, quantifies the annoyance a typical human would experience due to voltage fluctuations in terms of amplitude and frequency. Common sources of flicker are equipment that produce time-varying loading conditions. Some specific examples are hot plates, microwave ovens, and laser printers.

The block diagram in Figure 18 illustrates the equipment functions required to implement the IEC 1000-3-3 and EN 61000-3-3 standards.

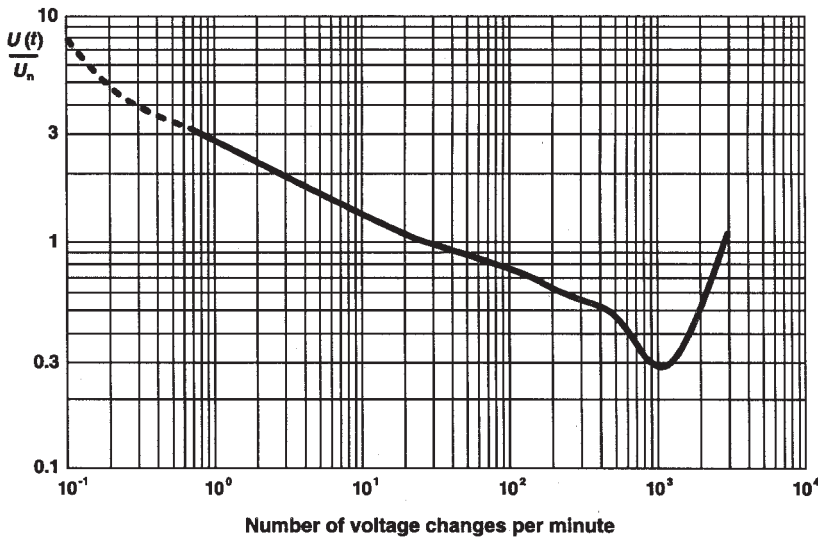

Figure 17. Representative Pst = 1 curve

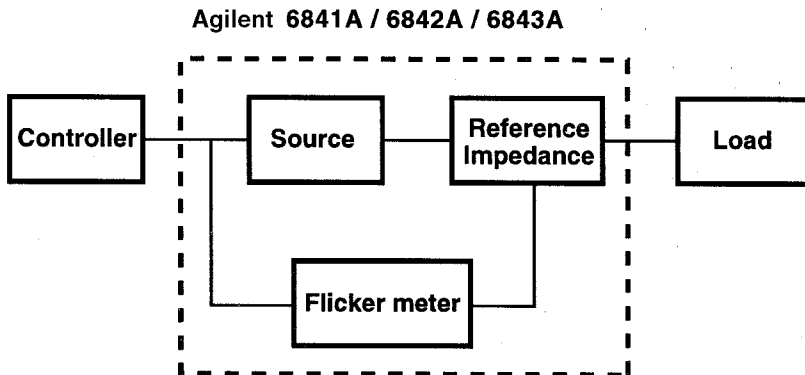

Figure 18. Equipment diagram for testing voltage fluctuations and flicker

Test Limits

Compliance is determined if the following test parameters are within the following defined limits:

Short-term Flicker (Pst): The flicker severity evaluated over a short period of time (10 minutes). Pst = 1 is the conventional threshold of irritability, and therefore the limit.

Long-term Flicker (Plt): The flicker severity evaluated over a long period (typically 2 hours) using successive Pst values. Plt = 0.65 is the conventional threshold of irritability, and therefore the limit.

For voltage changes that are caused by manual switching of equipment or that occur less frequently than once per hour, Pst and Plt are not applicable. However, the following voltage change (“D”) parameters are applicable, with the limits multiplied by 1.33.

Relative Steady-state Voltage Change (Dc): The difference between two adjacent steady-state voltages relative to the nominal voltage. Dc must be $\leq 3\%$.

Relative Voltage Change Characteristic (D(t)): The change in rms voltage, relative to the nominal voltage, as a function of time and between periods when the voltage is in a steady-state condition for at least 1 second. D(t) must not be $> 3\%$ for more than 200 milliseconds continuously during a voltage change event.

Maximum Relative Voltage Change (Dmax): The difference between maximum and minimum rms values of the voltage change characteristic relative to the nominal voltage. Dmax must be $\leq 4\%$.

AC Power Source Requirements

Since flicker is determined by monitoring voltage changes, requirements for these standards include making measurements when the equipment under test is powered through a specified line or reference impedance. This reference impedance is defined according to IEC 725. For 230 V/50 Hz power distribution systems, the reference value is $0.4 + j 0.25 \Omega$ (phase to neutral).

Traditionally, this reference impedance (series Resistor and Inductor) is provided as a separate box that is connected between the ac source and the equipment under test as shown in Figure 19. Some ac source equipment has built-in source impedance control, but only the Agilent 6840 Series Harmonic/Flicker Test System has the accuracy to provide a true compliance-level reference impedance.

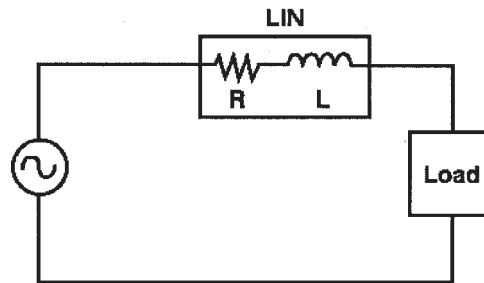

Figure 19. Source with additional R and L (LIN) and load

Other ac power source requirements are:

Output voltage ratings:	230 Vrms (single-phase) 400 Vrms (three-phase)
Voltage and frequency accuracy:	230 Vrms $\pm 2\%$, 50 Hz $\pm 0.5\%$
Voltage THD:	3%
Maximum source short-term flicker (Pst):	0.4

Voltage Fluctuations/Flicker Measurement Requirements

The measurement of the rms voltage fluctuations on the ac mains caused by the equipment under test is the basis for flicker measurements. There are different methods of evaluating flicker severity (Pst) that range from direct measurement via a device called a UIE/IEC flickermeter to the use of mathematical analysis or a Pst graph provided by the standard. The direct method using the UIE/IEC flickermeter is the reference method for true compliance-level testing. This instrument must comply

with the specifications given in the IEC 868 reference standard. This is the method used in Agilent's implementation. A detailed discussion of Agilent's implementation of the UIE/IEC flickermeter is covered under "Implementation of IEC 1000-3-3 and EN 61000-3-3 Standards."

Measurement of voltage fluctuations is also a critical part of determining if electrical equipment causes excessive voltage disturbances on the ac mains. While flicker measurements provide an accurate assessment of the effect of continuous voltage changes, the voltage fluctuation measurements provide a better indication of the effect of sudden large voltage changes. Both can be visibly annoying and detrimental to other loads connected to the same branch circuit. The relative voltage changes must be measured with a total accuracy better than $\pm 8\%$.

The Agilent 6840 Series Harmonic/Flicker Test System Solution

Finding a testing solution that truly meets the requirements of the IEC 10003-2 and 1000-3-3 standards can be a time-consuming and costly process. This process requires full understanding of the standards, the evaluation of multiple test instruments for compliance to the performance and implementation criteria, hardware system integration, and software development. An additional complicating factor can be unclear specifications and poor or misleading documentation from test equipment vendors. The alternative turnkey test systems are often very costly. They typically include the instruments from multiple vendors, some of which would fail to withstand technical scrutiny if evaluated as individual components. These problems have inspired Agilent Technologies to introduce a revolutionary testing solution specifically designed for testing to the new ac mains emission standards called the 6840 Series Harmonic/Flicker Test System.

Procuring a solution is now simple and affordable with the 6840 Series Harmonic/Flicker Test System. Three single phase models are available, the 6841A, 6842A, and 6843A. Power levels range from 750 VA up to 4800 VA, the maximum required by the standards (230 Vrms, 16 Arms). These complete solutions are backed by proven Agilent expertise in power generation, precision measurement, and high quality products.

The Agilent 6840 Series Harmonic/Flicker Test System provides compliance-level testing using reference methodologies for the following ac mains harmonic current, voltage fluctuation, and flicker regulatory standards.

- IEC 1000-3-2 (1995) and IEC 555-2 (1982)
- IEC 1000-3-3 (1994) and IEC 555-3 (1982)
- EN 61000-3-2 (1995) and EN 60555-2 (1987)
- EN 61000-3-3 (1995) and EN 60555-3 (1987)

Test equipment evaluation, system integration time, and equipment cost is greatly reduced with these “One-Box” test systems. Each model is a complete solution with hardware and software, eliminating the need for a separate ac source, line impedance network (LIN), power analyzer, and flickermeter. This saves you the time it takes to specify, rack mount, cable, and develop software for separate instruments. System costs are greatly reduced since you don’t have to purchase expensive instruments, upgrades to the required performance levels, or costly preconfigured multiple box test systems.

Low distortion power generation, low and programmable output impedance, and an accurate measurement system assure compliance-level performance. The 6841A, 6842A, and 6843A were designed according to the reference methodologies outlined in the standards for voltage and harmonic current measurement techniques (IEC 1000-3-2 and IEC 1000-4-7), flicker measurements (IEC 868), and reference impedance requirements (IEC 725). This eliminates the need to spend time and effort comprehending the complexities of the standards and allows you to spend more time testing your equipment.

Each 6840 Series Harmonic/Flicker Test System is shipped with Harmonic/Flicker Test System (HF^{TS}) software for Windows, providing a fast and easy way to access the IEC testing capabilities. The HF^{TS} software provides the following capabilities:

- Test set-up and execution
- Pre-test for EUT (equipment under test) class determination (IEC 1000-3-2)
- Real-time test data display (graphical and tabular)
- On-line/off-line test data review with user-specified search criteria
- Test termination under user-defined conditions
- Pass/Fail indication
- Diagnosis of test results via advanced features
- Report generation

Basic Measurement Definitions

The Agilent 6840 Series Harmonic/Flicker Test System relies on simultaneous digitization of output voltage and current waveforms with subsequent digital processing as the basis for all measurement functions. Voltage and current waveforms are digitized at a 38.4 kHz rate with the digitized samples accumulated into 4K data buffers.

Sampling A/D converters with 16-bit resolution are used to provide superior measurement resolution and tight synchronization between the voltage and current data records. Synchronization is maintained to within a few nanoseconds. Synchronization of measurement windows to the input waveforms is also carefully controlled, as described later in this document. In IEC measurement mode, processing of voltage and current buffers involves the use of FIR (finite impulse response) implemented multi-rate filters to lower sampling rates to frequencies compatible with specific IEC requirements for harmonic and flicker measurements. Options for selecting Rectangular or Hanning windows are provided.

The computational algorithms used for basic voltage, current, and power measurement functions and for the windowing functions are as follows:

$$V_{rms} = \sqrt{\frac{1}{4096} * \sum_{i=0}^{4095} (v_i)^2 * w_i}$$

$$I_{rms} = \sqrt{\frac{1}{4096} * \sum_{i=0}^{4095} (i_i)^2 * w_i}$$

$$Watts = \frac{1}{4096} * \sum_{i=0}^{4095} v_i * i_i * w_i$$

$$VA = V_{rms} * I_{rms}$$

$$PF = \frac{Watts}{VA}$$

$$w_i = 1 \text{ for Rectangular windows}$$

$$w_i = \cos\left(\frac{i}{4096} \pi - \frac{\pi}{2}\right)^2 \text{ for Hanning windows.}$$

Interpretive Issues for Test Solutions Vendors and Equipment Manufacturers

Regulatory testing presents unique challenges that are equally troublesome for vendors of test solutions as they are for equipment manufacturers seeking to certify their products for sale into markets where demonstration of compliance is required. Not only are standards such as IEC 1000-3-2 and IEC 1000-3-3 difficult to understand, but careful reading reveals that what is not said is frequently as important as what is said. In addition, the standards sometimes impose apparently contradictory requirements, and in some cases contain errors, despite the best efforts of competent, dedicated people serving on the standards committees.

Fortunately for equipment manufacturers, most of the interpretive burden falls upon the solutions vendor. Equipment manufacturers need to be aware of the issues and the tradeoffs that have been made, but generally do not need to trouble themselves with discovering and proving that a particular interpretation results in an implementation that cannot be made to work. This section describes the issues in a general way, with examples that apply to both standards. More detailed discussions of issues specific to each standard and Agilent's solutions for these issues may be found under the appropriate standard as discussed later in this document.

Normative References and Their Scope

As previously stated, IEC 1000-4-7 is one of the normative references for IEC 1000-3-2, while IEC 725 and IEC 868 are normative references for IEC 1000-3-3. A normative reference may refer to another standard or it may be a self-contained annex. The "normative" designation means that the reference includes requirements that must be met for compliance. The other possible designation for a reference is "informative," which means that the reference contains useful information related to the standard, but that the material is not a compliance requirement.

When interpreting the impact and scope of normative references, a general rule that may be applied is that the most specific standard carries the greatest weight when evaluating the applicability of requirements in normative references, particularly if any of the requirements appear to conflict with the more specific standard.

As an example of how this rule applies, consider the following: IEC 1000-4-7 is a general reference that documents requirements for instrumentation and measurement techniques to be used for assessing mains circuit harmonic and interharmonic signals. Interharmonics are signals occurring at frequencies other than integer multiples of the mains frequency. Since voltage and current measurements are both described, a plausible interpretation is to conclude that instrumentation used to provide compliance testing for a standard that references IEC 1000-4-7 must comply with all of the requirements documented in IEC 1000-4-7. However, Section 4 of IEC 1000-4-7 clearly states otherwise:

"The instrumentation may be constructed either to cover a particular need and application (e.g., steady-state harmonics on the supply voltage) or to comply with the requirements for several cases (e.g., voltage and current measurements, harmonics and interharmonics)."

IEC 1000-3-2 describes limits for harmonic currents only; **voltage harmonics are not regulated by the standard nor is there any discussion or regulation of interharmonics**. Using the rule that the most specific standard is given greatest weight, an instrument that meets just those IEC 1000-4-7 requirements that apply to harmonic current measurement provides a fully compliant test solution for IEC 1000-3-2, assuming that it also meets all of the requirements of IEC 1000-3-2 itself. This latter point is important. Normative Annexes A and B to IEC 1000-3-2 impose, respectively, requirements for the measurement circuit and supply source and for the measurement equipment. These additional requirements must be met, and in cases where differences exist with respect to requirements described in IEC 1000-4-7, the requirements in the annexes take precedence.

Stated, Implied, and Inferred Requirements

A related set of issues involves recognition of the distinctions between stated, implied, and inferred requirements. Consider the example of voltage distortion monitoring for IEC 1000-3-2.

Section A.2 from Annex A of IEC 1000-3-2 documents a set of requirements for the quality of the mains source to be used during tests which include: accuracy specifications for mains voltage amplitude and frequency, permissible harmonic content of the mains source voltage on a harmonic-by-harmonic basis, and the crest-factor of the voltage waveform. The standard also states that these conditions must be met *“with the EUT connected as in normal operation.”* (EUT stands for equipment under test.) These are the **stated** requirements.

Even though it is not explicitly stated, the language described above clearly **implies** that the specified voltage distortion should be maintained throughout the test, and this is indeed the widely accepted interpretation. In other words, the accepted interpretation is that the standard **implies a requirement** that the specified voltage distortion be maintained throughout the test and that some evidence that this condition is met should be provided.

The next interpretive step is to **infer** that the standard requires continuous monitoring of voltage harmonics throughout the test. This is absolutely not stated, and the inference is not valid. While at first glance it may seem desirable to have this capability, this view does not necessarily withstand scrutiny, particularly if the function adds significant cost or complexity to the test equipment or process without adding any real value. Such an interpretation on the part of the solutions vendor may also entail design tradeoffs that compromise performance for the task immediately at hand by diverting instrument resources towards activities that are not required. If a test scenario can be devised that can guarantee worst-case equipment-under-test behavior, such a scenario would be repeatable, in which case **simultaneous monitoring of voltage and current throughout** the test is clearly not needed to prove that the voltage distortion specification is met. Separate test runs will also provide the necessary proof, and the resulting efficiencies may help optimize the value of the solution.

It is worth noting at this point that the perspectives of IEC solutions vendors and that of equipment manufacturers seeking to demonstrate compliance may differ considerably on **inferred** requirements. From the perspective of the solutions vendor, some requirement overkill may be desirable, particularly if there is any serious doubt about the nature of a valid interpretation. Less positively, overkill may also be desirable by letting a solutions vendor introduce a “lockout” specification that confers a competitive advantage or justifies a high price for the solution.

From the perspective of the equipment manufacturer, the entire compliance process is a cost, with the minimization of cost being the goal. This is not to say that the manufacturer does not recognize the appropriateness of the standard and its value in promoting a quality mains environment. Competent manufacturers seek to improve efficiencies and minimize costs wherever possible as a normal part of conducting business wisely. Opportunities to minimize the cost of compliance testing include controlling the cost of capital expenditures for test equipment, the cost associated with maintaining test labs and staff, and the hourly cost of conducting the tests themselves.

As both a manufacturer of a broad range of equipment that must comply with EMI/RFI standards such as IEC 1000-3-2 and IEC 1000-3-3, and as a vendor of test solutions for demonstrating compliance, Agilent is uniquely positioned to appreciate the perspective of the equipment manufacturer as well as that of the solutions vendor. By keeping the equipment manufacturers perspective foremost in mind, it is Agilent’s belief that the interests of the broadest range of actual and potential customers for EMI/RFI solutions will be best met. This means carefully controlling the impulse to infer requirements that do not actually exist.

Appropriateness of Requirements

Issues of appropriateness constitute another general concern that frequently arises when interpreting standards such as IEC 1000-3-2 and IEC 1000-3-3. Although not limited to this area alone, many appropriateness issues are related to performance of the mains source. This situation is in part due to the history of mains testing. It is only a recent development that power amplifiers have been substituted for use of the local utility (perhaps conditioned by impedance networks and/or crude regulators). The standards still reflect the earlier environment where external disturbances to utility power had to be monitored during a test to ensure that the results were valid. Typically there was little or no ability to correct improper source behavior and the test was simply repeated if the source was shown to be out of specification during the test.

The language in Section 6.3 of IEC 1000-3-3 provides a good example of appropriateness related to the performance of the mains source:

“Fluctuations of the test supply voltage during a test may be neglected if the Pst value is less than 0.4. This condition shall be verified before and after each test.” (Pst is short-term flicker severity.)

This requirement is interesting in several respects. First, it does not provide for continuous monitoring of the source during the test, a fact that has already been discussed earlier under “Stated, Implied, and Inferred Requirements.” Secondly, the statement implies that source voltage fluctuations should be expected. This is an artifact of the history of using utility power as the source. Third, since other language in the same section makes reference to the “*open circuit voltage*,” some solutions vendors have inferred that source flicker must be verified on the source side of the reference impedance. It is not clear that this is the only valid interpretation.

When the test solution includes a high performance source such as is provided in Agilent's 6840A Series Harmonic/Flicker Test System, all of the conditions described in Section 6.3 may easily be guaranteed by design. In this situation, the requirement for verifying $P_{st} < 0.4$ before and after each test is unnecessary. In fact, not only is verification unnecessary, but the performance of the source guarantees that the conditions will always be met throughout the entire test, something that is not guaranteed by pre- and post-test verification.

Verification may still be performed, however. Since the reference impedance of the 6840 Series Harmonic/Flicker Test System is loop implemented (i.e., there is no physical inductor or resistor), verification may be performed by disconnecting the equipment under test, which provides verification on the load side of the reference impedance. As an alternative, the reference impedance may be programmed to its minimum value ($0.0 + j 0.0063$ ohms) with the equipment under test still connected, thus providing verification on the source side of the reference impedance. Note that this latter technique is very conservative since there is no impedance to limit the current drain of the equipment under test and thus the source is potentially subjected to higher currents than otherwise would be the case.

In either case, tests conducted by Agilent show that typical source P_{st} values of 0.07 are obtained with equipment under test exhibiting failing P_{st} values well above the P_{st} limit of 1.0. The results are similar regardless of which verification method is used. The equipment under test used for this test was a 5 V, 100 A switch-mode power supply without power factor correction that was subjected to a 0 to 100

ampere DC load chopped at 9 Hz. Under these conditions, the test unit draws 1640 VA and 800 Watts with a mains peak current of 27 amperes at 230 VAC. The 1750 VA model 6842A Harmonic/Flicker Test System was used to conduct the test. The amplifier within the 6842A maintained source voltage THD at 0.41 % under these loading conditions.

In the immediate future, verification may be routinely performed in order to meet the letter of the standard, but the requirement is clearly inappropriate when a properly designed high performance source is used in place of utility power. The user may wish to consider appropriateness when planning verification tests and may reasonably expect that this requirement will be eliminated at some time in the future as the use of high performance sources becomes commonplace.

Technical Errors

One of the most difficult aspects of correctly interpreting IEC 1000-3-2 and IEC 1000-3-3 involves the presence of technical errors. The entire burden of identifying errors and documenting them for the benefit of users properly falls upon the solutions vendor. This is a key part of the value that a competent solutions vendor provides. A number of these issues as they specifically relate to the IEC 1000-3-2 and IEC 1000-3-3 standards are documented in this application note under the appropriate standard. Again, there is a need to point out that the existence of errors is natural given the complexity of the standards and the manner in which they have evolved; there is no implied criticism of the IEC committees. The following example of sliding mean filters should help illustrate the subtle nature of technical errors in the IEC standards.

Sliding mean filters are mentioned in both IEC 868, which describes requirements for flickermeters, and in working documents from SC 77A/WG01/TF02, which is an IEC committee developing future revisions to IEC 1000-4-7. In both cases, the language used tends to treat “first order lowpass,” “sliding mean,” and “moving average” as interchangeable terms. The language in Section 3.9 of IEC 868 is particularly explicit about this interchangeability in specifying the smoothing filter located at the input to the statistical classifier block (Block 5) of the IEC/UIE flickermeter.

“The sliding mean operator shall have the transfer function of a first order low-pass resistance/capacitance filter with a time constant of 300 ms.”

Figure 20, which displays the frequency response characteristics of an IIR (Infinite Impulse Response) implementation of a first order RC lowpass and a sliding mean filter tuned to the same 3 dB frequency, shows why this language is especially troublesome.

For frequencies at or below the 3 dB point, the two filters exhibit very similar although not identical behavior. At higher frequencies, however, the sliding mean filter shows a series of null responses at frequencies having periods equal to $1/N$ times the filter’s period of 838 ms where N is an integer. Note that a period of 838 ms “tunes” the sliding mean filter for a 3 dB corner frequency equivalent to that provided by the 0.3 second time constant specified for the RC filter. The null responses provide essentially “perfect” filtering of AC signals at these frequencies.

The statistical processing that follows the smoothing filter in a UIE flickermeter makes it difficult to achieve an intuitive understanding of how null responses exhibited by the sliding mean filter impact instrument performance. Tests conducted during the development of the 6840 Series Harmonic/Flicker Test System showed that test frequencies close to the null frequencies yielded improper responses with a sliding mean filter implementation, but not with an equivalent IIR lowpass design.

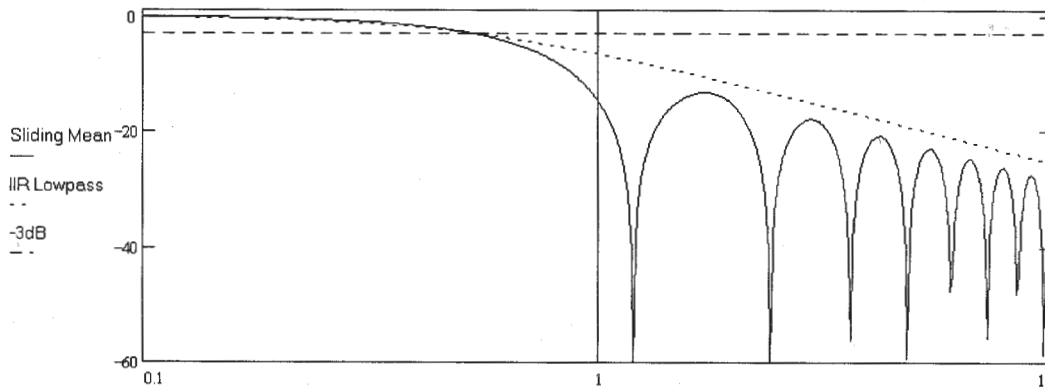

Figure 20. Frequency response of IIR filters versus sliding mean filters

For harmonic testing, the relative behavior of the two filter implementations is as follows: The filter in question here is the 1.5 second smoothing filter used to lowpass filter DFT outputs for fluctuating harmonics prior to comparison with the test limits. Consider a load that exhibits one or more fluctuating harmonics with a 50% duty cycle (i.e., a load with squarewave modulation). Assume also that the load fluctuates between 20% and 160% of the specified limit for a given harmonic at a frequency exactly equal to one of the null frequencies exhibited by the sliding mean filter. The null response will average these fluctuations to a non-fluctuating level corresponding to 90% of the specified limit. Under these conditions the equipment under test will pass, but with a slightly different modulating frequency it will fail the 2.5 minute window criteria for fluctuating harmonics, both because individual measurements will exceed 150% of specification and because greater than 10% of the measurements will exceed 100% of the limit. The test could also be misinterpreted as showing quasi-stationary behavior and a false “pass” would still occur. Other scenarios may be devised to produce similar results.

Agilent believes that the IEC committee somehow overlooked this aspect of sliding mean filter performance. For the solutions vendor, the choice is to deviate from a literal interpretation of the standard in favor of a focus on “intent” which clearly dictates use of an IIR implementation. In the case of IEC 868, this decision is made easier by the confusing language quoted above that would appear to make either implementation compliant. If future revisions to IEC 1000-4-7 or IEC 868 specify a “moving average” filter, a more difficult interpretive decision may be required.

Implementation of IEC 1000-3-2 and EN 61000-3-2 Standards

Harmonic Current Measurements

Annex B of IEC 1000-3-2 and IEC 1000-4-7 jointly describe a number of requirements for instrumentation used to measure harmonic currents in ac mains circuits. Sections B.1, B.2, and B.4 are applicable to the FFT implementation used in Agilent's 6840A Series Harmonic/Flicker test systems.

There is language in IEC 1000-4-7 that implies that certain parts of Section B.3, which describes requirements for frequency domain instruments (i.e., wave analyzers), may also be applicable since it is the intent of the standards that time and frequency domain techniques produce equivalent results. In particular, measurement bandwidth and attenuation of adjacent signals in the frequency domain are defined by language in Section B.3. It turns out that using the reference grade methodologies described in Section B.4 for fluctuating harmonics (i.e., rectangular windows without overlap and 16 cycles of the fundamental within the measurement window) meets the bandwidth and attenuation requirements of Section B.3. The key requirements for harmonic current measurement are summarized as follows:

- The total measurement error for steady-state harmonics shall not exceed 5% of the permissible limits or 0.2% of the rated current of the EUT.
- For steady-state (i.e., quasi-stationary) harmonics the width of the measuring window shall be between 4 and 30 cycles of the fundamental.
- For steady-state harmonics, either Hanning or Rectangular windows may be used. There is no specification for gaps or overlaps.
- For fluctuating harmonics, either Hanning or Rectangular windows may be used. The use of Rectangular windows requires no gaps or overlaps, while the use of Hanning windows requires 50% overlap.
- In either case, use of Rectangular windows requires synchronization of the measuring window to the mains frequency to 0.03% or better.
- When test limits are exceeded (*i.e., when the test results are close to the limits*), either a Rectangular window or a Hanning window may be used with the additional requirement that 16 (Rectangular) or 20-25 (Hanning) cycles of the fundamental shall appear in the measuring window.
- The input impedance of the measuring instrument (e.g., a current shunt) shall be such that the voltage drop across the input circuit shall not exceed 0.15 Volts peak.
- In the case of fluctuating harmonics, a smoothing filter having a response equivalent to a first order lowpass filter with a time constant of 1.5 seconds $\pm 10\%$ shall be applied to the DFT outputs.

Additionally from Section B.3:

- When test limits are exceeded (*i.e., when the test results are close to the limits*), an instrument shall be used with a bandwidth of 3 Hz ± 0.5 Hz.

Agilent 6840 Series Measurement Accuracy

The harmonic current measurement accuracy for the 6840 Series Harmonic/Flicker Test System is summarized in the following table:

	6841A	6842A	6843A
Fundamental (Low Range)	0.03% + 1.5 mA	0.03% + 1.5 mA	0.03% + 3 mA
Harmonics 2-40 (Low Range)	0.03% + 1 mA + 0.2%/kHz	0.03% + 1 mA + 0.2%/kHz	0.03% + 2 mA + 0.2%/kHz
Fundamental (High Range)	0.05% + 5 mA	0.05% + 5 mA	0.05% + 6 mA
Harmonics 2-40 (High Range)	0.05% + 3 mA + 0.2%/kHz	0.05% + 3 mA + 0.2%/kHz	0.05% + 3 mA + 0.2%/kHz

The 6840 Series Harmonic/Flicker Test System uses a base digitization rate of 38.4 kHz for all combinations of mains frequency and window type. FIR (Finite Impulse Response) implemented multirate digital filtering techniques are used to lower the sampling rates to frequencies compatible with acquisition of 4K data buffers having measurement windows (i.e., acquisition windows) consistent with stated requirements for the number of fundamental cycles to be contained within the measurement window.

Note that the need to perform this sample rate reduction in order to meet the requirements of the standard completely negates claims made by some solutions vendors that 100K+ sample/second digitization rates are required to perform IEC 1000-3-2 tests. What is required is careful design of anti-aliasing filters to ensure that adequate rejection of signals past the Nyquist limit is obtained without compromising measurement accuracy in the dc-to-2 kHz passband.

A 4K FFT (Fast Fourier Transform) is performed regardless of the selection of mains frequency and window type. Note that an FFT technique is used to obtain harmonic data and that this technique is fully compatible with requirements for use of a DFT (Discrete Fourier Transform) despite some confusing of this issue by other solutions vendors. An FFT is simply an algorithm for rapidly computing a DFT that meets certain constraints; the calculation is still a DFT. The relationships between selection of mains frequency and window type and the dependent variables of sampling rate, decimation rate, measurement (acquisition) window period, overlap, record (data) rate, fundamental bin number, bin spacing, and 3 dB bin bandwidth are summarized in the tables below.

Mains Frequency	Window Type	Sample Rate	Decimation Rate	Acquisition Window	Overlap
50 Hz	RECTangular	12.800 kHz	3X	320 ms	None
50 Hz	HANNing	8.533 kHz	4.5X	480 ms	50%
60 Hz	RECTangular	15.360 kHz	2.5X	266.7 ms	None
60 Hz	HANNing	7.680 kHz	5X	533.3 ms	50%

Mains Frequency	Window Type	Record Rate	Bin Number (F1)	Bin Spacing	3 dB Bandwidth
50 Hz	RECTangular	320 ms	16 at 50 Hz	3.125 Hz	2.8 Hz
50 Hz	HANNing	240 ms	24 at 50 Hz	2.083 Hz	3.0 Hz
60 Hz	RECTangular	266.7 ms	16 at 60 Hz	3.750 Hz	3.3 Hz
60 Hz	HANNing	266.7 ms	32 at 60 Hz	1.875 Hz	2.7 Hz

The bin number for the fundamental is the same as the number of cycles of the fundamental frequency contained within the measuring (acquisition) window. Note that for 60 Hz with a Hanning window, the number of fundamental cycles within the window is 32, which would appear to be a violation of the requirements of the standard to have 20 to 25 cycles within the acquisition window when using a Hanning window. In Agilent's view, this is either a minor technical error within the standard or a reflection of the IEC committee's focus on 50 Hz systems. The possible integer range for fundamental cycles consistent with a 3 Hz \pm 0.5 Hz bandwidth (as described in Section B.3 of IEC 1000-3-2) at a mains frequency of 60 Hz is 25 to 34. A very difficult implementation decision would have been required to provide a 25 cycle window and this would have produced a bandwidth of 3.46 Hz, which would have been at the upper limit of the stated range for bandwidth. Given this situation, a decision was made to select 32 cycles with a resulting bandwidth of 2.7 Hz. Agilent's design objective was to use reference level methodologies in all cases. The Rectangular window with 16 cycles is an option if literal compliance is demanded. This would in any case be the proper and recommended choice for those situations where measured values are close to the specified limits.

Measurement Synchronization Using Rectangular Windows

One of the unique performance advantages provided by Agilent's fully integrated solution is elimination of concern about synchronization when using Rectangular windows. Because the output waveform generation and the measurement systems share a common clock, synchronization to better than 0.25 ppm, or 0.000025%, is maintained continuously. In addition, the transient events caused by the response time of the phase- or frequency-locked loops used by alternative solutions can never occur.

Although the technique just described completely solves the synchronization issue for quasi-stationary harmonic tests, neither it nor any other synchronization method completely solves the problems brought about by fluctuating harmonic signals.

Synchronization is a concern when Rectangular windows are used because the extremely poor side-lobe suppression provided by the window permits spectral leakage from nearby bins that can severely corrupt magnitude measurements. This effect is completely eliminated if perfect synchronization is maintained, which is another way of saying that all frequencies present must be harmonics of a base frequency that has an exact integer number of cycles within the measurement window. Normally this base frequency has exactly one cycle within the acquisition window and is equal to $1/T_W$ where T_W is the width of the measurement window. These frequencies correspond to the bin spacing and are shown in the previous tables. The requirement for 16 cycles of the fundamental within the measurement window for IEC 1000-3-2 measurements modifies, but does not undo, the logic of this constraint. Unfortunately, fluctuating harmonics are virtually guaranteed to produce many nonharmonically related frequency components which do not meet this criterion.

The requirement for use of either Rectangular or Hanning windows, with an apparent preference for Rectangular windows, may reflect the IEC committee's awareness that both of these windows, when used with the overlap specified for reference grade measurements, provide unity weighting for each input sample. Despite this unique characteristic (the Triangular window is the only other commonly described window with similar properties), it is generally accepted that other windows offer superior performance for spectral estimation. Requirements for use of Rectangular windows in the presence of fluctuating harmonics may thus be seen as a fundamental technical issue that impacts the performance of any IEC 1000-32 test solution.

The following three figures illustrate the differences in sidelobe performance between Rectangular, Hanning, and KBessel windows.

The IEC committees have been advised of these concerns, and recommendations have been made to the committees for use of other windows that exhibit superior sidelobe performance. Unless the committee concurs and elects to modify the window requirements, solutions vendors have little choice other than meeting the letter of the standard.

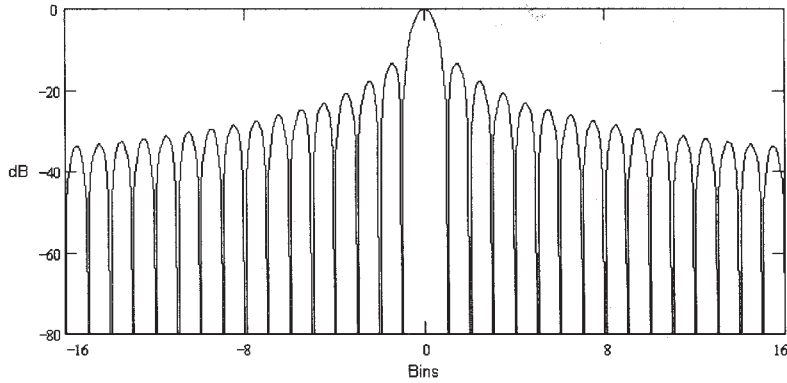

Figure 21. Sidelobe performance for Rectangular windows

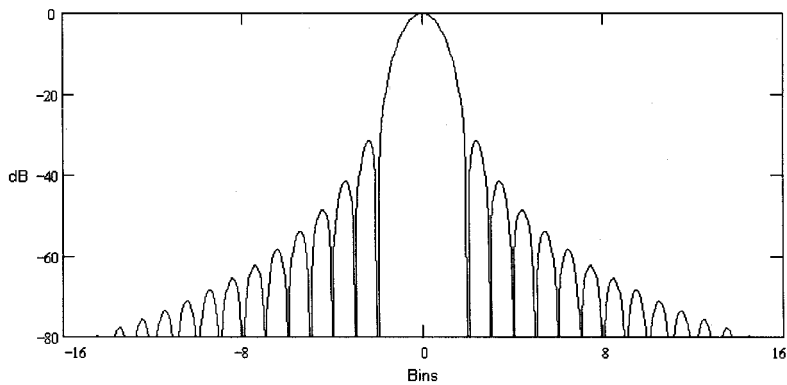

Figure 22. Sidelobe performance for Hanning windows

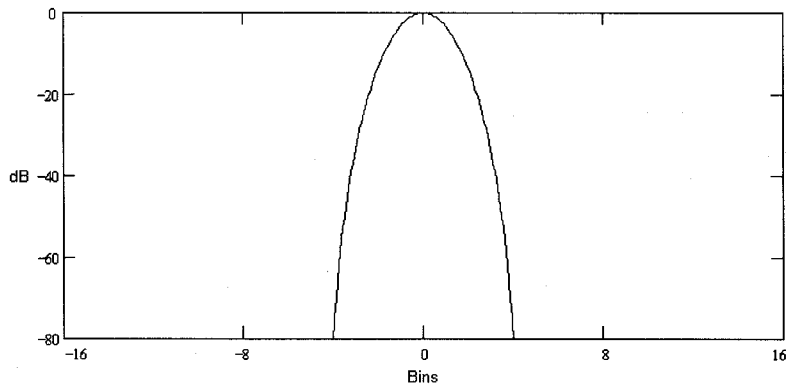

Figure 23. Sidelobe performance for KBessel windows

Shunt Burden

The voltage drop across the measuring instrument input is 0.0 volts for the Agilent 6840 Series Harmonic/Flicker Test System because the regulating loop for the source amplifier senses voltage at the load and thus corrects for any drop across the internal measuring shunt.

1.5 Second Smoothing Filter

An IIR type lowpass filter with a time constant of 1.5 seconds is used to smooth outputs whenever fluctuating harmonic measurements are selected. The time constant for this filter is controlled to better than 0.1%. It may be noted at this point that sliding mean filters, in addition to exhibiting null responses at certain frequencies as previously discussed under “Technical Errors,” also suffer the drawback of having coarse tuning resolution relative to IIR implementations in digital systems when the filter corner frequencies and sampling frequencies are close to one another. This is the case for filtering DFT outputs from IEC 1000-3-2 tests. The effect occurs because the length of the filter becomes shorter as the corner frequency approaches the sample rate. This in turn means that integer steps in filter length have a relatively large impact on tuning. Please note that “close” in this case means ratios of 1:30, not close in the sense that the Nyquist limit is approached.

Source Impedance

Users should be aware that source impedance can dramatically affect the magnitudes of harmonic currents. This situation is sometimes used to an advantage where a marginally passing EUT can be made to pass solidly by slightly increasing the source impedance. More commonly, source impedance variations from one source to another cause measurement correlation problems when different test systems are used. This variability can be particularly frustrating when a marginal EUT unexpectedly fails a test it was thought to pass.

Several things should be kept in mind regarding source impedance. First, users frequently question the accuracy of the measuring equipment when source impedance variability is the real culprit. Secondly, it is unreasonable to expect exact correlation between test systems, particularly if different mains sources are used; lower source impedance will produce higher harmonic currents. Third, source impedance is a function of frequency. This means that identical results may be obtained for some harmonics, even with different sources, but other harmonics may vary considerably. This will be especially true for higher harmonics. Fourth, high source impedance will cause voltage distortion. A harmonic current working against the source impedance will produce a corresponding harmonic voltage. IEC 1000-3-2 indirectly controls source impedance by limiting the permissible levels of output voltage harmonics as documented in Annex A of the standard.

Lastly, IEC 1000-3-2 contains in Figure A.1, the vague statement that source impedance Z_S is not specified, but must be “*sufficiently low to suit the test requirements.*” There is growing recognition that the near-ideal source impedances provided by high performance sources do not accurately replicate typical mains environments. There has been some discussion of adding a requirement for a LIN (Line Impedance Network) that would insert a known source impedance into the measurement circuit. To date no official action has been taken on this issue in Europe although some countries, notably Japan, have added LIN requirements for harmonic current testing.

Presently, Agilent’s design decision is to set the output impedance to the lowest possible level during harmonic tests, but because output impedance is a programmable loop-based implementation in the 6840 Series Harmonic/Flicker Test System, future changes may be easily accommodated via upgrades to the software package included with the system.

Readers interested in this issue may wish to consult IEC 725, which contains the results of a study of mains impedances in most European countries. This study formed the basis for selection of the values used for the reference impedance that is required for flicker testing and may be used as well for justifying inclusion of a LIN for harmonic current testing.

The Pre-Test Window for Class Determination

Agilent's HFTS software application, which is part of the 6840 Series Harmonic/Flicker Test System solution, provides a Pre-Test window that contains controls and displays to facilitate determination of EUT class as well as providing other useful information about EUT and system performance. Frequent references will be made to functions provided in this window. The following figure shows the Pre-Test window, included here to help the reader visualize how these functions may be used as part of a compliance test. As its name implies, the Pre-Test window centralizes functions that, following test setup, need to be performed prior to running an actual test. This includes running preliminary tests to measure quantities that are subsequently used to set test limits for Class C and Class D devices.

Test limits for Class C devices are a function of the power factor (PF) and fundamental current drawn by the EUT, while for Class D devices limits are a function of active power (i.e., Watts) drawn by the EUT. Agilent's general design philosophy has been to provide flexible tools in the Pre-Test and Set-up

windows that simplify measurement of the necessary parameters, confirm user setup decisions, and permit overriding of pre-test results if required. The basic assumption is that users will perform these tasks prior to running the actual compliance test in order to establish uniform test limits for use throughout the subsequent test.

Agilent has taken this position rather than an inferred requirement that for Class D testing in particular, the current waveform must be evaluated continuously for each measurement window during a harmonic current test, with class determination and test limits calculated simultaneously and uniquely for each measurement window. While it may indeed be possible to assemble instrumentation and analysis software to support such an interpretation of the standard, it is difficult to know exactly what value a mass of test data with constantly varying pass/fail limits would be to users. This is particularly true for those attempting to develop a diagnostic perspective on a failed test so that corrective modifications to the EUT might be made.

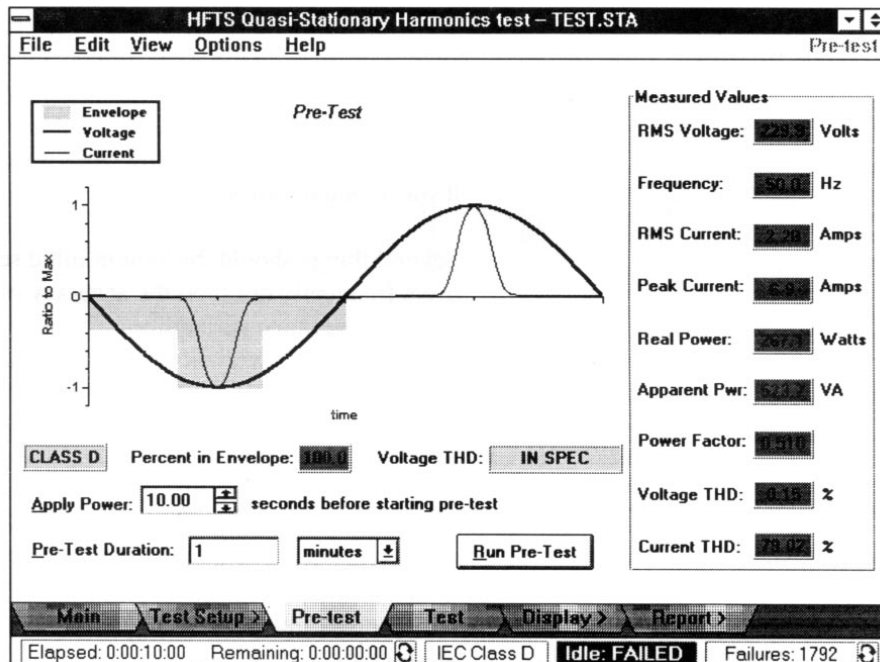

Figure 24. Pre-test window

It is appropriate to ask, what benefit does an extreme and costly interpretation of the standards provide to equipment manufacturers seeking product certification, to solutions vendors seeking to profit by providing test solutions for the equipment manufacturers, or to governmental and quasi-governmental bodies seeking to regulate the mains environment? Equipment manufacturers clearly do not benefit from extreme interpretations that complicate the job of getting products over the regulatory hurdles. Solutions vendors may in some cases find more extreme interpretations to be in their interest, but as the resulting requirements become ever more onerous and the pursuit of “lockout” specifications becomes more obvious, the motives of these solutions vendors become suspect. Regulatory agencies and quasi-governmental bodies such as the power utilities, the drivers behind the standards, seek to promote a “clean” mains environment that minimizes interactions between their customers’ loads. They also wish to promote public safety and transmission efficiencies by discouraging low power factor loads. It is not at all in the interest of these agencies to promote standards that are so stringent that industry either ignores the standards or is aroused to lobby against them.

Class D Active Power Tests and the Special Waveshape Requirement

Certain devices, particularly switch-mode power supplies using off-line conversion technologies, may draw high peak current through a small conduction angle near the peak of the mains voltage waveform. If this characteristic is sufficiently pronounced, IEC 1000-3-2 requires that the EUT be tested as Class D device. Harmonic current limits for Class D devices are a function of the active power drawn from the mains circuit (i.e., Watts), and generally will be lower than those provided for Class A devices. The more stringent requirements

for Class D reflects the higher harmonic content of the current waveform typical for these devices and a corresponding desire on the part of regulatory bodies to control these emissions. Note that all EUT’s that are not portable tools (Class B) or lighting devices (Class C) must be either Class A or Class D devices.

The following criteria must be met before the EUT is classified as a Class D device:

1. The input current waveform must have the “special shape” defined in Figure 1 of IEC1000-3-2.
2. The EUT must not be “... *motor driven equipment with phase angle control* ...”
3. The active input power must ≤ 600 W.
4. For the Class D mA/W limits to apply, the active power must also be greater than 75 W. This lower limit will be reduced to 50 W within four years of the implementation of IEC1000-3-2. As noted earlier, the standard is ambiguous as to whether or not the “*maximum permissible harmonic current*” limits given in Table 3 of the standard apply to devices with active power below these thresholds. Agilent takes the position that these maximum limits do apply, but the user is free to interpret the standard as not requiring a test if this condition is met.

The requirements, while appearing straightforward, actually require some interpretation and considerable care on the part of the test engineer during test setup.

Note that Figure 1 from IEC 1000-3-2, which is duplicated in Figure 14, contains an ambiguity that requires interpretation. The vertical axis is in units of i/i_{pk} , which normalizes the waveform to the peak value and takes the absolute value of the waveform as long as i and i_{pk} are equal in sign. So far, so good! If, however, a small DC component due either to EUT behavior or to offsets in the measurement circuit causes a significant portion of the waveform, typically in the first or last third of the half-cycle, to be opposite in sign to the peak value in the corresponding half-cycle, the requirement that at least 95% of waveform fall within the window will not be met even though the waveform has characteristics that otherwise qualifies the EUT for Class D treatment. This does not seem to be a valid interpretation and Agilent's implementation instead takes the absolute value of the ratio of i to i_{pk} .

The current waveform peak is required to be centered in the Class D envelope for proper evaluation of the 95% criterion. Fitting the current waveform to the Class D envelope may be problematic if a noisy and relatively flat-topped current waveform becomes sufficiently offset in time relative to the envelope to cause misinterpretation. Agilent's implementation makes use of several filtering algorithms to assist in proper location of the peak within the waveform record which is then analyzed without filtering. As a final check, the waveform is actually displayed at high resolution in the Pre-Test window along with the Class D envelope. This enables the operator to visually detect and reject a false test result should one occur.

A second issue, once a Class D determination has been made and confirmed, is the requirement to measure active power in order to set the test limits. The definitions section of IEC1000-3-2 defines active power as: *"The mean value, taken over one period, of the instantaneous power."*

Agilent takes this definition as a statement describing a mathematical relationship between instantaneous values and the range of integration for a meaningful integral of those values, not as a literal statement that ranges of integration must only be one mains period.

Agilent's view is that a tool that integrates power over a user-selected interval of time provides the most appropriate means for measuring active power. This permits the user to adjust the test based on knowledge of the EUT's behavior in manner that best captures its performance under typical usage scenarios. The Pre-Test window provides just such a tool. A "Pre-Test Duration" control permits the user to select pre-test durations ranging from 100 ms to 7 days. Power is averaged for an integer number of mains cycles equal to the duration of the pre-test. This technique provides the user with an accurate measure of the behavior of the load integrated over a period of his choosing. Rms voltage and current are also integrated over this same period, again for an exact integer number of mains cycles. Various calculations for derived parameters such as VA, power factor, etc. are then made and all of this information is displayed for the user.

At the end of the pre-test interval, the current waveform is digitized, filtered, analyzed, and presented against the Class D envelope. A calculation for percent within the envelope is made and the results displayed. The user's tentative class selection made previously in the test setup screens is checked against the results of this calculation and measured active power. The user's selection is then verified within a window that displays the actual class with a green background indicating a confirmed choice and a red background indicating an invalid choice.

Finally, the user is given one additional control in the advanced setup options screen where, at the user's discretion, a choice can be made to override the default mode of automatic Class D limit setting based on the measured active power and instead manually enter the active power to be used in setting limits. Use of this control gives an indication that the test is potentially invalid, but gives the user an additional level of control that may aid diagnostic activities or ease testing of an otherwise problematic EUT.

Laser printers are frequently mentioned as "problem" EUT's. This occurs because these devices typically exhibit both Class A and Class D behavior depending upon their operating mode. When the fuser heater is on, or in some instances when the device is in print mode, Class A waveshapes are present, but in standby mode Class D behavior is usually observed. A case has been made by some observers that this behavior means that laser printers cannot be tested unless instantaneous class changes are permitted during the test. Agilent believes that careful use of the long-term integration tool provided in the Pre-Test window in the context of a Class D test will provide a test that is both reasonable and compliant. Note that the objection that momentary Class A behavior will cause certain failures given the tighter limits imposed by Class D testing does not hold up; the currents drawn during these periods are primarily fundamental currents and **there is no limit specified** for fundamental current in any class.

Class C Power Factor and Fundamental Current Measurement

The controls and displays provided in the Pre-Test window may also be used to set limits for Class C devices. As mentioned previously during the discussion of Class D devices, rms voltage, rms current, and active power (Watts) are integrated over the entire duration of the pre-test. Since VA and PF are derived parameters that are calculated from these three basic parameters, the same benefits of user-controlled, long-term integration of device behavior are provided. In addition, a control permitting the test engineer to override automatic use of measured power factor in setting test limits is provided in the advanced options setup window.

Class B Harmonic Current Limits

As noted above, Tables 1, 2, and 3 in IEC 1000-3-2 provide limits for permissible harmonic currents respectively for Class A, Class C, and Class D devices. Section 7.2 of IEC 1000-3-2 contains the following language:

"For Class B equipment, the harmonics of the input current shall not exceed the maximum permissible values given in Table 1 multiplied by a factor of 1.5."

In addition, Section 6.2.2 of IEC 1000-3-2 contains the following language regarding transitory harmonic currents:

"a) harmonic currents lasting for not more than 10 s when a piece of equipment is brought into operation or is taken out of operation, manually or automatically, are disregarded.

b) the limits in Tables 1 to 3 are applicable to all other transitory harmonic currents occurring during the testing of equipment or parts of equipment, in accordance with Annex C.

However, for transitory even harmonic currents of order from 2 to 10 and transitory odd harmonic currents of order from 3 to 19, values up to 1.5 times the limits in Tables 1 to 3 are allowed for each harmonic during a maximum of 10% of any observation period of 2.5 min."

One solutions vendor has interpreted the standard to exclude use of the 1.5 multiplier for fluctuating harmonics when testing Class B equipment. Agilent does not find justification for this interpretation in the language, and has therefore elected to provide the multiplier for Class B equipment.

Voltage Distortion Measurement

A discussion about the issues surrounding measurement of voltage distortion during harmonic current tests was provided under “Stated, Implied, and Inferred Requirements.” As previously noted, neither IEC 1000-3-2 nor IEC 1000-4-7 contains any explicit statement that provisions for monitoring voltage distortion must be included in the instrumentation intended for IEC 1000-3-2 testing. If inferences about measurement of source performance are to be made, the most logical inference is to conclude that the use of a mains source with performance guaranteed by design, as is the case with Agilent’s 6840 Series Harmonic/Flicker Test System, is the preferred approach and would eliminate the necessity for source distortion monitoring. This point notwithstanding, Agilent’s implementation **does** include the means for monitoring voltage distortion, but in the interests of cost-effectiveness does not conduct these tests simultaneously with harmonic current measurements.

During the pre-test, voltage distortion is continuously monitored on a harmonic-by-harmonic basis with the highest measured values subsequently compared to the limits given in Annex A of IEC 1000-3-2 for voltage harmonics. An indicator control labeled “Voltage THD” directly beneath the current waveform display shows either “IN SPEC” or “OUT OF SPEC” depending on the outcome of this comparison. Note that there is also a “Voltage THD” meter display near the bottom right corner of the Pre-Test window. This control displays measured Total Harmonic Distortion, but does not reflect the harmonic-by-harmonic comparison that drives the other display.

Agilent’s recommended procedure is to conduct a pre-test of sufficient duration to include all anticipated EUT behavior. This method ensures that voltage distortion performance is continuously verified under actual test conditions, and provides at the same time the integrated measurements used to establish test limits as described above for Class C and Class D devices. Note also that pre-test results may be copied to new filenames. This permits a single pre-test to serve an entire sequence of main tests, a procedure that is both valid and efficient when running a series of tests on a single EUT.

Delay to Start of Test

Section 6.2.2 of IEC 1000-3-2 contains language that states:

“... harmonic currents lasting for not more than 10 s (seconds) when a piece of equipment is brought into operation or is taken out of operation, manually or automatically, are disregarded; ...”

This language is advantageous to most equipment manufacturers because it permits the “inrush” currents that typically occur when a piece of equipment is first powered-up to be excluded from the test. Agilent’s solution includes a control in the advanced setup screen that sets the delay from application of mains power to the EUT to the beginning of measurement. The default value for this delay is 10 seconds, but it may be set anywhere within of range of 0 to 10,000 seconds. Users should be aware that settings greater than 10 seconds make the test non-compliant, but this additional flexibility may be desirable in diagnostic situations.

A similar control is provided in the Pre-Test window to set equivalent delays for pre-tests.

Programmable Current Limits

The “inrush” current phenomenon previously described can create “protection faults” if the peak current levels are high enough to trigger protection circuits contained within the source portions of the 6840 Series Harmonic/Flicker Test System. Some of these circuits provide “latching” operation that must be explicitly “cleared” and which consequently will abort test runs.

All high power solid state sources must include protection circuitry to prevent self-destruction in the presence of uncontrolled load behavior. Proper use of additional controls provided in the Agilent solution can guarantee orderly start-up of EUT’s and avoid protection induced test aborts. Note that this type of load behavior will normally not be seen with compliant EUT devices because inrush current is regulated directly by the Dmax specification in IEC 1000-33, as well as indirectly by IEC 1000-3-2, and thus should not occur at levels capable of generating protection faults.

The “delay to start of test” or measurement delay controls described in the section above may be used in conjunction with current limit controls provided in the advanced setup options screen to control inrush current to levels below those at which triggering of latching protection circuits will occur. Current limiting normally generates detectable errors that invalidate compliance tests since voltage regulation is overridden when current limiting occurs. During the “delay to start of

test” portion of both pre-tests and main tests, current limiting events are ignored. However, once the actual acquisition of measurement data begins, current limit events are again treated as errors that invalidate the test. Since high inrush currents usually occur only during the first few mains cycles following application of mains voltage, a properly set current limit threshold will not be crossed once the “delay to start of test” period has ended. This constructive interaction between the test system and EUT permits the test engineer to limit load currents without invalidating test results.

Both “rms” and “peak” current limits are provided for the Agilent 6841A and 6842A models. The 4800 VA 6843A model provides “rms” current limiting only, in part due to use of a different circuit topology that inherently limits susceptibility to damage from excessive peak currents. The “peak” current limit provides the most useful control for limiting inrush currents since this loop has wide bandwidth. The “rms” limit controls may be used to provide protection to the EUT in the event that it experiences a circuit failure during a test, but care should be taken to pick a setting that provides sufficient margin to avoid unintended limiting during tests. These events will be detected should they occur, but as previously noted, they will also invalidate tests. Default values for all current limit controls are automatically set to the system’s maximum ratings unless overridden by the test engineer.

Implementation of IEC 1000-3-3 and EN 61000-3-3 Standards

Flicker Measurement—UIE Flickermeter

IEC 1000-3-3 states that the reference methodology for measuring flicker requires use of a UIE flickermeter. The UIE (International Union for Electro-Heat) is a quasi-governmental body based in Europe that was involved in early efforts to coordinate activities in individual European countries with the intent of developing internationally accepted definitions for flicker and for instrumentation intended for flicker measurement. The portion of this work directed towards definition of measuring instrumentation eventually was published as IEC 868. This document defines flickermeter implementations and is a normative reference in IEC 1000-3-3.

A flickermeter is fundamentally a specialized AM modulation analyzer designed to operate with mains frequency carrier inputs. The instrument's output is calibrated in terms of human perception of the flicker, or light intensity variations, induced in a 60 W coiled filament incandescent lamp operated at 230 VAC in a 50 Hz mains system. A functional block diagram of a flickermeter as defined in IEC 868 is shown below. The heart of a flickermeter consists of Blocks 2, 3, and 4 which taken together comprise a simulation of the lamp-eye-brain system's response to rms voltage variations that are induced in mains circuits by varying current drains operating against branch circuit impedances. Block 1 consists of scaling circuitry and an automatic gain control function that normalizes input voltages to Blocks 2, 3, and 4, while Block 5 consists of a statistical classifier the output of

which is a probability density function used to compute short-term flicker severity, or Pst. The overall instrument is calibrated so that an output of 1.00 from Block 4 corresponds to the "reference human flicker perceptibility threshold" while a Pst value of 1.00 derived from the outputs of Block 5 corresponds to the "the conventional threshold of irritability" per IEC 1000-3-3.

RMS Measurements

In 50 Hz mains systems, the output of Block 1 of the flickermeter is a 100 sample/second data stream consisting of rms voltage measurements made continuously (without gaps) on a half-cycle by half-cycle basis. In a 60 Hz mains system, the corresponding data rate is 120 samples/second; however, it should be noted that at present there is no flicker standard for 60 Hz systems. Note that Agilent's implementation does include functionality for 60 Hz systems. When standards for 60 Hz systems are written, it may require modification to the transfer functions in Blocks 2, 3, and 4.

The rms voltage data stream within Block 1 may be taken before the automatic gain control function and processed to extract the "relative voltage change" characteristic that is the basis for evaluating EUT performance against limits for Dmax, Dc, and Dt per IEC 1000-3-3.

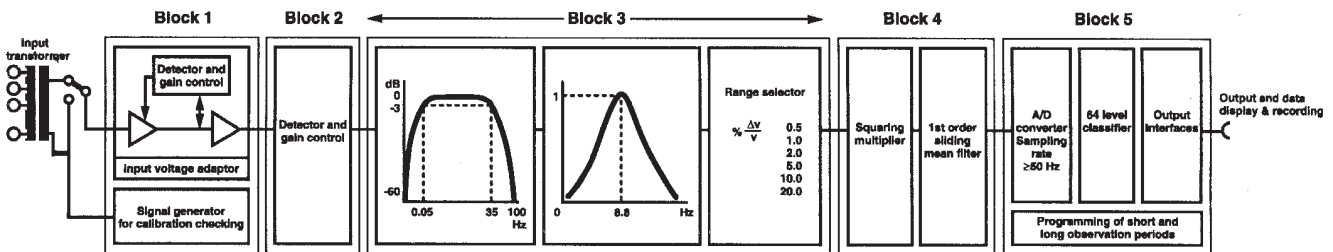

Figure 25. Flickermeter block diagram

Pst Classifier

Various implementations for the classifier within Block 5 are described in IEC documents. IEC 868 Amendment 1 describes a logarithmic classifier that eliminates the need for the ranging functionality shown at the output of Block 3, and which also mitigates the need for “zero extrapolation” when relatively low flicker levels are measured. Agilent’s implementation uses this technique with a 1024 bin classifier that covers 6 decades of flicker perceptibility ranging from 0.01 to 10,000 perceptibility units. The classifier “bins” individual flicker measurements by level which results in a 1024 point array. This array contains the accumulated total counts of flicker levels corresponding to each bin’s “weight” in perceptibility units that have occurred during the Pst integration period. IEC 868 states that this “observation” period may be 1, 5, 10, or 15 minutes. IEC 1000-3-3 specifies that the integration period will be 10 minutes.

Agilent’s HFTS software application, included with the 6840 Series Harmonic/Flicker Test System, further processes the 1024 point array to produce a cumulative probability function that gives the flicker levels (or percentiles) associated with probabilities of occurrence corresponding to 0.1, 1.0, 3, 10, and 50% of the time during the observation period. These values are then used to calculate Pst by means of the following equations specified by IEC 868 Amendment 1:

$$P_{st} = \sqrt{0.0314P_{0.01s} + 0.0525P_{1s} + 0.0657P_{3s} + 0.28P_{10s} + 0.08P_{50s}}$$

The “s” subscript indicates use of “smoothed” values which are calculated from the cumulative probability function as follows:

$$P_{50s} = (P_{30} + P_{50} + P_{80}) / 3$$

$$P_{10s} = (P_6 + P_8 + P_{10} + P_{13} + P_{17}) / 5$$

$$P_{3s} = (P_{2.2} + P_3 + P_4) / 3$$

$$P_{1s} = (P_{0.7} + P_1 + P_{1.5}) / 3$$

IEC 1000-3-3 specifies that a flicker test shall consist of 12 Pst integration periods. The Pst values from each integration period are used to calculate long-term flicker severity (Plt) according to an additional equation specified by IEC 868 Amendment 1:

$$P_{lt} = \sqrt[3]{\left(\sum_{i=1}^N P_{sti}^3\right) / N} \quad \text{Note: } N=12 \text{ for a standard test}$$

Agilent 6840 Series Flickermeter

The fully compliant flickermeter embedded in the 6840 Series Harmonic/Flicker Test System makes IEC 1000-3-3 testing for flicker a very straightforward process. Agilent’s implementation provides a Pre-Test window similar to the one used for IEC 1000-3-2 tests. A pre-test must be run prior to running main tests, but the information gathered during the pre-test is presented mainly as a confidence check for proper EUT operation. None of the acquired data is used to set test limits nor is there any possibility that the specified source distortion limit of 3% THD will be exceeded while testing compliant EUT’s. As with IEC 1000-3-2 testing however, there are several technical and interpretive issues surrounding IEC 1000-3-3 testing and IEC 868 that merit discussion.

Use of a Simulated Impedance

IEC 1000-3-3 requires use of a “reference impedance” that is placed between an ideal source and the EUT. For single phase 230 V, 50 Hz systems, line and neutral impedances may be lumped and are specified to have a value in total of $0.4 + j 0.25$ ohms. This value represents an internationally agreed upon “typical” branch circuit impedance across which flicker voltages are developed in response to EUT current drains. Voltage is sensed at the mains input terminals of the EUT and flicker voltages are thus properly observed.

Section 6.4 of IEC 1000-3-3 states:

“For equipment under test the reference impedance, Z_{ref} , according to IEC 725, is a conventional impedance used in the calculation and measurement of the relative voltage change “d” and the Pst and Plt values.”

Agilent’s implementation uses multiple feedback loops to provide a loop implemented source impedance having programmable resistive and inductive components. The nominal range of values for the resistive component is 0 to 1.0 ohms and for the inductive component is 20 to 1000 μ H. The $j 0.25$ inductive component required by IEC 1000-3-3 corresponds to 796 μ H. Remote sensing at the EUT input terminals causes the total mains circuit impedance to equal the programmed values.

Typical IEC test solutions make use of discrete passive components to implement the reference impedance. There are no statements in the standard that specify implementation details for the component parts of the reference impedance. It is Agilent’s belief that the word “conventional” cited above merely refers to the existence of a mutual agreement among the parties involved in the discussions that are extensively documented in IEC

725. A loop implementation has the decided advantages of being dissipationless and programmable, with the latter capability opening the possibility of efficient accommodation of differing national standards for reference impedances. Agilent believes these advantages will lead to widespread adoption of loop-based implementations as use of high performance sources becomes more common.

Section 6.2 of IEC 1000-3-3, which states measurement accuracy requirements, contains a requirement for an “overall accuracy” of $\pm 8\%$. Agilent’s design philosophy was to allocate 3% to the reference impedance while reserving the remainder of the permissible error, in accordance with stated requirements, for other sources. This approach is consistent with general allowances for total measurement error given in IEC 868, and provides a conservative overall error budget especially considering that errors of $<1\%$ for both the resistive and inductive components measured independently were documented during design evaluations of Agilent’s loop implemented impedance. Worst case performance of $\pm 3\%$ performance is guaranteed.

Squarewave Response Tests per IEC 868

IEC 868 includes tables containing provisions for “overall analog response” for sinusoidal and rectangular (i.e., squarewave) voltage fluctuations (i.e., modulations). Tables 1 and 2, respectively, prescribe modulation levels for modulating frequencies ranging from 0.5 Hz to 25 Hz that correspond to outputs of 1.00 from Block 4. The actual modulation levels producing outputs of 1.00 are required to be within $\pm 5\%$ of the values shown in the tables.

An extensive discussion of the performance of Agilent’s flickermeter implementation is given in Appendix A. However, there is one issue related to performance with squarewave modulation that is more fully discussed here.

Complying with values given for sinusoidal modulations is straightforward given a proper implementation of Blocks 2, 3, and 4. Requirements for rectangular modulations are another matter. The test requirements given in Table 2 are impossible to meet unless the modulating signal is lowpass filtered, prior to modulation, by a filter having the equivalent of a single pole RC characteristic with the corner frequency set to approximately 100 Hz. Filtering is necessary because the higher order harmonics present in squarewave signals produce multiple responses within the passband of the weighting filter in Block 3, and are not properly accounted for in Table 2’s prescriptions when modulating frequencies are above 15 Hz.

The fifth harmonic of a 22 Hz squarewave modulating signal is particularly troublesome in this respect. Considering for a moment this 110 Hz frequency component alone, modulation of a 50 Hz carrier produces upper and lower sidebands at $F_c \pm F_{mod}$ (i.e., at 60 Hz and 160 Hz). The component at 60 Hz is the lower sideband “folded back” around DC so that it appears reversed in phase at 60 Hz. This 60 Hz component, when detected by the squaring demodulator, appears at 10 Hz, which is nearly at the response peak of the weighting filter contained within Block 3. Despite the fact that this detected component is considerably lower in magnitude than the detected 22 Hz fundamental component, the relative response of the weighting filter at the two frequencies produces sufficient output from the fifth harmonic to exceed the limits specified in Table 2.

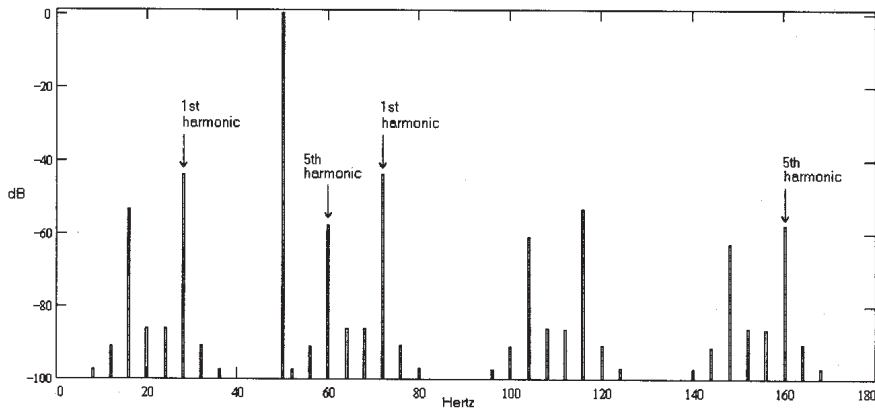

Figure 26. Carrier and modulating components (50 Hz carrier with 1%, 22 Hz squarewave modulation)

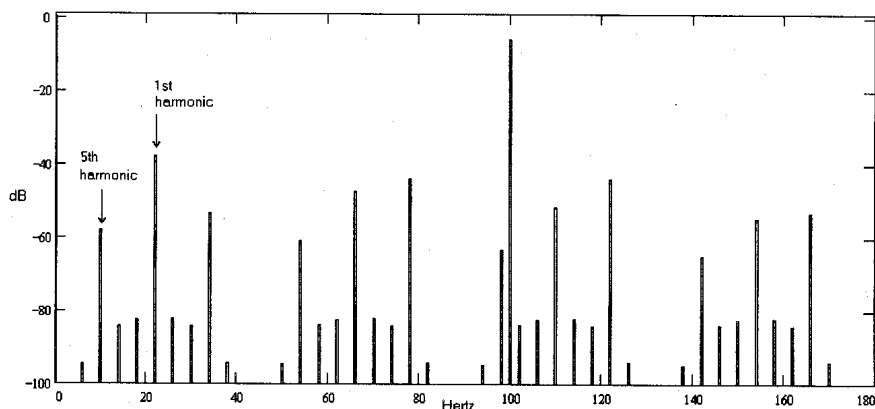

Figure 27. Detected modulating components from Figure 26, prior to weighting filter in Block 3

It is always risky to speculate on why an oversight of this type found its way into a document such as IEC 868, particularly since squarewave response is correctly tabulated at lower frequencies. Despite this, one guess may be that at the time this work was done, the relatively limited bandwidths available in mains sources may have suppressed any obvious manifestations of higher harmonic responses for modulating frequencies above 15 Hz. A recent IEC publication, 77A(SEC)113, which discusses proposed revisions to IEC 868, includes modifications to Table 2 which appear to account for the effects described above.

Unclear Definitions for Dmax, Dc, and Dt

In Agilent's view, the most difficult interpretive issue in IEC 1000-3-3 involves Definitions 3.1 through 3.4, Figures 2 and 3, and requirements for evaluating Dmax, Dc, and Dt. An edited version of Figure 3, which shows the generally accepted interpretations for these parameters, is shown below as is the complete text of Definitions 3.1 through 3.4.

“3.1 R.M.S. voltage shape, $U(t)$: The time function of the r.m.s. voltage evaluated stepwise over successive half-periods of the fundamental voltage (see Figure 2).

3.2 voltage change characteristic, $\Delta(t)$: The time function of the change in the r.m.s. voltage between periods when the voltage is in a steady-state condition for at least 1 s (second) (see 4.2.3 and Figure 2).

3.3 maximum voltage change, ΔU_{max} : The difference between maximum and minimum r.m.s. values of the voltage change characteristic (see Figure 2).

3.4 steady-state voltage change, ΔU_c : The difference between two adjacent steady-state voltages separated by at least one voltage change characteristic (see Figure 2).

NOTE - Definitions 3.2 to 3.4 relate to absolute phase-to-neutral voltages. The ratios of these magnitudes to the phase-to-neutral value of the nominal voltage (U_n) of the reference network in Figure 1 are called:

- *relative voltage change characteristic: $d(t)$ (definition 3.2):*
- *maximum relative voltage change: d_{max} (definition 3.3):*
- *relative steady-state voltage change: d_c (definition 3.4):*

These definitions are explained by the example in Figure 3.”

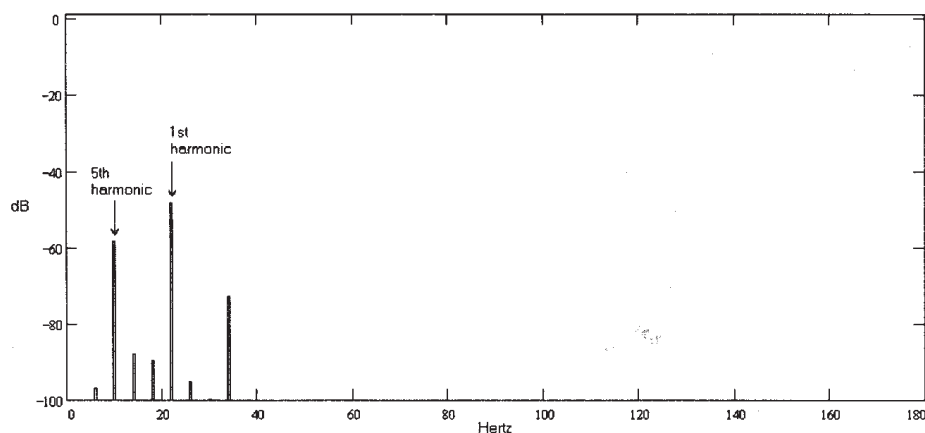

Figure 28. Detected modulating components after weighting filter in Block 3

The greatest interpretive difficulty arises from the lack of an adequate definition of “steady-state.” It seems clear, given the text reproduced above, that successive half-cycle rms voltage measurements must meet some criteria for at least one second to qualify as steady-state. What is not given anywhere within IEC 1000-3-3 is a definition of the amplitude characteristic of steady-state. Since it is very unlikely that successive measurements will produce exactly identical readings even with perfectly constant load behavior, it is left up to the reader to conclude what might be a reasonable band within which one second’s worth of successive readings must fall in order to qualify as steady-state.

Agilent’s inferred definition is $\pm 0.15\%$ of the nominal line voltage (U_n). While the complete absence of a definition makes one interpretation as good as any other, there are solid reasons for making the choice just described. The error allocation for measuring instrumentation is 5% while the stated limit for Dc is 3%. Taking both specifications into account (i.e., 5% of 3%) suggests that a tolerance of $\pm 0.15\%$ for a steady-state condition is a reasonable guess at the standard’s intent. This band is also consistent with the output noise performance of Agilent’s sources and readily permits detection of steady-state EUT behavior.

Since setting this tolerance band is critical to detection of voltage change events, and to avoid imposing a specific interpretation on others who may see it differently, Agilent’s HFTS software application uses an entry in the `hfts.ini` file that contains initialization information for the application to set the tolerance band. The entry is factory set to 0.003 (i.e., 0.3% for the total tolerance band), but may be easily edited by those subscribing to a different interpretation.

There are other interpretive issues with Dmax, Dc, and Dt. Agilent takes the language in the note included in Definition 3.4, particularly the inclusion of the word “relative” and the reference to Figure 3 of IEC 1000-3-3, to mean two things:

1. The term “relative” means that voltage changes are evaluated relative to the value of the steady-state voltage immediately preceding the voltage change characteristic under evaluation.
2. Relative voltage changes are expressed as a percentage of the nominal mains voltage U_n .

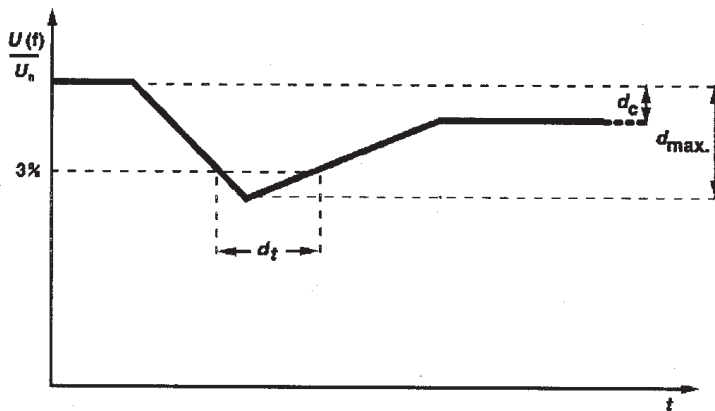

Figure 29. Edited version of Figure 3

Establishing a tolerance band to define steady-state together with the interpretations just described permits a reasonably straightforward evaluation for Dc.

The voltage change characteristic shown in Figure 3 of IEC 1000-3-3 lends itself to a simple evaluation for Dmax as well. Consider, however, a situation where a sudden increase in EUT current causes a dip in rms voltage (in excess of 2% for example) followed by an extended period of time during which steady-state conditions are **not** re-established, but during which the rms voltage approaches the previous steady-state value. Assume now that a sudden decrease in EUT current drain causes a surge in rms voltage that just exceeds a 2% **increase** relative to the previous steady-state voltage. This is followed by a decrease in rms voltage so that eventually a steady-state condition is re-established at a level not too different from the previous steady-state condition.

A literal interpretation of Definition 3.3 would seem to require that Dmax be reported at a value greater than 4% which would constitute a failure. Using what is known about how human perception of flicker works, this would seem to be an excessively conservative assessment, particularly since the period of time between the minimum and

maximum values is unspecified and could range from milliseconds to minutes. Pending clarification on this issue, Agilent has adopted a definition more in keeping with Figure 3 of IEC 1000-3-3 that records the greatest excursion in absolute terms from the previous steady-state value as Dmax.

Because of the potentially unlimited storage requirements for on-line analysis of Dmax, Dc, and Dt events, Agilent has made two additional interpretive inferences that are directed towards meeting the intent of the standard while still permitting a practical implementation:

1. Steady-state conditions may never be achieved during a test, in which case values for Dmax, Dc, and Dt will not be reported.
2. In the situation where steady-state conditions are established, Agilent's solution reports the maximum Dmax, Dc, and Dt events occurring within each Pst integration period. These values are then compared to the specifications stated in IEC 1000-3-3 to determine pass/fail.

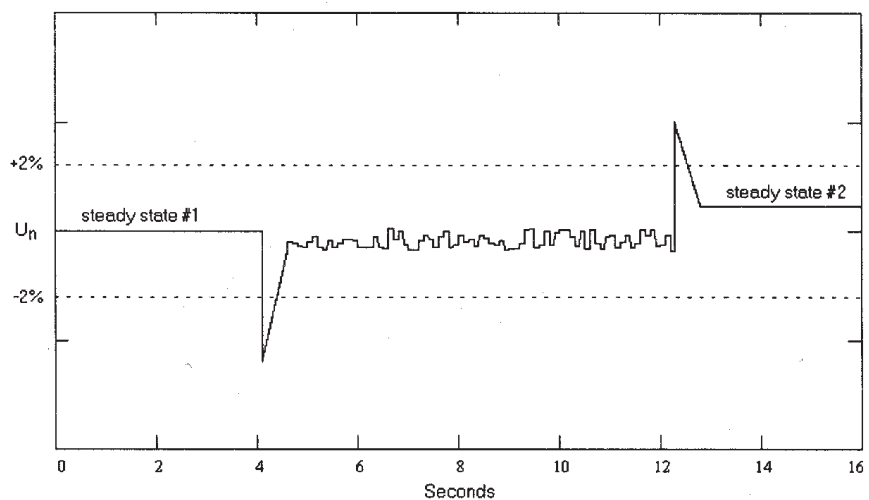

Figure 30. Dmax evaluation example

Delay to Start of Test

Unlike IEC 1000-3-2, IEC 1000-3-3 contains no language excluding inrush current events in the first 10 seconds following power-up. Events of this type will have little or no impact on flicker test results in any case, but potentially will have major impact on Dmax, Dt, and Dc test results. For these requirements, the language included in Section 5 of IEC 1000-3-3 is explicit:

“If voltage changes are caused by manual switching or occur less frequently than once per hour, the Pst and Plt requirements shall not be applicable. The three requirements related to voltage changes shall be applicable with the previously mentioned voltage values, multiplied by a factor of 1.33.”

Since this language implies that the EUT, if it is subject to manual switching, will in fact be operated manually during the test, the measurement delay controls have no consequential impact on test results. For this reason, Agilent’s solution makes these controls available in the interest of providing consistent functionality across the application, but with the expectation that the test engineer will make use of them in an informed manner.

Similarly, voltage change test results (i.e., Dmax, Dc, and Dt) are reported as measured and compared against the normal limits. It is expected that the test engineer will determine if the 1.33 multiplier should properly be applied, and if so, that the multiplier will be manually applied as part of the analysis of test results as reported in the “long form” report. Alternatively, the limit override control provided for rms parameters in the “Advanced Options” setup screen may be set to 133% to provide automatic scaling of the rms test limits.

Appendix A

Flickermeter Verification Tests

To the best of Agilent Technologies' knowledge, there is no official certification for UIE flickermeter implementations. The IEC commission does not endorse products offered by instrumentation manufacturers, nor does it provide services or recommend test laboratories to verify compliance with its published standards, either for the products regulated by the standards or for instrumentation designed to test these products.

The design team for the 6840A Series Harmonic/Flicker Test System conducted their own assessment of measurement accuracy for Agilent's flickermeter implementation. The results are attached and a discussion of the test methodologies follows. This discussion includes a description of alternate methods, the relative merits of these methods, and the reasons for selecting the particular method used.

A UIE Flickermeter is a specialized AM receiver that is designed to detect amplitude modulations of the ac mains and present the detected signals in terms of human perceptibility of incandescent lamp flicker. The attached tables show the results of three sets of tests, defined by IEC 868 and IEC 868 Amendment 1, that are intended to test compliance of flickermeter implementations with measurement accuracy requirements described in the standards. One set of the tests checks accuracy in terms of peak flicker response with sinewave modulations (Table A-1), while the other two check peak flicker response (Table A-2) and Pst measurement accuracy with squarewave modulations (Table A-3).

A common feature of all three tests is a requirement for relatively small modulation depths and for considerable precision in controlling modulation depth. This may be seen by examining the columns labeled "Modulation dV/V (%); nominal" in each table. The dV/V parameter describes the difference between the maximum rms value of the modulated carrier (nominally 230 Vac @ 50 Hz) and the minimum rms value of the carrier and is expressed as a percentage of the rms value of the ac mains frequency carrier. In the more conventional measure of modulation as a percentage of peak-to-peak carrier amplitude, the equivalent value is one half the value shown in the tables. Therefore, the requirement for precision is actually more severe than it appears to be at first glance. In addition, IEC 868 specifies that the modulation level producing a peak flicker response of 1.00 must be within $\pm 5\%$ of the nominal value. These delta values are shown in the tables for peak flicker response in the columns labeled "Modulation dV/V (%); low and high." Examination of the magnitude of the differences from the nominal value makes it clear that performance verification requires control over modulation depth to resolutions of approximately 1 ppm and accuracies of 10 ppm.

The required test signals might be obtained by precisely modulating a load, by precisely modulating the generated output without a load, or by measuring the effect produced by an uncalibrated load or modulation using a 230 Vac 50 Hz input modulation meter having measurement resolutions to 0.0001% and corresponding accuracy. Off-the-shelf equipment with these capabilities is simply not available. Another technique described in some of the literature is to select a very low frequency squarewave modulation and use a precision DVM to measure the two rms levels. This technique works, but becomes an act of faith when the assumption is made that once calibrated in this manner, the test source may be switched to sinewave modulation and/or to higher modulation frequencies without loss of calibration.

The problems documented above led Agilent's design team to adopt a different approach. The block diagram in Figure A-1 shows the technique used.

Agilent's 6840 Series Harmonic/Flicker Test System uses a firmware implemented DDS (direct digital synthesis) technique to generate the output waveform. DDS generation produces programmable output frequencies with fine frequency resolution and crystal accuracies. The 6840 Series products also include a fully digital implementation of the UIE

Flickermeter. This implementation includes digitization of the mains voltage input to the Equipment Under Test (EUT) with a 16-bit A/D converter operating at approximately 40K samples/second. All digital signal processor operations are performed on 32-bit floating point values and the A/D converter readings are immediately converted to floating point representations following digitization. Since these numbers have approximately 7 decimal digits of resolution, despite having only 16 bits of quantization and dynamic range, it is possible to implement a highly precise digital AM modulator that acts directly on the stream of digitized samples of the voltage input to the EUT. Addition of a second DDS generator as the modulation frequency source permits generation of extremely accurate and repeatable test signals thus providing a means for characterizing all system errors except those introduced by the A/D converter and the differential amplifier connecting it to the EUT. These additional errors are discussed separately later. Note that a lowpass filter is shown in the modulation signal path. This attenuates the higher frequency components of squarewave modulating waveforms to prevent problems with responses to these signals that are not accounted for in Table 2 from IEC 868.

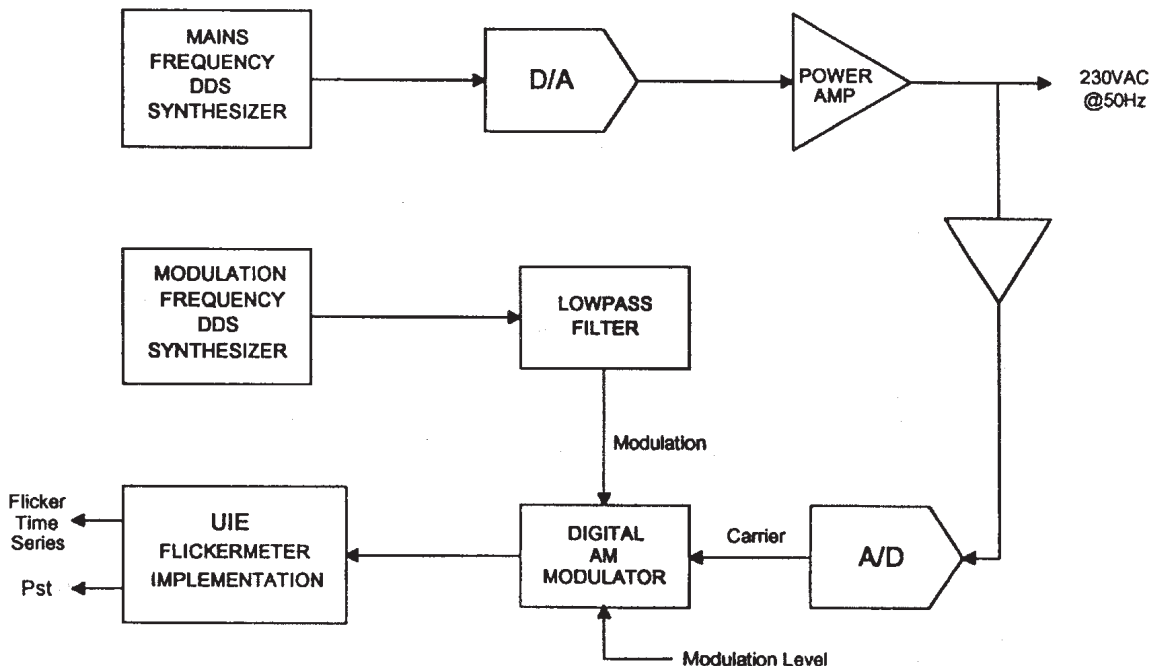

Figure A-1. Flickermeter block diagram

One outstanding quality of the Agilent 6840 Series Harmonic/Flicker Test System, both from the standpoint of making actual flicker measurements and from the standpoint of verifying performance, is that given identical inputs, its fully digital architecture provides identical results every time.

All tests were conducted with the output programmed to 230 Vac and 50 Hz with no load. This sets the A/D outputs to the level corresponding to the midrange value encountered during an actual test. Since the filters in a UIE flickermeter have very long time constants, the test procedure described in IEC 868 was modified from a procedure of sweeping the modulation level to produce a reading of 1.00 to one of testing at the specification limits of 95% and 105% of nominal modulation and then using a simple algebraic manipulation to calculate the modulation level that would produce a Pst reading of 1.00. The extremely wide dynamic range and fine resolution provided by the 32-bit floating point implementation makes this approach completely appropriate for demonstrating compliance with IEC 868 requirements.

The results for peak flicker response with sine-wave and squarewave modulations at the modulating frequencies and depths described in IEC 868 are shown in the columns labeled “dV/V (%) for reading of 1.00” and “Deviation from nominal, % of nominal.” The second column documents the errors introduced by the flickermeter implementation in accordance with the test limits as described in the standard and must show values between -5% and +5% for the implementation to meet specification. These errors are predominantly caused by the bandpass filter at the heart of the flickermeter and arise largely because the transfer function specified in IEC 868 and the specified test modulation levels are all empirically derived, but unfortunately not from the same data sets. This brings up the

interesting question of whether it is possible to “improve” the transfer function. Our conclusion is that the answer is “yes,” but the design team decided that it was better to implement the transfer function exactly as specified and live with the errors rather than attempt to second guess the standard’s authors. In any case, the 6840 Series Harmonic/Flicker Test System meets specified test accuracy across the board.

Quantization Errors

The errors introduced by the A/D converter and the differential amplifier must also be taken into account. The differential amplifier acts as a voltage divider and is implemented with precision components that cause it to introduce total errors of less than 0.1% over the entire operating range of the instrument. These errors therefore make a negligible contribution to the total error budget. The specified voltage measurement accuracy for the 6840 Series Harmonic/Flicker Test System is better than 0.08% at 230 Vac and thus this error source also makes a negligible contribution.

Another more subtle issue with the A/D conversion process exists, however. Quantization error, or the limited ability of the A/D converter to resolve different input magnitudes, contributes the major error associated with the A/D conversion process. A number of different techniques may be used to analyze this effect and depending upon the particular technique selected, and upon the detail of the analysis, various factors including frequency domain noise floor, quantization error, averaging effects, linearity errors, modulation waveshape, etc. may be taken into account. A detailed accounting of these issues is beyond the scope of this discussion, but a simple examination of quantization error (or resolving power) is illustrative.

The 16-bit A/D converter used in the 6840 Series Harmonic/Flicker Test System, when taking into account the 500 V peak range of the voltage measurement circuit, provides a bit weight of approximately 15.3 mV. Assuming monotonic and linear behavior, the maximum deviation between an actual input and a quantized value is 1/2 LSB or approximately 7.6 mV. Dividing this value by the peak voltage change at 230 Vac that is equivalent to the specified modulation level and multiplying by 100 yields the percentage of nominal modulation equivalent to the resolving power of the A/D converter. This value is shown for each test case in the tables for peak flicker response in the column labeled "A/D resolution @ 230 V." These values are then summed with the errors attributable to the flicker-meter implementation to yield a "worst case" error. Once again, errors for all specified test conditions are **within** the specified limits. Note that factors such as averaging effects have not been considered, but generally these factors will act to improve resolution rather than degrading it, and resolution is the issue here rather than absolute accuracy. It is assumed that the benefits of averaging together with the fact that A/D conversions extend over a wide range of codes will overcome errors introduced by nonlinearities in the conversion process.

The third table is for Pst measurement verification. This test is described in IEC 868 Amendment 1. The Pst test is specified somewhat differently in that an exact modulation is prescribed and the implementation must simply produce an output that is between 0.95 and 1.05 for each prescribed modulation. The results of tests conducted using the methodologies described above are shown in the table for Pst measurement accuracy. The 6840 Series Harmonic/Flicker Test System again meets requirements across the board. Because Pst is derived from a statistical processing of 60,000 individual measurements, the A/D resolution issues described above are largely removed by the averaging effects implicit in the statistical calculation.

The final contributor to total measurement error is the reference impedance, $0.4 + j 0.25$ ohms for single phase 50 Hz systems. Agilent's programmable impedance is specified at $\pm 1.0\%$ error at room temperature and $\pm 3\%$ error over the full operating range of the instrument. This error, when algebraically summed with the errors described above, maintains the instrument within the $\pm 8\%$ total error budget permitted by the IEC standards.

Table A-1. Squarewave Modulation Test Results

MODULATION FREQ	MODULATION dV/V (%)		PEAK RESPONSE (FLICKER PERCEPTIBILITY)		dV/V(%) for READING OF 1.00	Deviation from nominal (% Of Nominal Modulation)	A/D Resolution @ 230V (% of Nominal Modulation)	Worst Case Error (% of Nominal Modulation)
	LOW	NOMINAL	LOW	HIGH				
0.5 Hz	2.223	2.340	0.942	1.151	2.290	-2.12	0.10	-2.22
1.0 Hz	1.360	1.432	0.979	1.195	1.375	-3.75	0.16	-4.15
1.5 Hz	1.026	1.080	0.955	1.165	1.050	-2.79	0.22	-3.00
2.0 Hz	0.838	0.882	0.938	1.146	0.865	-1.91	0.27	-2.18
2.5 Hz	0.716	0.754	0.950	1.159	0.735	-2.53	0.31	-2.84
3.0 Hz	0.621	0.654	0.956	1.170	0.635	-2.84	0.36	-3.20
3.5 Hz	0.540	0.568	0.946	1.156	0.555	-2.33	0.41	-2.74
4.0 Hz	0.475	0.500	0.943	1.151	0.489	-2.17	0.47	-2.64
4.5 Hz	0.424	0.446	0.949	1.160	0.435	-2.48	0.53	-3.01
5.0 Hz	0.378	0.398	0.942	1.146	0.390	-2.12	0.59	-2.71
5.5 Hz	0.342	0.360	0.946	1.153	0.352	-2.33	0.65	-2.98
6.0 Hz	0.312	0.328	0.946	1.155	0.320	-2.33	0.72	-3.04
6.5 Hz	0.285	0.300	0.933	1.136	0.295	-1.65	0.78	-2.43
7.0 Hz	0.266	0.280	0.938	1.136	0.275	-1.91	0.84	-2.75
7.5 Hz	0.253	0.266	0.934	1.142	0.261	-1.70	0.88	-2.58
8.0 Hz	0.238	0.250	0.926	1.131	0.247	-1.28	0.94	-2.22
8.5 Hz	0.241	0.254	0.922	1.127	0.251	-1.06	0.92	-1.98
9.0 Hz	0.247	0.260	0.920	1.113	0.258	-0.96	0.90	-1.86
10.0 Hz	0.257	0.270	0.915	1.120	0.268	-0.69	0.87	-1.55
10.5 Hz	0.268	0.282	0.910	1.111	0.281	-0.41	0.83	-1.24
11.0 Hz	0.281	0.296	0.902	1.104	0.296	0.03	0.79	0.82
11.5 Hz	0.296	0.312	0.902	1.099	0.312	0.03	0.75	0.78
12.0 Hz	0.331	0.348	0.889	1.089	0.351	0.76	0.67	1.43
13.0 Hz	0.369	0.388	0.881	1.076	0.393	1.21	0.60	1.82
14.0 Hz	0.410	0.432	0.870	1.069	0.440	1.85	0.54	2.39
15.0 Hz	0.456	0.480	0.871	1.066	0.489	1.79	0.49	2.28
16.0 Hz	0.504	0.530	0.866	1.058	0.541	2.09	0.44	2.53
17.0 Hz	0.555	0.584	0.866	1.057	0.596	2.09	0.40	2.49
18.0 Hz	0.608	0.640	0.861	1.052	0.655	2.38	0.37	2.75
19.0 Hz	0.665	0.700	0.861	1.053	0.717	2.38	0.34	2.72
20.0 Hz	0.722	0.760	0.854	1.043	0.781	2.90	0.31	3.11
21.0 Hz	0.783	0.824	0.850	1.037	0.849	3.04	0.28	3.33
22.0 Hz	0.846	0.890	0.843	1.031	0.921	3.47	0.26	3.73
23.0 Hz	0.914	0.962	0.841	1.027	0.997	3.59	0.24	3.84
24.0 Hz	0.990	1.042	0.846	1.033	1.076	3.29	0.23	3.51
25.0 Hz								

Table A-2. Sinewave Modulation Test Results

MODULATION FREQ	MODULATION dV/V (%)		PEAK RESPONSE (FLICKER PERCEPTIBILITY)		dV/V (%) for READING OF 1.00	Deviation from nominal (% Of Nominal Modulation)	A/D Resolution @ 230V (% of Nominal Modulation)	Worst Case Error (% of Nominal Modulation)
	LOW	NOMINAL	LOW	HIGH				
0.5 Hz	0.488	0.514	0.540	1.148	0.501	-2.53	0.46	-2.99
1.0 Hz	0.447	0.471	0.495	1.141	0.463	-1.60	0.50	-2.09
1.5 Hz	0.410	0.432	0.454	1.154	0.422	-2.43	0.54	-2.97
2.0 Hz	0.381	0.401	0.421	1.133	0.391	-2.38	0.58	-2.96
2.5 Hz	0.355	0.374	0.393	1.162	0.363	-2.84	0.63	-3.47
3.0 Hz	0.337	0.355	0.373	1.162	0.345	-2.74	0.66	-3.40
3.5 Hz	0.328	0.345	0.362	1.159	0.336	-2.53	0.68	-3.21
4.0 Hz	0.316	0.333	0.350	1.148	0.326	-2.22	0.70	-2.93
4.5 Hz	0.300	0.316	0.332	1.167	0.307	-2.84	0.74	-3.58
5.0 Hz	0.278	0.293	0.308	1.163	0.286	-2.53	0.80	-3.33
5.5 Hz	0.256	0.269	0.282	1.152	0.263	-2.07	0.87	-2.94
6.0 Hz	0.237	0.249	0.261	1.147	0.243	-2.22	0.94	-3.16
6.5 Hz	0.219	0.231	0.243	1.149	0.227	-1.81	1.02	-2.93
7.0 Hz	0.206	0.217	0.228	1.141	0.213	-2.01	1.08	-3.10
7.5 Hz	0.197	0.207	0.217	1.156	0.202	-2.22	1.13	-3.36
8.0 Hz	0.189	0.199	0.209	1.181	0.192	-3.44	1.18	-4.62
8.5 Hz	0.190	0.200	0.210	1.153	0.196	-2.22	1.17	-3.40
9.0 Hz	0.195	0.205	0.215	1.171	0.203	-0.85	1.14	-1.99
9.5 Hz	0.202	0.213	0.224	1.144	0.209	-1.75	1.10	-2.85
10.0 Hz	0.212	0.223	0.234	1.146	0.219	-1.65	1.06	-2.70
10.5 Hz	0.222	0.234	0.246	1.134	0.230	-1.60	1.00	-2.60
11.0 Hz	0.234	0.246	0.258	1.122	0.243	-1.38	0.95	-2.34
12.0 Hz	0.234	0.246	0.258	1.137	0.243	-1.38	0.85	-2.24
13.0 Hz	0.261	0.275	0.289	1.137	0.271	-1.06	0.78	-1.82
14.0 Hz	0.283	0.308	0.323	1.117	0.305	-0.47	0.62	-1.08
15.0 Hz	0.327	0.344	0.361	1.124	0.341	-1.65	0.56	-2.21
16.0 Hz	0.361	0.380	0.399	1.106	0.378	-1.44	0.51	-1.95
17.0 Hz	0.400	0.421	0.442	1.131	0.414	-0.25	0.46	-0.71
18.0 Hz	0.438	0.461	0.484	1.129	0.454	0.08	0.42	1.41
19.0 Hz	0.481	0.506	0.531	1.109	0.505	0.08	0.39	0.47
20.0 Hz	0.524	0.552	0.580	1.079	0.557	-2.27	0.36	-2.63
21.0 Hz	0.573	0.603	0.633	1.108	0.604	-1.01	0.33	-1.34
22.0 Hz	0.624	0.657	0.690	1.146	0.642	0.14	0.31	0.44
23.0 Hz	0.677	0.713	0.749	1.121	0.706			
24.0 Hz	0.729	0.767	0.805	1.098	0.768			

Table A-3. Pst Accuracy with Squarewave Modulation

Modulation Frequency (Voltage changes/min.)	Hertz	Modulation (dV/V in %)	Pst Reading (Flicker Perceptibility)	Pst Reading (% of nominal)
1	0.00833	2.724	1.044	4.4
2	0.01667	2.211	1.025	2.5
7	0.05833	1.459	1.022	2.2
39	0.32500	0.906	1.027	2.7
110	0.91667	0.725	1.018	1.8
1620	13.50000	0.402	0.990	-1.0

Worst Case Error (% of nominal modulation)

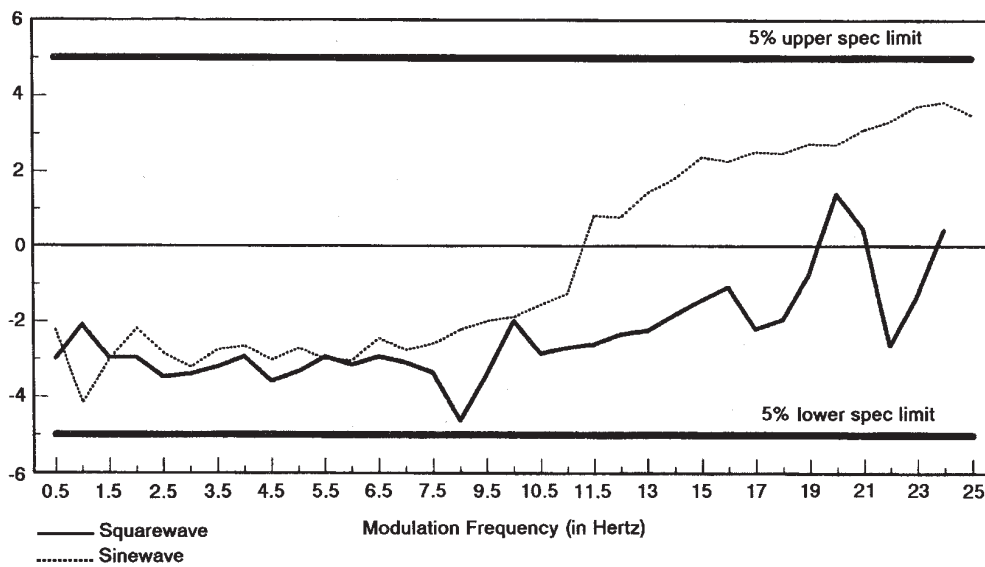

Figure A-2. Agilent 6840 Series squarewave and sinewave modulation test summary

Pst Reading (% of nominal)

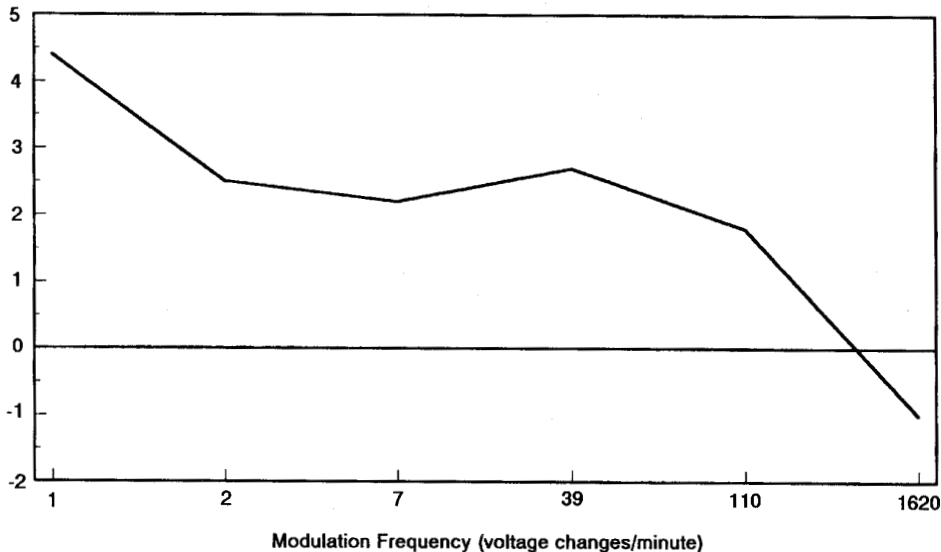

Figure A-3. Agilent 6840 Series Pst accuracy with squarewave modulation summary

References

Ford, John, *The VOLTECH Handbook of Testing to JEC555*, 1993

McCarthy, Darren, "Immunity and Low Frequency Emissions Standards," IEEE SCV EMC Symposium, March 1994

Satoh, Akira, *Japan Powerline Harmonics Requirements Overview*, 1995

IEC 555-1 (1982), "Part 1: Definitions"

IEC 555-2 (1982), "Part 2: Harmonics"

Amendment No. 1 (1984)

Amendment No. 2 (1988)

Amendment No. 3 (1991)

IEC 77A (SEC) 113 (1994), "Part 4: Testing and measuring techniques Section 15: Flickermeter—Functional and design specifications."

IEC 725 (1981), "Considerations on reference impedances for use in determining the disturbance characteristics of household appliances and similar electrical equipment."

IEC 816 (1984), "Guide on methods of measurement of short duration transients on low voltage power and signal lines."

IEC 827 (1985), "Guide to voltage fluctuation limits for household appliances (relating to IEC Publication 555-3)."

IEC 868 (1986), "Flickermeter, Functional and design specifications."

IEC 868 Amendment 1 (1990), "Flickermeter, Functional and design specifications."

IEC 868-0 (1991), "Part 0: Evaluation of flicker severity."

IEC 1000-1-1 (1992), "Part 1: General—Section 1: Application and interpretation of fundamental definitions and terms."

IEC 1000-3-2 (1995), "Part 3: Limits—Section 2: Limits for harmonic current emissions (equipment input current ≤ 16 A per phase)."

IEC 1000-3-3 (1994), "Part 3: Limits—Section 3: Limitation of voltage fluctuations and flicker in low-voltage supply systems for equipment with rated current ≤ 16 A."

IEC 1000-4-1 (1992), "Part 4: Testing and measurement techniques. Section 1: Overview of immunity tests. Basic EMC Publication."

IEC 1000-4-7 (1991), "Part 4: Testing and measurement techniques. Section 7: General guide on harmonics and inter-harmonics measurements and instrumentation for power supply systems and equipment connected thereto."

IEC SC 77A/WGOI/TF02 (1995), "Draft, Minutes of the 3rd meeting held in Paris on January 26, 1995."

U.I.E. "Flicker Measurement and Evaluation," 1986

Report to IEC 77A WG6 Committee members, from XITRON Technologies, September 15, 1995

Parts of IEC 1000-3-2, 1000-3-3, 1000-4-7, 868 are reproduced by kind permission of the International Electrotechnical Commission (IEC). Copies of the complete standard may be obtained from IEC, P.O. Box 131, 1211 Geneva 20, Switzerland, Phone: 41 22 919 0228, FAX: 41 22 919 0300 or, in the United States, from the American National Standards Institute, Sales Department, 11 West 42nd Street, New York, NY 10036, Phone: 212 642 4900, FAX: 212 302 1286.

By internet, phone, or fax, get assistance with all your test and measurement needs.

Online Assistance

www.agilent.com/find/assist

Phone or Fax

United States:

(tel) 1 800 452 4844

Canada:

(tel) 1 877 894 4414

(fax) (905) 282 6495

Europe:

(tel) (31 20) 547 2323

(fax) (31 20) 547 2390

Japan:

(tel) (81) 426 56 7832

(fax) (81) 426 56 7840

Latin America:

(tel) (305) 269 7500

(fax) (305) 269 7599

Australia:

(tel) 1 800 629 485

(fax) (61 3) 9210 5947

New Zealand:

(tel) 0 800 738 378

(fax) (64 4) 495 8950

Asia Pacific:

(tel) (852) 3197 7777

(fax) (852) 2506 9284

Product specifications and descriptions in this document subject to change without notice.

Copyright © 1995, 2000 Agilent Technologies

Printed in U.S.A. 10/00

5964-1917E



Agilent Technologies

Innovating the HP Way