

Keysight Technologies

Optimizing Oscilloscope Measurement Accuracy on High-Performance Systems with Keysight Active Probes

Application Note





Introduction

Whether you are designing computer systems, next-generation semiconductors, or communication systems, the huge advances in the processing power of silicon devices have forced engineers to deal with escalating signal rates. To keep high-speed devices supplied with data so they are not sitting idle, designers have been inventing techniques to increase the bandwidth of external buses in order to move large amounts of data between devices on circuit boards, across backplanes, or through cables.

Increasing signal frequency is one way to increase bus bandwidth. As the frequency increases, the rise time of the digital signal decreases. A poor oscilloscope probe can introduce overshoot and ringing on measured waveforms for these fast rise time signals. The engineer must determine if these aberrations are part of the design or if they are caused by the measurement system.

At high speeds, the parasitics introduced when an oscilloscope probe makes contact with a circuit under test can cause significant aberrations on the measured waveform. Also, the probe can create a load on the circuit that can significantly change or disrupt the signal. Understanding how an oscilloscope probe can affect your circuit under test and the measured waveform when you attach the probe will significantly improve your measurement results.

This application note covers the following information that you should consider when selecting an oscilloscope probe to capture high-speed signals:

- Probe input impedance
- Transmitted response of the probe
- Probing accessories
- Oscilloscope and probe system bandwidth

Probe Input Impedance

Oscilloscope designers have made giant strides in improving sample rates, bandwidth, and accuracy. Achieving maximum oscilloscope performance for a particular application, however, requires careful probe selection and operation. Unfortunately, this accessory is frequently overlooked. The probe is the critical link between the circuit under test and the oscilloscope. It affects both your measurement results and the operation of the circuit under test.

When you attach a probe to a circuit, you are effectively adding a load to that circuit. This probe loading draws additional current from the source and changes the operation of the circuitry behind the test point, thereby changing the measured signal.

To attain an accurate measurement, the probe needs to acquire the signal and provide the truest representation of it without excessively loading or otherwise changing the signal source over the entire frequency range of the probe. All probes introduce a complex load to the circuit being measured (figure 1). The goal is to ensure that the effects of this load are kept within acceptable limits.

Probe specifications list input resistance and capacitance, which combine to alter and load a circuit under test. At low frequencies, the capacitor acts like an open circuit and the dc resistance becomes the key factor in circuit loading. Resistive loading is the least worrisome effect of probe loading because it is unlikely to produce nonlinear circuit behavior.

Although excessive current drain from a low impedance probe can cause nonlinear response or disrupt the operation of your circuit, this typically isn't a problem on today's low-voltage, high-speed signals when you use a probe. Such as the Keysight Technologies, Inc. InfiniiMax probes, N2795A/96A or 1156A/57A/58A.

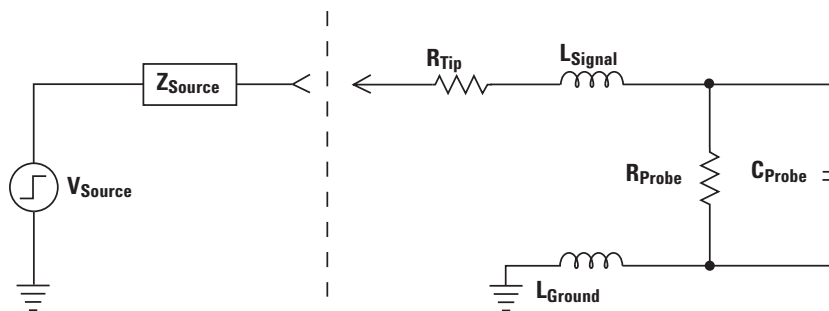

Figure 1. Simple input impedance model of an oscilloscope probe comprised of resistive, capacitive, and inductive elements.

Probe Input Impedance

Assuming the source impedance is resistive, the probe's resistive component creates a voltage divider—consisting of your circuit's output resistance and the probe input resistance—that reduces the voltage amplitude of the measured signal without altering its shape (figure-2). The lower the probe resistance relative to the source resistance, the more the probe loading reduces the voltage amplitude of the measured waveform. Additionally, the lower the probe resistance relative to the circuit, the more current that must flow into the probe, increasing the chance that your circuit will be adversely affected.

As signal frequencies increase or edge speeds decrease, probe capacitance behaves like a short circuit, allowing current to flow through the probe with low impedance. At high frequencies this capacitive reactance becomes a significant factor in circuit loading and may cause your circuit to fault because it is unable to drive adequate voltage margins.

Capacitive loading is a major source of probe-related measurement errors because it affects rise and fall time, bandwidth, and edge-to-edge timing measurements. Capacitive loading alters the shape of the measured waveform by introducing an exponential response (figure 3), which can attenuate glitches, reduce ringing and overshoot, or slow the measured edge just enough to create setup or hold time violations in your circuit.

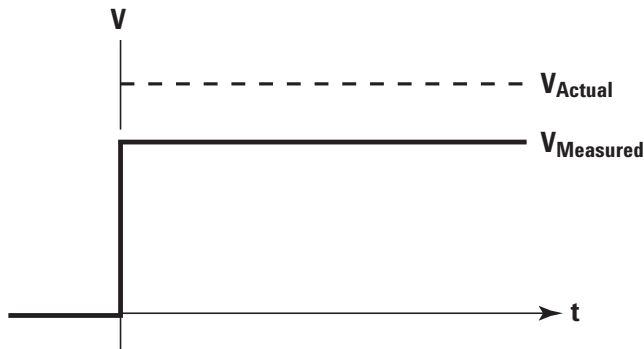

Figure 2. Resistive loading reduces the amplitude of the measured signal without altering the shape.

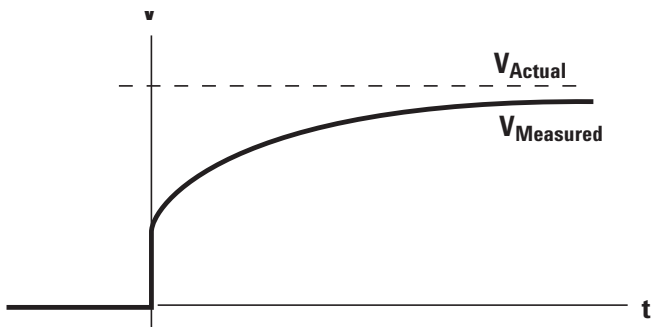

Figure 3. Capacitive loading alters the shape of the waveform by introducing an exponential response.

Probe Input Impedance

Figure 4 illustrates the Keysight 1158A probe input impedance up to 6 GHz. You can see that at low frequencies up to 1-MHz the probe input impedance is dominated by the probe's dc resistive component (100 k Ω). As the signal frequencies increase, the capacitive reactance becomes the significant component in loading the circuit. At 2-GHz the Keysight 1158A reaches its minimum impedance of 165- Ω , which is limited by the probe's tip resistor.

As an example of how this will affect your measured waveform and your circuit under test, let's look at a digital signal with a very fast edge from a 25- Ω source (figure 5). You can see that when the probe is attached the signal is changed due to the input impedance of the probe.

Inductive loading appears as ringing in the measured signal (figure-6). The source of this ringing is the LC circuit, which is comprised of the probe's internal capacitance and the inductance from the ground lead and the probe tip. As a rule, when making any kind of oscilloscope measurement, you should use the shortest possible ground lead. This will reduce the inductance and should move the ring frequency beyond the bandwidth of the oscilloscope and probe to minimize the effect on your measurements.

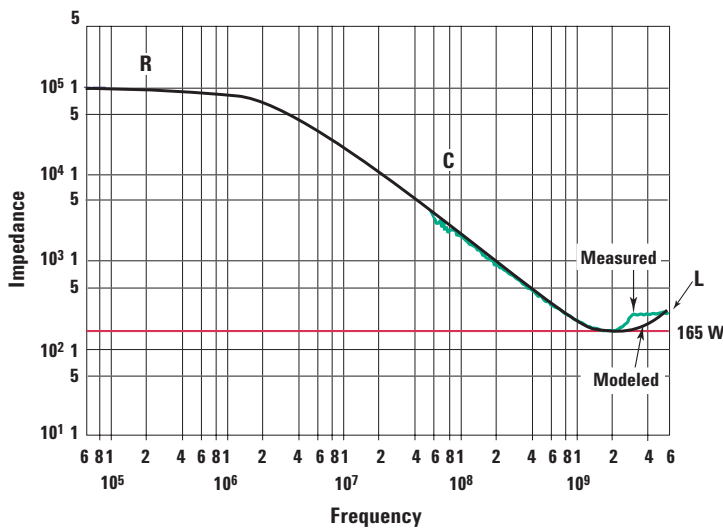

Figure 4. Increasing frequency changes the input impedance of the Keysight 1158A probe.

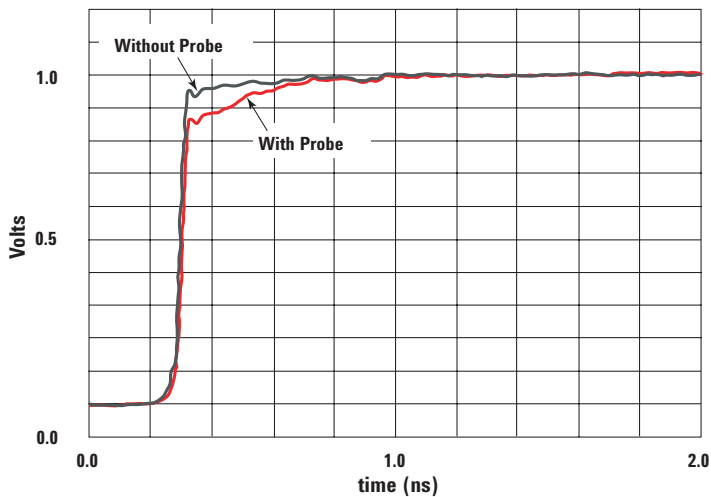

Figure 5. Probes load the circuit at high frequencies and increase the time to drive the circuit to full voltage.

Transmitted Response of the Probe

Parasitic elements that affect probe input impedance also alter the probe's transmitted response, often referred to as the frequency response of the probe. The transmitted response is defined as the ratio of the voltage at the probe output divided by the voltage at the probe input (V_{out}/V_{in}). This is usually shown on a graph with amplitude, expressed in dB, versus frequency.

The probe bandwidth is the continuous band of frequencies up to the point where the transmitted response is down -3-dB, or where the amplitude has fallen to 70.7% (figure-6). Beyond the bandwidth of the probe, signal amplitudes become overly attenuated and measurements become unpredictable.

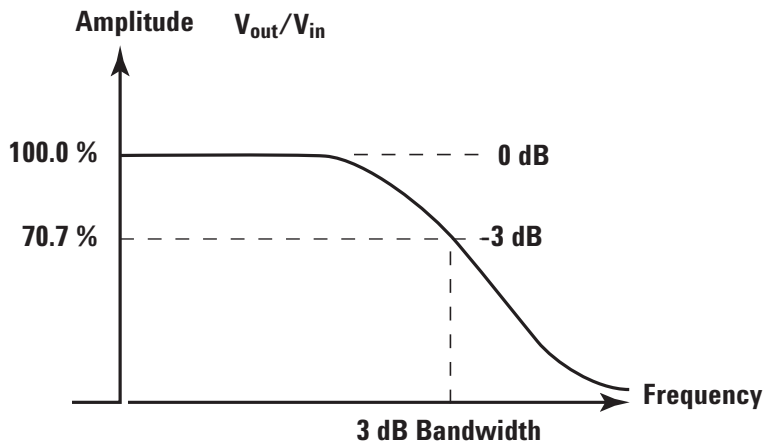

Figure 6. Bandwidth is defined as the continuous band of frequencies up to the point where the instrument's transmitted response decreases by 3 dB.

Transmitted Response of the Probe

Within the probe bandwidth, you would like to see the signal at the probe's output closely track the signal at the probe tip with minimal degradation. This allows you to see on the oscilloscope screen exactly what the signal looks like at the probe tip.

In the frequency domain, the ability of the probe to transmit the signal from input to output with minimal degradation appears as a flat transmitted response (0-dB) throughout the entire bandwidth of the probe. In practice, this is difficult to achieve. When a probe is attached to the circuit under test, the parasitics of the physical connection and the internal components of the probe can form a resonant circuit whose resonant frequency can be lower than the bandwidth of the probe (figure-7). This in-band resonance will cause the output of the probe to differ from the input and can show up as overshoot and ringing on your measured waveform.

The example in figure-7 illustrates the in-band resonance on the input voltage (V_{in}) of a non-Keysight 4-GHz probe. Note that the output of the probe (V_{out}) does not track the voltage at the input. V_{out} remains flat and the transmitted response of the probe (V_{out}/V_{in}) is peaked by 5-dB.

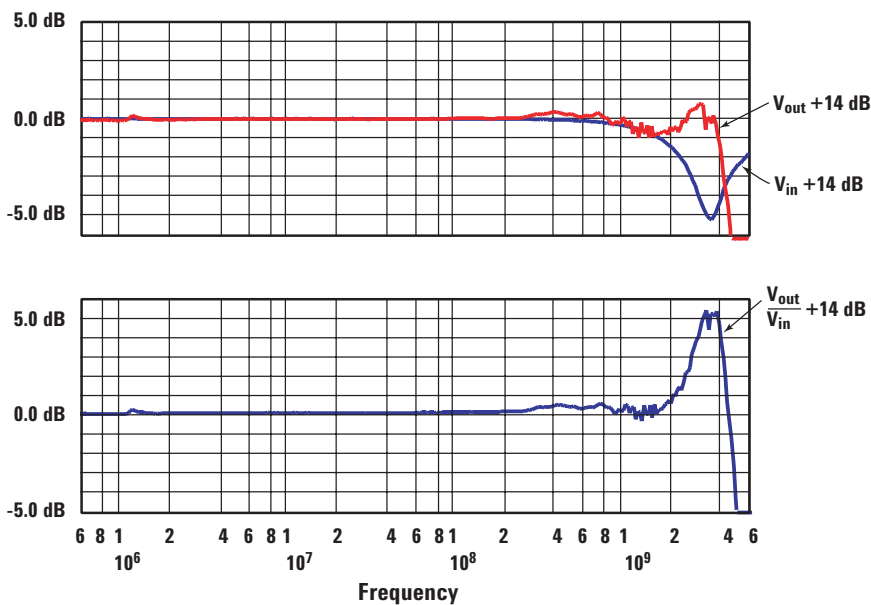

Figure 7. (Top) Frequency response of V_{in} and V_{out} of a non-Keysight, 4 GHz probe in a 25- Ω system. (Bottom) Transmitted response of the probe. V_{in} resonates low at 3.5-GHz, V_{out} remains flat and the transmitted response is peaked by 5-dB.

Transmitted Response of the Probe

So what's wrong with V_{out} remaining flat when V_{in} resonates, doesn't this just show what the signal would look like without the probe attached? This is a great question, but you must remember that this probe's transmitted response will always be peaked by 5-dB, which distorts the signal at the input and can show up as additional overshoot and ringing on your measured waveforms.

The measurement in figure-8 was made in the middle of a dual terminated 50- Ω transmission line, which appears as a 25- Ω source resistance, and the probe's response is matched to this type of circuit. If you are measuring any circuit that does not provide a perfect 25- Ω source resistance, you will notice the distortion introduced from the probe.

An example of this type of distortion may provide a better explanation. Assume that you are using a 100-k Ω probe to measure the voltage on a circuit that has a 100-k Ω source resistance. The probe's transmitted response has been altered for this type of circuit to show you the "actual" voltage at the output of the probe. Therefore, when you attach the probe to the circuit and the input voltage drops by one-half, the measured waveform shows the full voltage amplitude as though the probe were not attached.

But what happens now when you attach the probe to a circuit with a 50-k Ω source resistance? The probe's transmitted response will still alter the measured waveform and will display a waveform with a voltage that is 33% greater than actually occurs at the input to the probe.

The best a probe can do is to minimize the impact it has on the circuit under test and transmit the voltage at its input to its output with minimal distortion. This way you can view what your signal looks like at the probe's tip.

The Keysight 1156A/57A/58A probes have solved this problem by placing a resistor as close to the point being probed as possible. Placing a resistance at the probe tip isolates the parasitics of the probe from the circuit under test and dampens the resonant circuit that is formed. This keeps the transmitted response (V_{out}/V_{in}) of the probe flat across the entire bandwidth to 4-GHz (figure-8).

As a rule, when you need to make accurate rise time measurements use the shortest ground lead possible.

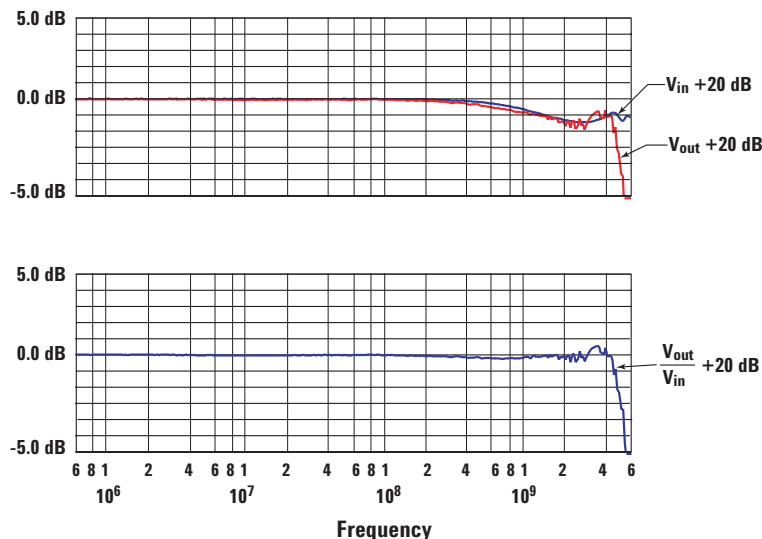

Figure 8. (Top) Frequency response of V_{in} and V_{out} of the Keysight 1158A, 4 GHz probe. (Bottom) Since the frequency response of V_{out} closely tracks V_{in} , the transmitted response of the probe remains flat throughout the 4 GHz bandwidth of the probe.

Probe Accessories

Because of the challenges involved with probing circuits, it is not always feasible to directly attach the probe to the signal and ground. That is why it is common to see short lengths of wire soldered to points on a circuit to facilitate these connections. However, the increased parasitics from these wires dramatically changes the probe's transmitted response, thereby introducing overshoot and ringing into your measured waveform (figure-9). Generally, wires that are used to extend the reach of a probe will introduce as much as 25-nH of inductance per inch into the probe equivalent circuit.

So how do you evaluate those signals that are located on your board where probe access is impossible?

Most high-performance probes provide accessories that are designed to make the physical connection but lack the electrical characteristics to transmit high-fidelity signals.

Keysight understands that the probe and its accessories form a cohesive system. For this reason, the Keysight 1156A/57A/58A probes provide a variety of accessories to help you make these difficult connections and are properly damped electrically to optimize the performance of your measurements. In order to make informed decisions when you trade measurement bandwidth for a physical connection, Keysight has characterized the 1156A/57A/58A accessories and includes this information with the probes.

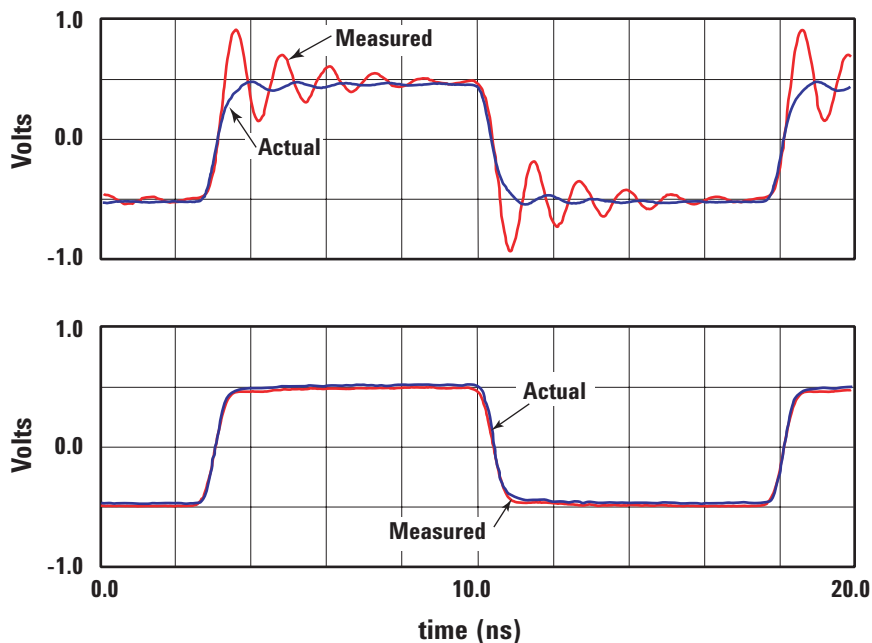

Figure 9. Measurements taken on a 66 MHz/500-ps clock. (Top) Plain 5-cm wire attached to the signal under test creates overshoot and ringing on the measured waveform. (Bottom) Properly damped 5-cm resistive signal lead extends the reach of the probe into tight spaces without adding distortion into the measured waveform.

Probe Accessories

For example, the Keysight 1156A/57A/58A probes provide 5-cm and 10-cm resistive signal leads that can be used to extend the reach of the probe into tight spaces (figure-10). These signal leads contain a resistive tip to isolate the parasitics of the probe from the circuit under test and dampen the resonant circuit that is formed.

This creates a transmitted response that is flat over the bandwidth of the new probing configuration (figure-11). Finally you are able to make measurements on difficult to reach signals without introducing additional overshoot, ringing, and other distortions into the measured waveform!

Remember it is important to keep the length of the ground connection as short as possible. When a ground lead is attached to a probe, inductance is added into the probe's return path, which is not compensated for in the probe. This additional inductance will alter the probe's transmitted response and introduce distortion into your measured waveforms.

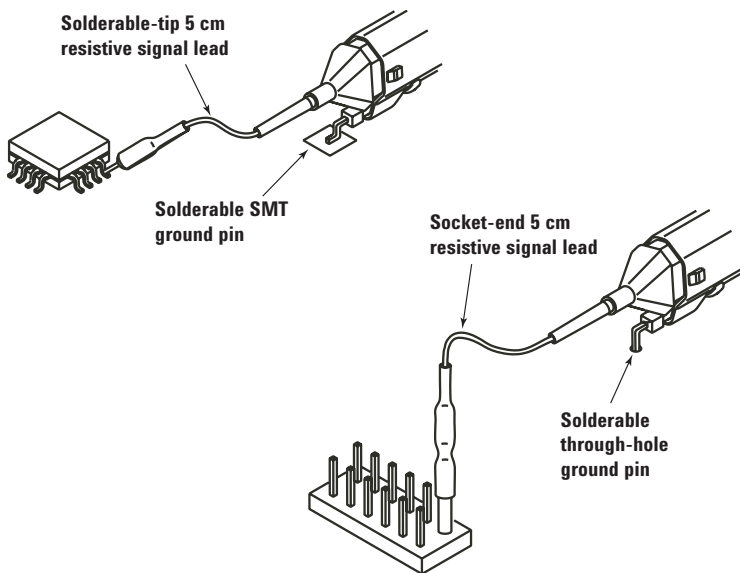

Figure 10. Probing with the Keysight 1156A/57A/58A probes and properly damped accessories increases measurement reliability.

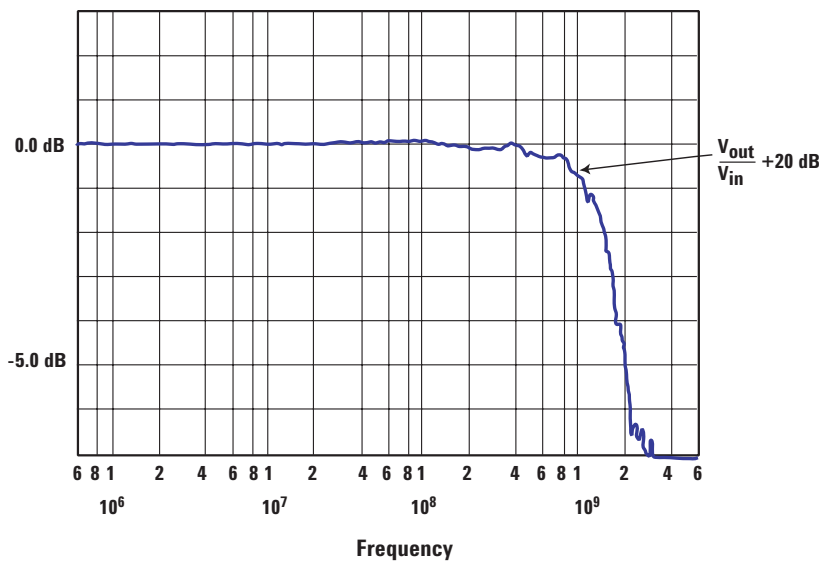

Figure 11. Probing with the 5-cm resistive signal leads for the Keysight 1158A probe will reduce the bandwidth of the measurement, but the transmitted response remains flat and no distortion is introduced into the measured waveform.

Bandwidth and Rise Time Considerations

Bandwidth limitations are important to understand when selecting oscilloscopes and probes because of their implications for measurement accuracy. Bandwidth is defined as the frequency where the measurement system's transmitted response causes the output amplitude to fall -3-dB (70.7%) from its reference level (figure-6). So how much bandwidth do your oscilloscope and probe need?

A signal transmitted by a continuous sine wave consists of a single frequency component, its fundamental frequency. As the frequency of a sine wave approaches the bandwidth limit of the measurement system, the measured amplitude becomes more attenuated. At the bandwidth of the system, you can expect a 30% error in the amplitude of the measured sine wave. For this reason, when you are making accurate amplitude measurements, you should select an oscilloscope and probe system with a minimum bandwidth that is three times greater than the fundamental frequency of the signal.

Unlike sinusoidal signals, where the frequency content is comprised of a single component, digital signals contain broad spectral content across multiple frequencies to create the fast edge speeds that make up a square wave. For digital signals, the spectral content is determined primarily by edge speeds, not the signal's repetition rate. A conservative estimate of the edge frequencies of a digital signal is:

$$F = 0.5/(\text{Rise Time})$$

Generally, this will estimate a slightly higher frequency than actually exists.

Digital signals also have significant spectral content located at the 3rd and 5th frequency harmonics. Attenuation of these high-frequency components will result in measured rise and fall times appearing slower than they actually are. Therefore, to increase the accuracy of rise and fall time measurements you should choose an oscilloscope and probe bandwidth that is three or five times greater than the rise time frequency of the digital signal.

Bandwidth and Rise Time Considerations

Now that we understand the bandwidth requirements to accurately capture our signals, how do we determine the system bandwidth for our oscilloscope and probe?

All probes have a bandwidth limit, thus there is an inherent minimum signal rise time that can pass through the probe that can be estimated using the formula:

$$\text{Rise Time} = 0.35/\text{Bandwidth}$$

Rise time is the time required for a waveform to change from 10% to 90% of its final value. The probe's minimum rise and fall time will be listed in your probe characteristics and denotes the output of the probe when the input is a perfect step with zero rise time. This is illustrated by looking at the signal at the input and the output of the Keysight 1158A probe (figure 12).

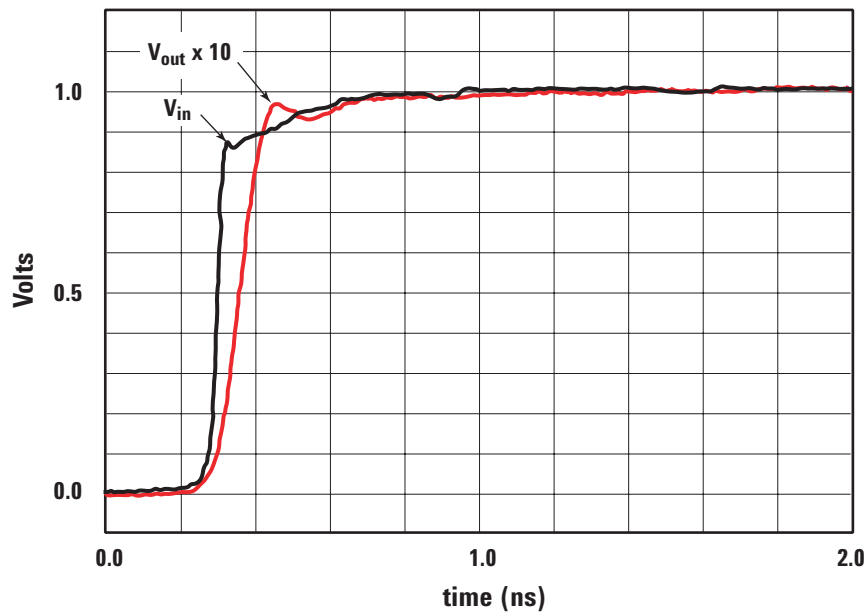

Figure 12. A probe's minimum rise-time can affect your measurements.

Bandwidth and Rise Time Considerations

Your oscilloscope will also have its own separate bandwidth and rise time limits. It is commonly assumed that the bandwidth of the oscilloscope and the probe should be equal in magnitude. However, the relationship between the oscilloscope bandwidth and the probe bandwidth is not that simple.

The oscilloscope and probe combine to form a measurement system, which is comprised of the transmitted response of the probe in series with the transmitted response of the oscilloscope. The combination of these responses will determine your measurement system's rise time and bandwidth, which are commonly calculated using the following equations:

$$\text{System Rise Time} = \sqrt{(\text{tr}(\text{scope})^2 + \text{tr}(\text{probe})^2)}$$

And

$$\text{System Bandwidth} = 0.35 / (\text{System Rise Time})$$

Where

$\text{tr}(\text{scope})$ = Rise Time of the Oscilloscope

$\text{tr}(\text{probe})$ = Rise Time of the Probe

These equations are good estimates for system bandwidth and rise time when the oscilloscope and probe responses roll off in a Gaussian manner (figure-13).

When the response differs from Gaussian, you must take a closer look at the response of the probe to understand how the signal is transmitted from the probe tip to the oscilloscope input. As long as the probe's response is flat, $V_{\text{out}}/V_{\text{in}} = 0\text{-dB}$, the signal transmitted to the oscilloscope input will be an exact duplicate of the signal at the probe tip.

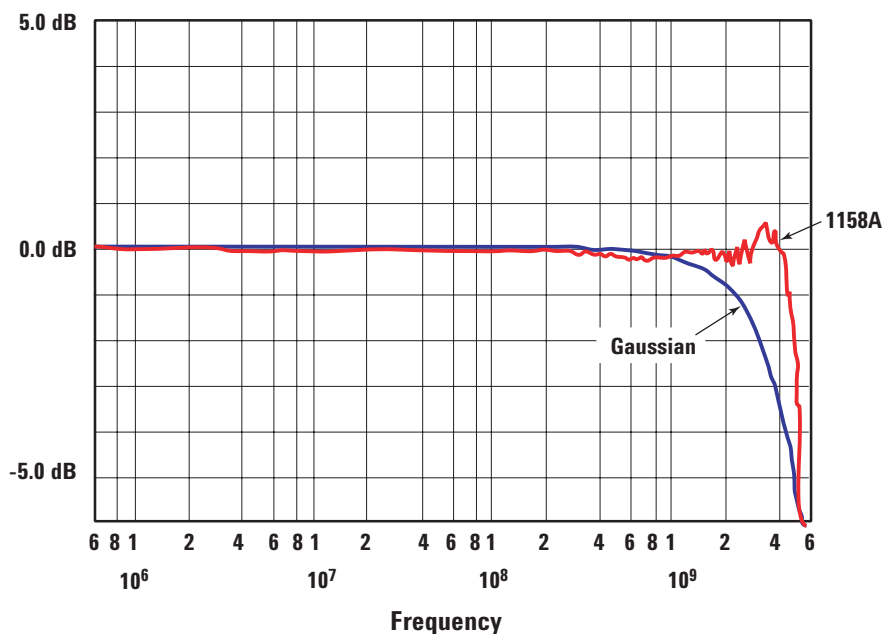

Figure 13. Comparison of Gaussian transmitted response and the steep roll-off of the Keysight 1158A probe.

Bandwidth and Rise Time Considerations

Keysight used this concept of maximally flat response in the development of the 1156A/57A/58A probes. Figure-14 illustrates the transmitted responses for these probes.

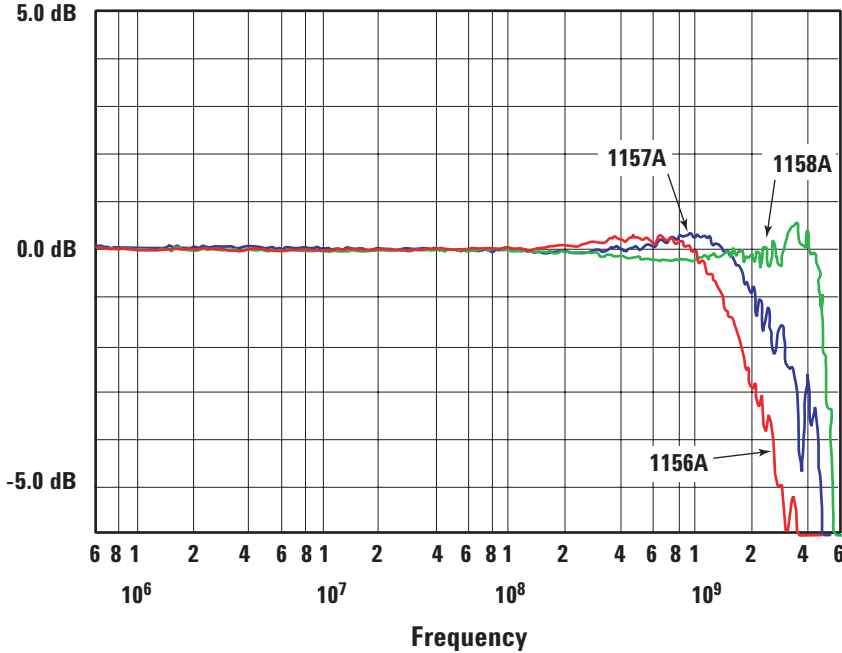

Figure 14. Transmitted response of the Keysight 1156A (1.5-GHz), 1157A (2.5-GHz), and 1158A (4-GHz) probes.

Oscilloscopes	Recommended probes	System bandwidth
InfiniiVision and Infiniium 500 – 600 MHz models	N2795A 1 GHz	500 - 600 MHz
InfiniiVision and Infiniium 1 GHz models	N2796A 2 GHz or 1130A 1.5 GHz	1 GHz
Infiniium 2.5 GHz	1157A 2.5 GHz or 1131A 3.5 GHz	2.5 GHz
Infiniium 4 GHz	1158A 4 GHz or 1132A 5 GHz	4 GHz

For other higher bandwidth models, refer to the [Keysight.com](https://www.keysight.com) for the recommended active probes.

Table 1. Recommended configurations to maximize your measurement system’s bandwidth.

Table-1 provides information on the recommended probe configuration for an Infiniium oscilloscope to maximize your measurement system’s bandwidth. You will notice that since the probe’s transmitted response remains flat throughout the Infiniium oscilloscope’s bandwidth, there is no degradation of system bandwidth due to the probe.

Conclusions

As the frequencies of electronic devices continue to increase, the oscilloscope probe you select becomes crucial to your measurement results and the operation of your circuit under test.

The following factors should be considered when selecting your next probe:

1. Check the probe input impedance and consider the effect it will have on your circuit. Remember, loading becomes increasingly important at high frequencies, and use a short ground lead when possible.
2. The probe will introduce distortion into your measurements unless it has a flat transmitted response throughout the bandwidth of the probe.
A flat transmitted response will closely track the signal at the probe tip and pass it to the oscilloscope with minimal degradation.
3. Your best measurements can never be better than your probe and connection, so wisely choosing and using probes with properly damped accessories will improve your measurement results and their repeatability.
4. The oscilloscope and probe work together to form a cohesive measurement system. Understanding the impact of your probe on your overall system bandwidth provides you with the information you need to pick the right oscilloscope and probe for your application.

The best a probe can do is to minimize the impact it has on the circuit under test and transmit the voltage at its input to its output with minimal distortion. The Keysight 1156A/57A/58A probes provide leading-edge performance and the most accurate insight into your high-speed circuits.

Related Literature

Publication Title	Publication Type	Publication Number
Keysight 1156A/57A/58A Active Probes	Product overview	5988-3361EN/EUS
Keysight Oscilloscope Probes	Selection guide	5989-6162EN and Accessories
Eight Hints for Better Probing	Application note	5989-7894EN

myKeysight

myKeysight

www.keysight.com/find/mykeysight

A personalized view into the information most relevant to you.



www.axiestandard.org

AdvancedTCA® Extensions for Instrumentation and Test (AXIe) is an open standard that extends the AdvancedTCA for general purpose and semiconductor test. Keysight is a founding member of the AXIe consortium. ATCA®, AdvancedTCA®, and the ATCA logo are registered US trademarks of the PCI Industrial Computer Manufacturers Group.



www.lxistandard.org

LAN eXtensions for Instruments puts the power of Ethernet and the Web inside your test systems. Keysight is a founding member of the LXI consortium.



www.pxisa.org

PCI eXtensions for Instrumentation (PXI) modular instrumentation delivers a rugged, PC-based high-performance measurement and automation system.



Three-Year Warranty

www.keysight.com/find/ThreeYearWarranty

Keysight's commitment to superior product quality and lower total cost of ownership. The only test and measurement company with three-year warranty standard on all instruments, worldwide.



Keysight Assurance Plans

www.keysight.com/find/AssurancePlans

Up to five years of protection and no budgetary surprises to ensure your instruments are operating to specification so you can rely on accurate measurements.



www.keysight.com/go/quality

Keysight Technologies, Inc.
DEKRA Certified ISO 9001:2008
Quality Management System

Keysight Channel Partners

www.keysight.com/find/channelpartners

Get the best of both worlds: Keysight's measurement expertise and product breadth, combined with channel partner convenience.

This document was formally known as Application Note 1385.

For more information on Keysight Technologies' products, applications or services, please contact your local Keysight office. The complete list is available at: www.keysight.com/find/contactus

Americas

Canada	(877) 894 4414
Brazil	55 11 3351 7010
Mexico	001 800 254 2440
United States	(800) 829 4444

Asia Pacific

Australia	1 800 629 485
China	800 810 0189
Hong Kong	800 938 693
India	1 800 112 929
Japan	0120 (421) 345
Korea	080 769 0800
Malaysia	1 800 888 848
Singapore	1 800 375 8100
Taiwan	0800 047 866
Other AP Countries	(65) 6375 8100

Europe & Middle East

Austria	0800 001122
Belgium	0800 58580
Finland	0800 523252
France	0805 980333
Germany	0800 6270999
Ireland	1800 832700
Israel	1 809 343051
Italy	800 599100
Luxembourg	+32 800 58580
Netherlands	0800 0233200
Russia	8800 5009286
Spain	800 000154
Sweden	0200 882255
Switzerland	0800 805353
	Opt. 1 (DE)
	Opt. 2 (FR)
	Opt. 3 (IT)
United Kingdom	0800 0260637

For other unlisted countries:
www.keysight.com/find/contactus
(BP-09-23-14)