

***Bluetooth*[®] Manufacturing Test
A Guide to Getting Started**

Application Note 1333-4



Agilent Technologies

This application note is designed for electronic design/test engineers and managers who plan to manufacture products using *Bluetooth* wireless technology. It is addressed to a wide audience whose technical skills and knowledge may vary and therefore assumes no special knowledge of radio frequency (RF) techniques. For those who wish to explore the topics covered herein further, additional references are given in the Appendices.

Table of Contents

1. Introduction	2
2. <i>Bluetooth</i> Manufacturing Overview	4
2.1 The manufacturing environment	4
2.2 High-volume testing	4
2.3 Low cost orientation	4
2.4 Reasons to test	5
3. The Test Process	6
3.1 Business strategy and approach considerations	6
3.2 The manufacturing test process	7
4. Creating the <i>Bluetooth</i> Test Plan	8
4.1 Factors in creating a test plan	8
4.2 <i>Bluetooth</i> manufacturing stages	9
4.3 Test plan factors	10
4.4 Testing the product in a production chain	10
4.5 Researching test plan	10
5. <i>Bluetooth</i> Tests	11
5.1 Transmitter tests	11
5.2 EDR transmitter tests	13
5.3 Receiver tests	13
5.4 EDR receiver tests	14
5.5 Other <i>Bluetooth</i> tests	14
5.6 Priority of <i>Bluetooth</i> tests	14
6. Creating the Test Plan	15
6.1 Combining <i>Bluetooth</i> standard and EDR tests	15
6.2 Choosing test plans for <i>Bluetooth</i> 2.0 EDR devices	15
6.3 Choosing a test plan for <i>Bluetooth</i> 1.2 devices	16
6.4 Frequency hopping	16
6.5 Modulation types	17
6.6 Test order	17
6.7 Test parameters	17
6.8 BER measurements	18
6.9 Functional testing	18
7. Other Important Manufacturing Issues	19
Appendix A: Measurement Setup	20
Appendix B: <i>Bluetooth</i> Radio Topology	21
Appendix C: Test Line Limit	22
Appendix D: Agilent Solutions for <i>Bluetooth</i> Wireless Technology	24
Appendix E: References and Further Reading	25

1. Introduction

Bluetooth technology is an exciting platform that offers wireless connectivity to an expanding array of electronic devices – computers, laptops, personal digital assistants (PDAs), digital cameras, cell phones, and wireless headsets. Personal area networks can now be created on an ad hoc or semi-permanent basis with no cables or connectors and only minimal network administration efforts.

Bluetooth frequencies occupy the 2.4 GHz ISM (Industrial, Scientific, and Medical) band. This unlicensed portion of the radio spectrum is increasingly being filled by microwave ovens and other RF technologies, the most well-known being IEEE 802.11b. As the ISM band becomes more widely used, radio interference will no doubt increase. To counter this, *Bluetooth* technology uses several innovative techniques to provide stable linkages, among them cyclical redundancy encoding, re-transmission of data packets, and frequency hopping at up to 1600 times per second. *Bluetooth* devices can achieve data rates of up to 1 Mb/s with the *Bluetooth* 1.2 standard and the *Bluetooth* 2.0 standard can achieve data rates of up to 3 Mb/s. Originally created as a simple cable replacement, *Bluetooth* connectivity has become much more – users are increasingly seeking wireless capability in their workplaces and homes.

Building a test system for *Bluetooth*-enabled products rolling down a manufacturing line would be easy if there were no design or test restrictions on the engineer. In the real world, however, we must deal with issues such as product size, throughput (which affects time-to market), and cost. Addressing these issues and knowing the specific business strategies your company adopts will help you create a test system and plan that is efficient and cost-effective for your application.

This application note introduces you to the *Bluetooth* manufacturing environment, cites the many good reasons to test, discusses high-level business considerations, and shows you step-by-step how a *Bluetooth* test plan is created. The Appendices give you detailed information on test methods and conditions, implications of *Bluetooth* radio design, important manufacturing issues, and descriptions of Agilent products for *Bluetooth* testing. By learning the principles and procedures herein and customizing them to your use, you will be able to create a test plan that is best suited to your company, product, and target market.

To help you in product development and testing, the *Bluetooth* Special Interest Group (SIG) maintains an official *Bluetooth* Web site, www.bluetooth.com, which is regularly updated with new and helpful information. Agilent's own *Bluetooth* Web site can be found at www.agilent.com/find/bluetooth, which offers both technical information and product descriptions. A wide range of articles, press releases, application notes, and other information is also available on the Web site.

2. *Bluetooth* Manufacturing Overview

Bluetooth technology presents a major challenge to manufacturers. As a wireless medium, it contains RF complexities and problems that wired systems do not. It comes in many implementations, from wireless peripherals to local area networks, to cellular phones. Moreover, market realities dictate that most *Bluetooth* devices must be manufactured at both high volume and low cost. All of these factors will clearly influence the approach engineers take not only to manufacturing, but also to test.

2.1 The manufacturing environment

Several methods for adding *Bluetooth* technology to a product are currently available:

1. Creating the entire design, including *Bluetooth* capability, from the ground up
2. Buying *Bluetooth* integrated circuits or chips and designing them into the product
3. Installing pre-manufactured, pre-tested *Bluetooth* modules from other vendors
4. Buying hardware that contains the *Bluetooth* capability and complementing your own design

In terms of testing, much overlap occurs in these approaches. Whether you are manufacturing *Bluetooth* modules, larger sub-assemblies with *Bluetooth* capability, or fully-functional products for the end user, many of the same test issues will apply, including device verification and design/performance expectations. It is impossible to state simply which alternative you should choose. It will depend on many factors, such as economies of scale, availability of outside products, probability and type of process errors, and the level of RF expertise in your company.

2.2 High-volume testing

For high-volume products, you should strongly consider automating your *Bluetooth* device testing. This usually involves developing custom fixtures and a sophisticated materials-handling system, so that test connections can be made automatically. The primary enabler of high volume is short test times (i.e. high throughput), with a reasonable goal being less than 10 seconds per manufactured unit. For low-volume products, you may be better served by choosing a manual connection (with or without automated testing), where results come in a minute or two rather than a few seconds.

Another decision in high-volume operation is whether to test products in a single-site (one at a time) or multi-site (several at a time) fashion. If multi-site, the issue then arises of whether to test in sequence or in parallel. High volume products are almost always tested in a multi-site fashion, with several devices under test (DUTs) being presented to the test station simultaneously. These could be tested in parallel, which calls for more complex fixtures, or sequentially, which reduces the test resources required but also means greater calibration and switching complexity. Yet another consideration is the type and diversity of products and fixtures the test station will encounter: will different types and complexities of products be coming out in the future, putting more stress on the test environment, or will products remain largely the same?

In short, if the test system and test suite meet your time requirements and support your quality and profit goals, they can be considered successful.

2.3 Low cost orientation

In order to make a product, you need both materials and processes to put the product together. *Bluetooth* products also incorporate a non-material content (bits) that governs the product's behavior.

The objective of making a product must be coordinated with that of making a profit. To do this, you should strive for an optimum efficiency at which per-product manufacturing cost falls well below the price of the product. Profit must take into account the costs of materials, manufacturing processes, tests, and customer support (returns, repairs, warranties, etc.)

A design or test engineer can do little about most of these, but minimizing manufacturing cost by minimizing test cost is a constant and primary goal – balanced, of course, by confidence in the product's quality.

2.4 Reasons to test

Among the many compelling reasons to test *Bluetooth* products are the following:

2.4.1 Completing product functionality

Bluetooth products are sophisticated RF communication devices with complex software that drives their operation. One element of software is the 'protocol stack,' which is usually downloaded during manufacturing. Other 'soft' components may also be required for complete functionality – e.g., the unique *Bluetooth* identifier for each product. These need to be installed during the manufacturing process at a time when they are most supportive of the overall test approach.

2.4.2 Component or subsystem alignment

Bluetooth and other communication systems usually require some kind of component or subsystem alignment before operating as a complete unit – e.g., crystal tuning for output frequency accuracy, output power adjustment for battery longevity, power step accuracy to meet specifications, and received signal strength calibration. All of these are part of dynamically adjusting the total RF link characteristics, without which proper unit operation in the field is impossible.

2.4.3 Performance verification

At some point, *Bluetooth* system designs must be measured for compliance to the *Bluetooth* specification. Once the *Bluetooth* test specification has been met then it is up to the manufacturer to decide what testing should be done on the device to ensure that it is functioning correctly. This enables a large degree of flexibility when testing the *Bluetooth* device. The *Bluetooth* device testing should create a high level of confidence that the design will meet the *Bluetooth* standards. Among the parameters to measure are modulation accuracy, sensitivity, power output, and various spectrum measurements. Together with confidence in the overall quality (processes and materials), testing will help guarantee that the product is reliable, has the proper operating range, and will satisfy the customer.

2.4.4 Primary use case

Verifying that an electronic product operates at least approximately the way the customer will use it – i.e., the 'primary use case' – may be critical to the ultimate success of the product. In the case of a *Bluetooth*-enabled product, this means that it must join a piconet (two to eight *Bluetooth* devices linked together) in its normal role of master unit, slave unit, or both. It also means that it will be fully functional within that context, performing as expected. Only full functionality tests (many of which are non-*Bluetooth*) will be able to verify total performance.

2.4.5 Material defect and process error screening

Material defect and process error screening involves the identification of device failures due to aberrant performance because of shifts, long-term drift in components, or process tolerance failures. While originating with the supplier of the components (and its particular process deviations), such defects are still the responsibility of the manufacturing test engineer – they must be addressed and eliminated.

2.4.6 Quality assurance

Quality assurance testing is directed toward:

- Integrity and improvement of the manufacturing process, including data gathering and statistical process control
- Continued verification of correlated performances to confirm test plan assumptions or derive new correlations
- Ongoing verification of product conformance to the *Bluetooth* standard or FCC/ETSI regulations

The final four reasons for testing – performance verification, product functionality, material and process defects, and quality assurance – are drivers of the cost minimization process discussed above. The first two, completing product functionality and product alignment, are considered “test” processes in that they add value similar to that of material assembly processes. For example, defect screens should always be regarded as temporary because they represent material or processes which can be moved to a higher quality level. Quality assurance may take several forms, one being full sample testing, either on or off the production line, to ensure that all processes, materials, and designs are under control.

3. The Test Process

3.1 Business strategy and approach considerations

Strategic and business goals will affect everything done in a manufacturing process. So a thorough understanding of one’s business environment and goals is prerequisite to creating a test system and processes. Each business environment is unique, so no attempt will be made to cover them in detail.

However, most design and test engineers will consider several common factors: product type, target market, material automation, test time, test budget, product volume, floor space, data handling for decision support, data handling for customer service, operator requirements (user interface, ergonomics, safety, etc.), company infrastructure, and business goals and objectives.

Each of these will place constraints on the test environment and processes – not to mention the test engineer! For example, if your company markets a popular consumer device for which high volume is necessary, test speed will be paramount. If equipment cost is critical, functionality versus cost-of-test will be key. If credibility or reliable performance under stress is critical, demonstrable performance under test will be the goal. The most common and important of these objectives will be speed and cost.

3.2 The manufacturing test process

Figure 1 depicts the flow of the manufacturing test process at a very high level. It provides an excellent starting point to work through the complexities of the test process and move into more detail. The illustration shows what happens at the factory level – material flows in, is connected, tested, verified (compared to a benchmark), and then shipped out after test results are stored to a database. When we approach the test process this way, we have to consider not only the test plan and test station design – the initial goal – but also product delivery to the station, the method of interconnection to the station (not shown), specification comparison, data storage, and product exit. In the diagram, the test plan is further expanded into product turn-on, initialize, calibration, parametric, and functional. Product calibration and measurement issues will be the chief drivers of overall test system design. Not shown but implied are test environment issues, such as test station design, software drivers, and fixtures.

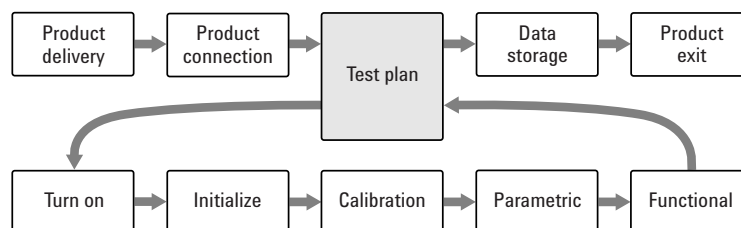

Figure 1. Overview of possible stages in manufacturing environment.

3.2.1 Product connection to test system (fixturing)

Since the test system contains the stimulus-and-response instrument(s) and support – cables, interfaces, switches, etc. – a mechanism is required to connect the DUT to the system. This is the test fixture. Depending on product complexity and functionality, a fixture can be very simple or as sophisticated as the test system itself! Two factors will dictate design of the fixture. The first is input/output (IO). IO connections are needed for power, control, audio, and RF signals. The second factor is throughput, where the decision to test in multi-up fashion or not is key. Issues affecting this decision include whether switching is located in the test station or the fixture, speed of the connection, automatic versus manual feed, isolation between IO lines, and fixture maintenance.

It is important for the manufacturer to know the loss factor from the test setup on the manufacturing line. This can affect results if there is a high level of loss, so it is important to compensate for any factors that may influence the test. An RF cable connector can lose around 2 dB so this, with other loss factors, if not compensated for, could produce a large fail yield of the product.

Another setup that is sometimes more practical when doing high volume manufacturing is to use an RF link to test the device. This can cause problems because of interference in the test environment. Consequently, when planning this type of setup, it is very important to design a good shielded test cage where a good RF link can be established between the tester and the test set. This setup will model a Rician channel so some interference will still occur during testing. In a normal operating environment the Rician channel is the type of interference that the device will normally operate.

3.2.3 Result comparison

A test verdict is given when the numerical result of each test is compared to a pre-determined test line limit (TLL) – pass or fail. The TLL is considered part of the test plan. It is established through an independent process, so it is discussed separately (Appendix C). The process of setting a TLL takes into account production statistics, desired yield, measurement uncertainties, and characteristics of design such as variation over temperature or humidity.

4. Factors of the *Bluetooth* Test Plan

Customers will judge the performance of *Bluetooth* products based on factors such as range, transfer speed, and reliability of operation. Optimized testing in manufacturing will ensure that their expectations are met. This section will identify a range of potential tests which can be used during manufacturing. It discusses how to evaluate the importance of potential tests and discusses the optimum conditions for using them. Many of these tests can be implemented in test mode, which gives an engineer or operator the ability to initialize and control a *Bluetooth* device over the RF or host controller interface (HCI).

4.1 Factors in creating a test plan

Until now, we have had primarily a factory perspective in describing the test process, but testing is only the culmination of a long development process, which includes all aspects of the value chain. Figure 2 depicts the factors that influence the creation and implementation of an effective test plan.

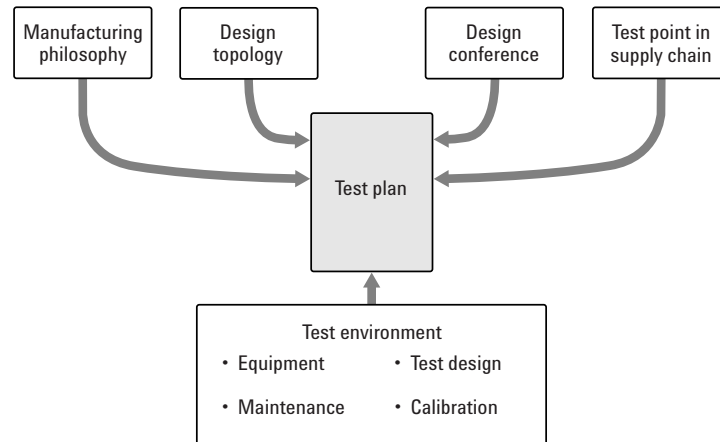

Figure 2. Factors in creating and implementing a *Bluetooth* test plan.

Figure 2 shows that the test plan is based on broad manufacturing philosophies and strategies, design topology, capabilities, limits, and idiosyncrasies of components, and correlations between parameters to be tested, as well as the test coverage further up the supply chain. When examined in detail, any product and test environment will reveal potential trade-offs in yield, measurement uncertainty, and throughput which supports an overall desired result. Certain factors in the test environment – such as infrastructure, approach to fixturing, whether or not multiple DUT testing is used, and sampling rigor – will also affect the test plan. There may have to be some iterative experimentation to gain enough information to make decisions in these areas.

4.2 *Bluetooth* manufacturing stages

There are five main stages that can form a comprehensive *Bluetooth* manufacturing test process. The starting point of testing will vary depending on the product and the stage of testing.

1. Turn on

This is the first main stage of the test and it supplies the power to check for current drain, integrity of output lines for connectivity, and any major circuitry faults.

2. Initialize

This stage involves the loading of the firmware for the *Bluetooth* chip control and setting the *Bluetooth* address and DUT features. This can be done through control software from the chipset vendor that can be automated into the manufacturing line. Verifying the protocol stack is not a manufacturing test objective but it must be loaded correctly for the device to operate correctly. Often in a high-volume manufacturing environment the *Bluetooth* address is rewritten at the end of the manufacturing tests so that it is unique to the device being tested.

3. Calibration

This is where crystal tuning will occur for the chip. The power calibration is also performed at this stage. These calibrations can be performed with an Agilent N4010A wireless connectivity test set combined with the chip control software. Some devices are required to be reset after calibration so that the settings are permanently stored in the devices memory. Other tests that are less commonly used at this stage are RSSI calibration and IQ modulator calibration.

4. Parametric

This part of manufacturing will be the main focus of any *Bluetooth* product testing. Verification of the device being tested is performed through any parametric measurement that is critical to establishing and maintaining a link, so that data can be transferred between devices. There are various different tests that can be chosen depending on what area of the devices operation needs to be verified.

5. Functional

Functionality testing can be performed to simulate and verify the correct operation of a *Bluetooth* device. Various functions can be tested such as audio and programmable IO ports.

4.3. Test plan factors

The general aim of a test plan in a high-volume manufacturing environment is to have a test that can test the weak points of the *Bluetooth* device in the fastest time possible. With the introduction of enhanced data rate (EDR), more complexity has been added to the *Bluetooth* chip. This added complexity reinforces the need for fast and efficient testing. The ideal test plan will be implemented in the shortest possible time and cover all aspects of the *Bluetooth* chip design so that the manufacturer will have full confidence that the device will function correctly.

4.4. Testing the product in a production chain

A *Bluetooth* device can be tested at various stages in production, from chip foundry to fully integrated device. If the manufacturer knows that a test will be conducted further up the supply chain, it will be able to avoid doing any complex testing on this area of the design. For example, at the basic IC level the chip maker will not be able to test the whole functionality of the device, so instead the test coverage should be concentrated on any flaws that would be shown at that level. As tests can be performed at different levels in the production of the device it would be advised to test the *Bluetooth* device when a new factor is introduced to the system such as crystal oscillators, capacitors, or any protocol software. All calibration tests must be performed regardless of what tests have been performed in previous stages as these are vital to the correct operation of the device.

As testing can occur at different stages of production, some tests are made redundant because of the stage of production or because of testing further up the production chain. Tests can also be made redundant if part of the chipset design guarantees its performance. It is in the manufacturers' interest to eliminate any redundant testing as it will reduce the manufacturing test time.

4.5. Researching the test plan

When using a chip from one of the main silicon vendors it is useful to look at the data sheet before constructing the test plan. The data sheet for the chipset can provide valuable information when it comes to testing the limits of the device in a manufacturing environment, as it can highlight the areas of weakness and strengths in a design. Before assembling the test plan, a comprehensive test should be conducted on a number of the *Bluetooth* devices to gain knowledge of the general trends that will affect the device during testing. A good place to start when conducting comprehensive testing is to use the test specification tests defined by the *Bluetooth* SIG these are shown below in Table 1.

Table 1. This table shows the setup for all tests that can be performed on the Agilent N4010A wireless connectivity test set in accordance with the *Bluetooth* test specification.

Test	Packets/bits	Channels/hopping	Power level	Packet type
EDR relative transmit power	1	L, M, H		2-DH1
EDR differential phase encoding	100	L, M, H		2-DH1
EDR CFSMA	4	L, M, H		2-DH5
EDR BER floor performance	8,000,000	L, M, H	-60	2-DH5
EDR max input level	1,600,000	L, M, H	-20	2-DH5
EDR sensitivity	1,600,000	L, M, H	-70	2-DH5
Output power	1	Hopping	-40	DH5
Power control	1	L, M, H	-40	DH1
Modulation characteristics	10	L, M, H	-40	DH5
ICFT	10	Hopping	-40	DH1
Carrier drift	10	Hopping	-40	DH135
Single slot sensitivity	1,600,000	L, M, H	-70	DH1
Multi slot sensitivity	1,600,000	L, M, H	-70	DH5
Max input power level	1,600,000	L, M, H	-20	DH1

Another way to test the device before creating a test plan is to use a test program such as the Agilent N4017A Graphical Measurement Application, Figure 3. Other tools can also be used to measure the characteristics of the *Bluetooth* device. These include the Agilent ESA Spectrum Analyzer and software tools such as the Agilent 89601A Vector Signal Analyzer.

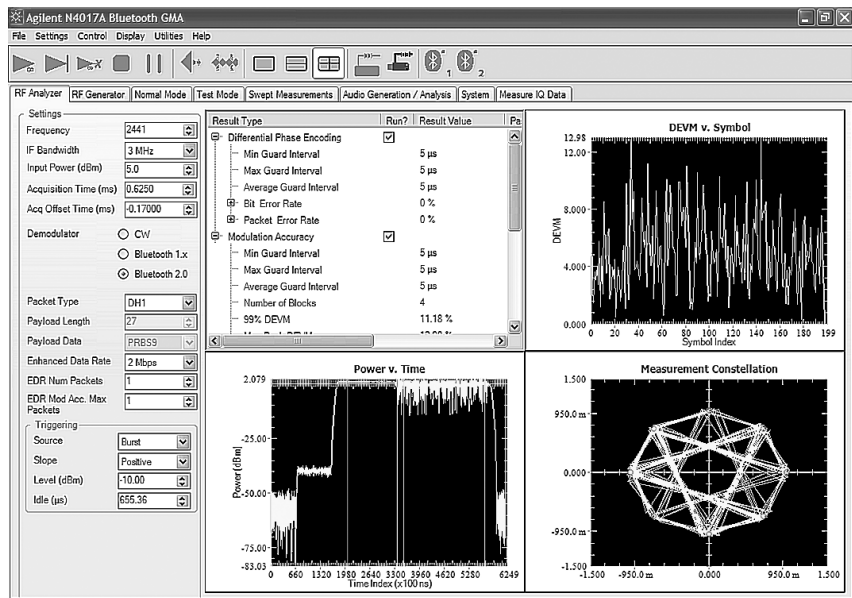

Figure 3. The Agilent N4017A GMA showing measurement of a *Bluetooth* EDR waveform.

Once the comprehensive testing has been completed the results can be analyzed to show where the main discrepancies between the devices occur. If all the devices tested show similar results, then the engineer will be able test the chip design's common strengths and weaknesses, and create an effective overall test plan for the design. The individual tests in the test plan can be chosen from the manufacturing test list in Section 4. This will help match the known weaknesses of the design with the appropriate tests for these areas.

5. Bluetooth Tests

As a *Bluetooth* device is made up of various parts, a sensible test strategy would be to target specific areas within the chip by choosing suitable tests. Detailed in this section is a list of all the test cases defined by the *Bluetooth* SIG in version 2.0+ EDR of the test specification. Each test is given a brief description of its function and the corresponding area of the *Bluetooth* device which is tested. This section should help you decide on the tests to use in the test plan by explaining in greater detail what each test achieves. A diagram of a *Bluetooth* device can be found in Appendix B.

5.1. Transmitter tests

TRM/CA/01/C – Output power

Tests a *Bluetooth* packet to find the highest and average power levels of the burst. This test is useful as it is very fast to execute and it provides important information about the transmitter power. It checks the operation of the power amplifier, which is an important part of the circuit that can affect link budget, battery life, and incidence of failure. It is tested with a hopping signal, so it also checks the hopping circuitry. The output power test can be replaced if power alignment is conducted before the main test sequence.

TRM/CA/02/C – Power density

Tests the power density in the frequency domain by taking 100 kHz bandwidth measurements. It tests the power amplifier as well as the modulator and the hopping circuitry. The power density test takes a long time to execute so it is not advised to include this in a test plan.

TRM/CA/03/C – Power control

This tests the calibration of the power control to ensure that the power levels and power control step sizes are within a specified range. If the device does not support power control, this test does not have to be implemented. This test can be useful in a device where battery life is maximized through dynamic level control as it tests the power amplifier control.

TRM/CA/04/C – Frequency range

The power density is tested at the highest and lowest bands of the *Bluetooth* spectrum to test the frequency range. The areas covered by the test are the hopping synthesizer and the crystal tuning of the device. This test can be substituted for the –20 dB bandwidth or the modulation index test as they all test for the same range of faults.

TRM/CA/05/C – –20 dB bandwidth

This tests the bandwidth of the device. It measures the –20 dB points on the output spectrum. For the waveform to pass, the –20 dB points must be less than 1 MHz apart for standard *Bluetooth*, or less than 1.5 MHz apart for EDR. This test is specified only for standard operation in the *Bluetooth* RF test specification, but it is also useful for testing an EDR waveform. This test is also useful for quality control of the modulator, although this may be covered adequately in chip testing.

TRM/CA/06/C – Adjacent power bandwidth

This test measures the power in the adjacent channels from the channel where the test transmission is taking place. The test checks the modulator for any out of band transmissions. It is useful for checking the design but the test takes a long time to execute. In a manufacturing environment, samples of the spectrum would be taken instead, to minimize the test time.

TRM/CA/07/C – Modulation characteristics

This test measures the frequency deviation of the signal. It is one of the most important tests to have in a manufacturing test plan as it tests for the waveform modulation quality. A low modulation quality may result in poor sensitivity. A high modulation quality will indicate a low spectral spread. The circuit areas this test addresses are the pre-modulation filter and the modulator performance. This test also checks the stability of the local oscillator circuitry.

TRM/CA/08/C – Initial carrier frequency tolerance

This verifies the accuracy of the transmitter carrier frequency. It also tests the transmit burst function and the synthesizer settling time. This test can be used to check the accuracy of the crystal oscillator in the circuit.

TRM/CA/09/C – Carrier frequency drift

This test checks and verifies the center frequency drift of a packet transmission. For analogue designs, this test is important since there can be a large variation in frequency drift. For digital systems using an IQ modulator, the design means the chip is not susceptible to carrier frequency drift. However, if there is voltage pull from external circuitry the carrier frequency could be affected.

5.2. EDR transmitter tests

TRM/CA/10/C – EDR relative transmit power

This test checks the difference in the power distribution between the two types of modulation schemes. The power control and amplifier circuitry is tested, as well as the switching between the different modulation types.

TRM/CA/11/C – EDR carrier frequency stability and modulation accuracy

This test checks that the modulation accuracy and frequency stability are within the required limits set by the test specification. This test is useful to test the overall modulation quality of the device. It is good for assessing the device as it neutralizes the effects from inter-symbol interference. This test can also be used to test the crystal oscillator accuracy.

TRM/CA/12/C – EDR differential phase encoding

This test assesses the modulator in the *Bluetooth* chip to ensure that it is encoding the data correctly. This test is useful as it checks a specific area of the chip design, however it is probably used more in design verification than in a manufacturing situation.

TRM/CA/13/C – EDR in-band spurious emission

Tests if the level of unwanted signal produced from the *Bluetooth* chip is below a limit set by the modulation scheme used. This tests the modulator and filters in the chip.

5.3. Receiver tests

RCV/CA/01/C – Single slot sensitivity

This test shows the minimum signal level needed to produce a maximum allowed Bit Error Rate (BER) level when sending a one-slot packet. This test can be limited by noise in the environment so test conditions must be taken into consideration when constructing a manufacturing test. This tests the receiver demodulator performance. Although the test specification defaults to "hopping off" for the sensitivity test, enabling hopping is often worthwhile in order to test the hopping circuitry for receiving a signal.

RCV/CA/02/C – Multi slot sensitivity

RCV/CA/02/C tests the minimum signal level needed to produce a maximum allowed BER level when sending a multiple-slot packet. The single and multi-slot sensitivity are very similar tests and only differ in the number of packets that are being sent. If there is not a significant difference in the results from the single and multi-packet tests, then only one of these tests should be chosen for a test plan. Multi-slot tests normally produce larger numbers of fail results so this should be used to assure better quality control.

RCV/CA/03/C – Carrier/Interference (C/I) performance

C/I performance measures the receivers BER after sending *Bluetooth* signals in parallel on the co-channel or the adjacent channel to the received signal. The areas tested are the filter and demodulator circuits. This is one of the most complicated tests to perform as it requires a number of different pieces of equipment. Due to the complexity of the test configuration this test is rarely used as a manufacturing test. The measurement is similar to the sensitivity measurements, which can be used instead of the C/I performance test.

RCV/CA/04/C – Blocking performance

This test measures the blocking performance of the receiver by sending a continuous interference wave. This measurement is again quite complex as it uses a similar setup to the C/I performance test. The receiver's blocking performance is guaranteed by the design of the radio, so this test is not recommended for a manufacturing environment.

RCV/CA/05/C – Intermodulation performance

This test measures unwanted frequency components resulting from interaction of two or more signals passing through a non-linear device. This characteristic is guaranteed by the design of the device so it is not recommended for a manufacturing test.

RCV/CA/06/C – Maximum input level

This test measures the receivers BER performance when the input signal is at a maximum power level. This test should not be included in the test plan if the device's basic function will never approach an overload problem during operation. This test is fast so if there are any maximum power issues this test should be included in the test plan.

5.4. EDR receiver tests

RCV/CA/07/C – EDR sensitivity

This measurement tests the minimum signal level required to produce a maximum value of BER. This can be limited by noise in the test environment so this must be taken into consideration when constructing a manufacturing test. It tests the performance of the filter and demodulator for an EDR signal.

RCV/CA/08/C – EDR BER floor performance

This test verifies that the receiver is below the BER maximum limit for normal test conditions. It is a good general test for the standard operation of an EDR device as it tests the receiver circuitry for general error conditions. This test could be removed if functionality testing is used as part of the manufacturing test process.

RCV/CA/09/C – EDR C/I performance

This test is similar to the standard C/I performance test. It tests how co- and adjacent channel interference affects the signal. This measurement is complicated as it requires multiple pieces of equipment for conducting the test. It also tests the same areas of the chip as the sensitivity tests. Due to these factors this test would not be recommended as part of a manufacturing test plan.

RCV/CA/10/C – EDR maximum input level

This test is similar to the standard version of this test. It measures the receivers BER performance when the input signal is at a maximum power level.

5.5. Other *Bluetooth* tests

Another test that is not specified by the *Bluetooth* SIG test specifications is the EDR guardband measurement. This is an important measurement as it checks that the guardband time is within the 4.75 to 5.25 μ s time period. The guardband allows time for the *Bluetooth* device to switch between the standard GFSK modulation scheme, to one of the EDR modulation schemes. It can be measured simultaneously with some of the EDR tests, which means that it should not take any additional time to measure.

5.6. Priority of *Bluetooth* tests

Table 2 shows a list of all 23 *Bluetooth* SIG qualification tests with a priority of high, medium, and low. The priority is a measure of the general need and usefulness of a test in a manufacturing environment. This list should be used as a guide in developing a test plan, while giving consideration to the larger explanation of each test, which is provided in Section 5. Appendix C contains further information on test equipment needed to perform each test.

Table 2. Test priority for manufacturing.

<i>Bluetooth</i> test	Priority
TRM/CA/01/C – Output power	High
TRM/CA/02/C – Power density	Low
TRM/CA/03/C – Power control	Medium/Low
TRM/CA/04/C – Frequency range	Low
TRM/CA/05/C – –20 dB bandwidth	Medium
TRM/CA/06/C – Adjacent power bandwidth	Medium/Low
TRM/CA/07/C – Modulation characteristics	High
TRM/CA/08/C – Initial carrier frequency tolerance	High
TRM/CA/09/C – Carrier frequency drift	High
TRM/CA/10/C – EDR relative transmit power	High
TRM/CA/11/C – EDR carrier frequency stability and modulation accuracy	High
TRM/CA/12/C – EDR differential phase encoding	Low
TRM/CA/13/C – EDR in-band spurious emission	Low
RCV/CA/01/C – Single slot sensitivity	High
RCV/CA/02/C – Multi slot sensitivity	High
RCV/CA/03/C – Carrier/Interference performance	Low
RCV/CA/04/C – Blocking performance	Low
RCV/CA/05/C – Intermodulation performance	Low
RCV/CA/06/C – Maximum input level	Medium
RCV/CA/07/C – EDR sensitivity	High
RCV/CA/08/C – EDR BER floor performance plan	High
RCV/CA/09/C – EDR C/I performance	Low
RCV/CA/10/C – EDR maximum input level	Medium

6. Creating the Test Plan

6.1. Combining *Bluetooth* standard and EDR tests

When testing a *Bluetooth* device it is wise to cover both the EDR and the standard *Bluetooth* 1.2 tests, as they are vital for testing different areas of the chip. None of the eight *Bluetooth* EDR tests test for hopping, so a standard *Bluetooth* test is needed to test this aspect of the *Bluetooth* device. When testing an EDR device, some of the tests in EDR and standard *Bluetooth* modes can overlap, which means that one test can be used to check all three of the modulation schemes specified in the *Bluetooth* 2.0 standard. In Section 5 there is an explanation of each of the *Bluetooth* SIG qualified tests. This can give a good indication as to which test to include in a manufacturing test plan, enabling you to make an educated choice on the tests you want to include in a manufacturing test plan.

6.2 Choosing test plans for *Bluetooth* 2.0 EDR devices

Test plans will vary depending on the design of the *Bluetooth* device. Shown below in Table 3 is an example manufacturing test plan for a *Bluetooth* 2.0 device. The aim of this test plan is to test all the main functional blocks of the *Bluetooth* chip, in the fastest time possible.

Table 3. An example of a *Bluetooth* EDR test plan

Test	Packets/bits	Channels/hopping	Power level	Packet type
EDR relative transmit power	1	L, M, H		2-DH1
EDR differential phase encoding				
EDR CFSMA	1	L		2-DH1
EDR BER floor performance	300,000	M	-60	2-DH1
EDR max input level				
EDR sensitivity				
Output power				
Power control				
Modulation characteristics				
ICFT	1	Hopping	-40	DH1
Carrier drift				
Single slot sensitivity				
Multi slot sensitivity	100,000	Hopping	-70	DH5
Max input power level				

When constructing the test plan, it is a good idea to start with the EDR tests. EDR is a more recent addition to the *Bluetooth* standard and it is likely that there will be less characterization data available for the EDR portions of the design. Selecting the EDR tests first will enable a broad range of testing to be accomplished, and any gaps in test coverage (for example, in testing the hopping circuitry) can be addressed by the inclusion of some *Bluetooth* 1.2 tests.

EDR relative transmit power tests the power amplifier and the effectiveness of switching between modulation schemes. This test is a key measurement for EDR, so should be included in most test plans.

EDR carrier frequency stability and modulation accuracy tests the modulator in addition to the crystal oscillator.

The hopping circuitry should also be tested, however, none of the EDR tests incorporate hopping. One of the four standard *Bluetooth* 1.2 transmitter tests should therefore be selected to test the hopping circuitry. These tests are output power, power density, ICFT, and carrier frequency drift. When deciding on which of these to use, it is important to understand what parts of the device are going to be the most susceptible to failure, refer to Section 5 for more information. Performing each of these tests could be useful although there is some overlap with the EDR tests so it is important to carefully select which tests to perform.

The receiver circuitry can be tested using either the EDR BER floor performance test or EDR sensitivity test. Although the RF test specification does not mandate that hopping is used for *Bluetooth* 1.2 or EDR receiver sensitivity tests, it is recommended that hopping is used in order to test the hopping circuitry in the receiver. In the example test plan, the *Bluetooth* 1.2 multi-slot sensitivity test was included, with hopping enabled, as the multi-slot test is more useful for quality control purposes, as described in Section 5.3. The EDR BER floor performance test was also included in the test plan as a general test of EDR receiver operation.

6.3. Choosing a test plan for Bluetooth 1.2 devices

The same principles apply in the pre-testing and calibration of a *Bluetooth* 1.2 device to those needed to test an EDR device, so the main change in testing will be in the test plan. When testing a standard *Bluetooth* 1.2 device that doesn't use the EDR capability there are 15 test cases to choose from.

Of the 15 possible test cases, there are six test cases that are classed as high priority. These six tests are shown below. All these tests can be performed by an Agilent N4010A Wireless Connectivity Test Set. Refer to Table 2 for more details about the pricing of the tests.

Table 4. An example of a non-EDR test plan

Test	Packets/bits	Channels/hopping	Power level	Packet type
Output power	1	Hopping	-40	DH1
Modulation characteristics	5	M	-40	DH1
ICFT	1	Hopping	-40	DH1
Carrier drift	5	M	-40	DH1
Single slot sensitivity				
Multi slot sensitivity	100,000	Hopping	-70	DH5

Table 4 is an example of a generic test plan for a standard *Bluetooth* device that does not use EDR. The test is designed to cover all of the major sections of a *Bluetooth* device in a very short time span, so it should only be taken as a starting point for a test plan. The variables of each test are important since each one can be tailored to suit an individual device plan. For further information about each test chosen please refer to Section 5.

6.4. Frequency hopping

All the modulation types used in *Bluetooth* 2.0 devices employ frequency hopping. The effect of the hopping is that the spectral density of the modulation scheme is widened. This has an obvious effect on some of the spectral measurement tests.

All EDR tests, and the majority of *Bluetooth* 1.2 tests, are conducted with frequency hopping switched off. This is done to ensure that specific parts of the chip are working correctly. It is therefore recommended that a test be conducted that has frequency hopping involved so that the RF synthesiser can be tested.

The hopping in a *Bluetooth* system is defined as a slow hop system, because the hopping rate is less than the symbol rate. This slow hopping enables the device to spread its spectrum across an 80 MHz range. This means that it is much more difficult for a signal to fail over the full range of the spectrum. When hopping is on, the power verses channel measurement, such as the one shown in Figure 4, gives a good indication as to which channel to test when constructing the test plan. The overall frequency response will almost always have some variation because certain frequency characteristics in the design will not be flat. For test purposes, the channels which have maximum and minimum variations would be a good choice for test channels.

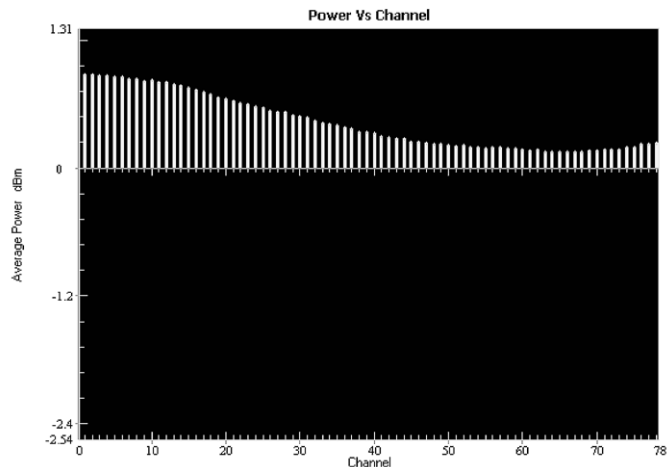

Figure 4. Agilent N4017A GMA showing a power verses channel graph.

6.5. Modulation types

With the *Bluetooth* 2.0 EDR standard, two new types of modulation scheme were introduced. These new modulation types, $\pi/4$ DQPSK and 8DPSK, are in addition to the standard GFSK modulation scheme. The addition of two new modulation schemes has increased the complexity of the chip design. Unlike GFSK modulation, $\pi/4$ DQPSK and 8DPSK do not have a constant transmission envelope, and therefore these schemes can exhibit the effects of non-linearity in the transmissions. The *Bluetooth* Special Interest Group has defined eight new tests in the 2.0 test specification to cover these new modulation schemes.

The type of modulation scheme used for EDR tests depends on the device being tested. The *Bluetooth* standard defines the 8DPSK modulation type as being an optional enhancement to the *Bluetooth* standard, so it would only be used in the test plan if the device being manufactured supported it. If both types of modulation are supported, then it would be recommended to use the 8DPSK modulation scheme since it has the highest data rate. Using 8DPSK you could conclude that if the test was successful, then the other modulation types would also work.

6.6. Test order

Once the tests for the test plan have been selected, the order that the tests are performed must be chosen. The ideal test plan would have the tests that are most likely to fail at the start of the test so that a faulty *Bluetooth* device can be removed from the production line, to avoid wasting time by conducting further tests.

Another consideration when defining the order of tests is that some tests use a common signal and can be measured simultaneously. For example, output power and modulation characteristics can be measured at the same time using an Agilent N4010A test set. Tests should be performed simultaneously whenever possible, as this can significantly reduce time in the manufacturing process.

6.7. Test parameters

Once the individual tests have been chosen, the test parameters must be selected. Test parameters are an important factor as they can cause test times to vary by a large degree. The main factor that affects test time is the number of bits or packets that are processed for the test. The *Bluetooth* qualification tests can have up to eight million bits processed for one test. Using this many bits is unrealistic for a manufacturing environment since the test would take too long.

For manufacturing test, the key is to find a balance between time for the test and the confidence that the test will produce valid results for that device. When planning the parameters it is important to look back at the research conducted on the device to know its weaknesses, so that if a section of the design is more likely to fail, more testing should be conducted on this part of the plan. If the number of bits is reduced for a test plan then the parameters for passing the test should also be changed so that the test gives an accurate result as possible. (Refer to Appendix C for information about test line limits (TLL).)

When deciding upon which packet type to use, each test in the plan has to be considered individually. The majority of tests will use a one-slot packet to ensure that the fastest possible transmission time is achieved.

When testing with hopping switched off the standard practice is to test the lowest middle and highest frequencies in the *Bluetooth* band. These are 2402, 2441, and 2480 MHz respectively. When constructing a manufacturing test plan, just one of these bands is normally chosen. The chosen band depends on which frequency is most likely to produce the greatest number of errors. It is general practice to test at the weakest point of a design, as this is most likely to show up any errors during the manufacturing process.

6.8. BER measurements

When testing the receiver circuitry the main measure of quality is the BER. The BER can be affected by many issues, from the design to the operating environment. When choosing parameters for the test plan it is important that the type of data being sent in the packet is known since the data can cause different levels of errors. Because of this it is wise to use the same data load that the *Bluetooth* test specification uses for its qualification tests.

BER is a statistical analysis of the transmission accuracy; the number of bits that is sampled greatly influences the result. This becomes a problem when planning manufacturing tests, making it difficult to find the balance between the time for test and the accuracy of the test result. Even in a well designed *Bluetooth* chip there will always be some random noise that causes a BER. As some of these errors will be random, it makes it difficult to scale down the number of bits that are tested without changing the BER pass level.

Some manufacturers may scale down the BER test parameters of the *Bluetooth* SIG using ratios to reduce the time for the measurement. This technique is the most basic of all BER reduction methods so there is an element of error associated with it. Other more complex statistical BER test time reduction may be used for a higher degree of accuracy. This technique works by using the formula shown below. This formula allows the test to have threshold pass rates so that if there are very few errors then the test will pass the device quickly or if the device is near the fail threshold it will be tested with a larger number of bits to ensure an accurate result. These limits can be written into a manufacturing program and can be measured using a test set such as the Agilent N4010A test set.

$$N = \frac{1}{BER} \left[-\ln(1 - CL) + \ln \left(\sum_{k=0}^E \frac{(N \times BER)^k}{k!} \right) \right]$$

The formula can be used to work out what BER level to set as a pass depending on how many bits are sent correctly. The formula can be solved empirically using a computer. E is the total number of error bits when working out error values. If there are no errors in the data, the second term equals zero, which greatly simplifies the equation. N is the number of bits that the system is transmitting. K is the range of error numbers which determines how many times the second part of the formula is calculated. The CL is the confidence level of the test given by a percentage as to how correct the test results are. The formula to calculate the confidence level is:

$$CL = \text{PROB} [BER_T < R] \text{ given } E \text{ and } N$$

This formula is the probability that the transmitted BER_T will be less than the BER limit, R. It is up to the manufacturer to choose the desired confidence level of the device during testing.

6.9. Functional testing

Functional testing is used to test a *Bluetooth* chip for a specific use, such as audio capabilities or data transfer. When deciding on functional testing, it is vital for the test engineer know what the main function of the device will be so that an appropriate test can be included in the test plan. Once the main function is known then a functional test can be constructed to simulate the device in operation. The tests can range from a simple data link connection to audio quality testing. Many simple functional tests are covered by the *Bluetooth* SIG test cases, so they do not have to be covered by additional functional testing. Setup information for data connection and audio functionality tests can be found in Appendix A.

7. Other Important Manufacturing Issues

After the test plan been selected a manufacturing engineer can then decide on the test equipment needed for the design of the whole test system. The majority of the *Bluetooth* calibration and manufacturing test can be carried out using an Agilent N4010A test set. Other tests may be chosen that require additional equipment such as spectrum analyzers and power meters. It is the test engineer's responsibility to design the system and choose the equipment that best fits the test need. (Refer to Appendix C for a full list of Agilent equipment for the *Bluetooth* qualification tests.)

If a device fails in production, a more comprehensive test plan performed outside of the production line should be used. This secondary test should be written to thoroughly exercise the device to find where the fault lies. Once the area of the fault has been detected, the manufacturer may choose to repair the device and return it to the start of the high volume test line.

Appendix A: Measurement Setup

Calibration tests

For details on the *Bluetooth* SIG tests covered in this application note, please refer to the Application Note 1331-1 *Bluetooth* Measurement Fundamentals. This appendix will describe measurement setup for common tests or calibrations that may be performed during manufacturing but are not detailed by the *Bluetooth* SIG.

There are a number of different calibration tests, of which many are vendor-specific. Detailed below is a method for calibrating two of the most generic parameters.

Crystal tuning

Crystal tuning is vital for the operation of the circuit since it sets the operating frequency of the device so that it is transmitting on the correct frequency. This can be performed using an N4010A test set. The N4010A is set to RF analyzer mode where it can measure the frequency offset and average power.

Power calibration

Power calibration is set up in much the same way as the crystal tuning using an N4010A test set in RF analyzer mode.

Functionality test setup

There are two main ways that data and audio connections can be made: through HCI loopback and using audio profiles. Audio connections are established in Synchronous Connection Orientated (SCO) state. Data and audio routing can be established using HCI loopback using a N4010A test set. When this mode is enabled, the audio quality of the *Bluetooth* device can be tested using an audio analyzer program. As illustrated in Figure 5, the test setup is similar to the standard *Bluetooth* test setup for test mode.

There are two HCI loopback modes in which an N4010A *Bluetooth* test set can operate. Local loopback sends back any data and command packets to the device without the host controller altering any data. This type of test can check the audio interfaces of the *Bluetooth* device. Remote loopback sends back all data that is transmitted and no analogue signal is recovered. The test is executed this way so that the signal can only be degraded by the DUT.

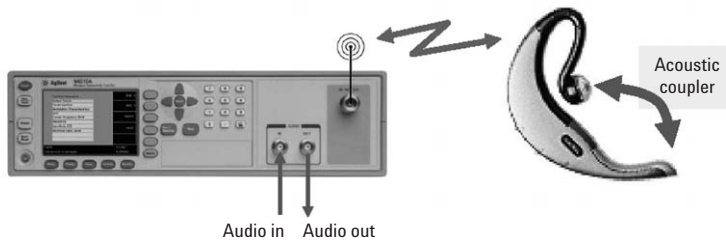

Figure 5. Setup for BT audio testing using HCI loopback.

Another way to test *Bluetooth* audio is by using a profile that describes the procedure a device must adhere to so that it can communicate with another device. A profile testing setup is shown in Figure 6.

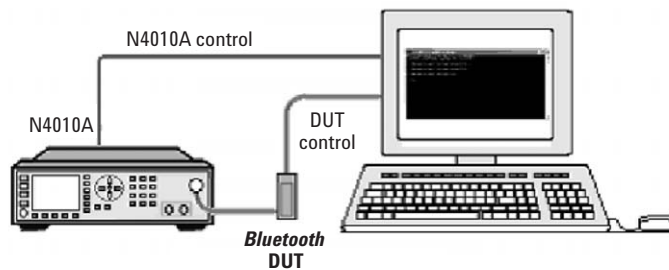

Figure 6. Setup for BT audio testing using audio profiles.

Appendix B: Bluetooth Radio Topology

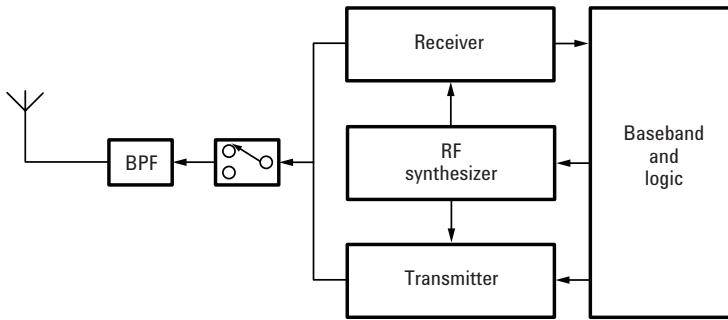

Figure 7. Block diagram of *Bluetooth* device.

This Appendix details the topography of the *Bluetooth* chip at a block diagram level as shown in Figure 7. The topology of a *Bluetooth* chip design refers to how a particular design accomplishes the requirements imposed upon it. The design topology dictates how the radio will respond under certain conditions. Different approaches to design can make the radio immune to some faults and susceptible to others. These design weaknesses will be used to form the basis of a test plan.

Some older *Bluetooth* radio designs use analogue techniques to implement the design. The analogue design uses phase lock loop technology, filters, and amplifiers to achieve a functional *Bluetooth* radio. The analogue design is not widely used for *Bluetooth* chips because of the uncertainty of parameters that can effect the operation of the device.

Modern *Bluetooth* chip are almost all digital designs. An example schematic is shown in Figure 8. The design has common frequency synthesis for transmitter and receiver circuits. The main change from the analogue design is that the signal is IQ-modulated.

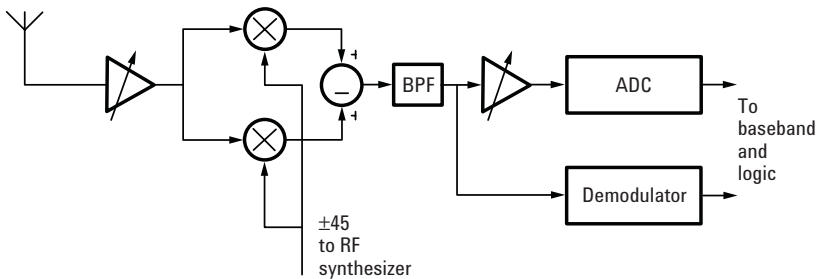

Figure 8. This diagram is an example of a *Bluetooth* radio receiver.

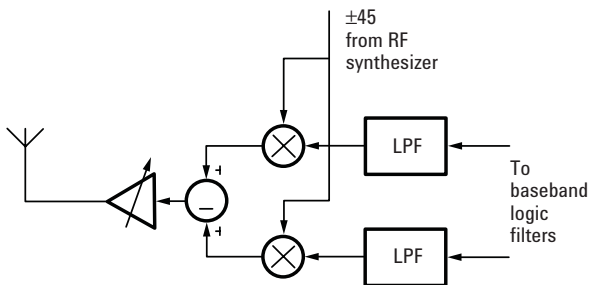

Figure 9. This diagram is an example of a *Bluetooth* radio transmitter.

Appendix C: Test Line Limit

Test result determination

Determining a test line limit (TLL), where a result from a test is compared against another number to trigger a pass or fail, would seem to be an easy task, but in fact it is rather complex. You should examine it from the outset of your test planning, since it will have a major effect on yields and may influence the equipment you select.

Yields

Bluetooth technology is used largely in low-cost, high-volume products, so manufacturing yields should remain high. What the exact number turns out to be will vary from product to product, and company to company, but it should normally be above 95 percent. Since we are seeking to maximize profit, the natural goal is to make this number very high – if it is high enough, it can eliminate the need for a repair process.

Yields are a function of design margin, process integrity (assembly, handling, and test), and component value integrity. While many of these have been discussed earlier, one topic which needs further exploration is the determination of test line limits in the test process. Figure 10 visualizes TLL.

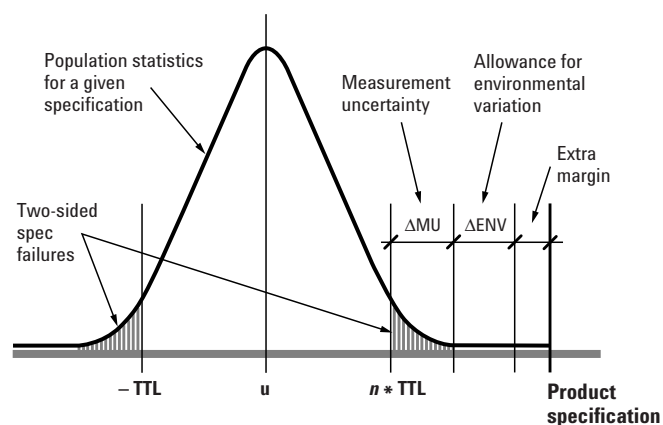

Figure 10. Specification (TLL) setting model.

The specification setting model

Figure 10 shows a two-sided test specification. In many cases, a one sided specification is appropriate – for example, in sensitivity measurements. The extra margin term is usually reduced to zero to allow as wide a TLL as possible. The $n * \Delta$ numbers represent choices made by the manufacturer to produce the desired yield. An n of two to six is often chosen; an n of two will lead to a 95 percent yield, an n of three should result in 99 percent yield. Clearly, the larger the n , the closer the yield will come to 100 percent, since the distribution curve is a composite of variations in product, components, processes, etc. Outright failures are not considered part of this characteristic; however, they are certainly part of the ultimate yield! The goal is to find and eliminate the causes of failures, and to ‘push’ the process to a tight normal distribution.

Establishing an initial distribution

The initial distribution should be determined by pilot runs and then refined over time as knowledge of the process increases. You should carefully monitor IC die and component lots, design changes, and other variables to ensure that older characteristics are not being incorporated into newer distributions.

Delta environmental (ΔEnv)

A thorough analysis would take a large sample of units and measure the yield against changes in the environment (ΔEnv). A wide range of approaches could be taken. If the 'primary use case' is indoors, the range of temperature and humidity will normally be small; if outdoors (e.g. a cell phone), it will be larger. Also, the results will have both mean and standard deviations. An aggressive approach might take only the means, while a conservative approach would include standard deviation (say, mean plus $2 \cdot \Delta$).

Measurement uncertainty (ΔMU)

Measurement uncertainty (ΔMU) can be a significant factor in selecting a TLL. If the uncertainty is too large, it will drive the TLL to be tighter than necessary, causing more failures. You should choose equipment and methodologies for the yields and margins needed in your individual application. For example, if you are measuring power output, a product with an uncertainty of 1 dB may result in unsatisfactory margins compared to one that has 0.2 dB uncertainty (e.g., a precision power meter). A practical example of this is power setting – it is usually best to set the power as low as possible (within the specification) to avoid excess battery consumption. In this case, the power meter's precision would have to be worked into the system and tested to reflect this change.

Appendix D: Agilent Solutions for *Bluetooth* Wireless Technology

Agilent equipment for *Bluetooth* testing

O = Meets fully-specified *Bluetooth* test requirements

A = Meets fully-specified *Bluetooth* test requirements when combined with other test equipment

X = Not fully compliant to *Bluetooth* test requirements; pre-compliance testing only

<i>Bluetooth</i> RF layer test cases	N4010A <i>Bluetooth</i> test set ⁵	N4017A <i>Bluetooth</i> GMA and N4010A ^{6,7}	ESA-E Series spectrum analyzers	86900 vector signal analyzer ²	P-Series or EPM-P Series power meters	E4438C ESG signal generator ¹
Transmitter tests						
Output power [TRM/CA/01/C]	0	0	0 ⁹	0	0	
Power density [TRM/CA/02/C]			0	0		
Power control [TRM/CA/03/C]	0	0	0 ⁹	0	0	
Tx output spectrum-frequency range [TRM/CA/04/C]			0	0		
Tx output spectrum –20 dB bandwidth [TRM/CA/05/C]			0 ⁹	0		
Tx output spectrum-adjacent channel power [TRM/CA/06/C]			0 ⁹	0		
Modulation characteristics [TRM/CA/07/C]	0	0	0 ⁹			
Initial carrier frequency tolerance [TRM/CA/08/C]	0	0	0 ⁹	0		
Carrier frequency drift [TRM/CA/09/C]	0	0	0 ⁹	0		
EDR						
EDR relative transmit power [TRM/CA/10/C]	0	0	0	0		
EDR carrier frequency stability and modulation accuracy [TRM/CA/11/C]	0	0				
EDR differential phase encoding [TRM/CA/12/C]	0	0				
Receiver tests						
Sensitivity/single-slot packets [RCV/CA/01/C]	0	0				X
Sensitivity/multi-slot packets [RCV/CA/02/C]	0	0				X
C/I performance [RCV/CA/03/C]	A ³	A ³				A ³
Blocking performance [RCV/CA/04/C]	A ⁴	A ⁴				A ⁴
Intermodulation performance [RCV/CA/05/C]	A ⁵	A ⁵				A ⁵
Maximum input level [RCV/CA/06/C]	0	0				0
EDR receiver test						
EDR sensitivity [RCV/CA/07/C]	0	0				
EDR BER floor performance [RCV/CA/08/C]	0	0				
EDR carrier-to-interference (C/I) performance [TP/RCV/CA/09/C]	A ⁸	A ⁸				
EDR maximum input level [RCV/CA/10/C]	0	0				
EDR transceiver test						
EDR in-band spurious emissions [TRM/CA/13/C]			0	0		

1. Used with Signal Studio for *Bluetooth* devices.

2. 89600 Series vector signal analysis software can be used with a variety of digitizers including: PSA and ESA-E spectrum analyzers, N4010A wireless connectivity test set, oscilloscopes, logic analyzers, and VXI.

3. The C/I performance receiver test requires an additional signal source with *Bluetooth* capability such as the N4010A or the ESG for the interfering signal.

4. The blocking performance receiver test requires a *Bluetooth* modulated source such as the N4010A or ESG and a microwave signal source such as the E8257D to generate the interfering signal (30 MHz to 12.75 GHz).

5. The intermodulation performance receiver test requires two *Bluetooth* modulated sources such as the N4010A or ESG and one CW source such as the ESG or the E8257D to generate intermodulation.

6. N4010A-101 required for *Bluetooth* 1.2 standard tests. N4010A-101 and -107 required for EDR tests.

7. N4017A-205 required for EDR test coverage.

8. The EDR C/I performance receiver test requires an additional signal source with *Bluetooth* EDR capability such as the N4010A Option 105 EDR Tx/Rx.

9. ESA *Bluetooth* Option 228 required.

Appendix E: References and Further Reading

The following documents are accessible via the Agilent *Bluetooth* Web site:
www.agilent.com/find/bluetooth

Application notes

Bluetooth Measurement Fundamentals, application note 1333-1,
literature number 5988-3760EN

Verifying Bluetooth Baseband Signals using Mixed Signal Oscilloscopes,
application note 1333-3, literature number 5988-2181EN

Agilent E4438C Signal Studio for Bluetooth, application note 1421,
literature number 5988-5417EN

Bluetooth EDR: The Wireless Evolution, application note, literature number 5989-4204EN

Product overviews

Agilent N4010A Wireless Connectivity Test Set, brochure, literature number 5989-4150EN

Agilent N4010A Wireless Connectivity Test Set, data sheet, literature number 5989-4035EN

Agilent N4010A Wireless Connectivity Test Set, configuration guide,
literature number 5989-3486EN

Agilent N4017A Graphical Measurement Application, product overview,
literature number 5989-2771EN

Agilent Innovative Solutions for Testing Bluetooth Enhanced Data rate Products,
product overview, literature number 5989-3055EN

Agilent Bluetooth Measurement Solution for the ESA-E Series Spectrum Analyzers,
product overview, literature number 5980-2786EN

Agilent ESA-E Series Spectrum Analyzer Bluetooth Measurement Option,
self-guided demonstration, product note, literature number 5980-2577EN

Agilent EPM-P Series Single- and Dual-Channel Power Meters, demonstration guide,
literature number 5988-1605EN

Agilent P-Series Power Meters and P-Series Wideband Power Sensors, technical guide,
literature number 5989-1049EN

Agilent Vector Signal Analysis Basics, application note 150-15,
literature number 5989-1121EN

Agilent Wireless Connectivity Testing, brochure, literature number 5988-4438EN

Generic RF recommended reading

Application notes

8 Hints for Making Better Measurements Using RF Signal Generators, application note 1306-1, literature number 5967-5661E

8 Hints for Making Better Spectrum Analyzer Measurements, application note 1286-1, literature number 5965-7009E

Cookbook for EMC Precompliance Measurements, application note 1290-1, literature number 5964-2151E

Measuring Bit Error Rate using the Agilent ESG-D Series RF Signal Generators Option UN7, application note, literature number 5966-4098E

Spectrum Analysis Basics, application note 150, literature number 5952-0292

Testing and Troubleshooting Digital RF Communications Receiver Designs, application note 1314, literature number 5968-3579E

Testing and Troubleshooting Digital RF Communications Transmitter Designs, application note 1313, literature number 5968-3578E

Fundamentals of RF and Power Measurement, parts 1 - 4, literature numbers 5988-9213EN, 5988-9214EN, 5988-9215EN, 5988-9216EN

Product notes

Agilent 89600 Series Wide Bandwidth Vector Signal Analyzers, literature number 5980-0723E

Agilent ESG Family of RF Signal Generators, configuration guide, literature number 5965-4973E

References

1. Bluetooth *Test Specification* – RF, Part A, for Specification 2.0, Revision 2.0, March 21, 2005 – Bluetooth SIG
2. *Specification of the Bluetooth System* – Version 2.0 + EDR, Volume 0, November 4, 2004 – Bluetooth SIG
3. The official *Bluetooth* Web site, **www.bluetooth.com**. Includes information on *Bluetooth* history, technology, news, specifications, applications, products, events, and *Bluetooth* Special Interest Group (SIG). The *Bluetooth* SIG-Members area Web site, **www.bluetooth.org** provides access to Bluetooth *Test Specification*, announcements and pre-release specifications. This Web site is password protected for some technical documents.
4. Explaining those BER test mysteries, *Lightwave Magazine*, Justin Read, September 2004

Bluetooth and the *Bluetooth* logos are registered trademarks owned by *Bluetooth* SIG, Inc., U.S.A. and licensed to Agilent Technologies, Inc.

Related Literature List

89600S Vector Signal Analyzer CD,
literature number 5980-1989E

*89600 Series Vector Signal Analysis
Software 89601A/89601AN/89601N12*,
Technical Overview,
literature number 5989-1679EN

*89600 Series Vector Signal Analysis
Software 89601A/89601AN/89601N12*,
Data Sheet, literature number 5989-1786EN

*Hardware Measurement Platforms for
the Agilent 89600 Series Vector Signal
Analysis Software*, Data Sheet,
literature number 5989-1753EN

*89650S Wideband Vector Signal Analyzer
System with High Performance Spectrum
Analysis*, Technical Overview,
literature number 5989-0871EN

*89650S Wideband Vector Signal Analyzer
System with High Performance Spectrum
Analysis*, Configuration Guide,
literature number 5989-1435EN

89607A WLAN Test Suite Software,
Technical Overview,
literature number 5988-9574EN

89604A Distortion Test Suite Software,
Technical Overview,
literature number 5988-7812EN

Related Web Resources

For more information, visit:
www.agilent.com/find/89600

Agilent Open

www.agilent.com/find/open

Agilent Open simplifies the process of connecting and programming test systems to help engineers design, validate and manufacture electronic products. Agilent offers open connectivity for a broad range of system-ready instruments, open industry software, PC-standard I/O and global support, which are combined to more easily integrate test system development.

Remove all doubt

Our repair and calibration services will get your equipment back to you, performing like new, when promised. You will get full value out of your Agilent equipment throughout its lifetime. Your equipment will be serviced by Agilent-trained technicians using the latest factory calibration procedures, automated repair diagnostics and genuine parts. You will always have the utmost confidence in your measurements.

Agilent offers a wide range of additional expert test and measurement services for your equipment, including initial start-up assistance onsite education and training, as well as design, system integration, and project management.

For more information on repair and calibration services, go to

www.agilent.com/find/removealldoubt



Agilent Email Updates

www.agilent.com/find/emailupdates

Get the latest information on the products and applications you select.



Agilent Direct

www.agilent.com/find/quick

Quickly choose and use your test equipment solutions with confidence.

www.agilent.com

For more information on Agilent Technologies' products, applications or services, please contact your local Agilent office. The complete list is available at:

www.agilent.com/find/contactus

Phone or Fax

United States:

(tel) 800 829 4444
(fax) 800 829 4433

Canada:

(tel) 877 894 4414
(fax) 800 746 4866

China:

(tel) 800 810 0189
(fax) 800 820 2816

Europe:

(tel) 31 20 547 2111

Japan:

(tel) (81) 426 56 7832
(fax) (81) 426 56 7840

Korea:

(tel) (080) 769 0800
(fax) (080) 769 0900

Latin America:

(tel) (305) 269 7500

Taiwan:

(tel) 0800 047 866
(fax) 0800 286 331

Other Asia Pacific Countries:

(tel) (65) 6375 8100
(fax) (65) 6755 0042
Email: tm_ap@agilent.com

Revised: 09/14/06

Product specifications and descriptions in this document subject to change without notice.

© Agilent Technologies, Inc. 2003 - 2006
Printed in USA, October 12, 2006
5988-5412EN



Agilent Technologies