

Keysight Technologies

Fundamentals of RF and Microwave Measurements (Part 4)

Application Note



An Overview of Keysight Instrumentation for RF/Microwave Power Measurements

For user convenience, the Keysight Technologies, Inc. *Fundamentals of RF and Microwave Power Measurements*, application note 64-1, literature number 5965-6330E, has been updated and segmented into four technical subject groupings. The following abstracts explain how the total field of power measurement fundamentals is now presented.

Fundamentals of RF and Microwave Power Measurements

Part 1: Introduction to Power, History, Definitions, International Standards, and Traceability, AN 1449-1, literature number 5988-9213EN

Part 1 introduces the historical basis for power measurements, and provides definitions for average, peak, and complex modulations. This application note overviews various sensor technologies needed for the diversity of test signals. It describes the hierarchy of international power traceability, yielding comparison to national standards at worldwide National Measurement Institutes (NMIs) like the U.S. National Institute of Standards and Technology. Finally, the theory and practice of power sensor comparison procedures are examined with regard to transferring calibration factors and uncertainties. A glossary is included which serves all four parts.

Part 2: Power Sensors and Instrumentation, AN 1449-2, literature number 5988-9214EN

Part 2 presents all the viable sensor technologies required to exploit the users' wide range of unknown modulations and signals under test. It explains the sensor technologies, and how they came to be to meet certain measurement needs. Sensor choices range from the venerable thermistor to the innovative thermocouple to more recent improvements in diode sensors. In particular, clever variations of diode combinations are presented, which achieve ultra-wide dynamic range and square-law detection for complex modulations. New instrumentation technologies, which are underpinned with powerful computational processors, achieve new data performance.

Part 3: Power Measurement Uncertainty per International Guides AN 1449-3, literature number 5988-9215EN

Part 3 discusses the all-important theory and practice of expressing measurement uncertainty, mismatch considerations, signal flowgraphs, ISO 17025, and examples of typical calculations. Considerable detail is shown on the ISO 17025, *Guide for the Expression of Measurement Uncertainties*, has become the international standard for determining operating specifications. Keysight Technologies, Inc. has transitioned from ANSI/NCSL Z540-1-1994 to ISO 17025.

Part 4: An Overview of Keysight Instrumentation for RF/Microwave Power Measurements, AN 1449-4, literature number 5988-9216EN

Part 4 overviews various instrumentation for measuring RF and microwave power, including spectrum analyzers, microwave receivers, network analyzers, and the most accurate method, power sensors/meters. It begins with the unknown signal, of arbitrary modulation format, and draws application-oriented comparisons for selection of the best instrumentation technology and products.

Most of the note is devoted to the most accurate method, power meters and sensors. It includes comprehensive selection guides, frequency coverages, contrasting accuracy and dynamic performance to pulsed and complex digital modulations. These are especially crucial now with the advances in wireless communications formats and their statistical measurement needs.

Introduction

The purpose of the new series of *Fundamentals of RF and Microwave Power Measurements* application notes, which were leveraged from former note 64-1, is

- 1) Retain tutorial information about historical and fundamental considerations of RF/microwave power measurements and technology which tend to remain timeless.
- 2) Provide current information on new meter and sensor technology.
- 3) Present the latest modern power measurement techniques and test equipment that represents the current state-of-the-art.

Fundamentals Part 4, Chapter 2 presents an overview of various instrumentation for measuring RF and microwave power. Those methods include spectrum analyzers, microwave receivers, vector signal analyzers, and wireless and cellular test sets, among others. Naturally, it also includes the most accurate method, power sensors and meters. It begins with the unknown signal of arbitrary modulation format and draws application-oriented comparisons for selection of the best instrumentation and technology.

Chapter 3 reviews other applications and measurement considerations of power sensors and meters not covered in the technology presentations of *Fundamentals Part 2*. These include such matters as susceptibility to overload, automated data functionality, etc.

Chapter 4 provides an overview of the entire line of Keysight sensors and meters. It includes a functionality chart for compatibility of sensors with meters. Some early sensor technologies like thermocouples work with all Keysight meters, while new peak and average sensors are only compatible with the EPM-P meter. Signal application charts and frequency and power range capabilities are all presented in tabular format.

Note: In this application note, numerous technical references will be made to the other published parts of the series. For brevity, we will use the format *Fundamentals Part X*. This should insure that you can quickly locate the concept in the other publication. Brief abstracts for the four-part series are provided on the inside front cover.

A Review of Various Power Measuring Instrumentation

Instrument alternatives for measuring RF/microwave power

Ingenuity has dominated the inventive progress of RF/microwave power measurements. One clever method mentioned in *Fundamentals Part 1*, was the World War II (WWII) legend of Russell Varian drilling a tiny hole in his experimental klystron cavity and using a fluorescent screen to indicate whether the oscillation was on or off. Other non-instrument methods followed, such as the "water-load" calorimeter, which threaded a glass tube diagonally through a rectangular waveguide. By measuring the heat rise and flow rate of the water stream, the transmitter power could be computed. That method served both as a high-power termination for the tube as well as a power measuring process.

Serious power measuring instrumentation came out of the WWII developments of radar, countermeasures and communications system demands. Crystal detectors furnished a crude method of indicating and metering power, but since they were fragile, the high power signals required precision attenuation before applying to the sensor. Bolometers, which utilized tiny power-absorbing elements, terminated the unknown power and heated up. By monitoring or sensing the heat buildup, highly accurate measurements could be realized on unknown power over wide frequency ranges.

Microwave superheterodyne-type receivers were always capable of sensing RF/microwave power because their inherent purpose was the detection and display of power versus frequency. Some called them "frequency-domain oscilloscopes." While most such receivers were used for system purposes, some were used for research and instrumentation. The main advantage of using superheterodyne-type instruments was and is the ability to obtain power over a specified and tuned bandwidth, whereas power sensors measure total power across their entire specified frequency range.

Early spectrum analyzers were basically uncalibrated for absolute power. An unknown signal under test could be measured by comparison with a known power from a calibrated signal generator, where the microwave receiver was used only as a comparison sensor. The calibrated reference signal generator signal would be adjusted to be equal to the unknown.

Types of superheterodyne instruments for measuring power

In 1964, Hewlett-Packard introduced the HP 851/8551 as the first “power-calibrated” spectrum analyzer, available as a commercial product. This offered a considerable advance in frequency and power characterization of unknown signals. While we look back now at such relatively crude instruments with relatively poor accuracy specifications, they were the wonders of their time.

Enormous progress has been made in improved accuracy and functionality in the intervening years. Spectrum analyzers have gained digital precision in both frequency and power level because of sophisticated digital signal processing (DSP) microcircuitry and more precise components such as highly-linear amplifiers. Meantime, a number of other types of instrumentation have also been configured to make excellent measurements of power levels, not just for simple modulated signals, but for all of the new modulation formats common to the modern communications and wireless systems.

Here is a list of typical instrument types, based on a superheterodyne block diagram, that are designed to make signal power measurements:

- spectrum analyzers
- vector signal analyzers
- calibrated microwave test receivers
- other instruments

Another variety of instrumentation for signal power measurements is the popular and ubiquitous wireless, cellular, and communications test sets. For the purposes of this application note, a test set is considered to contain an array of test functions that can characterize a complete operating communications system, both transmitter and receiver. It provides precision calibrated and adjustable test signals with system-specific modulation formats to test the system’s receiver portion, and it contains power measurement capability to characterize the performance of the system’s transmitter.

A typical wireless test set would be the Keysight E5515C mainframe and E1962B test application software. For the most precise power measurement, such a test set uses directional bridges at its input to feed the power to a thermal power detector as well as a “fast power detector.” Other portions of the test set feature demodulation downconversion and measurement downconversion, which utilize the superheterodyne processes.

Power measurement considerations for superheterodyne instruments [1]

As with most things in life, a required measurement of a system's output power comes with predictable tradeoffs. Simply stated, the power sensor/power meter method always offers the best measurement accuracy, but it measures all the power at the input to the sensor - it is not frequency-selective. Further, the power meter method measures true average power, even of complex digital modulation formats, some of which look like noise. Even peak power sensors, which are based on detection curves ranging from square law to linear, are digitally compensated to present full averaging of power. Power meter instrumentation now also provide time-selective measurements, meaning the user can set time gates for bracketing the time period over which a power measurement is made.

Superheterodyne-type instruments, on the other hand, offer versatile frequency selectivity, as well as considerable flexibility on the measurement of signal power, also including all the newer and complex modulation formats. In fact, one of the main reasons that superheterodyne-type instruments are selected is to provide a selectable bandwidth for a power measurement. A typical requirement would be for measuring integrated channel power in the presence of other system channel power.

Since their block diagrams are typically double or triple downconversion, there are important measurement considerations of resolution bandwidth, types of final detection and, more-importantly, the particular DSP algorithms used to furnish output data for the power level. [2]

Figure 2-1 shows a block diagram of a typical modern spectrum analyzer. The unknown signal receives a user-set attenuation, usually has some pre-selection filtering, then gets downconverted to an IF (intermediate frequency) amplifier. Modern analyzers are designed with less and less IF amplification and more and more powerful DSP microcircuits further forward in the IF signal path. Those DSPs can now sample the IF signals and their modulation envelope with extremely high sampling rates.

Whatever signal conditioning strategy is used, the end result is a display presentation of the modulation envelope of the signal under test. It should be noted that this is all carried out as linear detection, meaning the display is a voltage-related parameter. Logarithmic amplifiers or logarithmic data processing, as shown in Figure 2-1, converts the display to a dB display at the user command. Such display formats are especially useful for ultra-wide dynamic amplitude ranges, for example 10 dB per division.

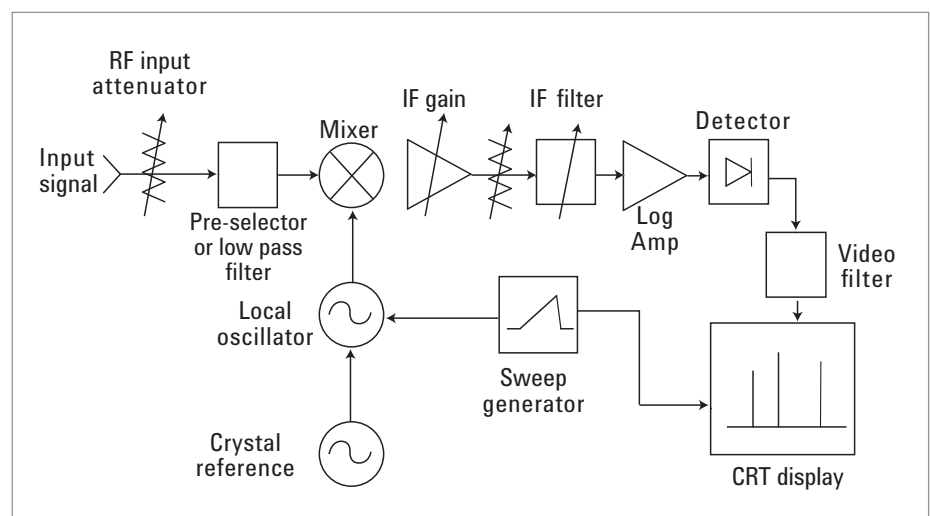

Figure 2-1. Block diagram of a typical traditional superheterodyne spectrum analyzer.

To measure power, consider the CW power spectrum of Figure 2-2(a). The display is produced by sweeping frequency (horizontal scale) across the CW unknown power. If the resolution bandwidth (RBW) set by the user is wider than the spectral components of the unknown CW, then the highest point on the display will represent the true CW power.

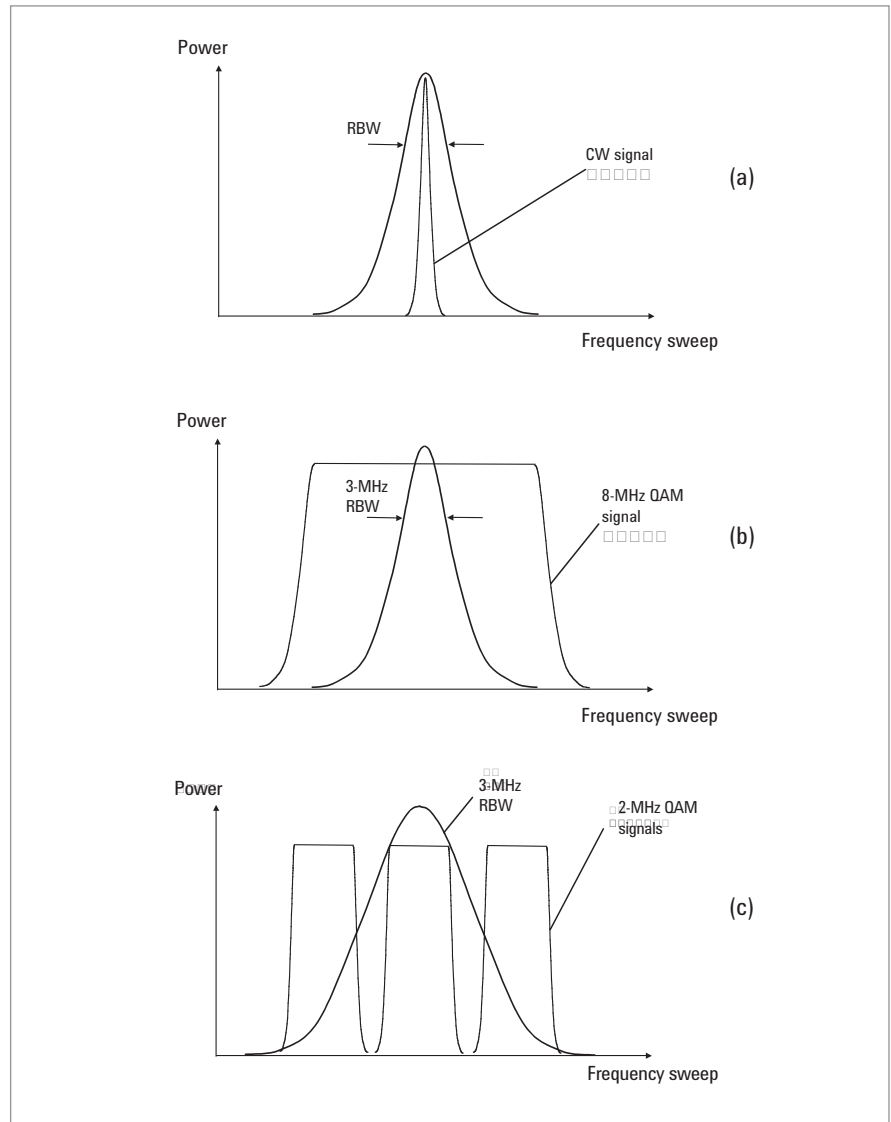

Figure 2-2. A spectrum analyzer's resolution bandwidth setting can be adequate for a single CW power measurement (a), but for digitally modulated signals it is either inadequate (b) or erroneously adds power in from the adjacent channel (c).

Now, consider an unknown signal as in Figure 2-2(b), which is a QAM (quadrature-amplitude-modulation) format with an 8 MHz bandwidth. This is considerably wider than the filter's RBW of 3 MHz, and therefore cannot integrate all the 8 MHz power.

If you select a RBW setting that is larger than the unknown signal, will that integrate the unknown broadband signal format? Well, no, because the RBW filter is Gaussian shape, and while it may be wide enough to enclose the unknown signal at its -3 dB points, out at the noise floor of the RBW, its width will enclose a lot of noise as well as perhaps other adjacent channels of power. This is shown in Figure 2-2(c) as a QAM signal of 2 MHz bandwidth, easily enclosed by the 3 MHz RBW of the analyzer, but also allowing in unwanted sideband channels and noise.

The upshot of this analysis is that the measurement needs to be made with a narrower RBW, such that the skirts of its filter are steep and help define the skirts of the power spectrum of the unknown signal under test. Powerful software computation routines of modern analyzers take all this into consideration, realizing that the user simply wants to measure the integrated “channel power” of a wireless channel, for example 8 MHz, and reject the channel power of the adjacent channel which is also on the air.

The analyzer performs this task internally by using the proper RBW settings, and making corrections for what is called the equivalent noise power bandwidth (ENPBW) using a correction factor for Keysight ESA analyzers of 1.128. The internal computations for pre-set channels can also be pre-determined since the performance parameters for industry standard wireless formats are known, for example CDMA, TDMA, etc. Suffice to say that instrumentation analyzers based on the superheterodyne principle have powerful characterization capabilities, and generally can provide channel power readings with accuracies on the order of ± 1 dB or less.

When considering the tradeoffs in specifying power instrumentation, a lot will depend on the needs of the measurement requirement and the condition of the unknown signal. Is it accompanied by multiple channels? Is the lowest uncertainty required? Does the unknown signal format contain time-domain characteristics that need to be time-selectively sorted out by the Keysight EPM-P and P-Series gated power capabilities?

Power measurement considerations for test-set-type instruments

A modern wireless test set provides two paths for measuring unknown power. The first was mentioned above, whereby the unknown signal is directionally-bridged off right at the input terminal and applied to either a thermal detector or a peak detector. This assures that the best possible accuracy is maintained for characterizing the unknown. Actual performance specifications are quoted in considerable detail for various frequency bands and power levels. For a general ballpark figure, specified uncertainties range from ± 4.2 percent to ± 7.5 percent (typical ± 3.0 percent). Such specifications, of course, state only the instrument performance, other uncertainties such as mismatch and power reference details would have to be computed for given measurement environments and requirements. Specifications differ for the thermal detector and the peak detector.

The other power measurement function of test sets is the “tuned channel power measurement.” This is the one that utilizes the complete superheterodyne downconversion signal chain, such that it measures and computes “channel power,” by rejecting adjacent channel power in operating systems. Typical measurement uncertainty for such system signal characterization is stated in the ± 1 dB ranges. Calibrating against a known power level signal furnished from within the test set enhances accuracy for this function. Again, additional uncertainties would need to be considered for mismatch and other additives.

[1] Mill, Alistair, Measuring Digital Carrier Power with a Spectrum Analyzer, Test & Measurement World Europe, April/May 2000.

[2] Keysight, Spectrum Analyzer Basics, Keysight Application Note 150, literature number 5952-0292.

Power Sensor/Meter Methods and Comparisons

Assume that the user's power measurement requirements have been analyzed. The outcome of that analysis shows that power sensor/meter is the preferred method. All of the previous discussion in *Fundamentals Part 2* on sensor and meter technology still leaves choices for which power meter and sensor will provide the best or fastest or most accurate solution. As was seen, each average or peak and average sensor and meter technology has some advantages over the others, yet there is an optimum choice, and that is the purpose for this chapter.

Factors such as cost, frequency range, the range of power levels to be measured, the importance of processing and capturing data, accuracy, speed of measurement, and the skill of the personnel involved take on varying degrees of importance in different situations. This chapter compares the measurement systems from several aspects to aid in the decision-making process for any application. At the end, a signal applications chart profiles sensors best suited for particular modulation formats. Other charts briefly overview the measurement capabilities of the sensor and power meter families now available from Keysight.

Accuracy vs. power level

This comparison of power measuring systems demonstrates the measurement uncertainty and power range of several equipment selections. The EPM Series power meters and E Series sensors are emphasized, although several existing sensors are included. The EPM-P meters and E9320A peak and average sensors were not included in this comparison exercise since they require other considerations outlined in *Fundamentals Part 2*, Chapter V.

Figure 3-1 shows plots of the root-sum-of-squares (RSS) uncertainty when measuring power for a common condition at various levels from -70 to $+20$ dBm. The measurement conditions were assumed for a CW signal at 2 GHz and a source SWR of 1.15, and data sheet specifications.

The three parts of this figure show a comparison of three common combinations of power meter and sensor:

- a) Keysight 432A analog power meter plus 8478B thermistor sensor.
- b) Keysight E4418B digital power meter plus 8481A thermocouple and 8484D diode sensor.
- c) Keysight E4418B digital power meter plus E4412A extended dynamic range power sensor.

The data for Figure 3-1 was computed using a commercially-available mathematics simulation software product called MathCad. To present these operating performances under typical present-day conditions, the ISO uncertainty combining process of *Fundamentals Part 3* was used for the MathCad calculations. Results are approximate, although they are entirely suitable for these comparison purposes.

The reason for presenting these overall measurement uncertainties in this format is that, as far as the user is concerned, there is little need to know whether the sensor works on the diode principle or on the thermocouple principle. With the introduction of the new extended-range PDB diode sensors, a single E4412A sensor can achieve the -70 to $+20$ dBm power range, which previously required a combination of diode and thermocouple sensors.

The top graph of Figure 3-1 describes the thermistor sensor/meter combination and is shown mostly for reference. With the decreasing applications of thermistor-type sensors, the primary need for understanding their theory and practice is that they are used as power transfer devices for metrology round robins. They also find use in transferring a power reference from a higher-accuracy echelon or national standards labs to operating labs. In the DC substitution process, 432 instrumentation error is substantially reduced because the substitution DC power can be measured with precision digital voltmeters.

A comparison of the top two graphs of Figure 3-1, (a) and (b), shows that the uncertainties of the thermocouple and diode-based systems (b) are somewhat less than the thermistor-based systems (a). At this 2 GHz calculation frequency, the thermocouple and diode sensors have the better SWR (see Figure 3-2), but the thermistor system, being a DC substitution system, does not require a power reference oscillator and its small added uncertainty. These two effects tend to offset each other for this application. The significant advantage of the E4418B power meter measurement is the performance flexibility of being able to use the large installed base of all the other Keysight family of thermocouple and diode sensors.

The third graph of Figure 3-1, (c), for the E4418B power meter and E4412A extended dynamic range sensor, immediately shows that even with the sensor's wide dynamic measurement range from -70 to +20 dBm, it provides approximately equivalent uncertainties. The dashed portion of the E Series sensor curve (0 to +20 dBm) represents nominal high-power cal factor uncertainty limitations imposed by the sensor calibration system. Refer to the latest sensor technical specifications to determine actual uncertainties for your particular application.

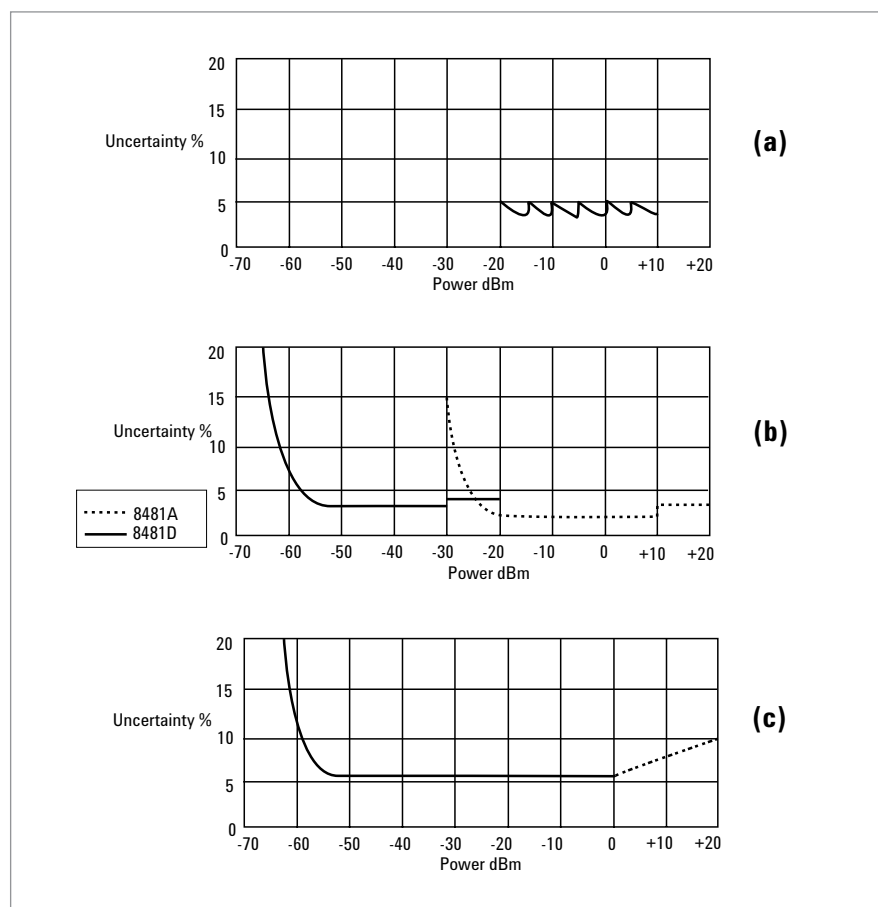

Figure 3-1. RSS uncertainty vs. dynamic power range from data sheet specs for source SWR = 1.15 ($\rho_s = 0.07$) and $f = 2$ GHz: (a) Analog thermistor mount system(432A plus 8478B). (b) E4418B digital power meter system using 8481D diode and 8481A thermocouple sensors. (c) E4418B digital power meter and E4412A PDB extended-range sensor. RSS-combining method is the same as used in *Fundamentals Part 3*.

While most modern power meter designs have utilized digital architectures, analog-based meters, such as the 432A, are still available. Analog meter measurements are limited by the mechanical meter movement of the instrument that requires uncertainty to be stated in percent of full scale. Thus, at the low end of each range, the uncertainty becomes quite large when expressed as a percent of the reading. Digital systems are free of those problems and, with proper design and an adequate digital display resolution, provide better accuracy.

The instrumentation accuracy for a digital meter is specified as a percent of the reading instead of as a percent of full scale. This means that at the point of each range change, there is not a big change in uncertainty for the digital meter. This effect can be seen in the max-min excursions of the sawtooth-like curves of the analog meter shown in Figure 3-1 (a). For this reason, the digital power meter does not need as many ranges; each digital range covers 10 dB with little change in accuracy across the range.

One application advantage attributed to analog meters is the “tweaking” functions where an operator must adjust some test component for optimum or maximum power. Digital displays are notoriously difficult to interpret for “maximizing or minimizing” readings, so the display of the E4418B power meter features an analog scale in graphic display format, which provides for the “virtual-peaking” function.

It should be recognized that the accuracy calculations of Figure 3-1 are based on specification values. Such specifications are strongly dependent on the manufacturers’ strategy for setting up their specification budget process. Some published specifications are conservative, some are less so. Manufacturers need to have a good production yield of products for the whole family of specifications, so this often leads to a policy of writing specifications that have generous “guard bands” and thus are more conservative.

Further, a particular measurement configuration is likely to be close to one specification limit, but easily meet another specification; a second system might reverse the roles. By using the new ISO uncertainty-combining method, this takes advantage of the random relationship among specifications and the uncertainties tend to be smaller, yet realistic.

A second reason to observe is that the Figure 3-1 calculations are done for one particular frequency (2 GHz) and one particular source SWR (1.15). A different frequency and different source match would give a different overall uncertainty. Sources frequently have larger reflection coefficient values that would raise the overall uncertainty due to usually-dominant mismatch effects.

Frequency range and SWR (reflection coefficient)

All three types of power sensors have models that cover a frequency range from 10 MHz to 18 GHz, some higher, with coaxial inputs. A special version of the thermistor mount operates down to 1 MHz (see *Fundamentals Part 2*) and the 8482A/B/H thermocouple power sensors operate down to 100 kHz. The effective efficiency at each frequency is correctable with the Calibration Factor dial or keyboard of the power meter, so that parameter is not particularly critical in deciding on a measurement system.

In most analyses, the sensor's SWR performance is most important because mismatch uncertainty usually contributes the largest source of error, as described in *Fundamentals Part 3*. Figure 3-2 shows a comparison of the specification limits for the SWR of a thermistor mount, a thermocouple power sensor, an 8481D PDB diode power sensor, as well as the E Series power sensors.

It should be recognized that published SWR specifications are usually conservative and that actual performance is often substantially better, yielding lower uncertainty in practice. That fact argues for a preferred practice that measures actual source SWR for situations where highest accuracy is important.

These graphs indicate that over the bulk of the frequency range, the thermocouple and diode sensors have a considerably-lower SWR than the thermistor sensor. It also shows that the E4412A sensor, even with its superior dynamic range, still provides a satisfactory SWR.

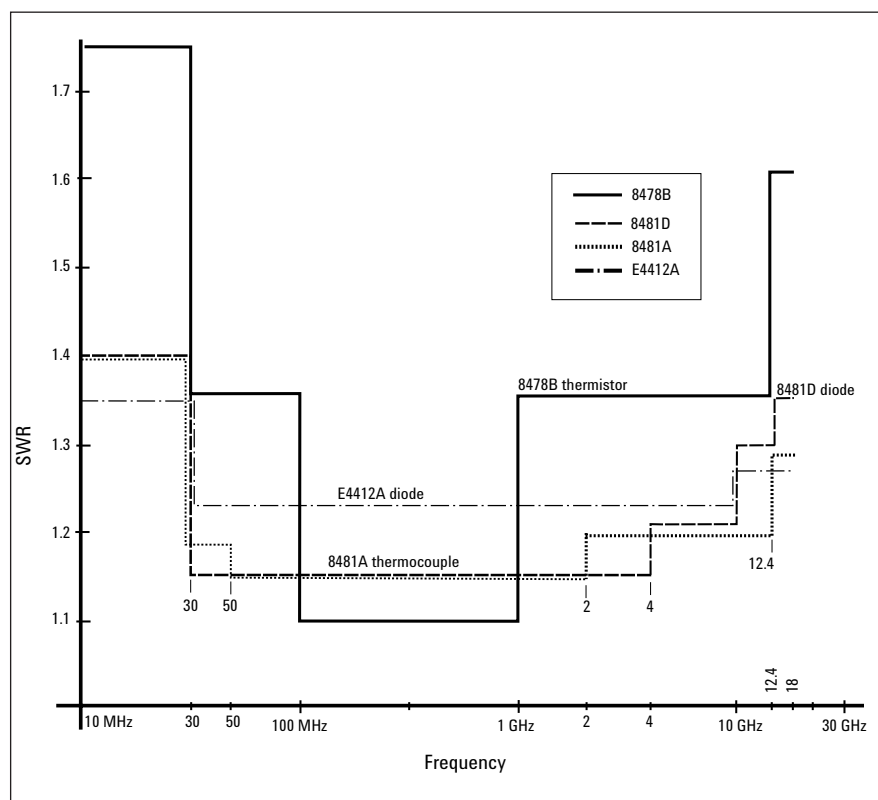

Figure 3-2. A comparison of specified SWR limits for the 8478B thermistor mount, 8481A thermocouple power sensor, 8481D PDB power sensor, and E4412A PDB sensor.

Waveguide sensor calibration

Power measurements in waveguide present several special considerations. Waveguide thermocouple and diode sensors must have the usual 50 MHz reference oscillator to adjust for calibration factor from one sensor to another. Such a low-frequency signal cannot propagate in a waveguide mode. Keysight waveguide thermocouple sensors (26.5 to 50.0 GHz) and waveguide diode sensors (26.5 to 110 GHz) all utilize a special 50 MHz coaxial injection port that applies the reference oscillator output to the sensor element in parallel to the usual waveguide input. This permits the meter-sensor system to be calibrated at their waveguide operating frequencies.

Speed of response at low signal levels

To measure the lowest power ranges with optimum accuracy, power meters are designed with a highly-filtered, narrow bandwidth compared to most other electronic circuits. Narrow band circuits are necessary to pass the desired power-indicating signal but reject the noise that would obscure the very weak signal. Narrow bandwidth leads to the long response time. For heat responding power sensors, like the thermistor and thermocouple, response time is also limited by the heating and cooling time constants of the heat sensing element.

The typical thermistor power measurement has a 35 ms time constant and 0 to 99 percent response time of about five time constants or 0.175 s. The power meters for thermocouple and PDB sensors have 0 to 99 percent response times of 0.1 to 10 s, depending on the range of the power meter. The more sensitive ranges require more averaging and hence longer settling times.

For manual measurements, the speed of response is seldom a problem. By the time the observer turns on the RF power and is ready to take data, the power meter has almost always reached a steady reading.

For analog systems applications, where rapid data acquisition is required, or where the power meter output is being used to control other instruments, the power meter acts like a low pass filter. The equivalent cutoff frequency of the filter has a period roughly the same as the 0 to 99 percent response time. For signals where the signal power changes too rapidly for the power meter to respond, the power meter averages the changing power. When a power meter is being used to level the output of a signal generator whose frequency is being swept, the speed of the frequency sweep may have to be reduced to allow the power meter time to respond to the power level changes.

There is no clear-cut advantage with regard to speed of one power measurement system over another. In some power ranges one system is faster, and in other ranges another system is faster. If response time is critical, manufacturers' data sheets should be compared for the particular application.

Automated power measurement

Recognizing that a large percentage of digital power meters are used in production test and in automated systems, it is reasonable to assume that digitizing measurement speed is critical in at least some of those applications. Digital power meters programmed for automatic operation gather data rapidly and with minimum errors. The data can be processed and analyzed according to programmed instructions, and the system can be operated with little process attention. Even in a manual mode, digital indications are less prone to the human error of misinterpreting the meter scale and using wrong range multipliers. In the case of power measurement, there are additional advantages to automatic systems. Successive data points can be compared mathematically to assure that the power measurement has reached steady state and multiple successive readings can be averaged to statistically reduce the effects of noise.

The Keysight EPM Series power meters have been optimized for maximum digitizing speed. Since its architecture is totally DSP-based, and it is married to a new E Series diode sensors, circuit decisions were made to increase the digitizing speed to maximum. For example, output filtering on the sensor is smaller, which provides faster response. On the lower power ranges, this smaller filtering might cause an increase in measurement noise, but the power meter itself provides for digital averaging up to 1,024 readings to minimize noise effects. The meter is specified to provide up to 20 readings per second and 40 per second in the X2 mode. The specification for the FAST range in the free-run trigger mode, using the binary output format, is 200 readings per second. For that function, circuit settling times are 5 mS for the top 70 dB power ranges.

Keysight's EPM-P power meters have advanced their measurement data output speed another step. Their peak and average power sensors have a wider video bandwidth, and their DSP-based circuitry is designed for 20 megasamples per second (Msa/s) data sampling in the analog-to-digital converter section. See *Fundamentals Part 2*, Chapter V for complete details.

This permits data outputs up to 1000 corrected readings per second, which can be ideal for certain production test situations. Further, because they can internally compute combined parameters like peak-to-average ratio on the fly, important production test requirements are easier to meet.

Keysight P-Series power meters have the fastest measurement speed of 1500 corrected readings/second, which is ideal for manufacturing applications. There is an EEPROM in the sensor that stores the 4-D calibration model. This model is generated in the factory during the calibration process by measuring the input power, frequency, temperature, and output voltage. While performing normal measurements, this model evaluates the current temperature and input frequency to determine the correction factor. It does not require the meter to perform interpolation of calibration factors and linearity curves. Therefore, this results in quick and more accurate measurements.

Susceptibility to overload

The maximum RF power that may be applied to any power sensor is limited in three ways. The first limit is an average power rating. Too much average power usually causes damage because of excessive accumulated heat. The second limit is the total energy in a pulse. If the pulse power is too high for even a very short time, in spite of the average power being low, the pulses might cause a temporary hot spot somewhere in the sensor. Damage occurs before the heat has time to disperse to the rest of the sensor. The third limit is peak envelope power. This limit is usually determined by voltage breakdown phenomena that damages sensor components.

Overload limits are usually stated on the manufacturer's data sheet. None of the three limits should be exceeded. The power limits of any sensor may be moved upward by adding an attenuator to pre-absorb the bulk of the power. Then the power limits are likely to be dictated by the attenuator characteristics, which, being a passive component, are often fairly rugged and forgiving.

Table 3-1 shows that the 8481H power sensor, which consists of a 20-dB attenuator integrated with a thermocouple sensor element, excels in resistance to overload. One characteristic, which might be important but not obvious from the chart, is the ratio of maximum average power to the largest measurable power. The 8481D PDB sensor can absorb 100 mW (+20 dBm) of average power, yet the high end of its measurement range is 10 μ W (–20 dBm). This means that the PDB diode is forgiving in situations where the power level is accidentally set too high. A mistake of 10 dB in setting a source output attenuator, during a measuring routine will merely cause an off-scale reading for the 8481D. The same mistake might damage the other sensors. Excessive power is, by far, the primary cause of power sensor failure.

The diode-stack-attenuator-diode stack topology of the Keysight E9300A average power sensors provides a maximum average power specification of 316 mW (+25 dBm) and peak power specification of 2 W (+33 dBm) for less than a 10 μ S duration. These specifications allow the E9300A sensors to handle the large crest factors typical of the newest signal formats, such as W-CDMA and orthogonal frequency division multiplexing (OFDM), while still maximizing the dynamic range.

Although intended for handling pulsed signals, peak and average sensors, typified by the E9320A sensor, are not necessarily more immune to overload limits. In fact, it might be argued that the user needs to exert even more caution when using pulsed power signals, especially if the actual peak power is unknown. One simple way to do this is to insert a step attenuator between the unknown pulsed power and the peak and average sensor and set in an appropriate amount of attenuation. Since peak and average sensors have an excellent dynamic range, the meter will indicate some peak power on the high sensitivity ranges. At that point, the user can determine whether the test signal peak power will do damage to the sensor.

Table 3-1. Overload characteristics for various types of power sensors.

	8478B Thermistor sensor	8481A Thermo- couple sensor	8481H Thermo- couple sensor	8481D Diode sensor	E4412A Extended- range diode sensor	E9300A Two-path diode sensor	E9320A Peak and average diode sensor	N1921A/22A Peak and average diode sensor
Maximum average power	30 mW	300 mW	3.5 W	100 mW	200 mW	316 mW	200 mW	200 mW
Maximum energy per pulse	10 W \cdot μ S	30 W \cdot μ S	100 W \cdot μ S	See Footnote 1	See Footnote 1	See Footnote 1	See Footnote 1	See Footnote 1
Peak power	200 mW	15 W	100 W	100 mW	200 mW	2 W (< 10 μ S)	1 W (< 10 μ S)	1 W (< 1 μ s)

1. Diode device response is so fast, device cannot average out high-energy pulses

Signal waveform effects

While the waveform considerations were fully covered in *Fundamentals Part 2*, Chapter IV, it is well to consider the waveform factor as a differentiator for the various meters and sensor technology. Briefly, the thermistor is a totally heat-based sensor and therefore the thermistor sensors handle any input waveform with any arbitrary crest factor, that is, they are true square law sensing elements.

Thermocouple sensors are full square law sensing for the same reason, but thermocouples operate beyond the thermistor high power limit of 10 mW, all the way to 100 mW and 3 W for the 848X H-models, which have the integrated fixed pads. The 8481B features a 25-watt external characterized attenuator and operates from 10 MHz to 18 GHz for medium power applications.

PDB-diode-based sensors of the 8481D family feature full square-law performance because their operating power range is limited to a top level of -20 dBm, thus restricting their meter indications to the square-law range of diodes. The user should assure that peak power excursions do not exceed -20 dBm.

The E Series diode sensors (E441XA CW, E9300 average and E9320 peak and average) require simple attenuation to their input signal characteristics. CW signals may be applied all the way from -70 to $+20$ dBm with confidence and accuracy, using the E441XA sensors.

E932X peak and average sensors are intended for characterizing the power of complex modulation formats. Thus their main purpose is to high-speed sample the detected power envelope and compute various types of power parameters. When used with their companion EPM-P power meter, the 20 Msa/s data sampling rates permit fast data acquisition and combined parameter outputs, such as peak-to-average power ratios for specified time-gated periods as defined by wireless system specifications.

The N1921/22A peak and average power sensors, when used with the N1911/12A power meters, provide up to 30 MHz of video bandwidth. They are intended to measure output power and timing parameters of fast radar pulses and wide bandwidth wireless signal formats such as W-CDMA, WLAN, OFDM, WiMAX, and others ranging from -35 to 20 dBm.

Computed data and analyzer software package

As fully described in Chapter V of *Fundamentals Part 2*, the design strategy for the EPM-P power meters includes highly-versatile user-selectable data computation and display features. Gated data features the ability to set specific gate periods for time-selective power periods, and then combine several data points into more desired system parameters such as peak-to-average power ratios.

The EPM-P power meters support the innovative and powerful Keysight VEE analyzer software package, which places the meters totally in the control of the user's PC or laptop. This VEE software package is available free of charge.[1] It operates via the GPIB, and provides the statistical, power, frequency, and time measurements that are required for CDMA and TDMA signal formats. The CD-ROM package includes a VEE installation program.

The statistical package includes the ability to capture

1. cumulative distribution function (CDF)
2. complementary CDF (CCDF or 1-CDF)
3. probability density function (PDF)

These are crucial diagnostic parameters for system signals like CDMA formats. For example, analyzing such power distribution computations can reveal how a power amplifier may be distorting a broadband signal that it is transmitting. Or a baseband DSP signal designer can completely specify the power distribution characteristics to the associated RF subsystem designers.

For traditional pulse work, the analysis package also includes a powerful pulse characterization routine. It computes and displays the following power parameters: pulse top, pulse base, distal, mesial, proximal, peak, average, peak/average ratio, burst average, and duty cycle. It does the same for these time and frequency parameters: rise time, fall time, pulse repetition frequency (PRF), pulse repetition interval (PRI), pulse width and off time. All of these pulsed power parameters were originally defined with the 1990 introduction of the Keysight 8990A peak power analyzer, and are described in Chapter II of *Fundamentals Part 1*.

[1] CD-ROM: EPM and EPM-P Series Power Meters, part number E4416-90032.

This CD-ROM contains the power meters and sensors Learnware (User's Guides, Programming Guides, Operating Guides and Service Manuals). The CD-ROM also contains technical specifications, data sheets, product overviews, configuration guides, application and product notes, as well as power meter tutorials, analyzer software for the EPM-P power meters, IVI-COM drivers, IntuiLink toolbar for the EPM power meters and VXIplug&play drivers for the EPM power meters.

This versatile CD-ROM package is shipped free with every EPM and EPM-P series power meter. Most of the information is also available at www.Keysight.com/find/powermeters.

Capabilities Overview of Keysight Sensors and Power Meters

An applications overview of Keysight sensors

In general, power sensors are designed to match user signal formats and modulation types. Similarly, power meters are designed to match the user's testing configurations and measurement data requirements. Thus, it is the user's responsibility to understand the test signals in detail, the technology interaction with the sensor capabilities, and combine those results with the optimum power meter to match the data output needs of the test combination.

Table 4-1 presents an overview of the most common signal formats in various industry segments and suggests appropriate sensor technologies that can characterize them. (Since Keysight thermistor sensor/meter technology is almost uniquely metrology- and traceability-based, they are not included in Table 4-1.)

Table 4-1. Keysight sensor vs signals application chart

Signal Characteristics

	CW		Modulated				Wireless standards		
	CW	Pulse/ averaged	Pulse/ profiled	AM/FM					
Typical application examples	Metrology lab	Radar/navigation	Radar/navigation	Mobile radio	TDMA GSM EDGE NADC IDEN	cdmaOne <i>Bluetooth</i> TM	W-CDMA cdma2000 [®]	802.11a/b/g MCPA HiperLan2 WiMAX [®]	
Thermocouple sensors	•	•		•	• Avg. only	• Avg. only	• Avg. only	• Avg. only	
Diode sensors	•	•		•	• Avg. only	• Avg. only	• Avg. only	• Avg. only	
Sensor technology	Diode sensors compensated for extended range	•		FM only					
	Two-path diode-stack sensors	•	•	•	• Avg. only	• Avg. only	• Avg. only	• Avg. only	
Peak and average diode sensors (video BW) ¹	•	•	• (30 MHz)	• (30 MHz)	• (300 kHz)	(1.5 MHz) peak, avg, peak/ avg	(5 MHz) peak, avg, peak/ avg	(30 MHz) peak, avg, peak/ avg	

1. The video bandwidth is sometimes referred to as the modulation bandwidth.

A capabilities overview of Keysight power meters

Once the signal and modulation format leads you to the best sensor choice, the power meter decision is straightforward. Table 4-2 compares the performance of Keysight's present power meter line of products. Generally the Keysight EPM, EPM-P, and new P-Series power meters are completely backward compatible with all diode and thermocouple sensors. This includes sensors of a vintage from several decades back. So, the power meter decision becomes mostly a matter of single vs. dual channel capability. The VXI power meter (E1416A) would be chosen for installations which use the plug-in instrumentation concept.

Table 4-2. Keysight's family of power meters

Keysight model	Name	Remarks
Peak and average power meters P-Series		
N1911A	Single-channel	Digital, programmable, peak, and average measurements, uses N192½2A sensors. Perform accurate and repeatable power, time, and statistical measurements up to 300 MHz (video bandwidth). 100 Msamples/sec. Continuous sampling.
N1912A	Dual-channel	Two channel version of N1911A. Measures and computes parameters between the two sensors.
Peak and average power meters EPM-P series		
E4416A	Single-channel	Digital, programmable, peak and average measurements, uses E9320 series sensors. Innovative time-gated pulse-power measurements. 20 M samples/sec.
E4417A	Dual-channel	Two-channel version of E4416A, plus measures and computes parameters between the two sensors.
Averaging power meters EPM series		
E4418B	Single-channel	Digital, programmable, uses E-series and 8480 series sensors, reads EEPROM-stored sensor calibration factors of E-series sensors.
E4419B	Dual-channel	Two-channel version of E4418B, plus measures and computes parameters between the two sensors.
System power meter		
E1416A	VXI power meter	Has functional performance features of previous model 437B; uses all 8480-series sensors.
Thermistor power meter		
432A	Thermistor power	DC-substitution, balanced-bridge technology, ideal for meter reference power transfers.

Table 4-3 presents a compatibility chart for combinations of sensors and meters.

Table 4-3. Keysight power meter/sensor compatibility chart

Keysight power meters

Type > Keysight power sensors	P-Series peak, average, and time gating N1911A single Ch N1912A dual Ch	EPM-P series peak, average and time gating E4416A single Ch E4417A dual Ch	EPM series averag- ing E4418B single Ch E4419B dual Ch	System power meter E1416A VXI	Thermistor power meter 432A
Thermocouple 8480A/B/ H-family R/ Q8486A W/G (11 models)	●	●	●	●	●
Diode 8480D-family 8486A/D-W/ G-family (7 models)	●	●	●	●	●
Diode sensors with extended range E4412A/13A (2 models)	●	●	●	●	
Two-path-diode-stack E9300 family (7 models)	●	●	●	●	
Peak and average sensors E9320 family (6 models)	●	●			
Thermistor sensors 478 coaxial 486 waveguide (6 models)					●
Peak and average sensor N1921A/22A 30 MHz video bandwidth (2 models)	●				

Finally, the last user-selection step is to decide on the specific power sensor, which matches the signal format, power dynamic range and frequency range of the application. The technology considerations of Fundamentals Part 2 might be consulted for more detail on performance and functionality. The five charts of Table 4-4 classify the various sensor technologies and their frequency and power level coverage.

Table 4-4. Keysight’s five families of power sensors

Thermocouple sensors

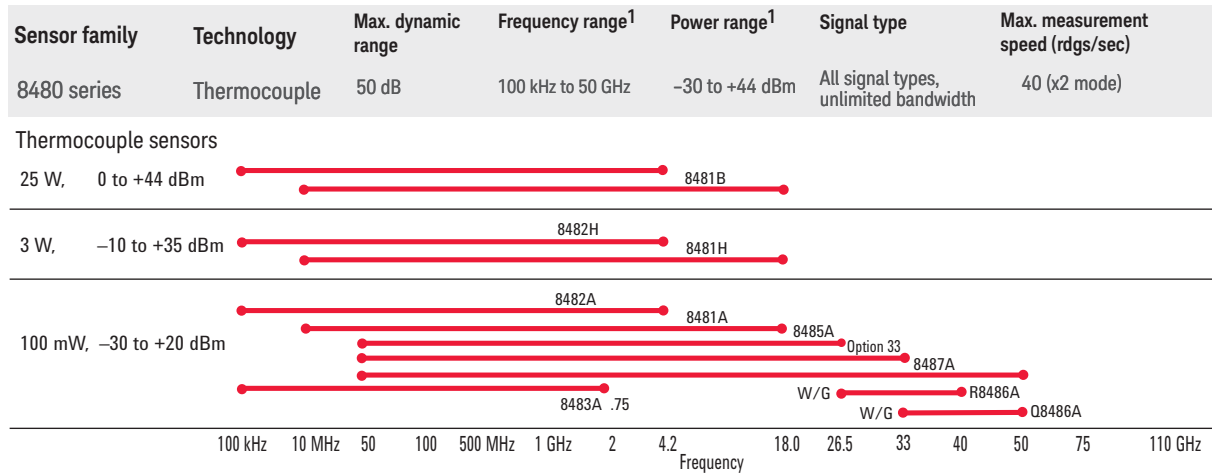

Diode sensors

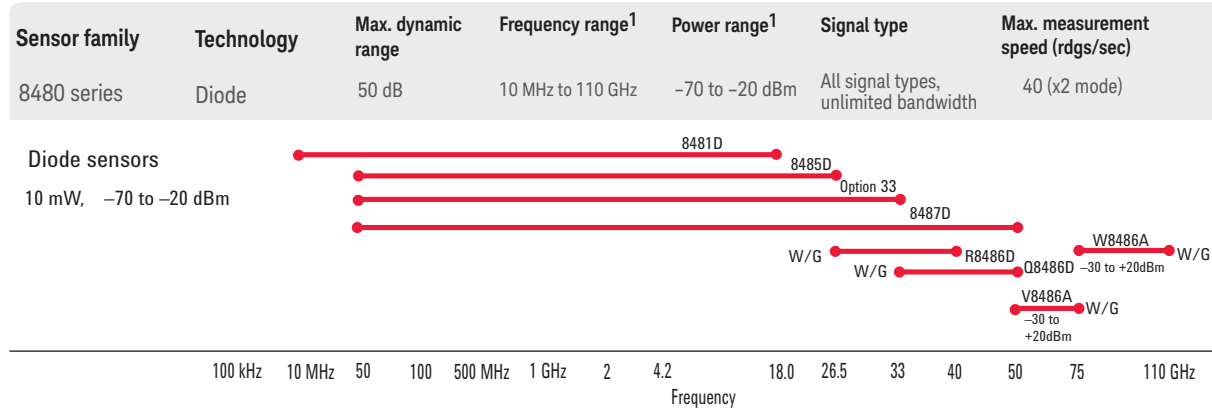

1. Sensor dependent

Extended range diode sensors

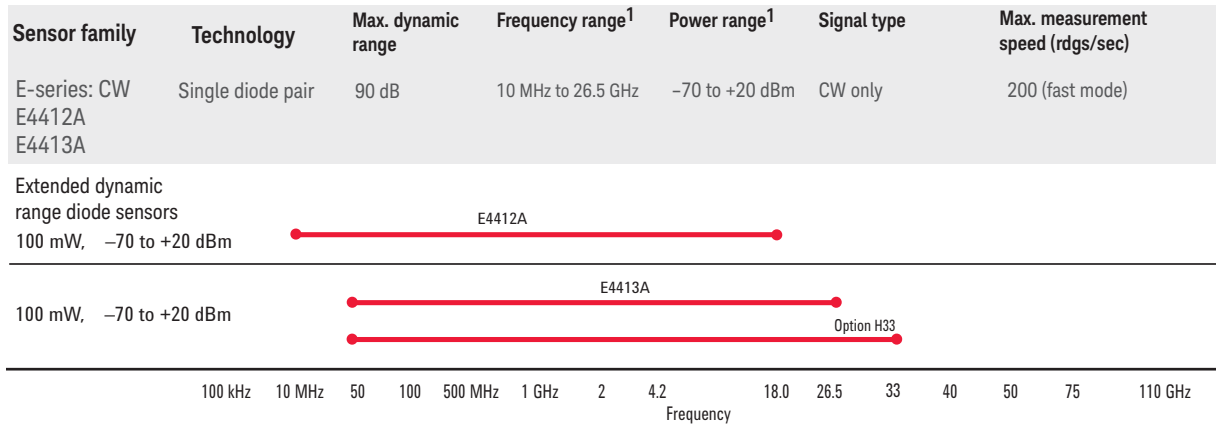

Two-path diode stack sensors

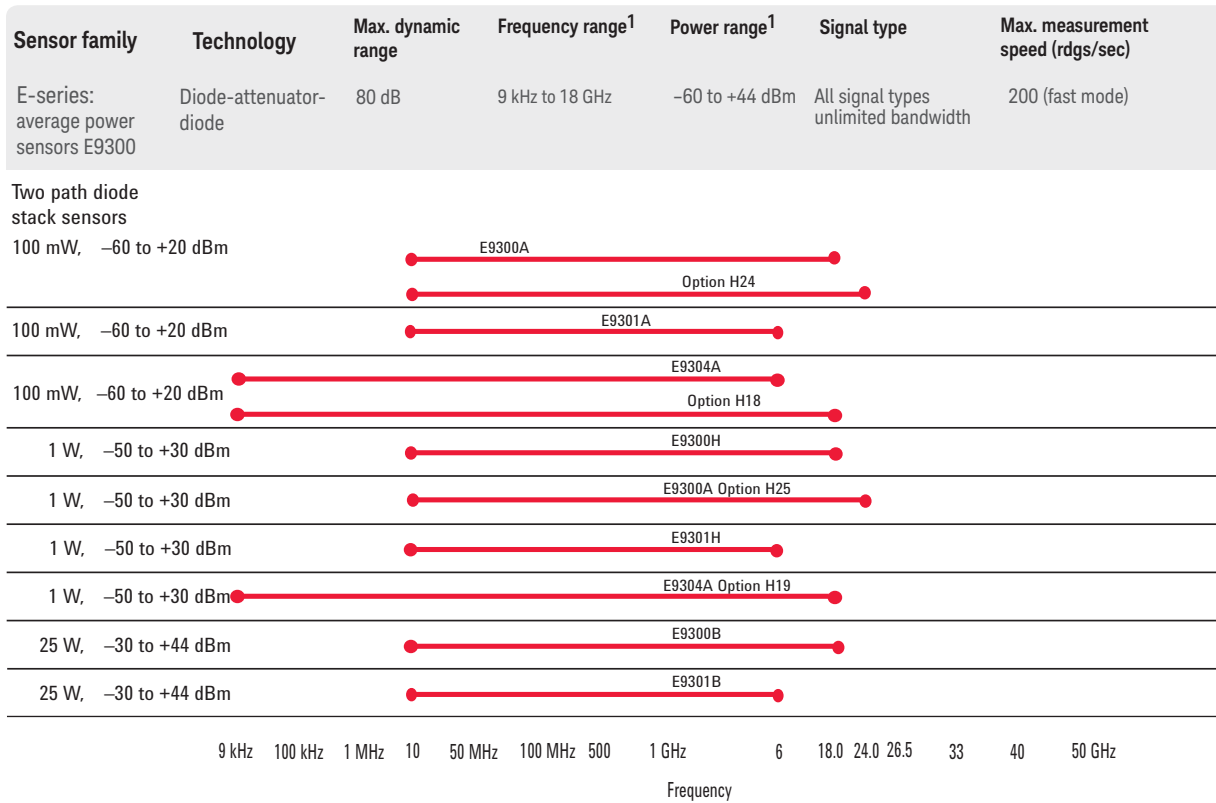

1. Sensor dependent

Peak and average sensors

Sensor family	Technology	Max. dynamic range	Frequency range ¹	Power range ¹	Signal type	Max. measurement speed (rdgs/sec)
E9320-series ² peak and average E9321/22/23A E9325/26/27A	Single diode pair, two-path	85 dB	50 MHz to 18 GHz	-65 to +20 dBm	CW, avg, peak, pk/avg, TDMA, W-CDMA	Up to 1000
N1921/22A ³ peak and average sensors	Single diode pair built-in voltage reference for internal zero and calibration	55 dB	50 MHz to 40 GHz	-35 to +20 dBm	CW, avg, peak, pk/avg, TDMA, W-CDMA, radar	Up to 1500

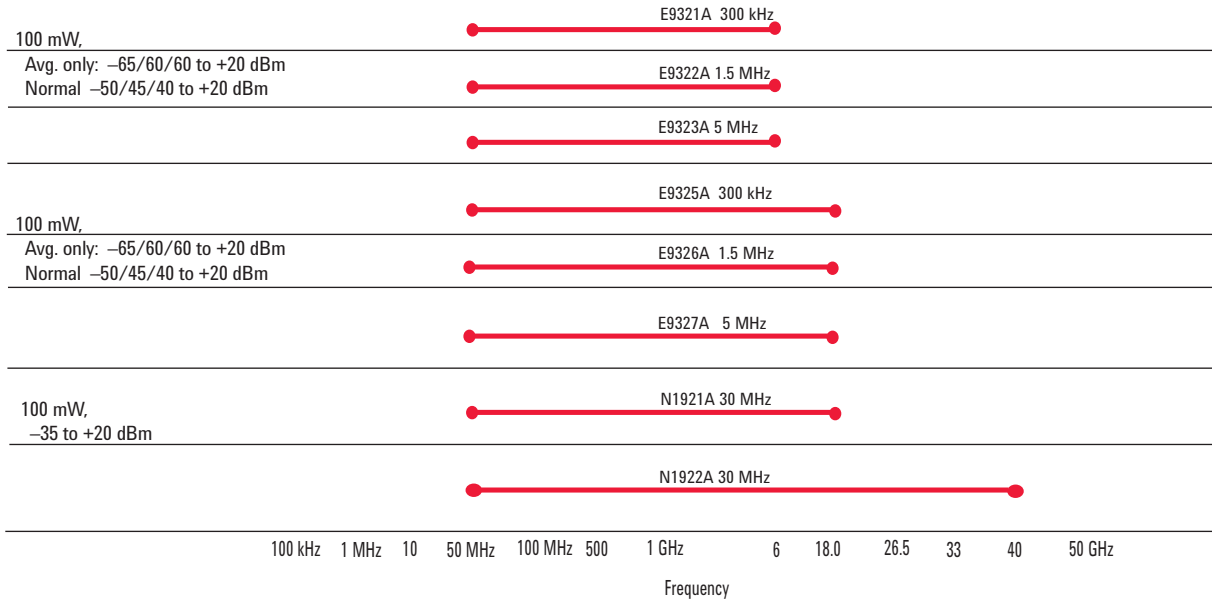

1. Sensor dependent
2. Peak and average sensors must be used with an E9288A, B, or C sensor cable, and only operate with the E4416A/17A power meters
3. E9320 Series sensors, when used with the E4416A/17A power meters, must be used with E9288A/B/C sensor cables. When used with the N1911A/12A power meters, they must be used with the N1917A/B/C sensor cables.

myKeysight

myKeysight

www.keysight.com/find/mykeysight

A personalized view into the information most relevant to you.

Three-Year Warranty

www.keysight.com/find/ThreeYearWarranty

Keysight's commitment to superior product quality and lower total cost of ownership. The only test and measurement company with three-year warranty standard on all instruments, worldwide.



Keysight Assurance Plans

www.keysight.com/find/AssurancePlans

Up to five years of protection and no budgetary surprises to ensure your instruments are operating to specification so you can rely on accurate measurements.



www.keysight.com/go/quality

Keysight Technologies, Inc.
DEKRA Certified ISO 9001:2008
Quality Management System



Keysight Channel Partners

www.keysight.com/find/channelpartners

Get the best of both worlds: Keysight's measurement expertise and product breadth, combined with channel partner convenience.

Bluetooth and the *Bluetooth* logos are trademarks owned by *Bluetooth* SIG, Inc., U.S.A. and licensed to Keysight Technologies, Inc.

cdma2000 is a US registered certification mark of the Telecommunications Industry Association.

WiMAX, Mobile WiMAX, WiMAX Forum, the WiMAX Forum logo, WiMAX Forum Certified, and the WiMAX Forum Certified logo are US trademarks of the WiMAX Forum.

www.keysight.com/find/add

For more information on Keysight Technologies' products, applications or services, please contact your local Keysight office. The complete list is available at: www.keysight.com/find/contactus

Americas

Canada	(877) 894 4414
Brazil	55 11 3351 7010
Mexico	001 800 254 2440
United States	(800) 829 4444

Asia Pacific

Australia	1 800 629 485
China	800 810 0189
Hong Kong	800 938 693
India	1 800 112 929
Japan	0120 (421) 345
Korea	080 769 0800
Malaysia	1 800 888 848
Singapore	1 800 375 8100
Taiwan	0800 047 866
Other AP Countries	(65) 6375 8100

Europe & Middle East

Austria	0800 001122
Belgium	0800 58580
Finland	0800 523252
France	0805 980333
Germany	0800 6270999
Ireland	1800 832700
Israel	1 809 343051
Italy	800 599100
Luxembourg	+32 800 58580
Netherlands	0800 0233200
Russia	8800 5009286
Spain	800 000154
Sweden	0200 882255
Switzerland	0800 805353
	Opt. 1 (DE)
	Opt. 2 (FR)
	Opt. 3 (IT)
United Kingdom	0800 0260637

For other unlisted countries:
www.keysight.com/find/contactus
(BP-09-23-14)