

Technical Specifications

Agilent Technologies PNA Series Network Analyzers E8356A, E8357A, and E8358A



Agilent Technologies

Document Part Number: 5989-1077ENUS

Printed in USA

April 23, 2004

© Copyright 2004 Agilent Technologies, Inc. All rights reserved.

Documentation Warranty

THE MATERIAL CONTAINED IN THIS DOCUMENT IS PROVIDED "AS IS," AND IS SUBJECT TO BEING CHANGED, WITHOUT NOTICE, IN FUTURE EDITIONS. FURTHER, TO THE MAXIMUM EXTENT PERMITTED BY APPLICABLE LAW, AGILENT DISCLAIMS ALL WARRANTIES, EITHER EXPRESS OR IMPLIED WITH REGARD TO THIS MANUAL AND ANY INFORMATION CONTAINED HEREIN, INCLUDING BUT NOT LIMITED TO THE IMPLIED WARRANTIES OF MERCHANTABILITY AND FITNESS FOR A PARTICULAR PURPOSE. AGILENT SHALL NOT BE LIABLE FOR ERRORS OR FOR INCIDENTAL OR CONSEQUENTIAL DAMAGES IN CONNECTION WITH THE FURNISHING, USE, OR PERFORMANCE OF THIS DOCUMENT OR ANY INFORMATION CONTAINED HEREIN. SHOULD AGILENT AND THE USER HAVE A SEPARATE WRITTEN AGREEMENT WITH WARRANTY TERMS COVERING THE MATERIAL IN THIS DOCUMENT THAT CONFLICT WITH THESE TERMS, THE WARRANTY TERMS IN THE SEPARATE AGREEMENT WILL CONTROL.

DFARS/Restricted Rights Notice

If software is for use in the performance of a U.S. Government prime contract or subcontract, Software is delivered and licensed as "Commercial computer software" as defined in DFAR 252.227-7014 (June 1995), or as a "commercial item" as defined in FAR 2.101(a) or as "Restricted computer software" as defined in FAR 52.227-19 (June 1987) or any equivalent agency regulation or contract clause. Use, duplication or disclosure of Software is subject to Agilent Technologies' standard commercial license terms, and non-DOD Departments and Agencies of the U.S. Government will receive no greater than Restricted Rights as defined in FAR 52.227-19(c)(1-2) (June 1987). U.S. Government users will receive no greater than Limited Rights as defined in FAR 52.227-14 (June 1987) or DFAR 252.227-7015 (b)(2) (November 1995), as applicable in any technical data.

Contacting Agilent

Online assistance: www.agilent.com/find/assist

Americas			
Brazil <i>(tel)</i> (+55) 11 4197 3600 <i>(fax)</i> (+55) 11 4197 3800	Canada <i>(tel)</i> 877 894 4414 <i>(fax)</i> (+1) 905 282-6495	Mexico <i>(tel)</i> (+52) 55 5081 9469 <i>(alt)</i> 01800 5064 800 <i>(fax)</i> (+52) 55 5081 9467	United States <i>(tel)</i> 800 829 4444 <i>(alt)</i> (+1) 303 662 3998 <i>(fax)</i> 800 829 4433
Asia Pacific and Japan			
Australia <i>(tel)</i> 1800 629 485 <i>(alt)</i> 1800 143 243 <i>(fax)</i> 1800 142 134	China <i>(tel)</i> 800 810 0189 <i>(alt)</i> (+86) 10800 650 0021 <i>(fax)</i> 800 820 2816	Hong Kong <i>(tel)</i> 800 930 871 <i>(alt)</i> (+852) 3197 7889 <i>(fax)</i> (+852) 2 506 9233	India <i>(tel)</i> 1600 112 929 <i>(fax)</i> 000800 650 1101
Japan <i>(tel)</i> 0120 421 345 <i>(alt)</i> (+81) 426 56 7832 <i>(fax)</i> 0120 421 678	Malaysia <i>(tel)</i> 1800 888 848 <i>(alt)</i> 1800 828 848 <i>(fax)</i> 1800 801 664	Singapore <i>(tel)</i> 1800 375 8100 <i>(alt)</i> (+65) 6 375 8100 <i>(fax)</i> (+65) 6836 0252	South Korea <i>(tel)</i> 080 769 0800 <i>(alt)</i> (+82) 2 2004 5004 <i>(fax)</i> (+82) 2 2004 5115
Taiwan <i>(tel)</i> 0800 047 866 <i>(alt)</i> 00801 651 317 <i>(fax)</i> 0800 286 331	Thailand <i>(tel)</i> 1800 226 008 <i>(alt)</i> (+66) 2 268 1345 <i>(fax)</i> (+66) 2 661 3714		
Europe			
Austria <i>(tel)</i> 0820 87 44 11* <i>(fax)</i> 0820 87 44 22	Belgium <i>(tel)</i> (+32) (0)2 404 9340 <i>(alt)</i> (+32) (0)2 404 9000 <i>(fax)</i> (+32) (0)2 404 9395	Denmark <i>(tel)</i> (+45) 7013 1515 <i>(alt)</i> (+45) 7013 7313 <i>(fax)</i> (+45) 7013 1555	Finland <i>(tel)</i> (+358) 10 855 2100 <i>(fax)</i> (+358) 10 855 2923
France <i>(tel)</i> 0825 010 700* <i>(alt)</i> (+33) (0)1 6453 5623 <i>(fax)</i> 0825 010 701*	Germany <i>(tel)</i> 01805 24 6333* <i>(alt)</i> 01805 24 6330* <i>(fax)</i> 01805 24 6336*	Ireland <i>(tel)</i> (+353) (0)1 890 924 204 <i>(alt)</i> (+353) (0)1 890 924 206 <i>(fax)</i> (+353) (0)1 890 924 024	Israel <i>(tel)</i> (+972) 3 9288 500 <i>(fax)</i> (+972) 3 9288 501
Italy <i>(tel)</i> (+39) (0)2 9260 8484 <i>(fax)</i> (+39) (0)2 9544 1175	Luxemburg <i>(tel)</i> (+32) (0)2 404 9340 <i>(alt)</i> (+32) (0)2 404 9000 <i>(fax)</i> (+32) (0)2 404 9395	Netherlands <i>(tel)</i> (+31) (0)20 547 2111 <i>(alt)</i> (+31) (0)20 547 2000 <i>(fax)</i> (+31) (0)20 547 2190	Russia <i>(tel)</i> (+7) 095 797 3963 <i>(alt)</i> (+7) 095 797 3900 <i>(fax)</i> (+7) 095 797 3901
Spain <i>(tel)</i> (+34) 91 631 3300 <i>(alt)</i> (+34) 91 631 3000 <i>(fax)</i> (+34) 91 631 3301	Sweden <i>(tel)</i> 0200 88 22 55* <i>(alt)</i> (+46) (0)8 5064 8686 <i>(fax)</i> 020 120 2266*	Switzerland (French) <i>(tel)</i> 0800 80 5353 opt. 2* <i>(alt)</i> (+33) (0)1 6453 5623 <i>(fax)</i> (+41) (0)22 567 5313	Switzerland (German) <i>(tel)</i> 0800 80 5353 opt. 1* <i>(alt)</i> (+49) (0)7031 464 6333 <i>(fax)</i> (+41) (0)1 272 7373
Switzerland (Italian) <i>(tel)</i> 0800 80 5353 opt. 3* <i>(alt)</i> (+39) (0)2 9260 8484 <i>(fax)</i> (+41) (0)22 567 5314	United Kingdom <i>(tel)</i> (+44) (0)7004 666666 <i>(alt)</i> (+44) (0)7004 123123 <i>(fax)</i> (+44) (0)7004 444555		
<i>(tel)</i> = primary telephone number; <i>(alt)</i> = alternate telephone number; <i>(fax)</i> = FAX number; * = in country number			

This page intentionally left blank.

Technical Specifications for the E8356A, E8357A, E8358A

Definitions.....	3
Corrected System Performance.....	4
Table 1. System Dynamic Range.....	4
Corrected System Performance with Type-N Connectors.....	5
Table 2. Corrected System Performance With 85032F Calibration Kit.....	5
Table 3. Corrected System Performance With 85032F Calibration Kit.....	7
Table 4. Corrected System Performance With 85092C ECal Module.....	8
Table 5. Corrected System Performance With 85092C ECal Module.....	9
Corrected System Performance with 3.5 mm Connectors.....	10
Table 6. Corrected System Performance With 85033E Calibration Kit.....	10
Table 7. Corrected System Performance 85033E Calibration Kit.....	12
Table 8. Corrected System Performance With 85093C ECal Module.....	13
Table 9. Corrected System Performance With 85093C ECal Module.....	14
Corrected System Performance with 7-16 Connectors.....	15
Table 10. Corrected System Performance With 85038A Calibration Kit.....	15
Table 11. Corrected System Performance With 85038A Calibration Kit.....	17
Uncorrected Instrument Performance.....	18
Table 12. Uncorrected Instrument Performance.....	18
Test Port Output Characteristics (Source).....	18
Table 13. Test Port Output Frequency.....	18
Table 14. Test Port Output Power.....	19
Table 15. Test Port Output Signal Purity.....	19
Test Port and Receiver Input Characteristics.....	19
Table 16. Test Port and Receiver Input Levels.....	20
Table 17. Test Port Input (Trace Noise).....	21
Table 18. Test Port Input (Reference Level and Stability).....	21
Table 19. Test Port Input (Dynamic Accuracy specification).....	22
Table 20. Test Port Input (Group Delay).....	23
General Information.....	23
Table 21. System Bandwidths.....	23
Table 22. Front Panel Information.....	24
Table 23. Rear Panel Information.....	25
Table 24. Rear Panel Information (continued).....	26
Table 25. Analyzer Environment and Dimensions.....	27
Measurement Throughput Summary.....	28
Table 26. Typical Cycle Time (ms).....	28
Table 27. Cycle Time vs. IF Bandwidth.....	28

Table 28. Cycle Time vs. Number of Points	29
Table 29. Data Transfer Time (ms).....	30
Table 30. Recall and Sweep Speed	31
E8356A, E8357A, and E8358A Simplified Test Set Block Diagram.....	32
E8356A, E8357A, and E8358A with Option 015 Simplified Test Set Block Diagram	33

This is a complete list of the E8356A, E8357A, and E8358A network analyzer technical specifications.

- To optimize viewing of uncertainty curves, click the Maximize button.
- To view or print the PNA Series Data Sheet (a condensed version of the specifications), visit our web site at <http://www.agilent.com/find/pna>, select your analyzer model, and click on the link for the data sheet.
- The uncertainty curves contained in this document apply only to the setup conditions listed. Please download our free Uncertainty Calculator from http://www.agilent.com/find/na_calculator to generate the curves for your PNA setup. View the [equations](#) used to generate the uncertainty curves.

Definitions

All specifications and characteristics apply over a 25 °C \pm 5 °C range (unless otherwise stated) and 90 minutes after the instrument has been turned on.

Specification (spec.): Warranted performance. Specifications include guardbands to account for the expected statistical performance distribution, measurement uncertainties, and changes in performance due to environmental conditions.

Characteristic (char.): A performance parameter that the product is expected to meet before it leaves the factory, but that is not verified in the field and is not covered by the product warranty. A characteristic includes the same guardbands as a specification.

Typical (typ.): Expected performance of an average unit which does not include guardbands. It is not covered by the product warranty.

Nominal (nom.): A general, descriptive term that does not imply a level of performance. It is not covered by the product warranty.

Calibration: The process of measuring known standards to characterize a network analyzer's systematic (repeatable) errors.

Corrected (residual): Indicates performance after **error correction** (calibration). It is determined by the quality of calibration standards and how well "known" they are, plus system repeatability, stability, and noise.

Uncorrected (raw): Indicates instrument performance without error correction. The uncorrected performance affects the stability of a **calibration**.

Standard: When referring to the analyzer, this includes no options unless noted otherwise.

Corrected System Performance

The specifications in this section apply for measurements made with the E8356A, E8357A, and E8358A analyzer with the following conditions:

- 10 Hz IF bandwidth
- No averaging applied to data
- Environmental temperature of 25 °C ±5 °C, with < 1 °C deviation from calibration temperature
- Isolation calibration not omitted

Table 1. System Dynamic Range

Description	Specification (dB)	Characteristic (dB)
Dynamic range^a (at test port)		
300 kHz to 25 MHz ^b	125	
25 MHz to 3 GHz ^b	128	
3 GHz to 6 GHz	118	
6 GHz to 9 GHz	113	
Dynamic range^c (at receiver input)		
300 kHz to 25 MHz ^d		140
25 MHz to 3 GHz ^d		143
3 GHz to 6 GHz		133
6 GHz to 9 GHz		128

a The test port dynamic range is calculated as the difference between the test port rms noise floor and the source maximum output power. The effective dynamic range must take measurement uncertainties and interfering signals into account.

b May be limited to 100 dB at particular frequencies below 750 MHz due to spurious receiver residuals.

c The receiver input dynamic range is calculated as the difference between the receiver rms noise floor and the source maximum output power. The effective dynamic range must take measurement uncertainties and interfering signals into account. This set-up should only be used when the receiver input will never exceed its damage level. When the analyzer is in segment sweep mode, frequency segments can be defined with a higher power level when the extended dynamic range is required (i.e. the portion of the device's response with high insertion loss), and reduced power when receiver damage may occur (i.e. the portion of the device's response with low insertion loss).

d May be limited to 115 dB at particular frequencies below 750 MHz due to spurious receiver residuals.

Note: Receiver Dynamic Range specifications are not included in this E8356/7/8A document.

Corrected System Performance with Type-N Connectors

Note: This document provides technical specifications for the following calibration kits only: 85032F, 85092C, 85033E, 85093C and 85038A.

Table 2. Corrected System Performance With Type-N Device Connectors, 85032F Calibration Kit

Applies to the E8356A, E8357A, and E8358A analyzer, 85032F (Type-N, 50 Ω) calibration kit, N6314A test port cable, and a full 2-port calibration. Also applies to the following conditions:

- IF bandwidth = 10 Hz
- No averaging applied to data
- Environmental temperature 25° \pm 5 °C, with < 1 °C deviation from calibration temperature
- Isolation calibration not omitted

Description	Specification (dB)			
	300 kHz to 1.3 GHz	1.3 GHz to 3 GHz	3 to 6 GHz	6 to 9 GHz
Directivity	49	46	40	38
Source Match	41	40	36	35
Load Match	49	45	39	37
Reflection Tracking	\pm 0.011	\pm 0.021	\pm 0.032	\pm 0.054
Transmission Tracking	\pm 0.011	\pm 0.019	\pm 0.041	\pm 0.051

Transmission Uncertainty (Specifications)

Magnitude

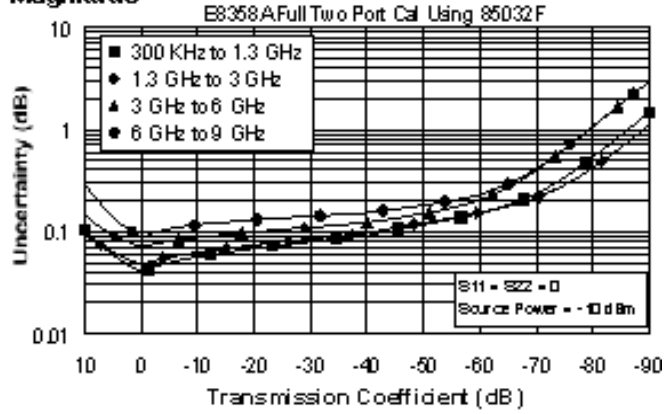

Phase

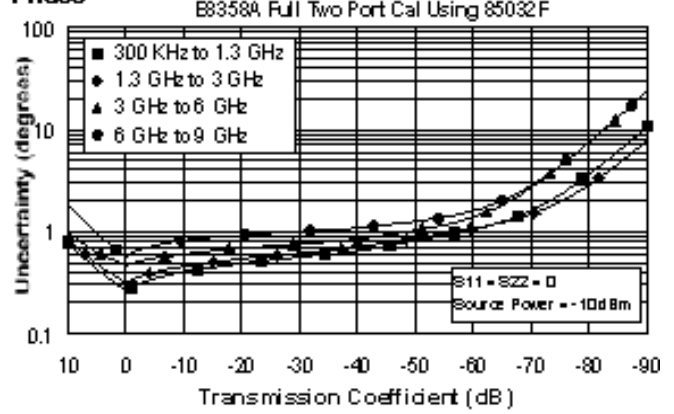

Reflection Uncertainty (Specifications)

Magnitude

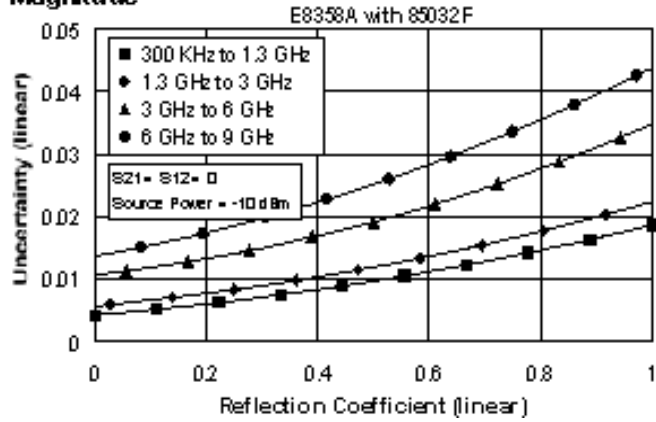

Phase

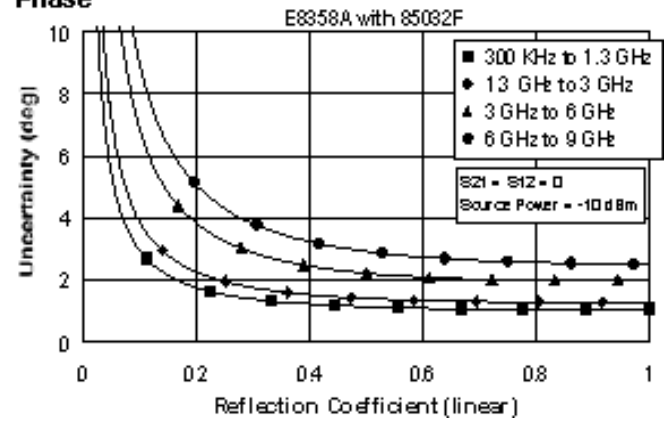

Table 3. Corrected System Performance With Type-N Device Connectors, Option 015 With 85032F Calibration Kit

Applies to the E8356A, E8357A, and E8358A analyzer with Option 015, 85032F (Type-N, 50Ω) calibration kit, N6314A test port cable, and a full 2-port calibration. Also applies to the following conditions:

- IF bandwidth = 10 Hz
- No averaging applied to data
- Environmental temperature 25° ±5 °C, with < 1 °C deviation from calibration temperature
- Isolation calibration not omitted

Description	Specification (dB)			
	300 kHz to 1.3 GHz	1.3 GHz to 3 GHz	3 to 6 GHz	6 to 9 GHz
Directivity	49	46	40	38
Source Match	41	40	36	35
Load Match	49	45	39	37
Reflection Tracking	±0.011	±0.021	±0.032	±0.054
Transmission Tracking	±0.011	±0.024	±0.052	±0.065

Transmission Uncertainty (Specifications)

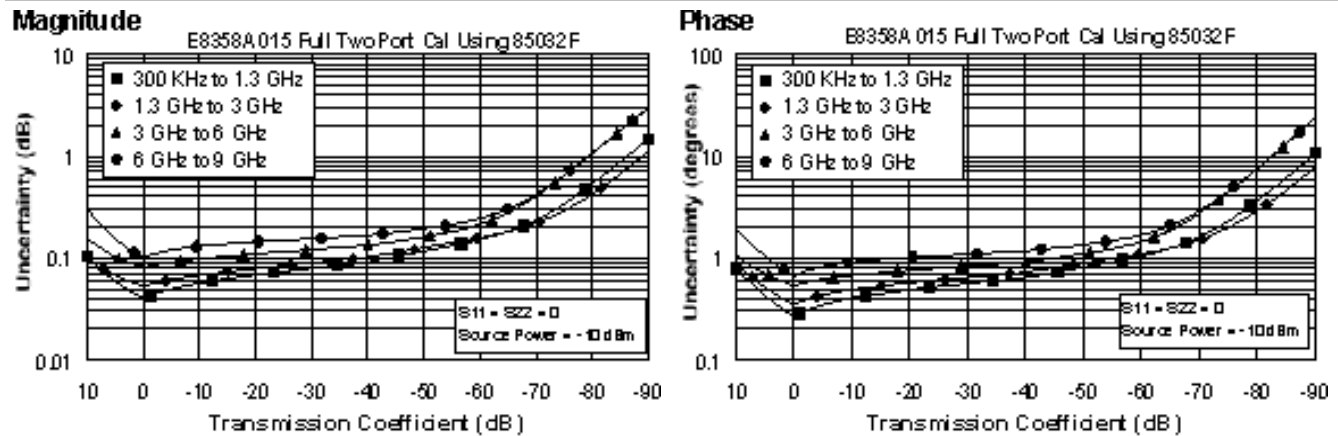

Reflection Uncertainty (Specifications)

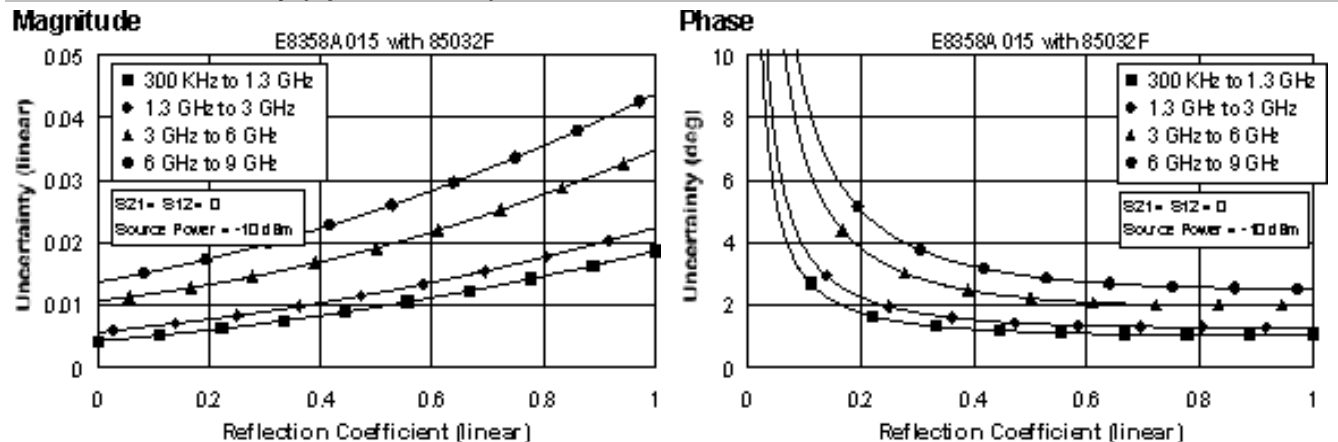

Table 4. Corrected System Performance With Type-N Device Connectors, 85092C Electronic Calibration Module

Applies to the E8356A, E8357A, and E8358A analyzer, 85092C (Type-N, 50Ω) electronic calibration (ECal) module, N6314A test port cable, and a full 2-port calibration. Also applies to the following conditions:

- IF bandwidth = 10 Hz
- No averaging applied to data
- Environmental temperature 25° ±5 °C, with < 1 °C deviation from calibration temperature
- Isolation calibration not omitted

Description	Specification (dB)			
	300 kHz to 1.3 GHz	1.3 GHz to 3 GHz	3 to 6 Hz	6 to 9 GHz ^a
Directivity	52	54	52	47
Source Match	45	44	41	36
Load Match	47	47	44	39
Reflection Tracking	±0.040	±0.040	±0.060	±0.070
Transmission Tracking	±0.039	±0.039	±0.068	±0.135

Transmission Uncertainty (Specifications)

Magnitude

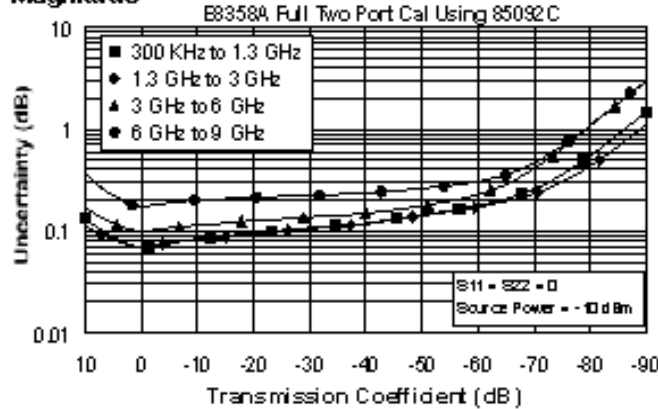

Phase

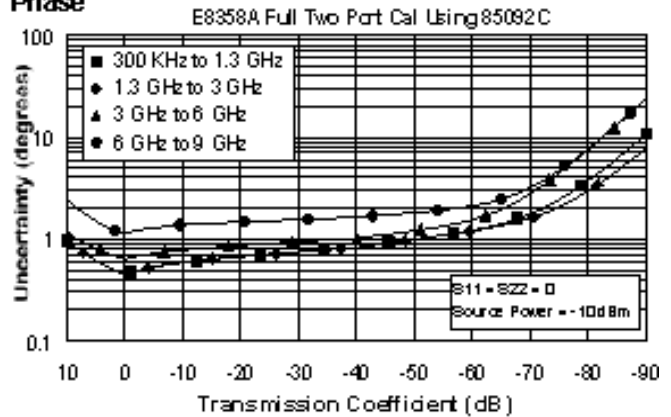

Reflection Uncertainty (Specifications)

Magnitude

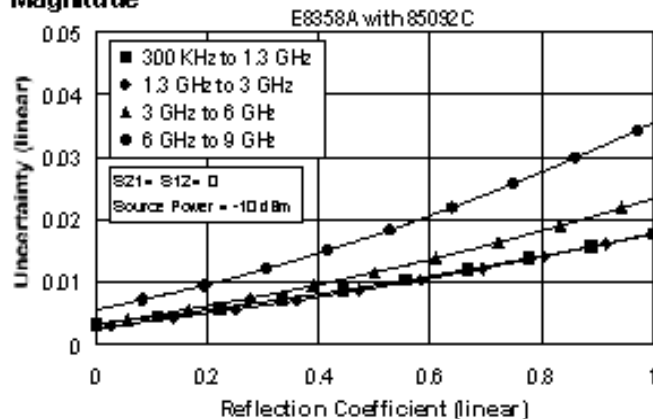

Phase

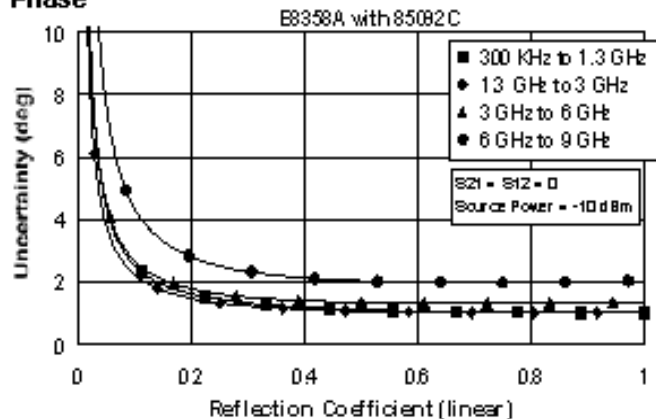

Table 5. Corrected System Performance With Type-N Device Connectors, Option 015 With 85092C Electronic Calibration Module

Applies to the E8356A, E8357A, and E8358A analyzer with Option 015, 85092C (Type-N, 50Ω) electronic calibration (ECal) module, N6314A test port cable, and a full 2-port calibration. Also applies to the following conditions:

- IF bandwidth = 10 Hz
- No averaging applied to data
- Environmental temperature 25° ±5 °C, with < 1 °C deviation from calibration temperature
- Isolation calibration not omitted

Description	Specification (dB)			
	300 kHz to 1.3 GHz	1.3 GHz to 3 GHz	3 to 6 GHz	6 to 9 GHz ^a
Directivity	52	54	52	47
Source Match	45	44	41	36
Load Match	47	47	44	39
Reflection Tracking	±0.040	±0.040	±0.060	±0.070
Transmission Tracking	±0.039	±0.039	±0.068	±0.135

Transmission Uncertainty (Specifications)

Magnitude

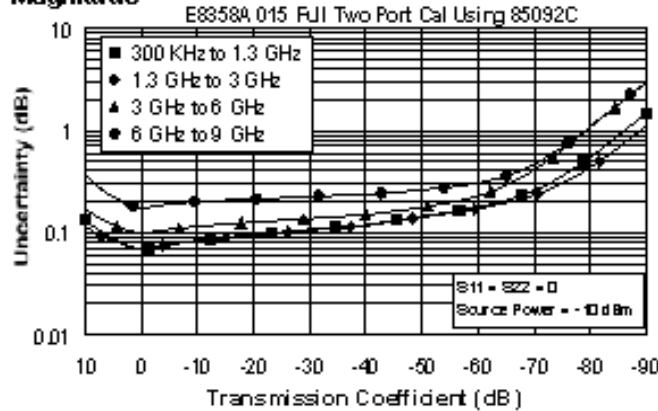

Phase

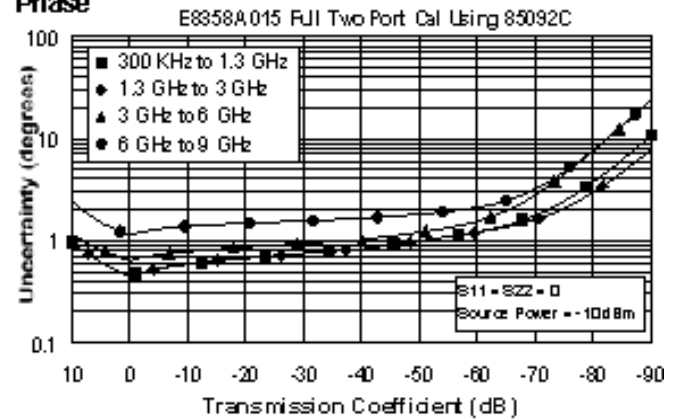

Reflection Uncertainty (Specifications)

Magnitude

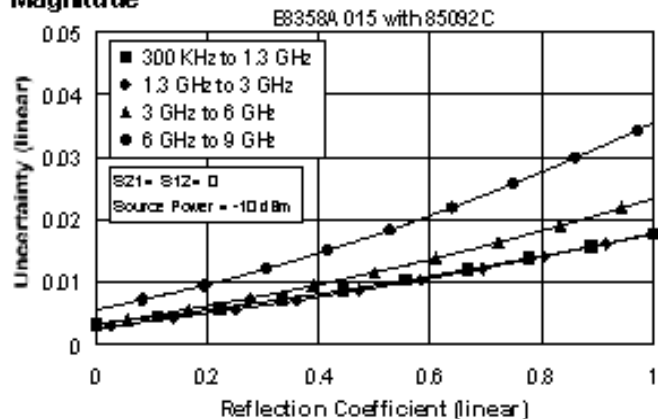

Phase

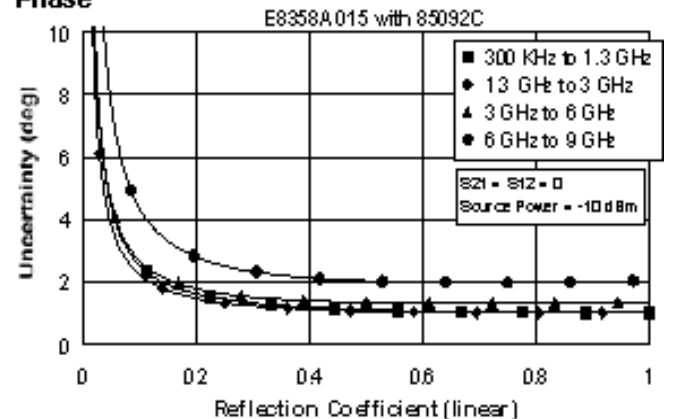

Corrected System Performance with 3.5 mm Connectors

Table 6. Corrected System Performance With 3.5 mm Device Connector Type, 85033E Calibration Kit

Applies to the E8356A, E8357A, and E8358A analyzer, 85033E (3.5 mm, 50Ω) calibration kit, N6314A test port cable, and a full 2-port calibration. Also applies to the following conditions:

- IF bandwidth = 10 Hz
- No averaging applied to data
- Environmental temperature 25° ±5 °C, with < 1 °C deviation from calibration temperature
- Isolation calibration not omitted

Description	Specification (dB)			
	300 kHz to 1.3 GHz	1.3 GHz to 3 GHz	3 to 6 GHz	6 to 9 GHz
Directivity	46	44	38	38
Source Match	43	40	37	36
Load Match	46	44	38	38
Reflection Tracking	±0.006	±0.007	±0.009	±0.010
Transmission Tracking	±0.011	±0.020	±0.041	±0.047

Transmission Uncertainty (Specifications)

Magnitude

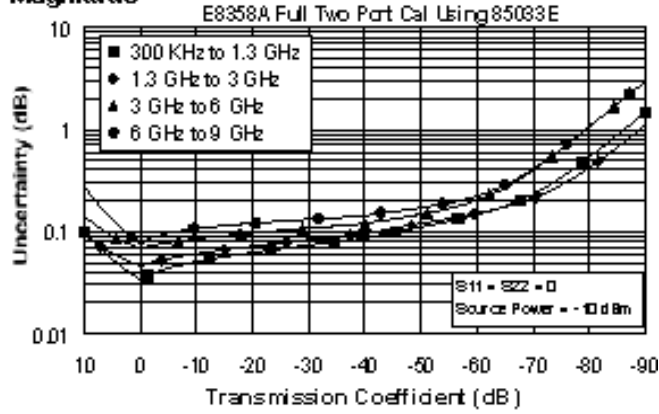

Phase

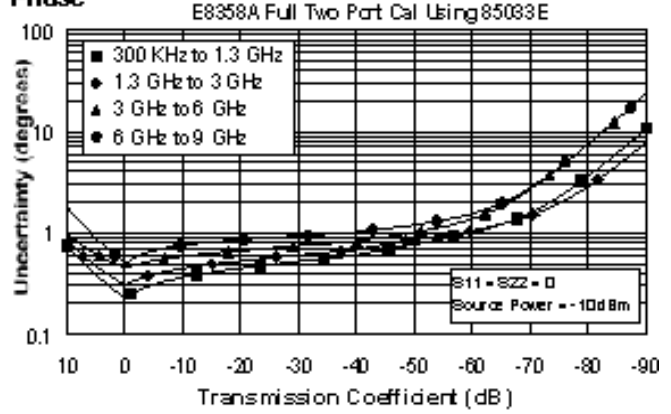

Reflection Uncertainty (Specifications)

Magnitude

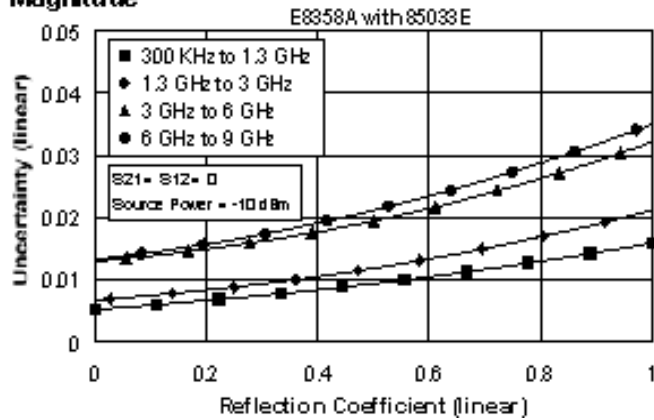

Phase

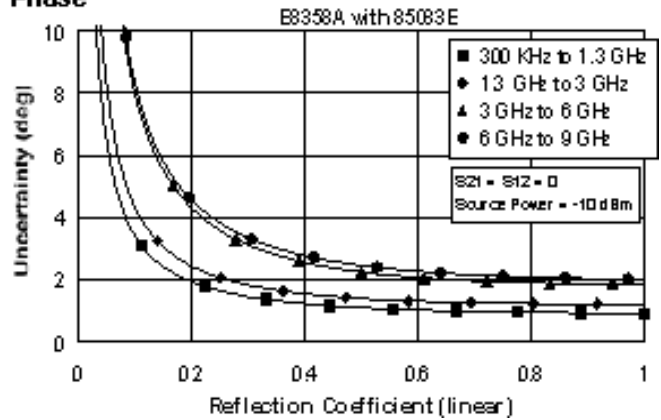

Table 7. Corrected System Performance With 3.5 mm Device Connector Type, Option 015 With 85033E Calibration Kit

Applies to the E8356A, E8357A, and E8358A analyzer with Option 015, 85033E (3.5 mm, 50Ω) calibration kit, N6314A test port cable, and a full 2-port calibration. Also applies to the following conditions:

- IF bandwidth = 10 Hz
- No averaging applied to data
- Environmental temperature 25° ±5 °C, with < 1 °C deviation from calibration temperature
- Isolation calibration not omitted

Description	Specification (dB)			
	300 kHz to 1.3 GHz	1.3 GHz to 3 GHz	3 to 6 GHz	6 to 9 GHz
Directivity	46	44	38	38
Source Match	43	40	37	36
Load Match	46	44	38	38
Reflection Tracking	±0.006	±0.007	±0.009	±0.010
Transmission Tracking	±0.011	±0.025	±0.052	±0.059

Transmission Uncertainty (Specifications)

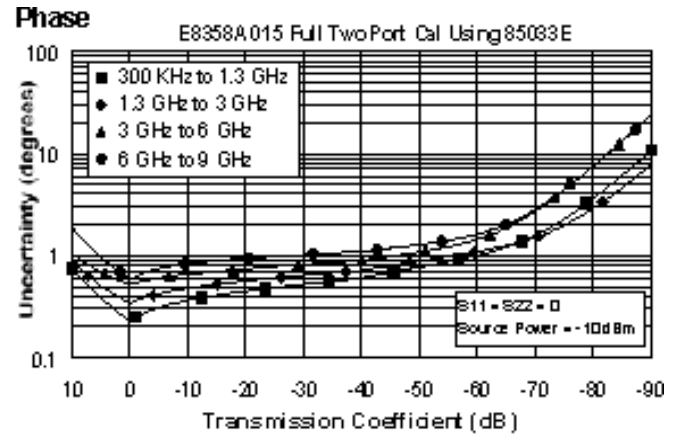
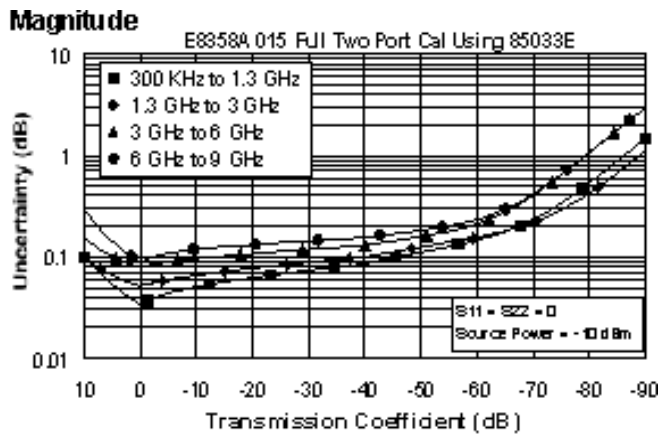

Reflection Uncertainty (Specifications)

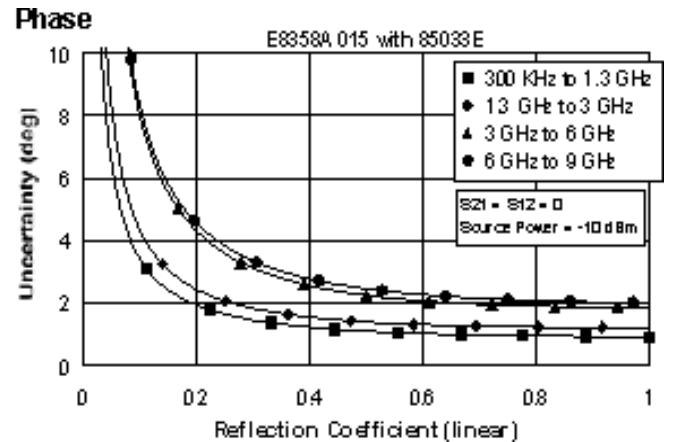
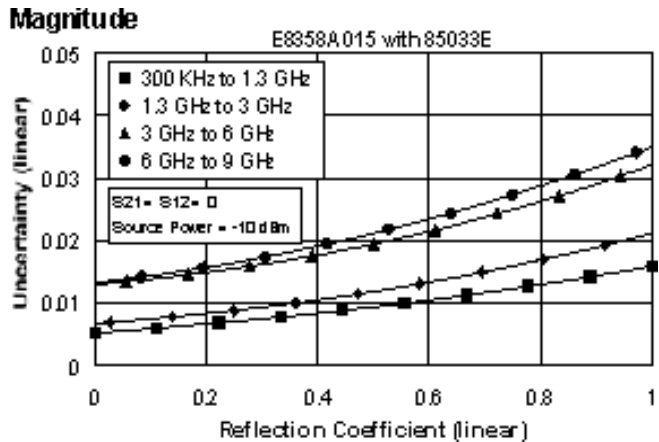

Table 8. Corrected System Performance With 3.5 mm Device Connector Type, 85093C Electronic Calibration Module

Applies to the E8356A, E8357A, and E8358A analyzer, 85093C (3.5 mm, 50Ω) electronic calibration (ECal) module, N6314A test port cable, and a full 2-port calibration. Also applies to the following conditions:

- IF bandwidth = 10 Hz
- No averaging applied to data
- Environmental temperature 25° ±5 °C, with < 1 °C deviation from calibration temperature
- Isolation calibration not omitted

Description	Specification (dB)			
	300 kHz to 1.3 GHz	1.3 GHz to 3 GHz	3 to 6 GHz	6 to 9 GHz ^a
Directivity	52	52	51	47
Source Match	44	44	39	34
Load Match	47	47	44	40
Reflection Tracking	±0.030	±0.040	±0.050	±0.070
Transmission Tracking	±0.039	±0.049	±0.068	±0.116

Transmission Uncertainty (Specifications)

Magnitude

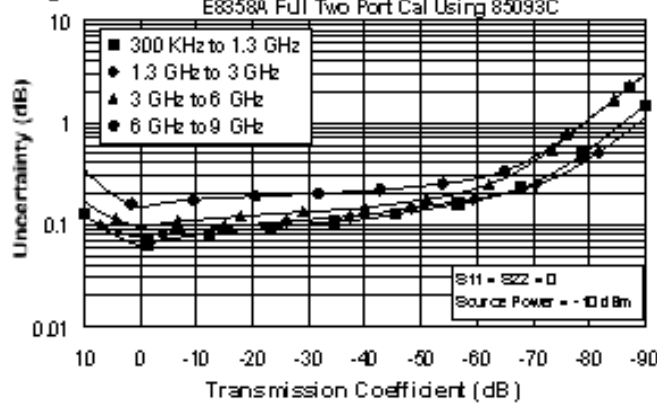

Phase

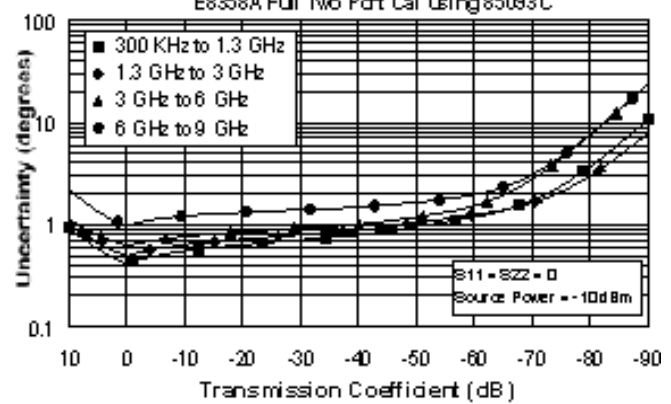

Reflection Uncertainty (Specifications)

Magnitude

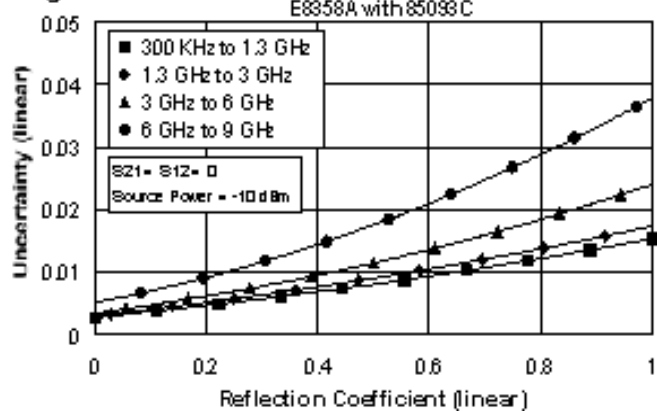

Phase

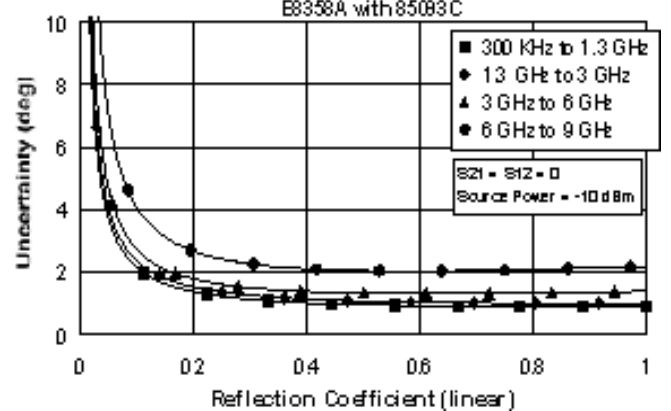

Table 9. Corrected System Performance With 3.5 mm Device Connector Type, Option 015 With 85093C Electronic Calibration Module

Applies to the E8356A, E8357A, and E8358A analyzer with Option 015, 85093C (3.5 mm, 50Ω) electronic calibration (ECal) module, N6314A test port cable, and a full 2-port calibration. Also applies to the following conditions:

- IF bandwidth = 10 Hz
- No averaging applied to data
- Environmental temperature 25° ±5 °C, with < 1 °C deviation from calibration temperature
- Isolation calibration not omitted

Description	Specification (dB)			
	300 kHz to 1.3 GHz	1.3 GHz to 3 GHz	3 to 6 GHz	6 to 9 GHz ^a
Directivity	52	52	51	47
Source Match	44	44	39	34
Load Match	47	47	44	40
Reflection Tracking	±0.030	±0.040	±0.050	±0.070
Transmission Tracking	±0.039	±0.049	±0.068	±0.116

Transmission Uncertainty (Specifications)

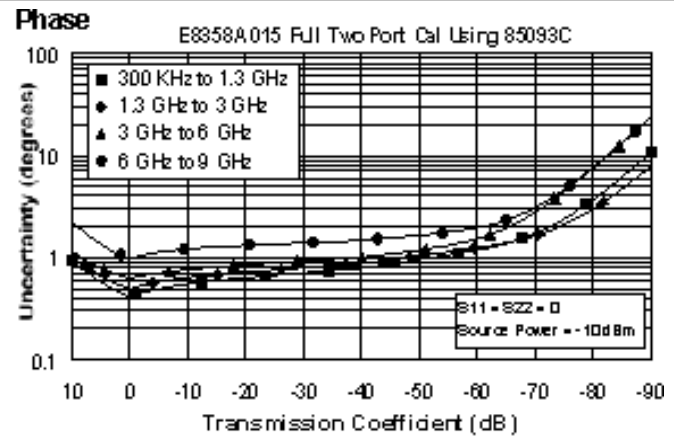
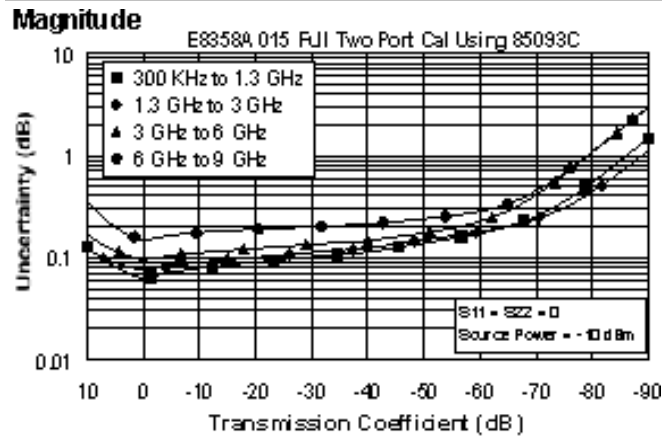

Reflection Uncertainty (Specifications)

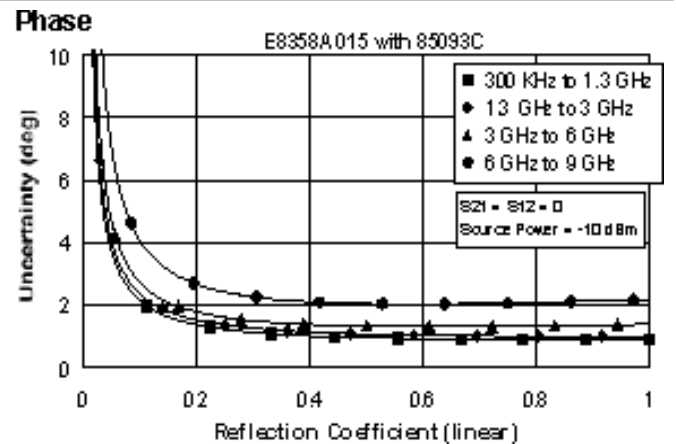
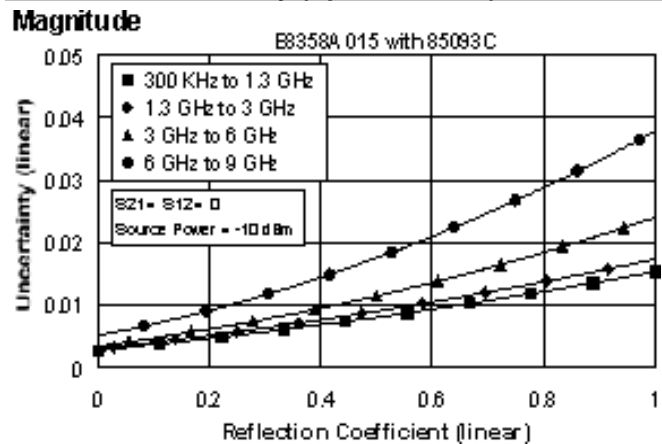

Corrected System Performance with 7-16 Connectors

Table 10. Corrected System Performance With 7-16 Device Connector Type, 85038A Calibration Kit

Applies to the E8356A, E8357A, and E8358A analyzer, 85038A (7-16, 50Ω) calibration kit, N6314A test port cable, and a full 2-port calibration. Also applies to the following conditions:

- IF bandwidth = 10 Hz
- No averaging applied to data
- Environmental temperature 25° ±5 °C, with < 1 °C deviation from calibration temperature
- Isolation calibration not omitted

Description	Specification (dB)			
	300 kHz to 1.3 GHz	1.3 GHz to 3 GHz	3 to 6 GHz	6 to 9 GHza
Directivity	40	40	36	36
Source Match	37	37	34	34
Load Match	39	39	35	35
Reflection Tracking	±0.089	±0.089	±0.115	±0.115
Transmission Tracking	±0.022	±0.031	±0.059	±0.062

Transmission Uncertainty (Specifications)

Magnitude

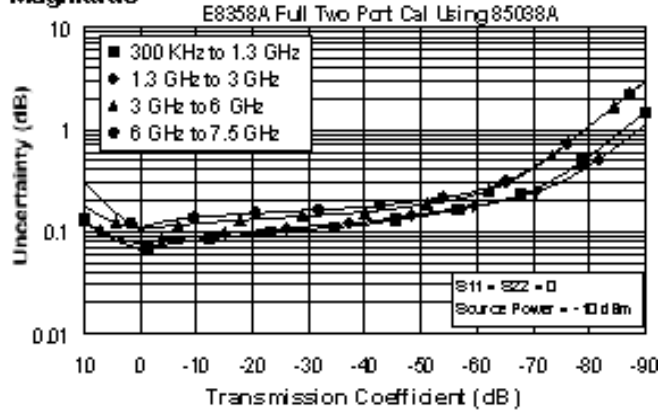

Phase

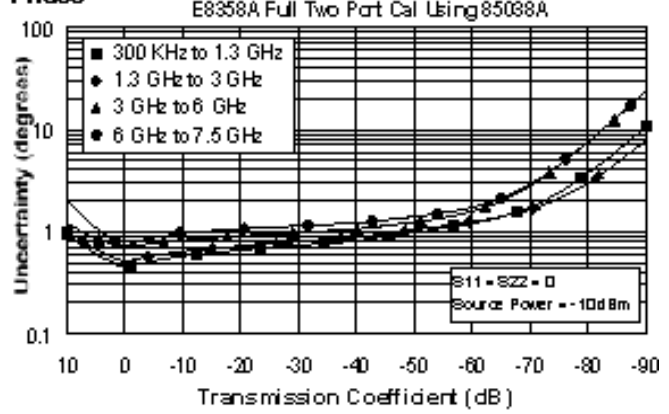

Reflection Uncertainty (Specifications)

Magnitude

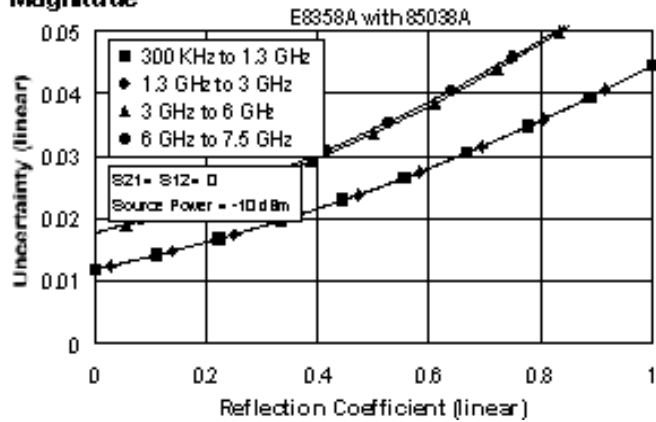

Phase

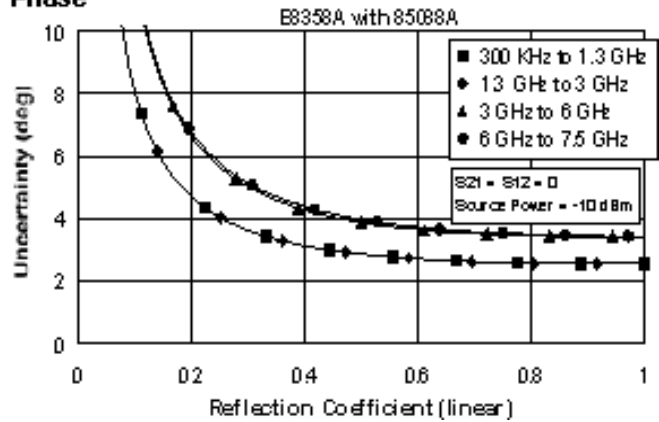

Table 11. Corrected System Performance With 7-16 Device Connector Type, Option 015 With 85038A Calibration Kit

Applies to the E8356A, E8357A, and E8358A analyzer with Option 015, 85038A (7-16, 50Ω) calibration kit, N6314A test port cable, and a full 2-port calibration. Also applies to the following conditions:

- IF bandwidth = 10 Hz
- No averaging applied to data
- Environmental temperature 25° ±5 °C, with < 1 °C deviation from calibration temperature
- Isolation calibration not omitted

Description	Specification (dB)			
	300 kHz to 1.3 GHz	1.3 GHz to 3 GHz	3 to 6 GHz	6 to 9 GHz ^a
Directivity	40	40	36	36
Source Match	37	37	34	34
Load Match	39	39	35	35
Reflection Tracking	±0.089	±0.089	±0.115	±0.115
Transmission Tracking	±0.022	±0.040	±0.075	±0.080

Transmission Uncertainty (Specifications)

Magnitude

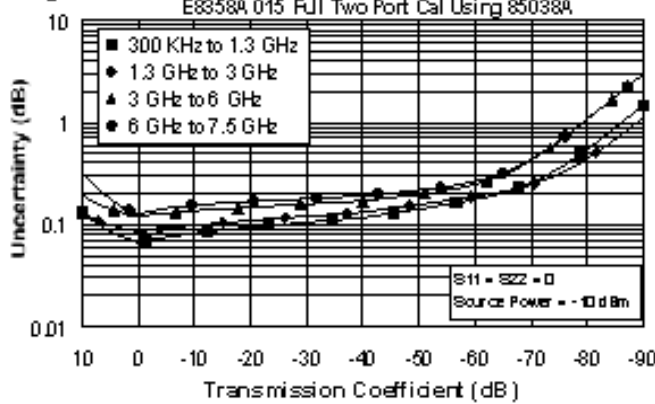

Phase

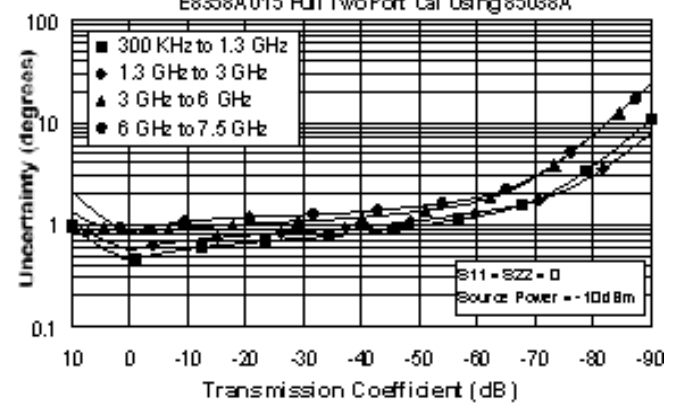

Reflection Uncertainty (Specifications)

Magnitude

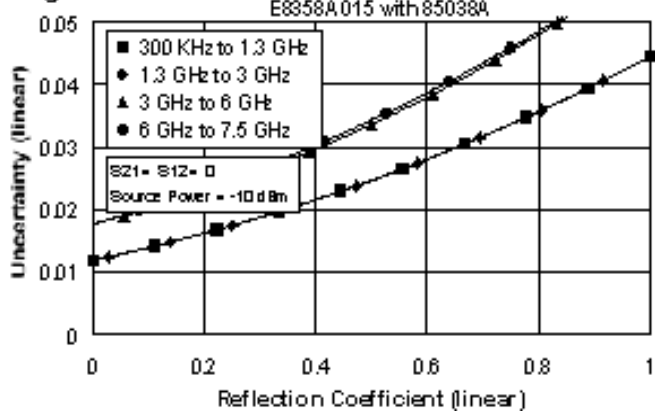

Phase

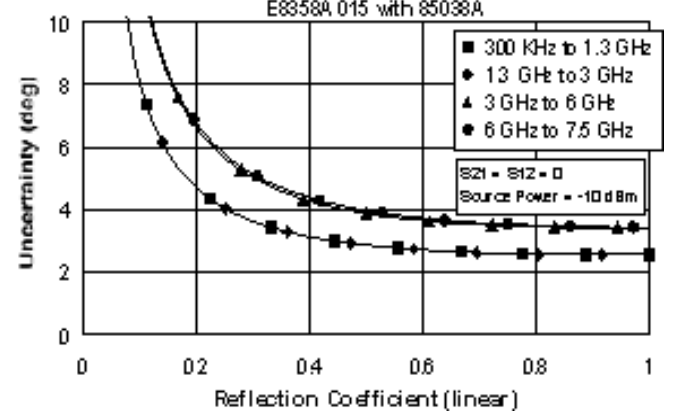

Uncorrected Instrument Performance

Table 12. Uncorrected Instrument Performance

Description	Specification (dB)				
	300 kHz to 1 MHz	1MHz to 1.3 GHz	1.3 GHz to 3 GHz	3 GHz to 6 GHz	6 GHz to 9 GHz
Directivity	30	33	27	20	13
Source Match	20	20	17	15	14
Source Match (Opt. 015)	20	20	15	13	12
Load Match	20	20	17	15	15
Load Match (Opt. 015)	20	20	15	13	13
Reflection Tracking	±1.5	±1.5	±1.5	±2.5	±3.0
Transmission Tracking	±1.5	±1.5	±1.5	±2.5	±3.0

Test Port Output Characteristics (Source)

Table 13. Test Port Output Frequency

Description	Specification	Supplemental Information
Range		
E8356A	300 kHz to 3.0 GHz	
E8357A	300 kHz to 6.0 GHz	
E8358A	300 kHz to 9.0 GHz	
Resolution	1 Hz	
Source Stability		±0.05 ppm, -0° to 40 °C, typical ±0.1 ppm/year, typical
CW Accuracy	±1 ppm	

Table 14. Test Port Output Power^a

Description	Specification	Supplemental Information
Level Accuracy		
		Variation from 0 dBm in power range 0 (step attenuator at 0 dB) ± 1.5 dB below 10 MHz
300 kHz to 10 MHz	± 1.5 dB	
10 MHz to 6 GHz	± 1.0 dB	
6 GHz to 9 GHz	± 2.0 dB	
Level Linearity		
		Variation from 0 dBm in power range 0
300 kHz to 9 GHz	± 0.3 dB	-15 to +5 dBm
300 kHz to 1 MHz	± 1.0 dB	+5 to +10 dBm
1 MHz to 6 GHz	± 0.5 dB	+5 to +10 dBm
Range^b		
300 kHz to 6 GHz	-85 to +10 dBm	
6 GHz to 9 GHz	-85 to +5 dBm	
Sweep Range		
300 kHz to 6 GHz	25 dB	
6 GHz to 9 GHz	20 dB	
Level Resolution	0.01 dB	

^a Source output performance on port 1 only. Port 2 output performance is typical.

^b Power to which the source can be set and phase lock is assured.

Table 15. Test Port Output Signal Purity

Description	Specification	Supplemental Information
Harmonics (2nd or 3rd)		
at max output power (< 25 MHz)		< -25 dBc, typical
at max output power (25 MHz to 9 GHz)		< -25 dBc, characteristic ^a
at 0 dBm output		< -35 dBc, typical
at -10 dBm output		< -38 dBc, typical, in power range 0 (step attenuator at 0 dB)
Non-harmonic Spurious		
at max output		-30 dBc, typical for offset freq >1kHz
at -10 dBm output		-50 dBc, typical for offset freq >1kHz

^a Typical below 25 MHz.

Test Port and Receiver Input Characteristics

Table 16. Test Port and Receiver Input Levels

Description	Specification	Supplemental Information
Maximum Test Port Input Level		
Test Ports 1 and 2:		
300 kHz to 25 MHz	+10 dBm	< 0.6 dB compression
25 MHz to 3 GHz	+10 dBm	< 0.4 dB compression
3 GHz to 6 GHz	+10 dBm	< 0.7 dB compression
6 GHz to 9 GHz	+5 dBm	< 0.7 dB compression
Damage Level		
Test Port 1, 2		+30 dBm or ± 30 VDC, typ.
R1, R2 IN		+15 dBm or ± 5 VDC, typ.
A, B IN (standard)		+15 dBm or ± 5 VDC, typ.
A, B IN (Opt. 015)		+15 dBm or ± 0 VDC, typ.
Coupler IN (Opt. 015)		+33 dBm or ± 0 VDC, typ.
Test Port Noise Floor^a		
300 kHz to 25 MHz ^b		
10 Hz IF Bandwidth	-115 dBm	
1 kHz IF Bandwidth	-95 dBm	
25 MHz to 3 GHz ^b		
10 Hz IF Bandwidth	-118 dBm	
1 kHz IF Bandwidth	-98 dBm	
3 GHz to 9 GHz		
10 Hz IF Bandwidth	≤ -108 dBm	
1 kHz IF Bandwidth	≤ -88 dBm	
Receiver Noise Floor^a		
300 kHz to 25 MHz ^c		
10 Hz IF Bandwidth	≤ -130 dBm	
1 kHz IF Bandwidth	≤ -110 dBm	
25 MHz to 3 GHz ^c		
10 Hz IF Bandwidth	≤ -133 dBm	
1 kHz IF Bandwidth	≤ -113 dBm	
6 GHz to 9 GHz		
10 Hz IF Bandwidth	≤ -123 dBm	
1 kHz IF Bandwidth	≤ -103 dBm	
Crosstalk		
		Between test ports 1 and 2, with short circuits at both ports
300 kHz to 1 MHz	< -120 dB	
1 MHz to 25 MHz	< -125 dB	
25 MHz to 3 GHz	< -128 dB	
3 GHz to 6 GHz	< -118 dB	
6 GHz to 9 GHz	< -113 dB	
Maximum Receiver Input Level (A, B, R1, R2)		
300 kHz to 6 GHz		-6 dBm, typical
6 GHz to 9 GHz		-11 dBm, typical

Description	Specification	Supplemental Information
Reference Input Level (R1, R2)^d		
300 kHz to 9 GHz		-10 to -35 dBm, typical
Maximum Coupler Input Level (Opt 015)		
300 kHz to 9 GHz		+33 dBm, typical

^a Total average (RMS) noise power calculated as the mean value of a linear magnitude trace expressed in dBm.

^b May be limited to -90 dBm at particular frequencies below 750 MHz due to spurious receiver residuals.

^c May be limited to -105 dBm at particular frequencies below 750 MHz due to spurious receiver residuals.

^d Input level to maintain phase lock.

Table 17. Test Port Input (Trace Noise)

Description	Specification	Supplemental Information
Trace Noise^a Magnitude		
1 kHz IF Bandwidth	< 0.002 dB rms	
10 kHz IF Bandwidth	< 0.005 dB rms	
Trace Noise^a Phase		
1 kHz IF Bandwidth	< 0.010° rms	
10 kHz IF Bandwidth	< 0.035° rms	

^a Trace noise is defined as a ratio measurement of a through or a full reflection, with the source set to 0 dBm.

Table 18. Test Port Input (Reference Level and Stability)

Description	Specification	Supplemental Information
Reference Level Magnitude		
Range	±200 dB	
Resolution	0.001 dB	
Reference Level Phase		
Range	±500°	
Resolution	0.01°	
Stability Magnitude^a		
300 kHz to 3 GHz		0.02 dB/°C, typical
3 GHz to 6 GHz		0.04 dB/°C, typical
6 GHz to 9 GHz		0.06 dB/°C, typical
Stability Phase^a		
300 kHz to 3 GHz		0.2°/°C, typical
3 GHz to 6 GHz		0.3°/°C, typical
6 GHz to 9 GHz		0.6°/°C, typical

^a Stability is defined as a ratio measurement at the test port.

Table 19. Test Port Input (Dynamic Accuracy specification^a)

Accuracy of the test port input power reading is relative to the reference input power level. Applies to input ports 1 and 2 with the following conditions:

- IF bandwidth = 10 Hz
- Environmental temperature 25° ±5 °C, with < 1 °C deviation from calibration temperature

300 kHz to 3 GHz

300 kHz to 3 GHz

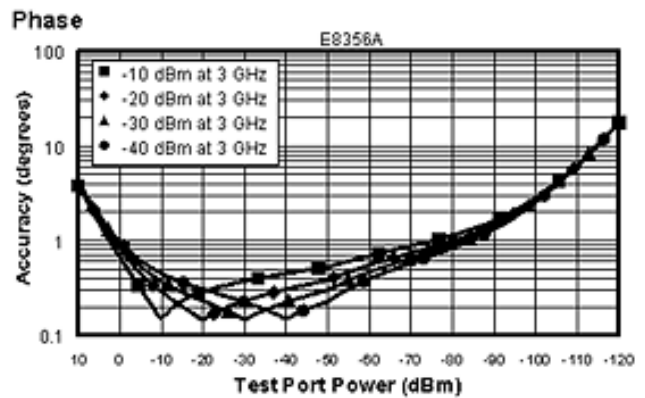
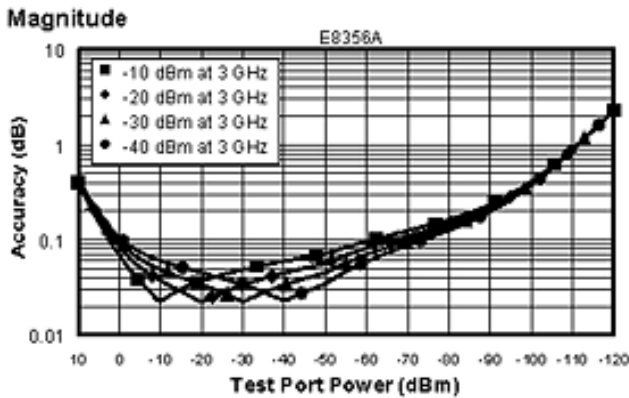

300 kHz to 6 GHz

300 kHz to 6 GHz

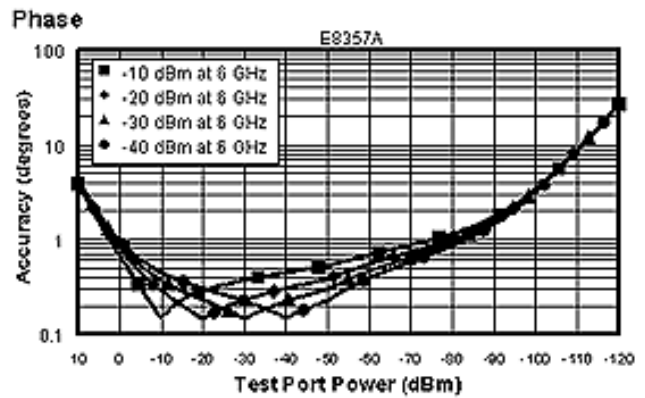
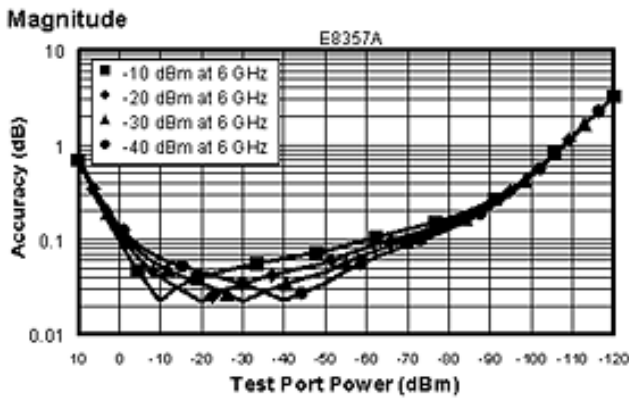

300 kHz to 9 GHz

300 kHz to 9 GHz

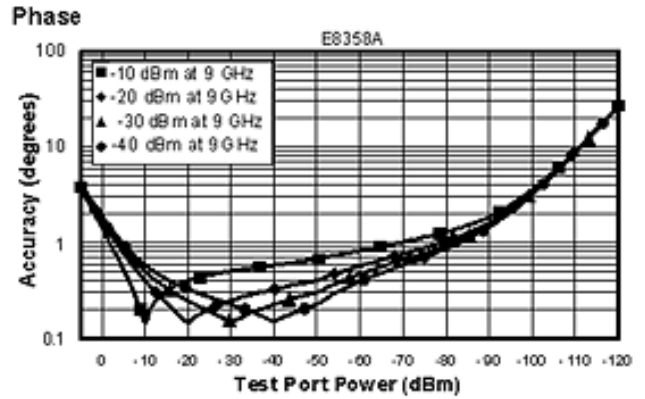
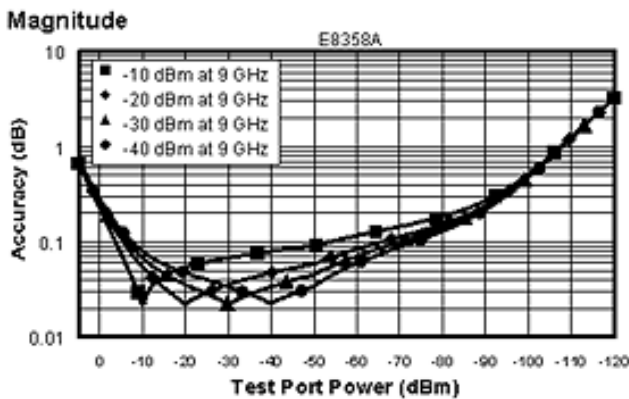

^a Dynamic accuracy is verified with the following measurements: compression over frequency, and IF linearity at a single frequency of 1.195 GHz and a reference level of -20 dBm

Table 20. Test Port Input (Group Delay)^a

Description	Specification	Supplemental Information
Aperture (selectable)	(frequency span)/(number of points -1)	
Maximum Aperture	20% of frequency span	
Range	0.5 x (1/minimum aperture)	
Maximum Delay		Limited to measuring no more than 180° of phase change within the minimum aperture.)
Accuracy		See graph below. Char.

The following graph shows group delay accuracy with type-N full 2-port calibration and a 10 Hz IF bandwidth. Insertion loss is assumed to be < 2 dB and electrical length to be ten meters.

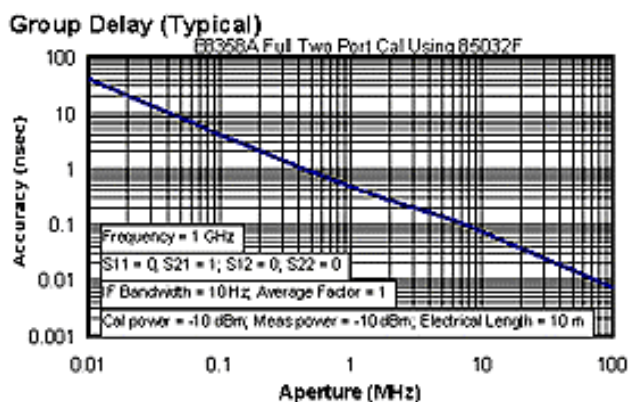

In general, the following formula can be used to determine the accuracy, in seconds, of specific group delay measurement:

$$\pm \text{Phase Accuracy (deg)} / [360 \times \text{Aperture (Hz)}]$$

Depending on the aperture and device length, the phase accuracy used is either incremental phase accuracy or worst case phase accuracy.

^a Group delay is computed by measuring the phase change within a specified frequency step (determined by the frequency span and the number of points per sweep).

General Information

Table 21. System Bandwidths

Description	Specification	Supplemental Information
IF Bandwidth Settings		
Range		1 Hz to 40 kHz in a 1, 2, 3, 5, 7, 10 sequence up to 30 kHz, 35 kHz, 40kHz, nominal

Table 22. Front Panel Information

Description	Supplemental Information
RF Connectors	
Type	Type-N, female; 50 Ω , nominal
Center Pin Protrusion	0.204 to 0.207 in., characteristic
Probe Power	
Connector	3-pin connector, male
Positive Supply	+15 VDC \pm 2%, 400 mA, max, characteristic
Negative Supply	-12.6 VDC \pm 5%, 300 mA, max, characteristic
Display	
Size	21.3 cm (8.4 in) diagonal color active matrix LCD; 640 (horizontal) X 480 (vertical) resolution
Refresh Rate	Vertical 59.83 Hz; Horizontal 31.41 Hz
Display Range	
Magnitude	\pm 200 dB (at 20 dB/div), max
Phase	\pm 180°, max
Polar	10 pUnits, min 1000 Units, max
Display Resolution	
Magnitude	0.001 dB/div, min
Phase	0.01°/div, min
Marker Resolution	
Magnitude	0.001 dB, min
Phase	0.01°, min
Polar	0.01 mUnit, min; 0.01°, min

Table 23. Rear Panel Information

Description	Supplemental Information
Test Port Bias Input	
Connector	BNC, female
Maximum Voltage	±30 VDC, typical
Maximum Current (no degradation in RF specifications)	±200 mA, typical
Maximum Current	±1 A, typical
Bias Input Connectors	
Bias current	500 mA, maximum
Bias voltage	40 Volts, maximum
10 MHz Reference In	
Connector	BNC, female
Input Frequency	10 MHz ± 1 ppm, typical
Input Level	-15 dBm to +20 dBm, typical
Input Impedance	200 Ω, nom.
10 MHz Reference Out	
Connector	BNC, female
Output Frequency	10 MHz ± 1 ppm, typical
Signal Type	Sine Wave, typical
Output Level	+10 dBm ± 4 dB into 50 Ω, typical
Output Impedance	50 Ω, nominal
Harmonics	<-40 dBc, typical
VGA Video Output	
Connector	15-pin mini D-Sub; Drives VGA compatible monitors
Devices Supported:	Resolutions:
Flat Panel (TFT)	1024 X 768, 800 X 600, 640 X 480
Flat Panel (DSTN)	800 X 600, 640 X 480
CRT Monitor	1280 X 1024, 1024 X 768, 800 X 600, 640 X 480
	Simultaneous operation of the internal and external displays is allowed, but with 640 X 480 resolution only. If you change resolution, you can only view the external display (internal display will "white out").
Test Set IO	25-pin D-Sub connector, available for external test set control
Aux IO	25-pin D-Sub connector, male, analog and digital IO
Handler IO	36-pin IDC D-ribbon socket connector; all input/output signals are default set to negative logic; can be reset to positive logic via GPIB command
GPIB	24-pin D-sub (Type D-24), female; compatible with IEEE-488.
Parallel Port (LPT1)	25-pin D-Sub connector, female; provides connection to printers or any other parallel port peripheral
Serial Port (COM 1)	9-pin D-Sub, male; compatible with RS-232
USB Port	
	Universal Serial Bus jack, Type A configuration (4 contacts inline, contact 1 on left); female
Contact 1	Vcc: 4.75 to 5.25 VDC, 500 mA, maximum
Contact 2	-Data
Contact 3	+Data
Contact 4	Ground
LAN	10/100BaseT Ethernet; 8-pin configuration; auto selects between the two data rates

Description	Supplemental Information
Line Power^{a, b}	
Frequency at 110/115 V	50/60/400 Hz
Frequency at 230/240 V	50/60 Hz
Maximum Watts	350 W

^a A third-wire ground is required.

^b Power supply has a voltage autoswitching feature.

Note: Option H08 and Option H11 specifications are not provided in this E8356/7/8A specifications document.

Table 24. Rear Panel Information (continued)

Description	Supplemental Information
External AM Input	
Description	Input provides low-frequency AM modulation to test port output signal, or shifts the test port output. Zero volts input gives the power level set by the instrument, a positive voltage gives a higher level, and a negative voltage gives a lower level.
Connector	BNC, female
Input Sensitivity	8 dB/V, typical
Bandwidth	1 kHz, typical
Input Impedance	1 k Ω , typical
External Detector Input	
Description	Input from an external, negative polarity diode detector provides ALC for a test port remote from instrument's front panel
Connector	BNC, female
Input Sensitivity	-500 mV yields approximately -3 dBm at detector's input, typical
Bandwidth	50 kHz, typical
Input Impedance	1 k Ω , nominal

Table 25. Analyzer Environment and Dimensions

Description		Supplemental Information		
General Environmental				
RFI/EMI Susceptibility		Defined by CISPR Pub. 11, Group 1, Class A, and IEC 50082-1		
ESD		Minimize using static-safe work procedures and an antistatic bench mat		
Dust		Minimize for optimum reliability		
Operating Environment				
Temperature		0 °C to +40 °C Instrument powers up, phase locks, and displays no error messages within this temperature range.		
Error-Corrected Temperature Range		25°C ± 5°C with less than 1°C deviation from calibration temp.		
Humidity		5% to 95% at +40 °C		
Altitude		0 to 4500 m (14,760 ft.)		
Non-Operating Storage Environment				
Temperature		-40 °C to +70 °C		
Humidity		0% to 90% at +65 °C (non-condensing)		
Altitude		0 to 15,240 m (50,000 ft.)		
Cabinet Dimensions				
	Height	Width	Depth	
Excluding front and rear panel hardware and feet	223 mm 8.75 in	426 mm 16.75 in	427 mm 16.8 in	
As shipped - includes front panel connectors, rear panel bumpers, and feet.	235 mm 9.25 in	435 mm 17.10 in	470 mm 18.5 in	
As shipped plus handles	235 mm 9.25 in	458 mm 18 in	501 mm 19.70 in	
As shipped plus rack-mount flanges	235 mm 9.25 in	483 mm 19 in	470 mm 18.5 in	
As shipped plus handles and flanges	235 mm 9.25 in	483 mm 19 in	501 mm 19.70 in	
Weight				
Net	24 kg (54 lb), nominal			
Shipping	32 kg (70 lb), nominal			

Note: "Misc. Information" specifications are not included in this E8356/7/8A document.

Measurement Throughput Summary

Table 26. Typical Cycle Time^{a,b} (ms)

	Number of Points			
	101	201	401	1601
Start 1.8 GHz, Stop 2 GHz, 35 kHz IF bandwidth				
Uncorrected, 1-port cal	9	12	18	54
2-Port cal	22	29	42	117
Start 300 kHz, Stop 3 GHz, 35 kHz IF bandwidth				
Uncorrected, 1-port cal	39	47	56	96
2-Port cal	80	101	121	204
Start 300 kHz, Stop 9 GHz, 35 kHz IF bandwidth				
Uncorrected, 1-port cal	51	57	64	103
2-Port cal	112	124	138	220

^a Typical performance.

^b Includes sweep time, retrace time and band-crossing time. Analyzer display turned off with DISPLAY:ENABLE OFF. Add 21 ms for display on. Data for one trace (S11) measurement.

Table 27. Cycle Time vs. IF Bandwidth^a

Applies to the Preset condition (201 points, correction off) except for the following changes:

- CF = 1 GHz
- Span = 100 MHz
- Display off (add 21 ms for display on)

IF Bandwidth (Hz)	Cycle Time (ms) ^b
40,000	8
35,000	9
30,000	11
20,000	13
10,000	28
7000	36
5000	48
3000	72
1000	196
300	620
100	1875
30	8062
10	17877

^a Typical performance.

^b Cycle time includes sweep and retrace time.

Table 28. Cycle Time vs. Number of Points^a

Applies to the Preset condition (35 kHz IF bandwidth, correction off) except for the following changes:

- CF = 1 GHz
- Span = 100 MHz
- Display off (add 21 ms for display on)

Number of Points	Cycle Time (ms) ^b
3	4
11	4
51	5
101	6
201	9
401	16
801	29
1601	52

^a Typical performance.

^b Cycle time includes sweep and retrace time.

Table 29. Data Transfer Time^a (ms)

	Number of Points			
	51	201	401	1601
SCPI over GPIB				
(program executed on external PC)^b				
32-bit floating point	3	7	12	43
64-bit floating point	4	12	22	84
ASCII	7	64	124	489
SCPI over 100 Mbit/s LAN				
(program executed on external PC)^b				
32-bit floating point	1	1	1	1
64-bit floating point	1	1	1	2
ASCII	5	15	26	96
SCPI (program executed in the analyzer)^d				
32-bit floating point	1	1	2	3
64-bit floating point	1	2	2	4
ASCII	8	29	56	222
COM (program executed in the analyzer)^e				
32-bit floating point	1	1	1	1
Variant type	1	1	2	6
DCOM over 100 Mbit/s LAN				
(program executed on external PC)^f				
32-bit floating point ^g	1	1	1	2
Variant type ^h	1	3	6	19

^a Typical performance of unit with new 500 MHz Pentium III Processor.

^b Measured using a VEE 5.0 program running on a 600 MHz HP Kayak, National Instruments™ GPIB card. Transferred complex S11 data, using "CALC:DATA?SDATA".

^c Measured using a VEE 5.0 program running on a 600 MHz HP Kayak. Transferred complex S11 data, using "CALC:DATA?SDATA". Speed dependent on LAN traffic, if connected to network.

^d Measured using a VEE 5.0 program running inside PNA Series Analyzer. Transferred complex S11 data, using "CALC:DATA?SDATA".

^e Measured using a Visual Basic 6.0 program running inside PNA Series Analyzer. Transferred complex S11 data.

^f Measured using a Visual Basic 6.0 program running on a 600 MHz HP Kayak. Transferred complex S11 data. Speed dependent on LAN traffic, if connected to network.

^g Used IArray Transfer.getComplex method for 32-bit floating point.

^h Used meas.getData method for Variant data type.

Table 30. Recall and Sweep Speed^a

Operations	Number of Window(s)	Number of Trace(s)	Recall Time (ms)
Recall	1	1	49
Recall and Sweep	1	1	59
Recall	1	2	82
Recall and Sweep	1	2	96
Recall	1	4	159
Recall and Sweep	1	4	203
Recall	2	2	93
Recall and Sweep	2	2	115
Recall	3	4	158
Recall and Sweep	3	4	218
Recall	4	4	187
Recall and Sweep	4	4	247
Recall	4	8	340
Recall and Sweep	4	8	507

^a CF= 177 MHz, Span = 200 MHz, 201 points, 35 kHz IF BW

E8356A, E8357A, and E8358A Simplified Test Set Block Diagram

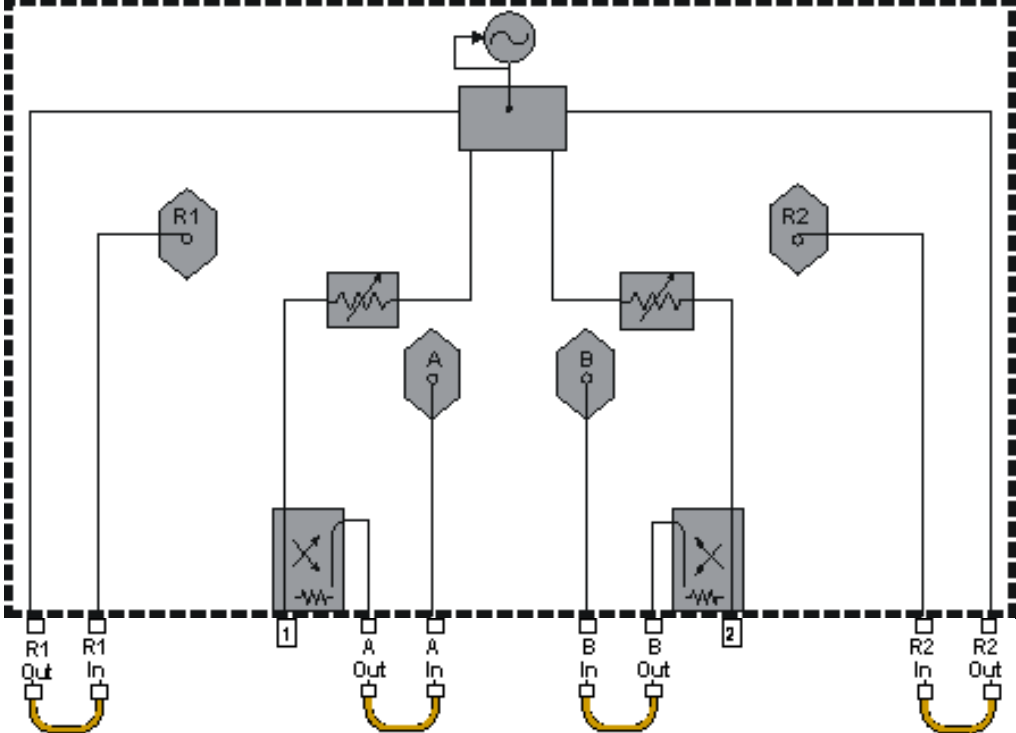

E8356A, E8357A, and E8358A with Option 015 Simplified Test Set Block Diagram

