

Keysight Technologies

4-Port PNA-L Microwave Network Analyzer

N5230C 300 kHz to 13.5, 20 GHz

Data Sheet

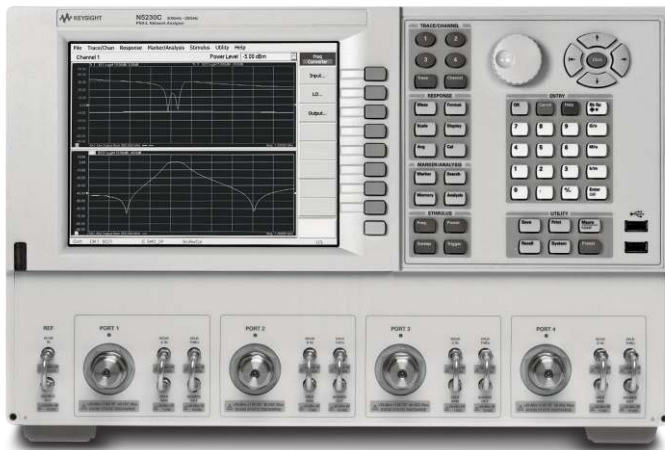

Table of Contents

Definitions	3
Corrected System Performance	4
Table 1. System dynamic range	4
Table 2. Extended dynamic range	5
N5230C Option 140/145/146/240/245/246	
Corrected system performance with 3.5mm connectors	6
Table 3. 85052B Calibration kit N5230C	
Option 140/145/146/240/245/246	6
Table 4. N4433A Electronic calibration module N5230C	
Option 140/145/146/240/245/246	8
Table 5. Uncorrected system performance	10
Table 6. Test port output	11
Table 7: Test port input	13
Table 8. Dynamic accuracy	16
Table 9. Test port input (group delay)	22
General Information	23
Table 10. Miscellaneous information	23
Table 11. Front panel information	23
Table 12. Rear panel information	24
Table 13. Analyzer environment and dimensions	25
Measurement Throughput Summary	26
Table 14. Typical cycle time (ms) for measurement completion	26
Table 15. Cycle time vs IF bandwidth	27
Table 16. Cycle time vs number of points	28
Table 17. Data transfer time (ms)	28
Specifications: Front-Panel Jumpers	29
Table 18: Measurement receiver inputs, 0.1 dB typical compression	29
Table 19: Reference receiver input at max. specified output power	29
Table 20: Reference output at max. specified output power	29
Table 21: Source outputs at max. specified output power	30
Table 22: Coupler inputs, insertion loss of coupler thru	30
Table 23: Coupler outputs	30
Test Set Block Diagrams	31
N5230C Option 140 or 240	
(standard test set and standard power range) network analyzer	31
N5230C Option 145 or 245	
(configurable test set and extended power range) network analyzer	31
N5230C Option 146 or 246	
(configurable test set, extended power range, and internal second	
source) network analyzer	31
Web Resources	32

This is a subset of technical specifications for the N5230C Options 140, 145, 146, 240, 245, and 246 network analyzers.

- Option 140, 300 kHz to 13.5 GHz, 4-port with standard test set and standard power range
- Option 145, 300 kHz to 13.5 GHz, 4-port with configurable test set and extended power range
- Option 146, 300 kHz to 13.5 GHz, 4-port with configurable test set and extended power range with internal second source
- Option 240, 300 kHz to 20 GHz, 4-port with standard test set and standard power range
- Option 245, 300 kHz to 20 GHz, 4-port with configurable test set and extended power range
- Option 246, 300 kHz to 20 GHz, 4-port with configurable test set and extended power range with internal second source

To view or print the N5230C technical specifications, visit our web site at www.keysight.com/find/pnal

This N5230C document provides technical specifications for the following calibration kit and ECal module only: 85052B and N4433A. Please download our free Uncertainty Calculator from www.keysight.com/find/na_calculator to generate the curves for your calibration kit and PNA setup.

Definitions

All specifications and characteristics apply over a 25 °C ±5 °C range (unless otherwise stated) and 90 minutes after the instrument has been turned on.

Specification (spec.): Warranted performance. Specifications include guardbands to account for the expected statistical performance distribution, measurement uncertainties, and changes in performance due to environmental conditions.

Characteristic (char.): A performance parameter that the product is expected to meet before it leaves the factory, but that is not verified in the field and is not covered by the product warranty. A characteristic includes the same guardbands as a specification.

Typical (typ.): Expected performance of an average unit which does not include guardbands. It is not covered by the product warranty.

Nominal (nom.): A general, descriptive term that does not imply a level of performance. It is not covered by the product warranty.

Calibration: The process of measuring known standards to characterize a network analyzer's systematic (repeatable) errors.

Corrected (residual): Indicates performance after error correction (calibration). It is determined by the quality of calibration standards and how well "known" they are, plus system repeatability, stability, and noise.

Uncorrected (raw): Indicates instrument performance without error correction. The uncorrected performance affects the stability of a calibration.

Standard: When referring to the analyzer, this includes no options unless noted otherwise.

Corrected System Performance

The specifications in this section apply for measurements made with the N5230C Options 140, 145, 146, 240, 245, and 246 analyzers with the following conditions:

- 10 Hz IF bandwidth
- No averaging applied to data
- Isolation calibration with an averaging factor of 8

Table 1. System dynamic range at test port¹

Standard configuration and standard power range (Options 140, 240)

Description	Specification (dB) at test port	Typical (dB) at test port
300 kHz to 10 MHz ²		111
10 MHz to 4 GHz ²	120	128
4 to 6 GHz	118	129
6 to 10.5 GHz	115	127
10.5 to 13.5 GHz	107	119
13.5 to 15 GHz	107	119
15 to 20 GHz	103	116

Configurable test set and extended power range (Options 145, 245)

Configurable test set, extended power range, and internal second source (Options 146, 246)

Description	Specification (dB) at test port	Typical (dB) at test port
300 kHz to 10 MHz ²		111
10 MHz to 4 GHz ²	120	128
4 to 6 GHz	118	128
6 to 10.5 GHz	113	125
10.5 to 13.5 GHz	105	117
13.5 to 15 GHz	105	117
15 to 20 GHz	98	115

1. The system dynamic range is calculated as the difference between the noise floor and the specified source maximum output power. The effective dynamic range must take measurement uncertainties and interfering signals into account.
2. May be degraded typically by 10 dB at particular frequencies (multiples of 5 MHz) below 500 MHz due to spurious receiver residuals. Methods are available to regain the full dynamic range.

Table 2. Extended dynamic range¹

Configurable test set and extended power range (Options 145, 245)

Configurable test set, extended power range, and internal second source (Options 146, 246)

Description	Specification (dB) at direct receiver access input	Typical (dB) at direct receiver access input
300 kHz to 10 MHz ²		124
10 MHz to 4 GHz ²	136	
4 to 6 GHz	134	
6 to 10.5 GHz	129	
10.5 to 13.5 GHz	121	
13.5 to 15 GHz	121	
15 to 20 GHz	114	

1. The direct receiver access input extended dynamic range is calculated as the difference between the direct receiver access input noise floor and the source maximum output power. The effective dynamic range must take measurement uncertainties and interfering signals into account. This setup should only be used when the receiver input will never exceed its compression or damage level. When the analyzer is in segment sweep mode, it can have predefined frequency segments which will output a higher power level when the extended dynamic range is required (i.e. devices with high insertion loss), and reduced power when receiver compression or damage may occur (i.e. devices with low insertion loss). The extended range is only available in one-path transmission measurements.
2. May be degraded typically by 10 dB at particular frequencies (multiples of 5 MHz) below 500 MHz due to spurious receiver residuals. Methods are available to regain the full dynamic range.

N5230C Option 140/145/146/240/245/246 Corrected system performance with 3.5 mm connectors¹

Note: For any S_{ii} reflection measurement:
 $S_{ji} = 0$
 For any S_{ij} transmission measurement:
 $S_{ji} = S_{ij}$ when $S_{ij} \leq 1$
 $S_{ji} = 1/S_{ij}$ when $S_{ij} \geq 1$
 $S_{kk} = 0$ for all k

Table 3. 85052B Calibration kit

N5230C

- Option 140 or 240 standard test set and standard power range
- Option 145 or 245 configurable test set and extended power range
- Option 146 or 246 configurable test set and extended power range with internal second source

Applies to the N5230C Option 140/145/146/240/245/246 analyzers, 85052B (3.5mm) calibration kit, 85131F flexible test port cable set, and a full 4-port calibration. Also applies to the following condition: Environmental temperature $23^\circ \pm 3^\circ \text{C}$, with $< 1^\circ \text{C}$ deviation from calibration temperature.

Description	Specification (dB)				
	10 to 500 MHz	500 MHz to 2 GHz	2 to 8 GHz	8 to 13.5 GHz	13.5 to 20 GHz
Directivity	48	48	44	44	44
Source match	40	40	33	31	31
Load match	48	48	44	44	44
Reflection tracking	± 0.003 (+0.01/°C)	± 0.003 (+0.01/°C)	± 0.003 (+0.02/°C)	± 0.006 (+0.03/°C)	± 0.006 (+0.03/°C)
Transmission tracking	± 0.017 (+0.01/°C)	± 0.017 (+0.01/°C)	± 0.062 (+0.02/°C)	± 0.125 (+0.03/°C)	± 0.125 (+0.03/°C)

Transmission uncertainty (specifications)

Magnitude

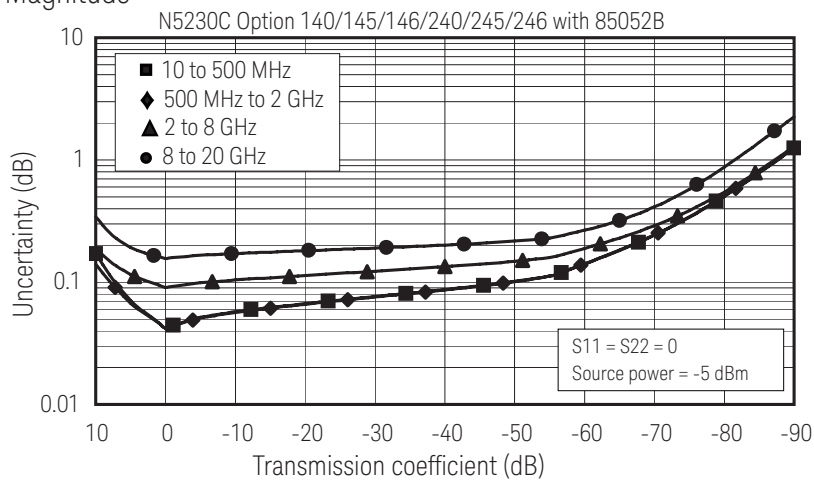

1. From 300 kHz to 10 MHz, performance is characterized as “typical”. To generate these typical values, please download our free Uncertainty Calculator from www.keysight.com/find/na_calculator.

Table 3. 85052B Calibration kit (continued)

N5230C

- Option 140 or 240 standard test set and standard power range
- Option 145 or 245 configurable test set and extended power range
- Option 146 or 246 configurable test set and extended power range with internal second source

Phase

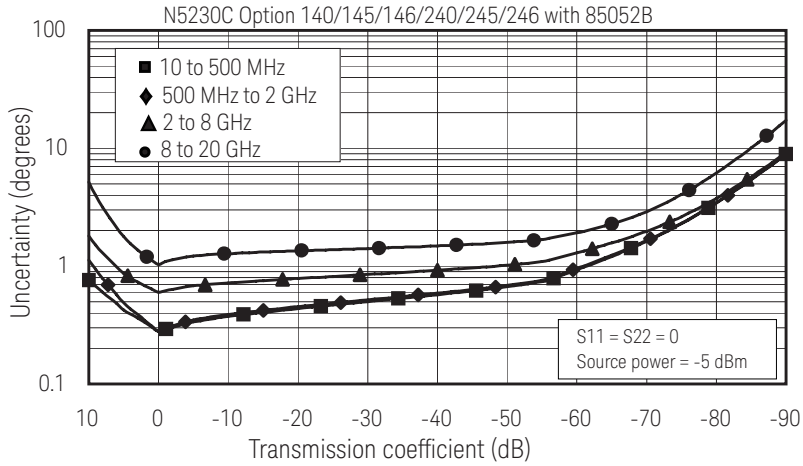

Reflection uncertainty (specifications)

Magnitude

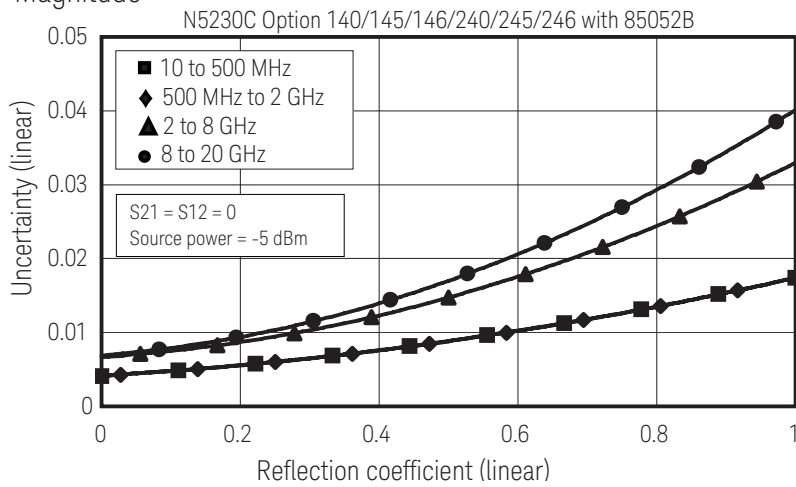

Phase

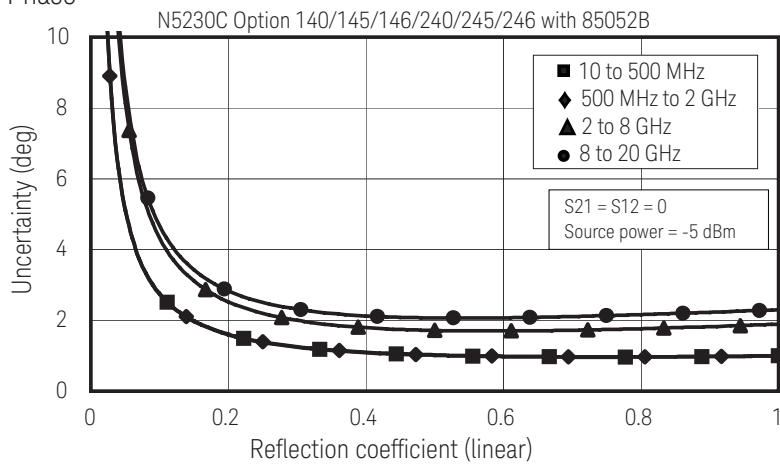

N5230C Option 140/145/146/240/245/246 Corrected system performance with 3.5 mm connectors¹ (continued)

Table 4. N4433A Electronic calibration module

N5230C

- Option 140 or 240 standard test set and standard power range
- Option 145 or 245 configurable test set and extended power range
- Option 146 or 246 configurable test set and extended power range with internal second source

Applies to the N5230C Option 140/145/146/240/245/246 analyzers, N4433A electronic calibration module, 85131F flexible test port cable set, and a full 4-port calibration. Also applies to the following condition: Environmental temperature 23° ±3 °C, with < 1 °C deviation from calibration temperature.

Description	Specification (dB)				
	10 to 500 MHz	500 MHz to 2 GHz	2 to 8 GHz	8 to 13.5 GHz	13.5 to 20 GHz
Directivity	52	52	47	45	45
Source match	42	42	39	31	31
Load match	45	45	41	35	35
Reflection tracking	±0.060 (+0.01/°C)	±0.060 (+0.01/°C)	±0.090 (+0.02/°C)	±0.040 (+0.03/°C)	±0.180 (+0.03/°C)
Transmission tracking	±0.045 (+0.01/°C)	±0.039 (+0.01/°C)	±0.055 (+0.02/°C)	±0.127 (+0.03/°C)	±0.160 (+0.03/°C)

Transmission uncertainty (specifications)

Magnitude

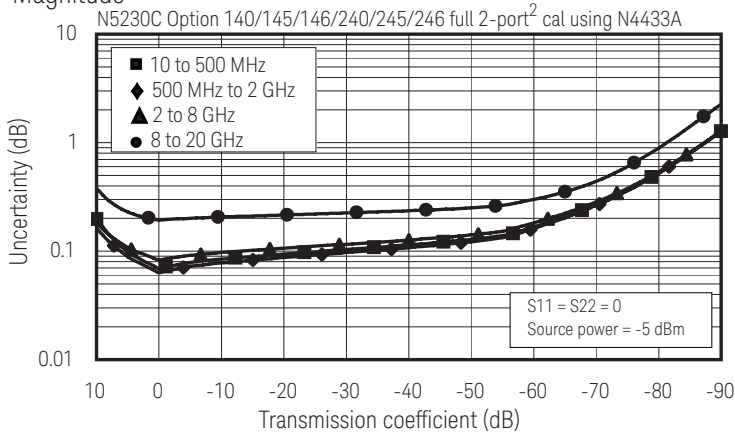

Phase

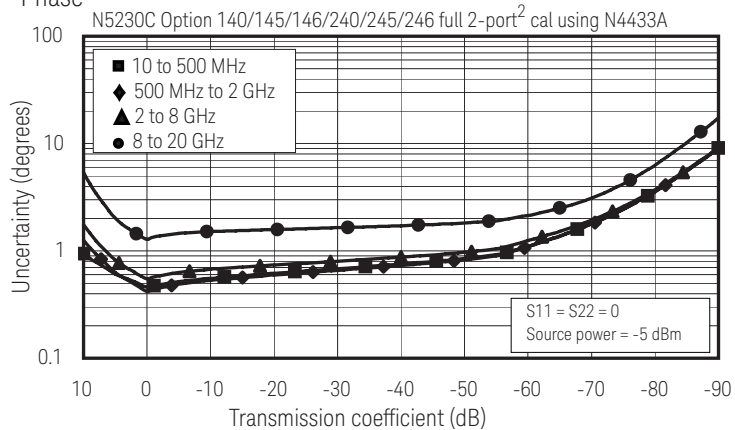

1. From 300 kHz to 10 MHz, performance is characterized as “typical”. To generate these typical values, please download our free Uncertainty Calculator from www.keysight.com/find/na_calculator.
 2. All of the curves are for 2-port calibrations. Multiport uncertainties are currently not supported.

Table 4. N4433A Electronic calibration module (continued)

N5230C

- Option 140 or 240 standard test set and standard power range
- Option 145 or 245 configurable test set and extended power range
- Option 146 or 246 configurable test set and extended power range with internal second source

Reflection uncertainty (specifications)

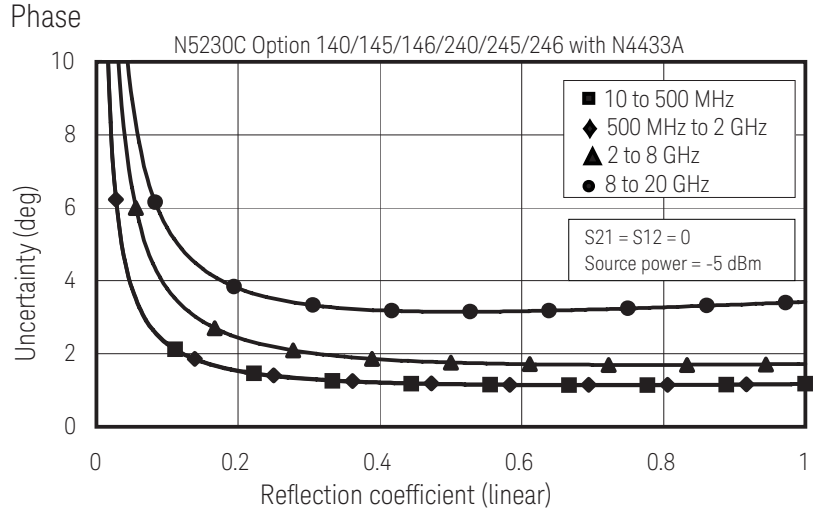
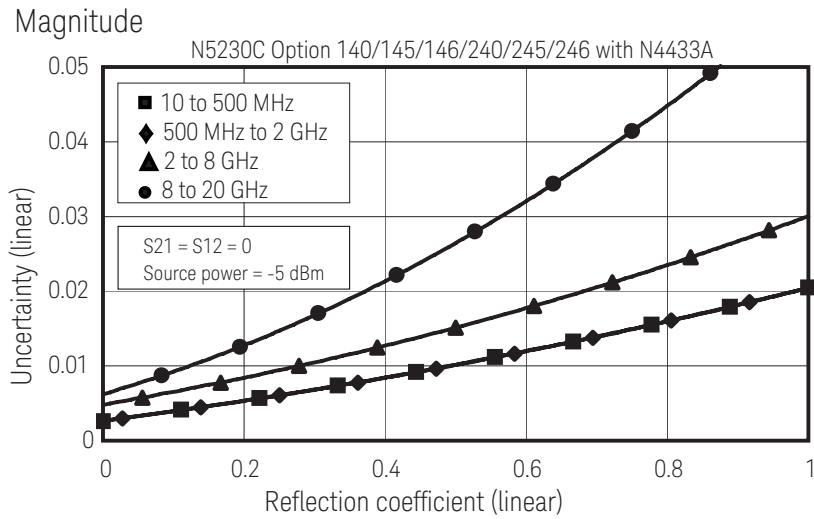

Table 5. Uncorrected system performance¹

Directivity	Specifications Options 140, 145, 146, 240, 245, 246	Typicals Options 140, 145, 240, 245, 246 146,
300 kHz to 10 MHz		-23 dB
10 MHz to 1 GHz	-28 dB	
1 to 3 GHz	-25 dB	
3 to 5 GHz	-20 dB	
5 to 11.5 GHz	-17 dB	
11.5 to 13.5 GHz	-15 dB	
13.5 to 20 GHz	-15 dB	
Source match		
300 kHz to 10 MHz	-8 dB	
10 MHz to 1 GHz	-12 dB	
1 to 3 GHz		-12 dB
3 to 5 GHz		-12 dB
5 to 10.5 GHz	-12 dB	
10.5 to 11.5 GHz	-10 dB	
11.5 to 13.5 GHz	-8 dB	
13.5 to 20 GHz	-8 dB	
Load match		
300 kHz to 10 MHz		-9 dB
10 MHz to 1 GHz	-20 dB	
1 to 3 GHz	-20 dB	
3 to 5 GHz	-18 dB	
5 to 11.5 GHz	-12 dB	
11.5 to 13.5 GHz	-7 dB	
13.5 to 16 GHz	-7 dB	
16 to 20 GHz	-7.5 dB	
Crosstalk²		
300 kHz to 5 MHz	-	-70 dB
5 to 10 MHz	-	-100 dB
10 to 45 MHz	-	-110 dB
45 MHz to 4 GHz	-	-122 dB
4 to 6 GHz	-	-123 dB
6 to 10.5 GHz	-	-120 dB
10.5 to 13.5 GHz	-	-115 dB
13.5 to 15 GHz	-	-115 dB
15 to 20 GHz	-	-110 dB

- Specifications apply over environmental temperature of 25 °C ±5 °C with less than 1 °C variation from calibration temperature.
- Measurement conditions: normalized to a thru, measured with two shorts, 10 Hz IF bandwidth, averaging factor of 8, alternate mode source power set to the lesser of the maximum power out or the maximum receiver power.

Table 6. Test port output¹

Description	Specifications		Typicals	
	Options 140, 240	Options 145, 146, 245, 246	Options 140, 240	Options 145, 146, 245, 246
Frequency range				
Options 140, 145, 146 300 kHz to 13.5 GHz				
Options 240, 245, 246 300 kHz to 20 GHz				
Nominal power				
	-5 dBm	-8 dBm	Preset power; attenuator switch point 10 dB below nominal power	
Frequency resolution				
	1 Hz			
CW accuracy				
	±1 ppm			
Frequency stability				
	-	-	±0.05 ppm. -10° to 70° C	
	-	-	±0.1 ppm/yr maximum	
Description	Specifications		Typicals	
	Options 140, 240	Options 145, 146, 245, 246	Options 140, 240	Options 145, 146, 245, 246
Power level accuracy				
Variation from nominal power in range 0				
300 kHz to 10 MHz				
			±1.0 dB	±1.0 dB
10 MHz to 2 GHz	±1.0 dB	±1.0 dB		
2 to 10.5 GHz	±1.5 dB	±1.5 dB		
10.5 to 13.5 GHz	±2.5 dB	±2.5 dB		
13.5 to 20 GHz	±2.5 dB	±2.5 dB		
Max leveled power				
300 kHz to 10 MHz			+8 dBm	+8 dBm
10 MHz to 4 GHz	+8 dBm	+8 dBm	+12 dBm	+11 dBm
4 to 6 GHz	+6 dBm	+6 dBm	+10 dBm	+9 dBm
6 to 10.5 GHz	+3 dBm	+1 dBm	+8 dBm	+6 dBm
10.5 to 13.5 GHz	0 dBm	-2 dBm	+5 dBm	+3 dBm
13.5 to 15 GHz	0 dBm	-2 dBm	+5 dBm	+3 dBm
15 to 20 GHz	-3 dBm	-8 dBm	+2 dBm	-1 dBm
Power level linearity				
Specified on Port 1 only. Ports 2, 3, 4 performance is Typical. Test is at the nominal power level.				
300 kHz to 10 MHz				
			±2.0 dB	±2.0 dB
10 MHz to 1 GHz	±2.0 dB	±2.0 dB		
1 to 13.5 GHz	±1.5 dB	±1.5 dB		
13.5 to 20 GHz	±1.5 dB	±1.5 dB		
Power sweep range (ALC)				
ALC range starts at maximum-leveled power and decreases by the dB amount specified here.				
300 kHz to 10 MHz				
			35 dB	35 dB
10 MHz to 4 GHz	33 dB	33 dB		
4 to 6 GHz	31 dB	31 dB		
6 to 10.5 GHz	28 dB	26 dB		
10.5 to 13.5 GHz	25 dB	23 dB		
13.5 to 15 GHz	25 dB	23 dB		
15 to 20 GHz	22 dB	17 dB		
Power resolution				
	0.01 dB	0.01 dB		

Table 6. Test port output¹ (Continued)

Description	Typicals		
	Options 140, 240	Options 145, 146, 245, 246	
Power range			
300 kHz to 10 MHz	-27 to +8 dBm	-87 to +8 dBm	
10 to 45 MHz	-27 to +12 dBm	-87 to +11 dBm	
45 MHz to 4 GHz	-27 to +12 dBm	-87 to +11 dBm	
4 to 6 GHz	-27 to +10 dBm	-87 to +9 dBm	
6 to 10.5 GHz	-27 to +8 dBm	-87 to +6 dBm	
10.5 to 13.5 GHz	-27 to +5 dBm	-87 to +3 dBm	
13.5 to 15 GHz	-27 to +5 dBm	-87 to +3 dBm	
15 to 20 GHz	-27 to +2 dBm	-87 to -1 dBm	
Power settings			
Minimum power setting	-30 dBm	-90 dBm	
Maximum power setting	+20 dBm	+20 dBm	
Harmonics (2nd or 3rd) at maximum output power²			
In-band source harmonics			
300 kHz to 10 MHz	-17 dBc		
10 MHz to 1 GHz	-17 dBc		
1 to 13.5 GHz	-20 dBc		
13.5 to 20 GHz	-20 dBc		
Non-harmonic spurious (at nominal output power²)			
300 kHz to 20 GHz	-50 dBc for offset frequency > 1 kHz		
Typical performance			
Phase noise (Nominal power at test port)			
	10 kHz Offset	100 kHz Offset	1 MHz Offset
300 kHz to 10 MHz	-86 dBc/Hz	-86 dBc/Hz	-95 dBc/Hz
10 MHz to 1.5 GHz	-86 dBc/Hz	-91 dBc/Hz	-95 dBc/Hz
1.5 to 3.125 GHz	-83 dBc/Hz	-91 dBc/Hz	-95 dBc/Hz
3.125 to 6.25 GHz	-77 dBc/Hz	-85 dBc/Hz	-89 dBc/Hz
6.25 to 12.5 GHz	-71 dBc/Hz	-79 dBc/Hz	-83 dBc/Hz
12.5 to 13.5 GHz	-65 dBc/Hz	-73 dBc/Hz	-77 dBc/Hz
13.5 to 20 GHz	-65 dBc/Hz	-73 dBc/Hz	-77 dBc/Hz

- For Options 140/145/240/245, performance specified on Port 1 only; Ports 2, 3, and 4 performance is typical. For Options 146/246, performance is specified on Ports 1 and 3 only; Ports 2 and 4 performance is typical.
- Spurious signal levels are valid for a 10 MHz span centered on the carrier frequency. Spurious signals up to -15 dBc may exist outside the span. These signals do not affect the accuracy of the network analyzer measurements.

Table 7: Test port input

Description	Specification		Typicals	
	Options 140, 145, 146, 240, 245, 246		Options 140, 145, 146, 240, 245, 246	
Test port noise floor				
Total average (rms) noise power calculated as the mean value of a linear magnitude trace expressed in dBm.				
10 Hz IF bandwidth				
300 kHz to 10 MHz				< -103 dBm
10 to 500 MHz	< -112 dBm			< -116 dBm
500 MHz to 4 GHz	< -112 dBm			< -120 dBm
4 to 10.5 GHz	< -112 dBm			< -119 dBm
10.5 to 13.5 GHz	< -107 dBm			< -114 dBm
13.5 to 15 GHz	< -107 dBm			< -114 dBm
15 to 20 GHz	< -106 dBm			< -114 dBm
1 KHz IF bandwidth				
300 kHz to 10 MHz				< -83 dBm
10 to 500 MHz	< -92 dBm			< -96 dBm
500 MHz to 4 GHz	< -92 dBm			< -100 dBm
4 to 10.5 GHz	< -92 dBm			< -99 dBm
10.5 to 13.5 GHz	< -87 dBm			< -94 dBm
13.5 to 15 GHz	< -87 dBm			< -94 dBm
15 to 20 GHz	< -86 dBm			< -94 dBm
Direct receiver access input noise floor (Options 145, 146, 245, 246)				
Total average (rms) noise power calculated as the mean value of a linear magnitude trace expressed in dBm.				
10 Hz IF bandwidth				
300 kHz to 10 MHz				< -119 dBm
10 to 500 MHz	< -128 dBm			< -132 dBm
500 MHz to 4 GHz	< -128 dBm			< -136 dBm
4 to 10.5 GHz	< -128 dBm			< -135 dBm
10.5 to 13.5 GHz	< -123 dBm			< -130 dBm
13.5 to 15 GHz	< -123 dBm			< -130 dBm
15 to 20 GHz	< -122 dBm			< -130 dBm
1 KHz IF bandwidth				
300 kHz to 10 MHz				< -99 dBm
10 to 500 MHz	< -108 dBm			< -112 dBm
500 MHz to 4 GHz	< -108 dBm			< -116 dBm
4 to 10.5 GHz	< -108 dBm			< -115 dBm
10.5 to 13.5 GHz	< -103 dBm			< -110 dBm
13.5 to 15 GHz	< -103 dBm			< -110 dBm
15 to 20 GHz	< -102 dBm			< -110 dBm

Description	Specification		Typicals	
	Options 140, 145, 146, 240, 245, 246		Options 140, 145, 146, 240, 245, 246	
Compression level (at +8 dBm except as noted)				
	Power	Compression	Power	Compression
300 kHz to 10 MHz			+5 dBm	0.10 dB
10 to 50 MHz	+8 dBm	0.35 dB		
50 MHz to 1 GHz	+8 dBm	0.35 dB		
1 to 8 GHz	+8 dBm	0.25 dB		
8 to 12.5 GHz	+8 dBm	0.30 dB		
12.5 to 13.5 GHz	+8 dBm	0.55 dB		
13.5 to 20 GHz	+8 dBm	0.55 dB		
Test port compression at 0.1 dB				
300 kHz to 10 MHz	-	-	+5 dBm	
10 MHz to 1 GHz	-	-	+9 dBm	
1 to 12.5 GHz	-	-	+10 dBm	
12.5 to 13.5 GHz	-	-	+9 dBm	
13.5 to 20 GHz	-	-	+9 dBm	

Table 7. Test port input (Continued)

Description	Specifications			Typicals		
	Options 140, 240	Options 145, 245	Options 146, 246	Options 140, 240	Options 145, 245	Options 146, 246
Trace noise magnitude						
Ratioed measurement, nominal power at test port.						
100 kHz IF bandwidth						
300 kHz to 10 MHz				0.015 dB rms	0.030 dB rms	0.050 dB rms
10 MHz to 10.5 GHz	0.006 dB rms	0.008 dB rms	0.016 dB rms	0.004 dB rms	0.005 dB rms	0.013 dB rms
10.5 to 13.5 GHz	0.010 dB rms	0.014 dB rms	0.038 dB rms	0.007 dB rms	0.009 dB rms	0.026 dB rms
13.5 to 20 GHz	0.010 dB rms	0.014 dB rms	0.038 dB rms	0.007 dB rms	0.009 dB rms	0.026 dB rms
600 kHz IF bandwidth						
300 kHz to 10 MHz		–		0.015 dB rms	0.030 dB rms	0.050 dB rms
10 MHz to 10.5 GHz		–		0.013 dB rms	0.015 dB rms	0.032 dB rms
10.5 to 13.5 GHz		–		0.017 dB rms	0.023 dB rms	0.063 dB rms
13.5 to 20 GHz		–		0.017 dB rms	0.023 dB rms	0.063 dB rms
100 kHz IF bandwidth						
Measured at maximum specified power						
300 kHz to 10 MHz		–		0.005 dB rms	0.010 dB rms	0.012 dB rms
10 MHz to 2 GHz		–		0.001 dB rms	0.003 dB rms	0.004 dB rms
2 to 10.5 GHz		–		0.002 dB rms	0.003 dB rms	0.004 dB rms
10.5 to 13.5 GHz		–		0.006 dB rms	0.009 dB rms	0.023 dB rms
13.5 to 20 GHz		–		0.006 dB rms	0.009 dB rms	0.023 dB rms
Trace noise phase						
Ratioed measurement, nominal power at test port.						
100 kHz IF bandwidth						
300 kHz to 10 MHz				0.110° rms	0.180° rms	0.280° rms
10 MHz to 10.5 GHz	0.05° rms	0.07° rms	0.130° rms	0.025° rms	0.035° rms	0.090° rms
10.5 to 13.5 GHz	0.08° rms	0.10° rms	0.250° rms	0.050° rms	0.060° rms	0.170° rms
13.5 to 20 GHz	0.08° rms	0.10° rms	0.250° rms	0.050° rms	0.060° rms	0.170° rms
600 kHz IF bandwidth						
300 kHz to 10 MHz		–		0.110° rms	0.180° rms	0.300° rms
10 MHz to 10.5 GHz		–		0.080° rms	0.100° rms	0.200° rms
10.5 to 13.5 GHz		–		0.120° rms	0.160° rms	0.430° rms
13.5 to 20 GHz		–		0.120° rms	0.160° rms	0.430° rms
100 kHz IF bandwidth						
Measured at maximum specified power						
300 kHz to 10 MHz		–		0.040° rms	0.050° rms	0.075° rms
10 MHz to 2 GHz		–		0.007° rms	0.012° rms	0.013° rms
2 to 10.5 GHz		–		0.012° rms	0.015° rms	0.030° rms
10.5 to 13.5 GHz		–		0.040° rms	0.060° rms	0.150° rms
13.5 to 20 GHz		–		0.040° rms	0.060° rms	0.150° rms
Stability magnitude						
Stability as defined as a ratio measurement made at the test port.						
300 kHz to 10 MHz		–		±0.015 dB/°C		±0.015 dB/°C
10 MHz to 2 GHz		–		±0.010 dB/°C		±0.010 dB/°C
2 to 4 GHz		–		±0.015 dB/°C		±0.015 dB/°C
4 to 13.5 GHz		–		±0.020 dB/°C		±0.020 dB/°C
13.5 to 16 GHz		–		±0.020 dB/°C		±0.020 dB/°C
16 to 19 GHz		–		±0.025 dB/°C		±0.025 dB/°C
19 to 20 GHz		–		±0.030 dB/°C		±0.030 dB/°C

Table 7. Test port input (Continued)

Description	Specifications			Typicals		
	Options 140, 240	Options 145, 245	Options 146, 246	Options 140, 240	Options 145, 245	Options 146, 246
Stability phase						
Stability as defined as a ratio measurement made at the test port.						
300 kHz to 10 MHz		-		±0.360°/°C		±0.360°/°C
10 to 45 MHz		-		±0.020°/°C		±0.020°/°C
45 to 500 MHz		-		±0.030°/°C		±0.030°/°C
500 MHz to 2 GHz		-		±0.050°/°C		±0.070°/°C
2 to 4 GHz		-		±0.100°/°C		±0.150°/°C
4 to 8 GHz		-		±0.150°/°C		±0.250°/°C
8 to 13.5 GHz		-		±0.300°/°C		±0.500°/°C
13.5 to 16 GHz		-		±0.300°/°C		±0.500°/°C
16 to 20 GHz		-		±0.350°/°C		±0.650°/°C
Reference level magnitude						
Range	±200 dB	±200 dB	±200 dB			
Resolution	.001 dB	.001 dB	.001 dB			
Reference level phase						
Range	±500°	±500°	±500°			
Resolution	.01°	.01°	.01°			
Damage input level						
Test port 1, 2, 3, and 4		-		+27 dBm or ±16 VDC		+27 dBm or ±16 VDC
Receivers R, A, B, C, D		-				+15 dBm or ±16 VDC
Source out (reference)		-				+27 dBm or ±16 VDC
Source out (test ports)		-				+27 dBm or ±16 VDC
Coupler thru		-				+27 dBm or ±16 VDC
Coupler arm		-				+15 dBm or ±0 VDC

Table 8. Dynamic Accuracy (specification)

Accuracy of the test port input power reading relative to the reference input power level.

Dynamic accuracy is verified with the following measurements:

- Compression over frequency
- IF linearity at a single frequency of 1.195 GHz using a reference level of -20 dBm for an input power range of 0 to -110 dBm

Dynamic Accuracy 0.045 GHz

Magnitude

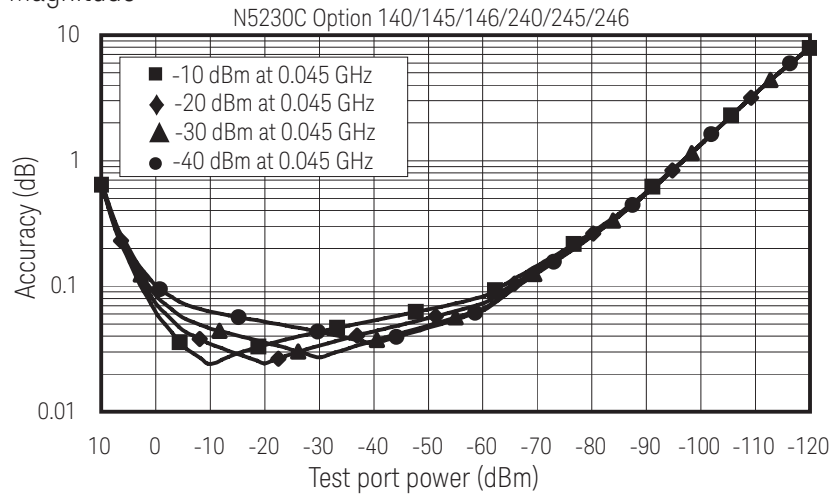

Phase

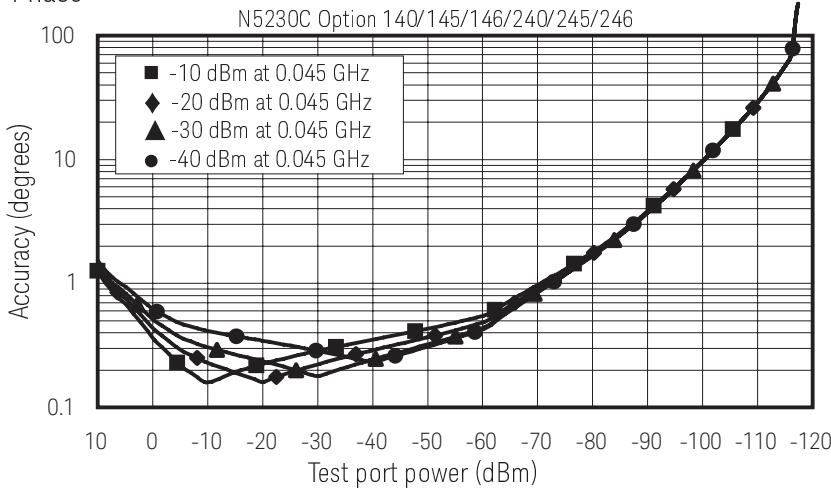
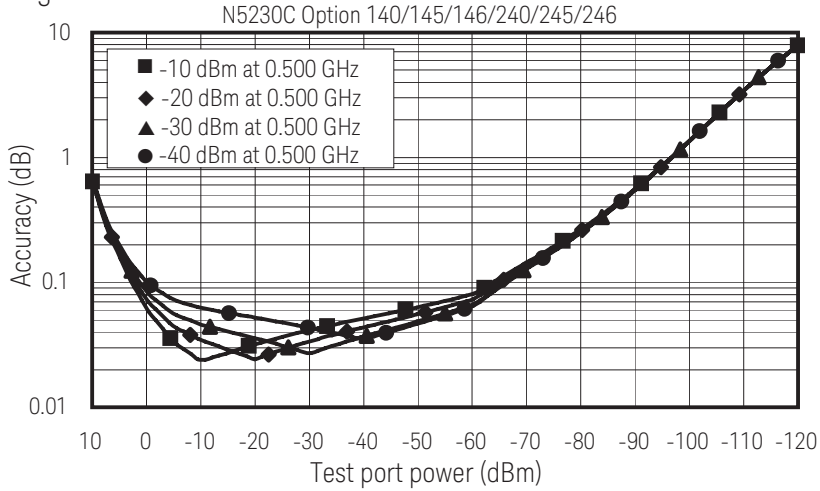

Table 8. Dynamic Accuracy (continued)

Dynamic Accuracy 0.500 GHz

Magnitude



Phase

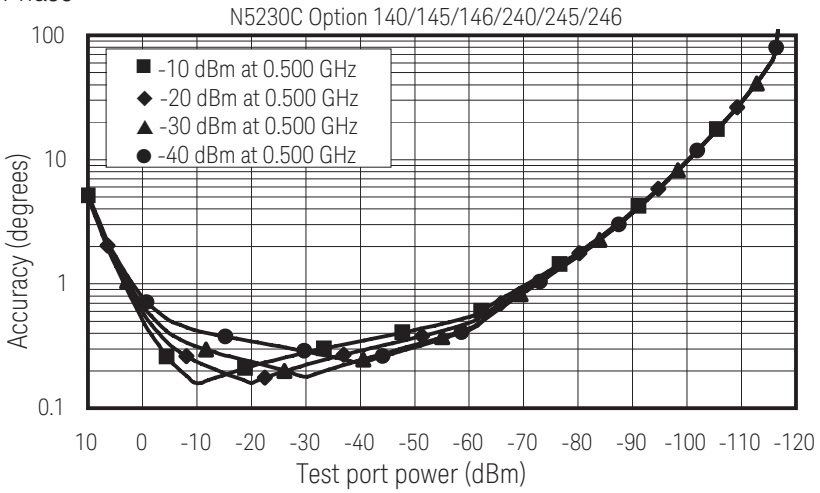
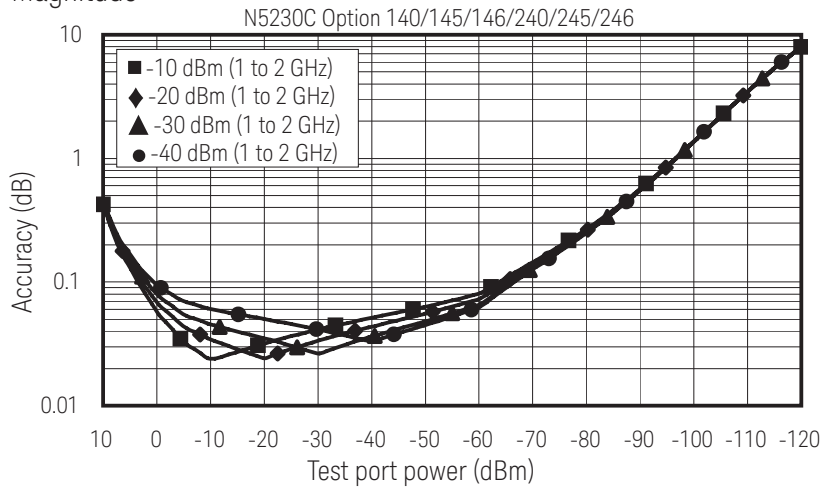

Table 8. Dynamic Accuracy (continued)

Dynamic Accuracy 1 to 2 GHz

Magnitude



Phase

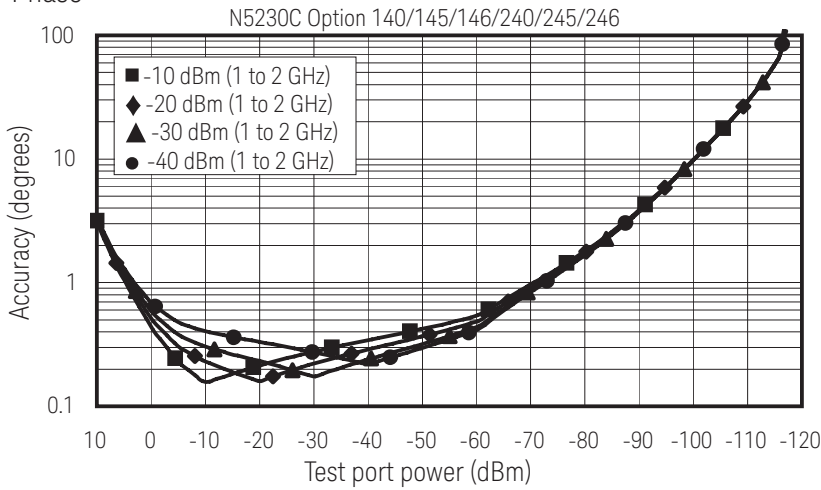
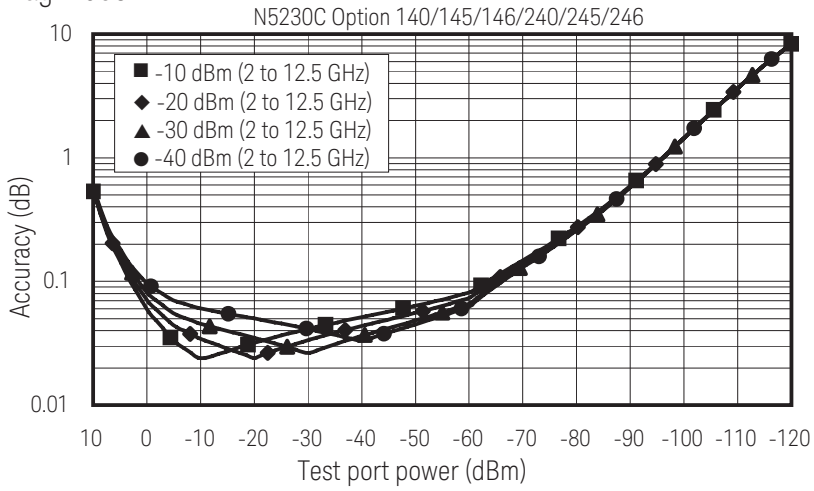

Table 8. Dynamic Accuracy (continued)

Dynamic Accuracy 2 to 12.5 GHz

Magnitude



Phase

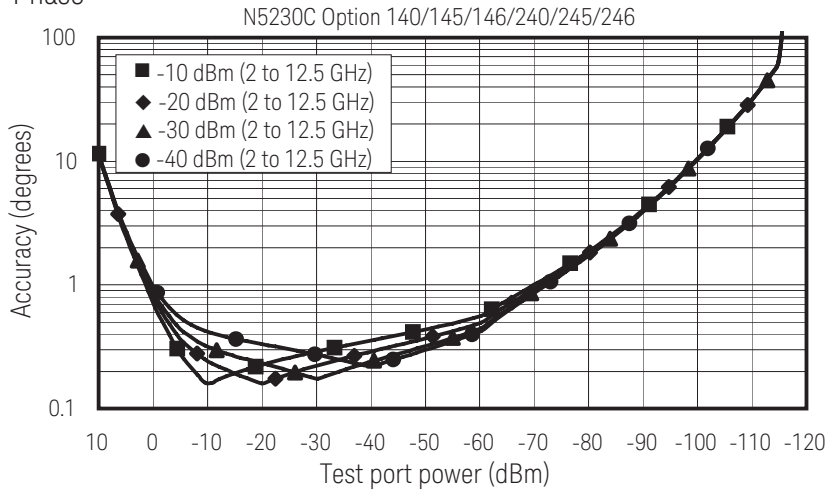
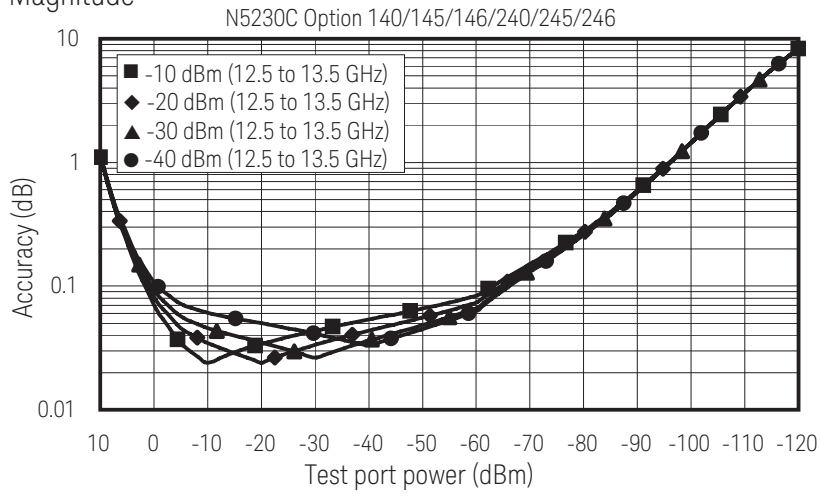

Table 8. Dynamic Accuracy (continued)

Dynamic Accuracy 12.5 to 13.5 GHz

Magnitude



Phase

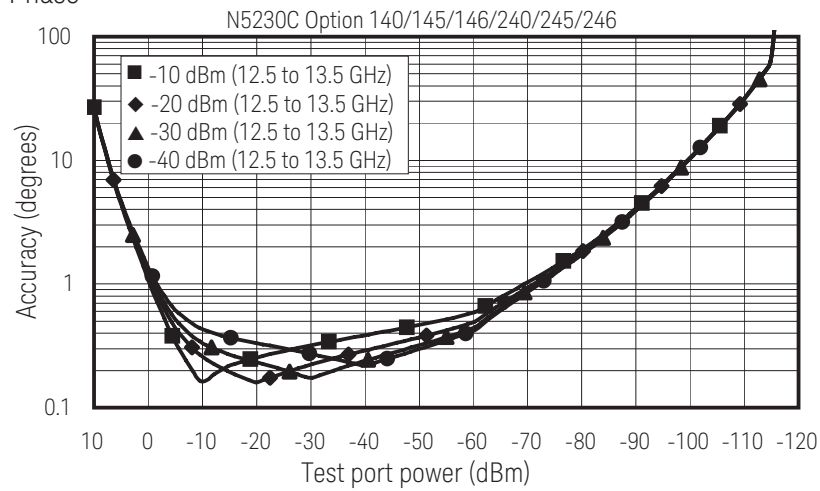
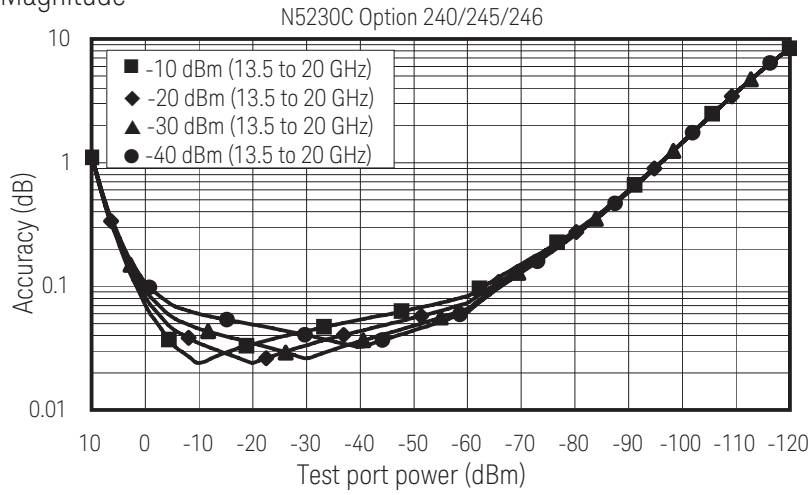

Table 8. Dynamic Accuracy (continued)

Dynamic Accuracy 13.5 to 20 GHz

Magnitude



Phase

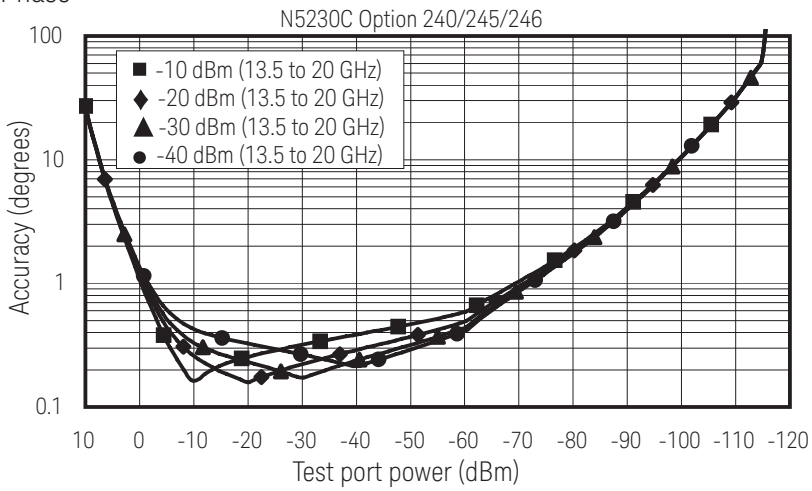

Table 9. Test port input (group delay)

Description	Supplemental information (typ.)
Aperture (selectable)	(frequency span)/(number of points -1)
Maximum aperture	20% of frequency span
Range	0.5 x (1/minimum aperture)
Maximum delay	Limited to measuring no more than 180° of phase change within the minimum aperture
Accuracy	See graph below. (Char.)

The following graph shows characteristic group delay accuracy with full 2-port calibration and a 10 Hz IF bandwidth. Insertion loss is assumed to be < 2 dB and electrical length to be ten meters.

For any S_{ij} group delay measurement, $S_{ii} = \dots$ for all k

Group delay (typical)

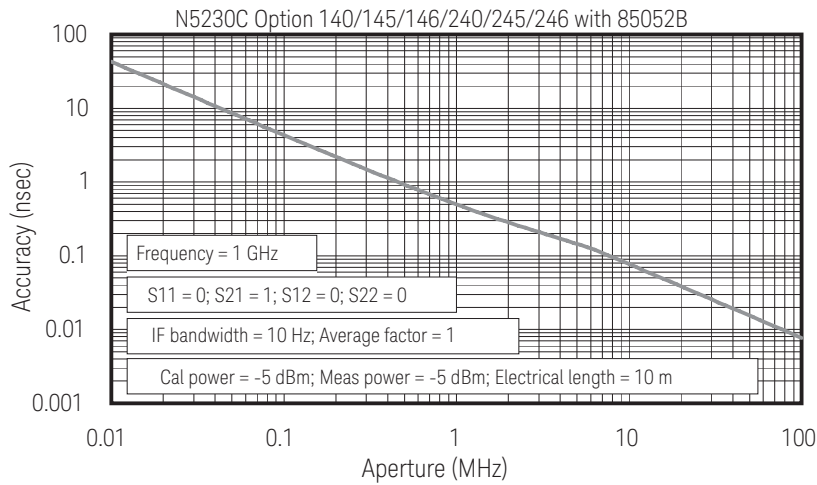

In general, the following formula can be used to determine the accuracy, in seconds, of specific group delay measurement:

$$\pm \text{Phase Accuracy (deg)} / [360^\circ \text{ Aperture (Hz)}]$$

Depending on the aperture and device length, the phase accuracy used is either incremental phase accuracy or worst case phase accuracy.

General Information

Table 10. Miscellaneous information

Description	Supplemental information
System IF bandwidth range	1 Hz to 600 kHz, nominal
CPU	Intel 1.1 GHz Pentium M with 1 GByte RAM

Table 11. Front panel information

Description	Supplemental information
RF connectors	
Type	Options 140, 145, 146, 240, 245, 246: 3.5 mm (male), 50 ohm (nominal)
Center pin recession	0.002 in. (characteristic)
Display	
Size	21.3 cm (8.4 in) diagonal color active matrix LCD; 1024 (horizontal) X 768 (vertical) resolution A display is considered faulty if: <ul style="list-style-type: none"> - A complete row or column of "stuck" or "dark" pixels. - More than six "stuck on" pixels (but not more than three green) or more than 0.002% of the total pixels are within the LCD specifications. - More than twelve "dark" pixels (but no more than seven of the same color) or more than 0.004% of the total pixels are within the LCD specifications. - Two or more consecutive "stuck on" pixels or three or more consecutive "dark" pixel (but no more than one set of two consecutive dark pixels) "Stuck on" of "dark" pixels less than 6.5 mm apart (excluding consecutive pixels)
Refresh rate	60 Hz
Display range	
Magnitude	±500 dB (at 20 dB/div), max
Phase	±500°, max
Polar	10 pUnits, min 1000 Units, max
Display resolution	
Magnitude	0.001 dB/div, min
Phase	0.01°/div, min
Marker resolution	
Magnitude	0.001 dB, min
Phase	0.01°, min
Polar	0.01 mUnit, min; 0.01°,min

Table 12. Rear panel information

Description	Supplemental information
Trigger inputs/outputs	BNC (f), TTL/CMOS compatible
10 MHz Reference in	
Connector	BNC, female
Input frequency	10 MHz \pm 10 ppm, typical
Input level	-15 to +20 dBm, typical
Input impedance	200 Ω , nom.
10 MHz Reference out	
Connector	BNC, female
Output frequency	10 MHz \pm 1 ppm, typical
Signal type	Sine Wave, typical
Output level	+10 dBm \pm 4 dB into 50 Ω , typical
Output impedance	50 Ω , nominal
Harmonics	< -40 dBc, typical
VGA Video output	
Connector	15-pin mini D-Sub; Drives VGA compatible monitors
Test set IO	
	25-pin D-Sub connector, female, available for external test set control
Aux IO	
	25-pin D-Sub connector, male, analog and digital I/O
Handler IO	
	36-pin parallel I/O port; all input/output signals are default set to negative logic; can be reset to positive logic via GPIB command
GPIB	
	Two ports: dedicated controller and dedicated talker/listener
	24-pin D-sub (Type D-24), female; compatible with IEEE-488.
USB Port	
	1 port on front panel and 4 ports on rear panel.
LAN	
	10/100BaseT Ethernet, 8-pin configuration; auto selects between the two data rates
Line power (single phase)	
Frequency, voltage	50/60 Hz/400 Hz for 100-120 V, 50/60 Hz for 220-240 V, power supply is auto switching
Maximum	350 Watts

Note: Option H08 and Option H11 specifications are not provided in this N5230C specifications document.

Table 13. Analyzer environment and dimensions

Description	Supplemental information		
General environmental			
E	Complies with European EMC directive 2004/108/EC <ul style="list-style-type: none"> - IEC/EN 61326-1:2005 - CISPR Pub 11 Group 1, class A - AS/NZS CISPR11:2004 - ICES/NMB-001 		
Safety	<ul style="list-style-type: none"> - Complies with European Low Voltage Directive 2006/95/EC - IEC/EN 61010-1:2001 - Canada: CSA C22.2 No. 61010-1:2004 - USA: UL 61010-1:2004 		
Operating environment			
Temperature	0 to +40 °C		
	Instrument powers up and displays no error messages within this temperature range (except for "source unlevelled" error message that may occur at temperatures outside the specified performance temperature range of 25 ± 5 °C).		
Error-corrected temperature range	23 °C ± 3 °C with less than 1 °C deviation from calibration temp.		
Relative humidity	Type tested 0 to 95% at 40 °C, non-condensing		
Altitude	0 to 4600 m (15,000 ft.)		
Non-operating storage environment			
Temperature	-40 to +70 °C		
Cabinet dimensions			
	Height	Width	Depth
Excluding front and rear panel hardware and feet	267 mm 10.5 in	426 mm 16.75 in	427 mm 16.8 in
As shipped - includes front panel connectors, rear panel bumpers, and feet.	280 mm 11 in	435 mm 17.10 in	470 mm 18.5 in
As shipped plus handles	280 mm 11 in	458 mm 18 in	501 mm 19.7 in
As shipped plus rack-mount flanges	280 mm 11 in	483 mm 19 in	470 mm 18.5 in
As shipped plus handles and rack-mount flanges	280 mm 11 in	483 mm 19 in	501 mm 19.7 in
Weight			
Net			
N5230C	24.9 kg (55 lb), nominal		
Shipping			
N5230C	36.3 kg (80 lb), nominal		

Measurement Throughput Summary

Table 14. Typical cycle time¹ (ms) for measurement completion

	Number of Points				
	201	401	801	1601	16,001
Start 8 GHz, stop 18 GHz, 600 kHz IF bandwidth					
Uncorrected	21.148	21.743	23.01	25.198	54.836
4-Port cal	74.597	82.296	296.5	307.75	538.646
Start 300 kHz, stop 10 GHz, 600 kHz IF bandwidth					
Uncorrected	19.814	22.801	24.973	29.01	67.733
4-Port cal	69.752	85.111	100.125	129.347	480.711
Start 300 kHz, stop 20 GHz, 600 kHz IF bandwidth					
Uncorrected	32.575	34.7	39.237	43.155	69.625
4-Port cal	121.254	133.626	157.506	179.223	487.779
Start 8 GHz, stop 18 GHz, 100 kHz IF bandwidth					
Uncorrected	38.083	51.816	55.488	56.36	184.154
4-Port cal	143.271	201.814	215.056	230.133	934.161
Start 300 kHz, stop 10 GHz, 100 kHz IF bandwidth					
Uncorrected	37.03	42.532	45.122	46.729	198.683
4-Port cal	137.431	162.37	194.13	192.182	906.768
Start 300 kHz, stop 20 GHz, 100 kHz IF bandwidth					
Uncorrected	44.98	69.408	87.161	92.475	198.792
4-Port cal	169.041	268.877	343.898	369.526	914.963
Start 8 GHz, stop 18 GHz, 50 kHz IF bandwidth					
Uncorrected	42.171	70.09	88.702	90.981	371.611
4-Port cal	157.107	271.791	351.517	368.02	1532.609
Start 300 kHz, stop 10 GHz, 50 kHz IF bandwidth					
Uncorrected	43.713	61.41	66.878	69.373	385.04
4-Port cal	163.58	238.267	259.687	279.816	1580.761
Start 300 kHz, stop 20 GHz, 50 kHz IF bandwidth					
Uncorrected	48.673	80.798	124.605	147.303	388.46
4-Port cal	184.429	313.392	493.142	587.548	1587.839

1. Includes sweep time, retrace time and band-crossing time. Analyzer display turned off with DISPLAY:ENABLE OFF. Add 21 ms for display on. Data for one trace (S11) measurement.

Table 15. Cycle Time vs IF Bandwidth

Applies to the preset condition (201 points, correction off) except for the following changes:

- CF = 10 GHz
- Span = 100 MHz
- Display off (add 21 ms for display on)

Description IF Bandwidth (Hz)	Typical performance	
	Cycle time (ms) ¹	Trace noise (dB rms)
600,000	3.13	0.00544
360,000	3.21	0.00602
280,000	3.17	0.00321
200,000	3.17	0.00259
150,000	3.19	0.00207
100,000	4.05	0.00155
70,000	4.99	0.00144
50,000	6.41	0.00121
30,000	8.78	0.00094
20,000	12.07	0.00080
15,000	14.91	0.00069
10,000	26.02	0.00052
7000	34.54	0.00047
5000	45.87	0.00044
3000	69.91	0.00032
2000	99.69	0.00029
1500	128.18	0.00010
1000	215.62	0.00009
700	291.58	0.00006
500	397.36	0.00007
300	633.86	0.00000
200	930.15	0.00000
100	1824.19	0.00000
30	6001.70	0.00000
10	17899.79	0.00000
1	178391.58	0.00000

1. Cycle time includes sweep and retrace time.

Table 16. Cycle time vs number of points

Applies to the preset condition (correction off) except for the following changes:

- CF = 10 GHz
- Span = 100 MHz
- Display off (add 21 ms for display on)

IF Bandwidth (Hz)	Number of points	Cycle time (ms) ¹
30,000	3	2.88
	11	3.50
	51	3.91
	101	5.29
	201	8.75
	401	15.66
	801	29.46
	1,601	57.73
	6,401	221.04
	16,001	549.71
100,000	3	2.87
	11	2.82
	51	2.86
	101	2.96
	201	4.02
	401	6.23
	801	10.65
	1,601	19.49
	6,401	70.96
	16,001	173.78
600,000	3	2.84
	11	2.84
	51	2.87
	101	3.03
	201	3.14
	401	3.51
	801	4.22
	1,601	6.22
	6,401	19.35
	16,001	45.12

1. Cycle time includes sweep and retrace time.

Table 17. Data transfer time (ms)

	Number of points			
	201	401	1601	16,001
SCPI over GPIB (program executed on external PC)				
32-bit floating point	6	10	33	313
64-bit floating point	10	18	65	622
ASCII	53	105	406	4032
CPI over SIU/LAN or TCP/IP socket (program executed in the analyzer)				
32-bit floating point	1	2	2.5	7
64-bit floating point	2	2	3	10
ASCII	11	20	73	720
COM (program executed in the analyzer)				
32-bit floating point	< 0.2	0.2	0.3	0.9
Variant type	0.6	1	3.2	32
DCOM over LAN (program executed on external PC)				
32-bit floating point	< 0.8	1	1.6	7.5
Variant type	1.9	3	8.9	82

Note: Specifications for recall and sweep speed are not provided for the N5230C analyzers.

Specifications: Front-Panel Jumpers

Table 18: Measurement receiver inputs (rcvr A In, rcvr B In, rcvr C In, rcvr D In) 0.1 dB Typical compression

Description	Typical Options 145, 146, 245, 246
Maximum input level	
300 kHz to 10 MHz	-11 dBm
10 MHz to 1 GHz	-7 dBm
1 to 12.5 GHz	-6 dBm
12.5 to 13.5 GHz	-7 dBm
13.5 to 20 GHz	-7 dBm
Damage level	
N5230C	+15 dBm
Maximum DC level	
N5230C	±16 V

Table 19: Reference receiver input (rcvr in) at maximum specified output power

Description	Typical Options 145, 146, 245, 246
Maximum input level	
300 kHz to 10 MHz	-15 dBm
10 to 45 MHz	-15 dBm
45 to 500 MHz	-15 dBm
500 MHz to 4 GHz	-15 dBm
4 to 6 GHz	-16 dBm
6 to 10.5 GHz	-20 dBm
10.5 to 13.5 GHz	-21 dBm
13.5 to 15 GHz	-21 dBm
15 to 20 GHz	-27 dBm
Damage level	
N5230C	+15 dBm
Maximum DC level	
N5230C	±16 V

Table 20: Reference output (source out) at maximum specified output power

Description	Typical Options 145, 146, 245, 246
Maximum output level	
300 kHz to 10 MHz	-15 dBm
10 to 45 MHz	-15 dBm
45 to 500 MHz	-15 dBm
500 MHz to 4 GHz	-15 dBm
4 to 6 GHz	-15 dBm
6 to 10.5 GHz	-20 dBm
10.5 to 13.5 GHz	-21 dBm
13.5 to 15 GHz	-21 dBm
15 to 20 GHz	-27 dBm
Damage level	
N5230C	+27 dBm
Maximum DC level	
N5230C	±16 V

Table 21: Source outputs (port 1 source out, port 2 source out, port 3 source out, port 4 source out) at maximum specified output power

Description	Typical Options 145, 146, 245, 246
Maximum output level	
300 kHz to 10 MHz	+10 dBm
10 to 45 MHz	+10 dBm
45 to 500 MHz	+10 dBm
500 MHz to 4 GHz	+10 dBm
4 to 6 GHz	+9 dBm
6 to 10.5 GHz	+4 dBm
10.5 to 13.5 GHz	+1 dBm
13.5 to 15 GHz	+1 dBm
15 to 20 GHz	-4 dBm
Damage level	
N5230C	+27 dBm
Maximum DC level	
N5230C	±16 V

Table 22: Coupler inputs (port 1 cplr thru, port 2 cplr thru, port 3 cplr thru, port 4 cplr thru) Insertion loss of coupler thru

Description	Typical Options 145, 146, 245, 246
Insertion loss to test port	
300 kHz to 10 MHz	1.5 dB
10 to 45 MHz	1.5 dB
45 to 500 MHz	1.5 dB
500 MHz to 4 GHz	2.0 dB
4 to 6 GHz	2.5 dB
6 to 10.5 GHz	2.5 dB
10.5 to 13.5 GHz	3.0 dB
13.5 to 15 GHz	3.0 dB
15 to 20 GHz	3.0 dB
Damage level	
N5230C	+27 dBm
Maximum DC level	
N5230C	±16 V

Table 23: Coupler outputs (port 1 cplr arm, port 2 cplr arm, port 3 cplr arm, port 4 cplr arm)

Description	Typical Options 145, 146, 245, 246
Damage level	
N5230C	+15 dBm
Maximum DC level	
N5230C	0 V

Test Set Block Diagrams

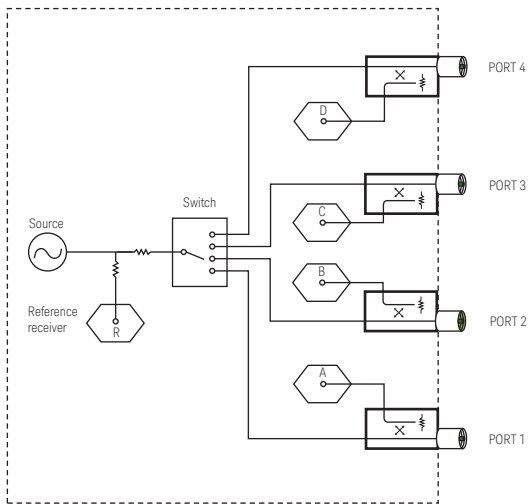

N5230C Option 140 or 240 standard test set and standard power range

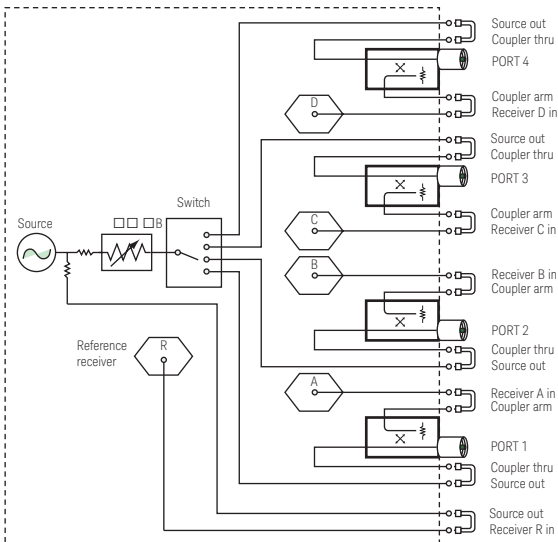

N5230C Option 145 or 245 configurable test set, extended power range

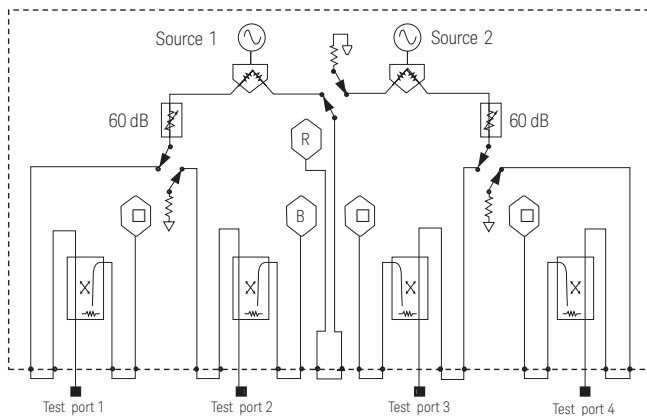

N5230C Option 146 or 246 configurable test set, extended power range, and internal second source



myKeysight

www.keysight.com/find/mykeysight

A personalized view into the information most relevant to you.

Intel and Pentium are US registered trademarks of Intel Corporation.

For more information on Keysight Technologies' products, applications or services, please contact your local Keysight office. The complete list is available at: www.keysight.com/find/contactus

Americas

Canada	(877) 894 4414
Brazil	55 11 3351 7010
Mexico	001 800 254 2440
United States	(800) 829 4444

Asia Pacific

Australia	1 800 629 485
China	800 810 0189
Hong Kong	800 938 693
India	1 800 112 929
Japan	0120 (421) 345
Korea	080 769 0800
Malaysia	1 800 888 848
Singapore	1 800 375 8100
Taiwan	0800 047 866
Other AP Countries	(65) 6375 8100

Europe & Middle East

Austria	0800 001122
Belgium	0800 58580
Finland	0800 523252
France	0805 980333
Germany	0800 6270999
Ireland	1800 832700
Israel	1 809 343051
Italy	800 599100
Luxembourg	+32 800 58580
Netherlands	0800 0233200
Russia	8800 5009286
Spain	800 000154
Sweden	0200 882255
Switzerland	0800 805353
	Opt. 1 (DE)
	Opt. 2 (FR)
	Opt. 3 (IT)
United Kingdom	0800 0260637

For other unlisted countries:
www.keysight.com/find/contactus
 (BP-09-23-14)