

Keysight X-Series Signal Generators

N5171B/72B/73B EXG
N5181B/82B/83B MXG

Notice: This document contains references to Agilent. Please note that Agilent's Test and Measurement business has become Keysight Technologies. For more information, go to www.keysight.com.

Notices

© Keysight Technologies 2006-2014

No part of this manual may be reproduced in any form or by any means (including electronic storage and retrieval or translation into a foreign language) without prior agreement and written consent from Keysight Technologies, Inc. as governed by United States and international copyright laws.

Manual Part Number

N5180-90054

Edition

December 2014

Published in USA

Keysight Technologies
1400 Fountaingrove Pkwy.
Santa Rosa, CA 95403 USA

Warranty

THE MATERIAL CONTAINED IN THIS DOCUMENT IS PROVIDED "AS IS," AND IS SUBJECT TO BEING CHANGED, WITHOUT NOTICE, IN FUTURE EDITIONS. FURTHER, TO THE MAXIMUM EXTENT PERMITTED BY APPLICABLE LAW, KEYSIGHT DISCLAIMS ALL WARRANTIES, EITHER EXPRESS OR IMPLIED WITH REGARD TO THIS MANUAL AND ANY INFORMATION CONTAINED HEREIN, INCLUDING BUT NOT LIMITED TO THE IMPLIED WARRANTIES OF MERCHANTABILITY AND FITNESS FOR A PARTICULAR PURPOSE. KEYSIGHT SHALL NOT BE LIABLE FOR ERRORS OR FOR INCIDENTAL OR CONSEQUENTIAL DAMAGES IN CONNECTION WITH THE FURNISHING, USE, OR PERFORMANCE OF THIS DOCUMENT OR ANY INFORMATION CONTAINED HEREIN. SHOULD KEYSIGHT AND THE USER HAVE A SEPARATE WRITTEN AGREEMENT WITH WARRANTY TERMS COVERING THE MATERIAL IN THIS DOCUMENT THAT CONFLICT WITH THESE TERMS, THE WARRANTY TERMS IN THE SEPARATE AGREEMENT WILL CONTROL.

Technology Licenses

The hardware and/or software described in this document are furnished under a license and may be used or copied only in accordance with the terms of such license.

Restricted Rights Legend

U.S. Government Restricted Rights. Software and technical data rights granted to the federal government include only those rights customarily provided to end user customers. Keysight provides this customary commercial license in Software and technical

data pursuant to FAR 12.211 (Technical Data) and 12.212 (Computer Software) and, for the Department of Defense, DFARS 252.227-7015 (Technical Data - Commercial Items) and DFARS 227.7202-3 (Rights in Commercial Computer Software or Computer Software Documentation).

Safety Notices

CAUTION

A CAUTION notice denotes a hazard. It calls attention to an operating procedure, practice, or the like that, if not correctly performed or adhered to, could result in damage to the product or loss of important data. Do not proceed beyond a CAUTION notice until the indicated conditions are fully understood and met.

WARNING

A WARNING notice denotes a hazard. It calls attention to an operating procedure, practice, or the like that, if not correctly performed or adhered to, could result in personal injury or death. Do not proceed beyond a WARNING notice until the indicated conditions are fully understood and met.

Table of Contents

1. Safety Information

Warnings, Cautions, and Notes 1

General Safety Considerations 2

Instrument Markings 3

2. Getting Started

Checking the Shipment 7

Signal Generator Physical Characteristics 8

Meeting Environmental and Electrical Requirements 9

 Environment 9

 Ventilation 10

 Line Setting Requirements 10

 Connecting the AC Power Cord 11

Configuring the Display 12

Configuring for Remote Control 13

 LAN Configuration 13

 GPIB Configuration 14

Ordering Accessories 15

Proper Use and Cleaning 17

 Cleaning Suggestions 17

Returning a Signal Generator to Keysight Technologies 17

Contacting Keysight 19

3. Operation Verification

Running Self Test 22

 Self Test Failure 23

Frequency Range and Accuracy Check 24

 Frequency Counter Procedure 24

 Troubleshooting Problems with the Frequency Accuracy Check 26

Checking the Output Power 26

 N5171B/81B Test Procedure 27

 N5171B/81B Alternative Test Procedure 28

 N5172B/82B Test Procedure 30

 N5172B/82B Alternative Test Procedure 33

 N5173B/83B Test Procedure 34

 N5173B/83B Alternative Test Procedure 35

 Troubleshooting Problems with the Output Power Check 37

4. Regulatory Information

Certification 39

Assistance 39

Statement of Compliance 39

Compliance with Canadian EMC Requirements 39

Contents

Compliance with European Machinery Directive Acoustic Requirement	40
5. Open Source Licenses	
Apple mDNSResponder	42
Sun ONC/RPC	48
WCELIBCEX - Windows CE C Library Extensions	49

Documentation Overview

Installation Guide

- Safety Information
- Receiving the Instrument
- Environmental & Electrical Requirements
- Basic Setup
- Accessories
- Operation Verification
- Regulatory Information

User's Guide

- Signal Generator Overview
- Setting Preferences & Enabling Options
- Basic Operation
- Optimizing Performance
- Using Analog Modulation (Option UNT Only)
- Using Pulse Modulation (Option UNW Only)
- Basic Digital Operation - No BBG Option Installed
- Basic Digital Operation (Option 653/655/656/657)
- Adding Real-Time Noise to a Signal (Option 403)
- Real-Time Phase Noise Impairments (Option 432)
- Custom Digital Modulation (Option 431)
- Multitone and Two-Tone Waveform Generator (Option 430)
- Working in a Secure Environment
- Troubleshooting

Programming Guide

- Getting Started with Remote Operation
- Using IO Interfaces
- Programming Examples
- Programming the Status Register System
- Creating and Downloading Files
- Creating and Downloading User-Data Files

SCPI Reference	<ul style="list-style-type: none"> - SCPI Basics - Basic Function Commands - System Commands - Analog Modulation Commands - Arb Commands - Real-Time Commands
Programming Compatibility Guide	<ul style="list-style-type: none"> - Provides a listing of SCPI commands and programming codes for signal generator models that are supported by the Keysight N5171B/72B EXG and N5181B/82B MXG X-Series signal generators.
Service Guide	<ul style="list-style-type: none"> - Troubleshooting - Replaceable Parts - Assembly Replacement - Post-Repair Procedures - Safety and Regulatory Information - Instrument History
Key Help^a	<ul style="list-style-type: none"> - Key function description - Related SCPI commands

a. Press the Help hardkey, and then the key for which you wish help.

1 Safety Information

- **Warnings, Cautions, and Notes** on page 1
- **General Safety Considerations** on page 2
- **Instrument Markings** on page 3

Warnings, Cautions, and Notes

The documentation for this product uses the following safety notations. Familiarize yourself with each notation and its meaning before operating the signal generator.

WARNING *Warning* denotes a hazard. It calls attention to a condition or situation that could result in personal injury or loss of life. Do not proceed beyond a warning until you fully understand the indicated conditions or situations.

CAUTION *Caution* calls attention to a condition or situation that could result in damage to or destruction of the signal generator, or in the loss of a user's settings or data. Do not proceed beyond a caution until you fully understand the indicated conditions.

NOTE *Note* calls the user's attention to an important point or special information in the text.













General Safety Considerations

WARNING If the signal generator is not used as specified, the protection provided by the equipment could be impaired. The signal generator must be used in a normal condition only, in which all means for protection are intact.

WARNING Personal injury may result if the signal generator covers are removed. There are no operator serviceable parts inside. To avoid electrical shock, refer servicing to qualified personnel.

Instrument Markings

The signal generator has the following markings. Familiarize yourself with each marking and its meaning before operating the signal generator.

	This symbol marks the standby position of the power line switch.
	This symbol indicates that the input power required is AC.
	The instruction manual symbol. The product is marked with this symbol when it is necessary for you to refer to instructions in the manual.
	The CE mark is a registered trademark of the European Community. If this symbol is accompanied by a year, it is the year when the design was proven.
	The CSA mark is a registered trademark of the Canadian Standards Association International.
	The C-Tick Mark is a trademark registered to the Australian Spectrum Management Agency. This indicates compliance with all Australian EMC regulatory information.
ICES/NMB-001	This is a marking to indicate product compliance with the Canadian Interference-Causing Equipment Standard (ICES-001)
	This is the symbol of an Industrial Scientific and Medical Group 1 Class A Product. (CISPER 11, Clause 4)
	This symbol indicates conformance to the standard specifications.
	Indicates the time period during which no hazardous or toxic substance elements are expected to leak or deteriorate during normal use. Forty years is the expected useful life of the product.
	This symbol indicates separate collection for electrical and electronic equipment, mandated under EU law as of August 13, 2005. All electric and electronic equipment are required to be separated from normal waste for disposal (Reference WEEE Directive, 2002/96/EC).
	This symbol on all primary and secondary packaging indicates compliance to China standard GB 18455-2001.
	This equipment is Class A suitable for professional use and is for use in electromagnetic environments outside of the home. South Korean Class A EMC Declaration A 급 기기 (업무용 방송통신기자재) 이 기기는 업무용 (A 급) 전자파적합기기로서 판매자 또는 사용자는 이 점을 주의하시기 바라 며 , 가정외의 지역에서 사용하는 것을 목적으로 합니다.

Safety Information
Instrument Markings

2 Getting Started

CAUTION To avoid damaging or degrading the performance of the signal generator, do not exceed 33 dBm (2W) **maximum** of reverse power levels at the RF input. See also **Tips for Preventing Signal Generator Damage** on www.keysight.com.

NOTE Software Updates

Is your product software up-to-date? Periodically, Keysight releases software updates to fix known defects and incorporate product enhancements. To search for software updates for your product, go to the Keysight Technical Support website at www.keysight.com/find/TechSupport.

NOTE Documentation Updates

Is your product documentation up-to-date? To search for documentation updates for your product, go to the Keysight X-Series Signal Generators website at www.keysight.com/find/X-Series_SG.

- [Checking the Shipment](#) on page 7
- [Signal Generator Physical Characteristics](#) on page 8
- [Meeting Environmental and Electrical Requirements](#) on page 9
- [Configuring the Display](#) on page 12
- [Configuring for Remote Control](#) on page 13
- [Ordering Accessories](#) on page 15
- [Proper Use and Cleaning](#) on page 17

Getting Started

- [Returning a Signal Generator to Keysight Technologies](#) on page 17
- [Contacting Keysight](#) on page 19

Checking the Shipment

1. Inspect the shipping container for damage.

Signs of damage can include a dented or torn shipping container or cushioning material that indicates signs of unusual stress or compacting.

2. Carefully remove the contents from the shipping container and verify that your order is complete.

The following items are included with each signal generator:

- Getting Started Guide
 - documentation CD-ROM (CD-ROM contents are also available in hardcopy format)
 - three-prong AC power cord specific to geographic location
- 3. Verify that the options you ordered are included with the shipment by checking the serial number label on the rear of the signal generator and the packing literature included with the shipment.**

See also, [“Ordering Accessories” on page 15.](#)

Signal Generator Physical Characteristics

- Height: 8.8 cm (3.46 in)
- Depth: 50.8 cm (20 in)
- Width (N5171B/81B/72B/82B): 45.8 cm (18 in)
- Width (N5173B/83B): 44.5 cm (17.5 in)
- Weight (N5171B/81B): 13.6 kg (30 lb)
- Weight (N5172B/82B): 15.9 kg (35 lb)
- Weight (N5173B/83B): 13.8 kg (30 lb)

Meeting Environmental and Electrical Requirements

CAUTION To avoid the loss of data, GPIB settings, or current user instrument states that have not been permanently saved to non-volatile memory, the signal generator should always be powered down either via the signal generator's front panel power button or the appropriate SCPI command. Signal generator's installed in rack systems and powered down with the system rack power switch rather than the signal generator's front panel switch display a Error -310 due to the signal generator not being powered down correctly.

Environment

- indoor use
- altitudes < 15,000 feet (4,572 meters)
- 0 to 55°C temperature, unless otherwise specified
- humidity 10% - 95%

CAUTION This product is designed for use in INSTALLATION CATEGORY II and POLLUTION DEGREE 2, per IEC 61010-1 Third Edition.

NOTE The instruments can operate with mains supply voltage fluctuations up to $\pm 10\%$ of the nominal voltage.

Ventilation

Ventilation holes are located on the rear panel and all four sides of the signal generator cover. To ensure proper air flow through the signal generator, do not allow these holes to be obstructed.

Line Setting Requirements

CAUTION The signal generator has autoranging line voltage input; ensure that the supply voltage is within the specified range.

Voltage:	100/120 volts nominal 220/240 volts nominal
Frequency:	for 100/120 volts: 50/60/400 Hz nominal for 220/240 volts: 50/60 Hz nominal
Power:	160 W maximum (N5171B & N5181B) 300 W maximum (N5172B & N5182B) 280 W maximum (N5173B & N5183B)

Connecting the AC Power Cord

This is a Safety Class 1 Product provided with a protective earth ground incorporated into the power cord. The front panel switch is only a standby switch; it is not a line switch. The AC power cord is the disconnecting device that disconnects the signal generator mains circuits from the mains supply. Alternatively, an external switch or circuit breaker, readily identifiable and easily reached by the operator, may be used as a disconnecting device.

WARNING The instrument shall be set flat in its normal use position so that the detachable power cord is readily identifiable and is easily reached by the operator. It shall not be placed on the four feet of the rear panel in normal use.

WARNING The mains plug shall be inserted only in a socket outlet provided with a protective earth contact. Always use the three-prong AC power cord supplied with the signal generator. Personal injury can occur if there is any interruption of the protective conductor inside or outside of the signal generator. Intentional interruption is prohibited.

CAUTION The mains wiring and connectors shall be compatible with the connector used in the premise electrical system. Inadequate earth grounding can damage the signal generator. Always use the three-prong AC power cord supplied with the signal generator.

Connect the AC power cord as follows:

1. Ensure that the power cord is not damaged.
2. Install the signal generator so that one of the following items is readily identifiable and easily reached by the operator: AC power cord, alternative switch, or circuit breaker.
3. Insert the mains plug into a socket outlet provided with a protective earth grounding.

Configuring the Display

Screen saver settings are persistent states; they are unaffected by preset or a power cycle.

Use the arrow keys, numeric keypad, or front panel knob to adjust numeric values.

NOTE

X-Series signal generators are shipped from the factory with default display settings. When the signal generator display is not required to be active for long periods of time, consider using the Screen Saver Mode to extend the life of the display.

Figure 2-1

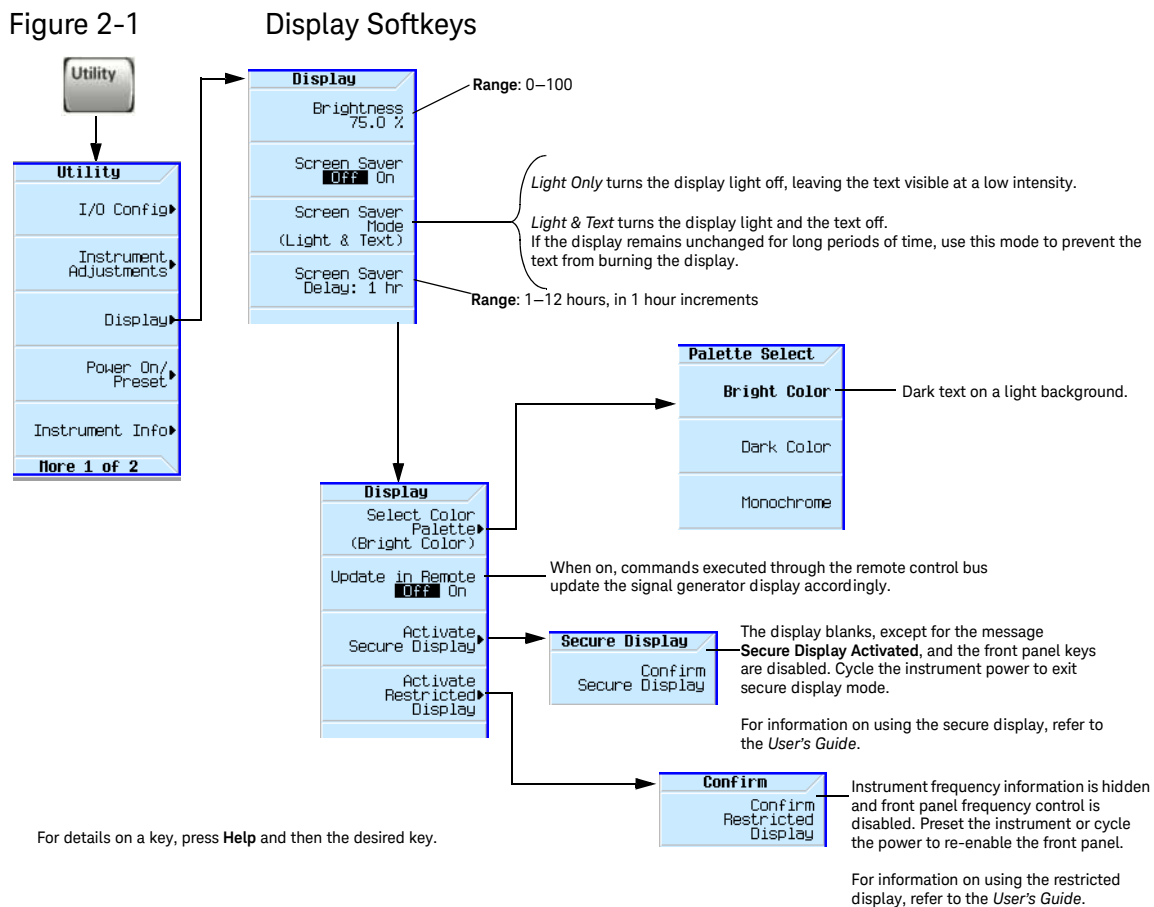

NOTE

With the brightness set to minimum, the display may be too dark to see the softkeys. If this happens, use [Figure 2-1](#) to locate the brightness softkey and adjust the value so that you can see the display.

Configuring for Remote Control

LAN Configuration

Configuring the LAN Interface

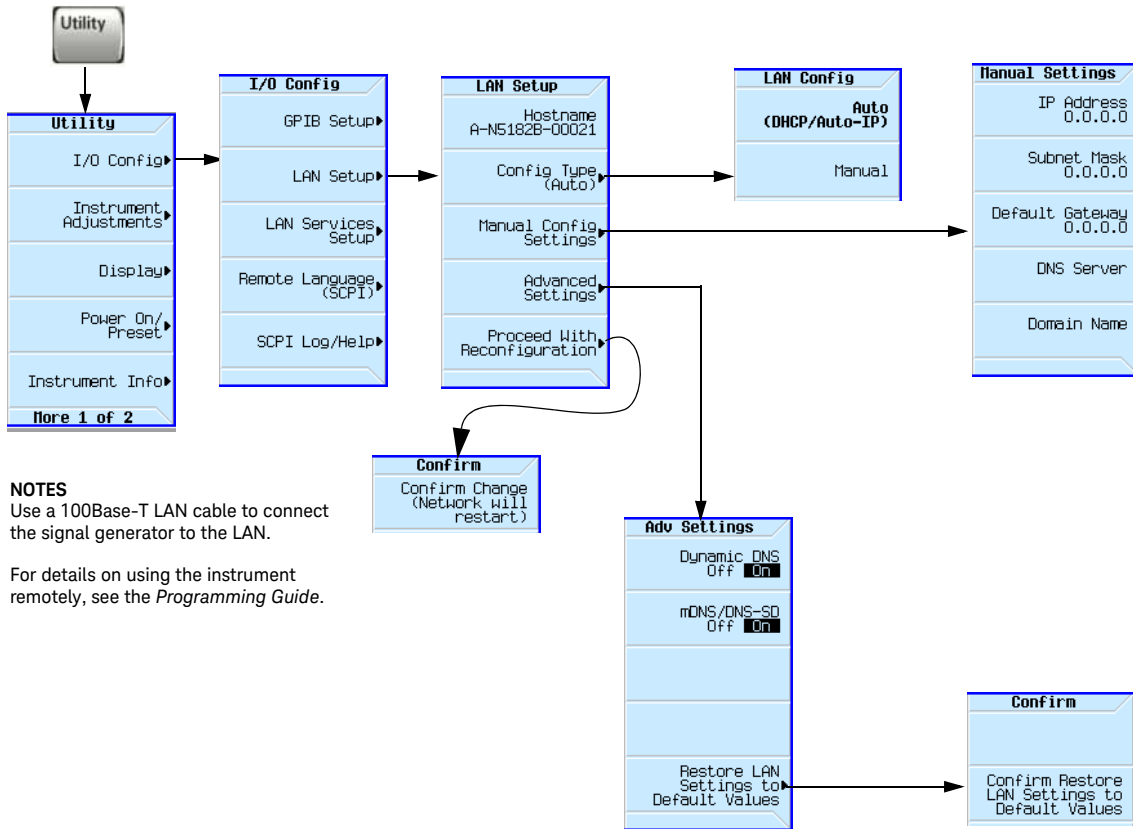

NOTES
Use a 100Base-T LAN cable to connect the signal generator to the LAN.

For details on using the instrument remotely, see the *Programming Guide*.

For details on a key, press **Help** and then the desired key.

Enabling LAN Services: Browser, Sockets, and VXI-11

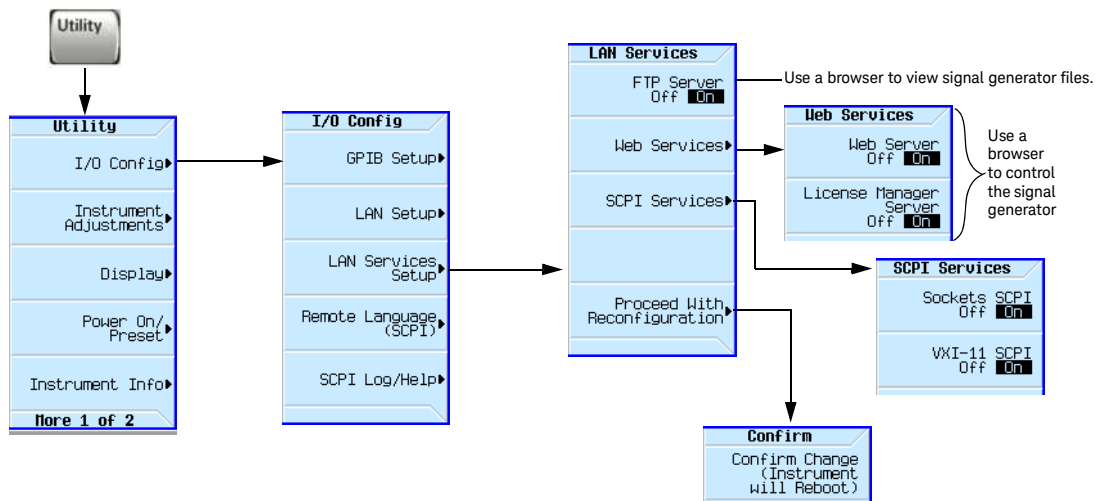

GPIB Configuration

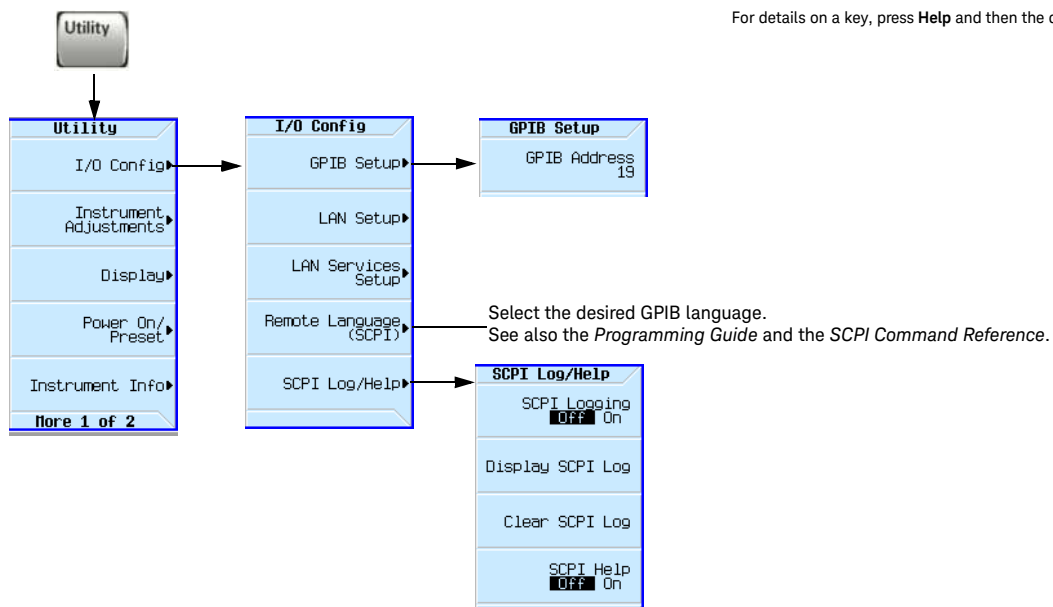

NOTES
USB is also available. It is not shown in the menu because it requires no configuration.
For details on using the instrument remotely, see the *Programming Guide*.

Ordering Accessories

You can purchase accessories or documentation at:

<http://www.keysight.com/find/mxg>

If you do not have access to the Internet, please contact your Keysight field engineer.

See also, “[Contacting Keysight](#)” on page 19.

Description ^a	Part Number
Rack Mount Kit	1CM010A
Rack Mount Kit with Handles	1CP004A
Rack Slide Kit	1CR012A
Front Handle Kit	1CN006A
Transit Case (See Figure 2-2 on page 16)	N5180-80053
EXG Data Sheet (N5171B/72B/73B) ^b	5991-0039EN
MXG Data Sheet (N5181B/82B/83B) ^b	5991-0038EN
Getting Started Guide ^b	N5180-90054
User's Guide ^b	N5180-90056
SCPI Reference ^b	N5180-90057
Programming Guide ^b	E8251-90355
Service Guide ^b	N5180-90059
Documentation CD-ROM ^b : PDF files: – Data Sheet – Documentation Set – Getting Started Guide Text files: – error messages – programming examples	N5180-90058

a. For a description of the contents of each guide and reference, see [page v](#).

b. Always refer to www.keysight.com for the most up-to-date documentation.

Figure 2-2

Transit Case

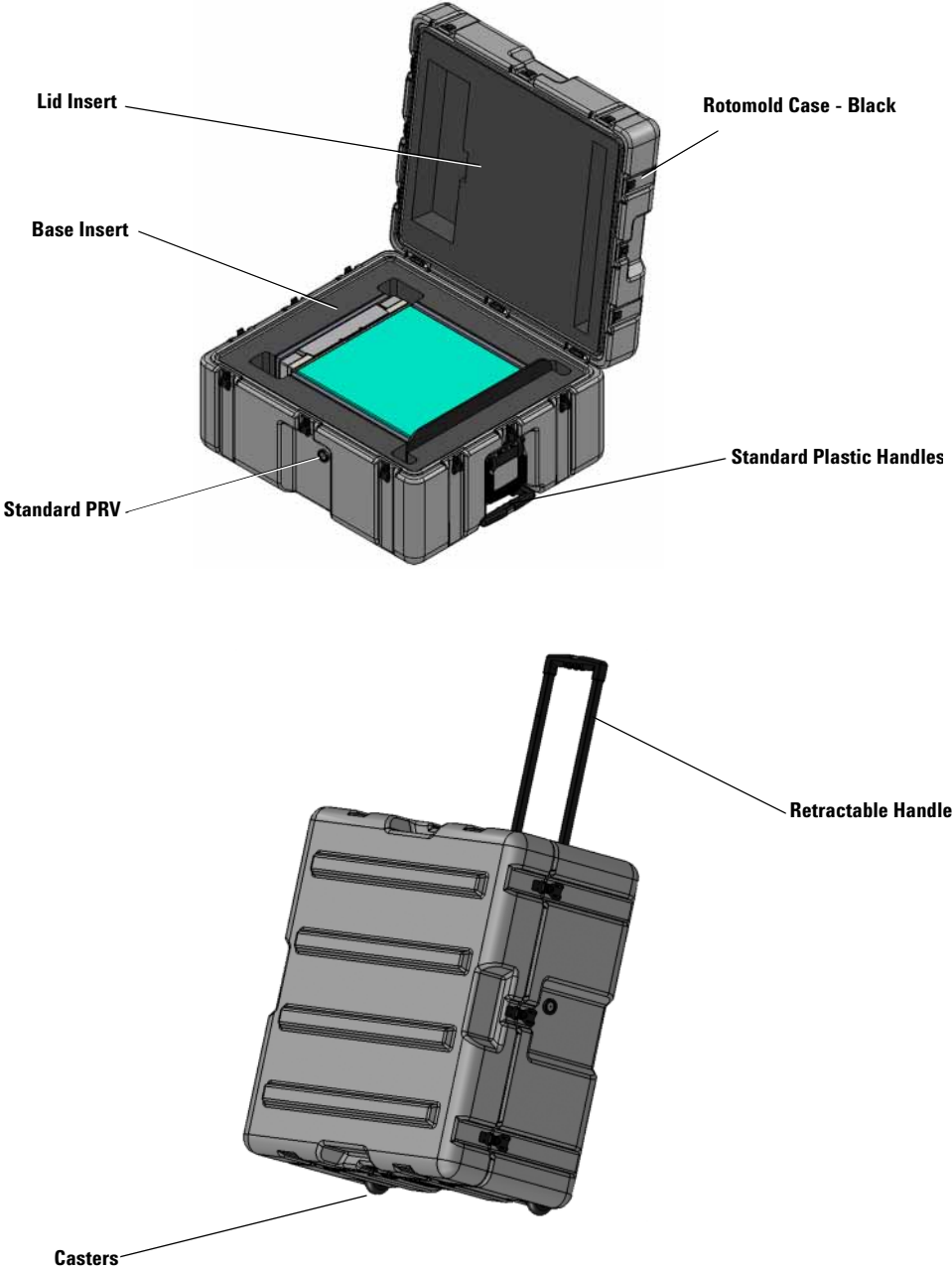

Proper Use and Cleaning

The signal generator cover protects against physical contact with internal assemblies that contain hazardous voltages, but does not protect internal assemblies against contact with liquids. To avoid damage and personal injury, ensure that liquids are positioned away from the signal generator.

WARNING Personal injury may result if the signal generator is not used as specified. Unspecified use impairs the protection provided by the equipment. The signal generator must be used with all means for protection intact.

Cleaning Suggestions

WARNING To prevent electrical shock, disconnect the instrument from mains before cleaning. Use a dry cloth or one slightly dampened with water to clean the external case parts. Do not attempt to clean internally.

Cleaning connectors with alcohol shall only be done with the instrument's power cord removed, and in a well-ventilated room. Allow all residual alcohol moisture to evaporate, and the fumes to dissipate prior to energizing the instrument.

To ensure good connections, regularly clean the instrument's front and rear panel connectors with alcohol.

To prevent dust build-up that could potentially obstruct ventilation, periodically clean the instrument's cover. Use a dry cloth or a cloth slightly dampened with water to clean the external case parts.

Returning a Signal Generator to Keysight Technologies

1. Gather as much information as possible about the signal generator's problem.
2. Contact Keysight using the phone number that is specific to your geographic location. These phone numbers are listed on the Internet at <http://www.keysight.com/find/assist>. If you do not have access to the Internet, contact your Keysight field engineer.

After you provide information about the signal generator and its condition, you will receive information about where to ship your signal generator for repair.

- 3. Ship the signal generator in the original factory packaging materials, if available, or use similar packaging to properly protect the signal generator.**

Contacting Keysight

Assistance with test and measurements needs, information on finding a local Keysight office, and information on purchasing accessories and documentation are available on the Internet at: **<http://www.keysight.com/find/assist>**

If you do not have access to the Internet, please contact your Keysight field engineer.

NOTE

In correspondence or telephone conversation, refer to the signal generator by its model number and full serial number. With this information, the Keysight representative can determine if your unit is still within its warranty period.

Getting Started
Contacting Keysight

3 Operation Verification

CAUTION To avoid damaging or degrading the performance of the signal generator, do not exceed 33 dBm (2W) **maximum** of reverse power levels at the RF input. See also **Tips for Preventing Signal Generator Damage** on www.keysight.com.

NOTE For the instrument to meet performance specifications allow a warm up period of 45 minutes within an operational temperature range of 0 to 55 °C. For more information, refer to the EXG and MXG signal generator **Data Sheets**.

Operation verification is a series of tests used to confirm that the signal generator is operating properly, or to diagnose problems. Operation verification does not verify performance to instrument specifications.

Perform operation verification when you initially set up the signal generator, after a minor repair (refer to the **Service Guide** for details), or when the integrity of the signal generator is in question.

- **Running Self Test** on page 22
- **Frequency Range and Accuracy Check** on page 24
- **Checking the Output Power** on page 26

Running Self Test

Self Test is a series of internal tests of signal generator functions. If this test fails, refer to **“Self Test Failure” on page 23** for further instructions.

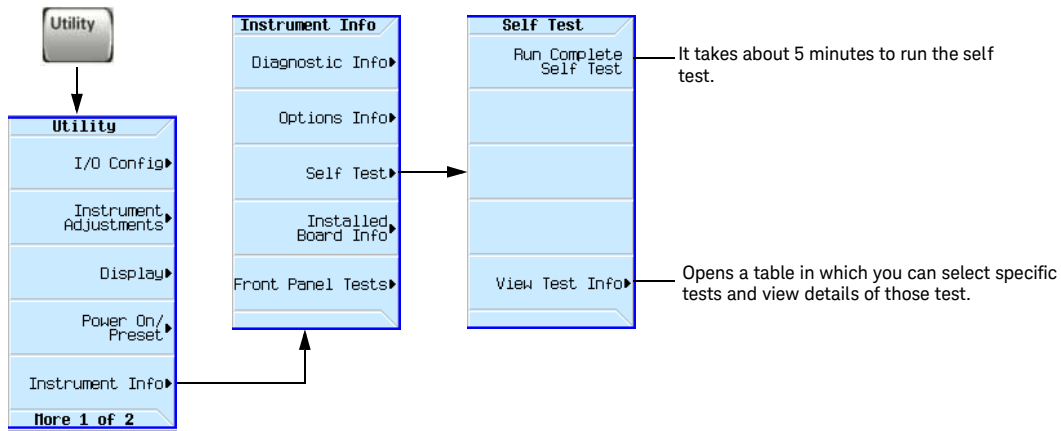

Use the following procedure to run self test:

1. Disconnect all external cables, including GPIB, LAN, and USB cables.
2. Preset the signal generator: Press **Preset > Utility > Instrument Info > Self Test**.

The following message appears:

- The current status of the self-test is: Incomplete. Not all tests have been run.

3. Press **Run Complete Self Test**.

An activity bar displays on the screen indicating the test progress.

If you press **Abort** while self-test is running, the following message displays:

- The current status of the self-test is: Incomplete. Not all tests have been run.

When self-test completes, one of the following messages displays:

- The current status of the self-test is: Passed
- The current status of the self-test is: Failure. One or more tests have failed. System diagnostics indicate this test as the root failure: xxx

If the signal generator fails only one test, the title of the failed test displays. If the signal generator fails more than one test, the test number of the most significant failure (root failure) displays.

NOTE

The `root failure` is the error to report to Keysight Support. Refer to [“Contacting Keysight” on page 19](#).

Self Test Failure

1. Confirm that all external cables, including GPIB, LAN, and USB cables, are disconnected from the signal generator and repeat the self-test.
2. If the self-test continues to fail, the signal generator requires service. If you are unable to service the signal generator, send it to an Keysight service center for repair. Include a detailed description of the most significant failure (`root failure`) and any displayed error messages. Also include the model, serial number, installed options, and firmware version.

See [“Returning a Signal Generator to Keysight Technologies” on page 17](#) for return instructions.

Viewing Test Results

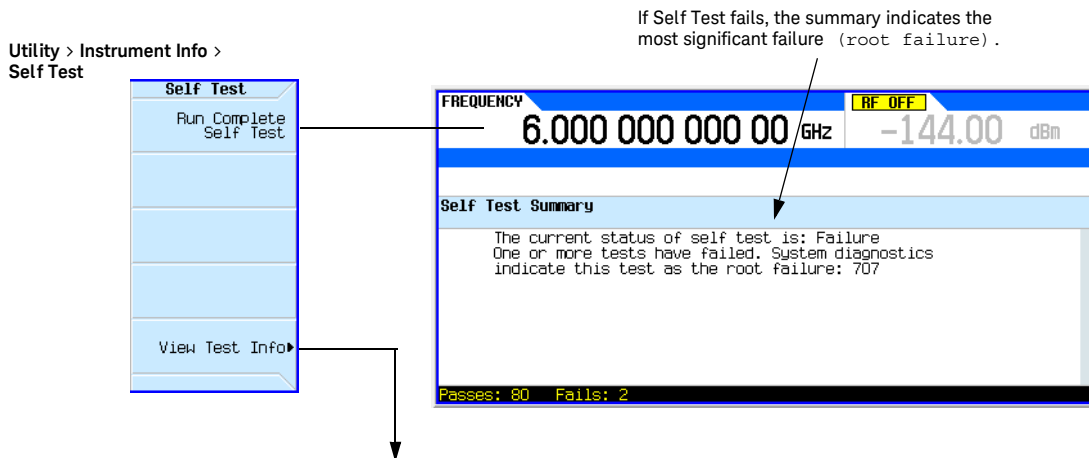

This information is *supplemental*. Please disregard unless Keysight *specifically requests* this information.

Frequency Range and Accuracy Check

The frequency range is tested by determining the frequency accuracy relative to the timebase at the frequency limits of the signal generator. This test can be performed with a frequency counter that meets the frequency accuracy limits in [Table 3-1](#).

Frequency Counter Procedure

Test Setup

1. Connect the equipment as shown.

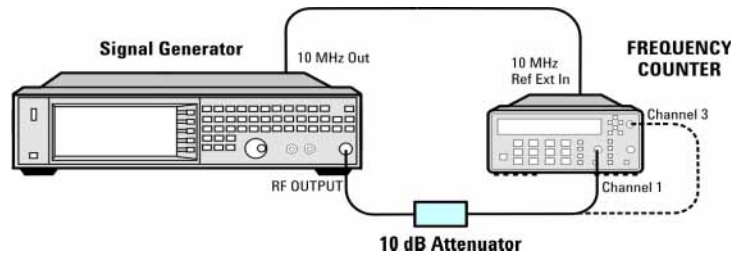

2. Preset the signal generator: Press **Preset**.
3. Turn modulation off: Press the **Mod On/Off** so that the MOD On/Off LED turns off.
4. Set the amplitude:
Press **Amplitude** and enter 0 dBm.
5. Turn RF on: Press **RF On/Off** so that the RF On/Off LED lights.
6. Verify that the frequency counter is locked to the 10 MHz external reference frequency (± 1 Hz).
7. For maximum accuracy, set the gate time on the frequency counter to >5 seconds.
(For example, press **Gate & ExtArm** twice and use the arrow keys to set the value.)
8. Set the frequency: Press **Frequency** and set the signal generator to the first frequency listed in [Table 3-1](#).
9. Confirm that the measured frequency is within the limits listed.
10. Repeat step 8 and step 9 for all of the frequencies in the table that are within the frequency range of your signal generator.

NOTE For frequencies <200 MHz, use Channel 3 on the frequency counter (press **Freq Ratio** until CH3 : displays).

Table 3-1 Frequency Accuracy Limits

Frequency (MHz)	Limit (Hz)
0.01 MHz	±2
0.1 MHz	±2
200 MHz	±2
300 MHz	±2
500 MHz	±2
1000 MHz	±2
2000 MHz	±2
3100 MHz	±2
6000 MHz	±2

Troubleshooting Problems with the Frequency Accuracy Check

- Verify the cables are connected correctly.
- If you are using a frequency counter, verify that you are using the correct channel for the frequencies you are measuring.

Checking the Output Power

This test verifies that the CW output power from the signal generator is within defined limits. The following table lists the preferred equipment for this test.

Test Equipment	Recommended Model
Power Meter	Keysight E4418B or E4419A/B E-Series or equivalent
Power Sensor, Input: Type-N (m)	Keysight E9304A

- [N5171B/81B Test Procedure](#) on page 27
- [N5171B/81B Alternative Test Procedure](#) on page 28
- [N5172B/82B Test Procedure](#) on page 30
- [N5172B/82B Alternative Test Procedure](#) on page 33
- [N5173B/83B Test Procedure](#) on page 34
- [N5173B/83B Alternative Test Procedure](#) on page 35

If this test fails, refer to [“Troubleshooting Problems with the Output Power Check” on page 37](#) for further instructions.

N5171B/81B Test Procedure

Test Setup 1. Connect the equipment as shown:

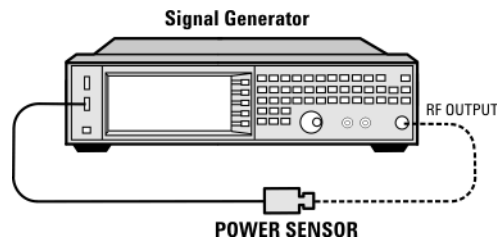

2. Zero and calibrate the power sensor.

NOTE

USB U2000A Series Power Sensors do not require the sensor to be zeroed or calibrated.

3. Connect the power sensor to the RF output of the signal generator. Once the LED on the power sensor turns off, the sensor is ready to measure.
4. Preset the signal generator: Press **Preset**
5. Turn the internal power meter channel on: Press **Aux Fctn** > **Power Meter Measurements** > **Channel A On** (or **Channel B On**).
6. Turn RF on: Press **RF On/Off** so that the RF On/Off LED lights.
7. Turn modulation off: Press **Mod On/Off** so that the **Mod On/Off** LED turns off.
8. Set the frequency: Press **Frequency** and enter the first frequency value listed in [Table 3-2](#).
9. Set the amplitude: Press **Amplitude** and enter the amplitude value for that frequency.
10. Measure the output power level.
11. Repeat steps 8 through 10 to measure power at each of the frequencies listed in [Table 3-2](#).
12. Confirm that the measured power levels are within the limits listed in the table.

N5171B/81B Alternative Test Procedure

If a USB power sensor is not available, use a power meter to measure the output power of the signal generator.

Test Setup

1. Zero and calibrate the power sensor to the power meter:

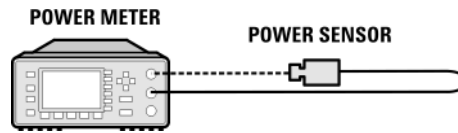

2. Connect the equipment as shown:

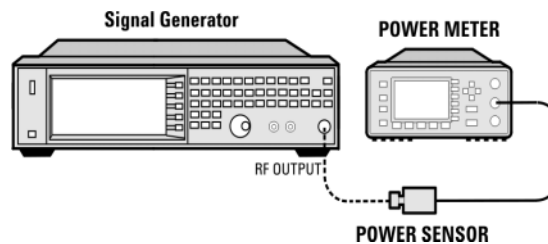

3. Preset the signal generator: Press **Preset**.
4. Turn RF on: Press **RF On/Off** so that the RF On/Off LED lights.
5. Turn modulation off: Press **Mod On/Off** so that the Mod On/Off LED turns off.
6. Set the frequency: Press **Frequency** and enter the first frequency value listed in [Table 3-2](#).
7. Set the amplitude: Press **Amplitude** and enter the amplitude value for that frequency.
8. Configure the power meter for the measurement.
 - a. Press the **Frequency Cal Fac** button on the power meter.
 - b. Select a power meter channel (if applicable).
 - c. Use the arrow keys to enter the frequency at which to measure the power.
9. Measure the output power level.
10. Repeat steps 6 through 9 to measure power at each of the 15 frequencies listed in [Table 3-2](#).
11. Confirm that the measured power levels are within the limits listed in the table.

NOTE Limit values are due to power meter uncertainty.

Table 3-2 Leveled Output Power Limits

N5171B/81B Output Power		
Frequency	Amplitude (dBm)	Limits (dB)
125 MHz	7	±2
275 MHz	7	±2
338 MHz	7	±2
425 MHz	7	±2
538 MHz	7	±2
675 MHz	7	±2
850 MHz	7	±2
1075 MHz	7	±2
1350 MHz	7	±2
1700 MHz	7	±2
2150 MHz	7	±2
2700 MHz	7	±2
3400 MHz	7	±2
4300 MHz	7	±2
5400 MHz	7	±2

N5172B/82B Test Procedure

Test Setup 1. Connect the equipment as shown:

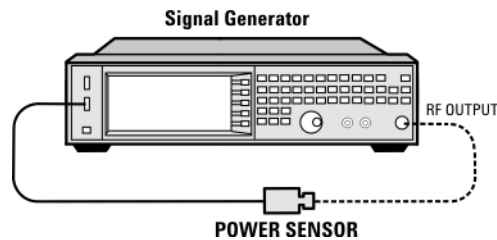

2. Zero and calibrate the power sensor.

NOTE USB U2000A Series Power Sensors do not require the sensor to be zeroed or calibrated.

3. Connect the power sensor to the RF output of the signal generator. Once the LED on the power sensor turns off, the sensor is ready to measure.
4. Preset the signal generator: Press **Preset**
5. Turn the internal power meter channel on: Press **Aux Fctn** > **Power Meter Measurements** > **Channel A On** (or **Channel B On**).
6. Turn RF on: Press **RF On/Off** so that the RF On/Off LED lights.
7. Turn modulation off: Press **Mod On/Off** so that the **Mod On/Off** LED turns off.
8. Set the frequency: Press **Frequency** and enter the first frequency value listed in [Table 3-3](#).
9. Set the amplitude: Press **Amplitude** and enter the amplitude value for that frequency.
10. Measure the output power level.
11. Repeat steps 8 through 10 to measure power at each of the frequencies listed in [Table 3-3](#).
12. Confirm that the measured power levels are within the limits listed in the table.

Without
Modulation

- a. Set the signal generator frequency to the first value listed in [Table 3-3](#):
Press **Frequency** > **250** > **MHz**.
- b. Set the amplitude to 7 dBm:
Press **Amplitude** > **7** > **dBm**.

- c. If using a power meter, configure the power meter as follows:
 - 1. On the power meter, press the **Frequency Cal Fac** button.
 - 2. If applicable, select a power meter channel.
 - 3. Use the arrow keys to enter the frequency at which to measure the power.
- d. Measure the output power level.
- e. Repeat steps a through d for the remaining frequencies in the table, and confirm that the power level at each point is within limits.

Table 3-3 Output Power without Modulation

N5172B/82B Output Power without Modulation		
Frequency (MHz)	Amplitude (dBm)	Limits (dB)
250	7	±2
338	7	±2
425	7	±2
538	7	±2
675	7	±2
850	7	±2
1075	7	±2
1350	7	±2
1700	7	±2
2150	7	±2
2700	7	±2
3400	7	±2
4300	7	±2
5400	7	±2

- With Modulation
- 13. Preset the signal generator: Press **Preset**.
 - 14. Select the factory-supplied waveform `SINE_TEST_WFM`:
 - a. Press **Mode > Dual ARB > Select Waveform**.
 - b. Highlight the `SINE_TEST_WFM` waveform.
 - c. Press **Select Waveform**.

15. Turn the arbitrary waveform player on: Press the **ARB** softkey to highlight **On**.
16. Set the frequency to the first value listed in **Table 3-4**:
Press **Frequency > 250 > MHz**.
17. Set the amplitude to 7 dBm:
Press **Amplitude > 7 > dBm**.
18. If using a power meter, configure the power meter as follows:
 - a. On the power meter, press the **Frequency Cal Fac** button.
 - b. Select a power meter channel (if applicable).
 - c. Use the arrow keys to enter the frequency at which to measure the power.
19. Measure the output power.
20. Repeat steps 16 through 19 for the remaining frequencies listed in **Table 3-4**, and confirm that the power level at each point is within limits.

Table 3-4 Output Power with Modulation

N5172B/82B Output Power with Modulation		
Frequency (MHz)	Amplitude (dBm)	Limits (dB)
250	7	±2
323	7	±2
512	7	±2
814	7	±2
1275	7	±2
2025	7	±2
2750	7	±2
3750	7	±2
5250	7	±2

N5172B/82B Alternative Test Procedure

If a USB power sensor is not available, use a power meter to measure the output power of the signal generator.

Test Setup

1. Zero and calibrate the power sensor to the power meter:

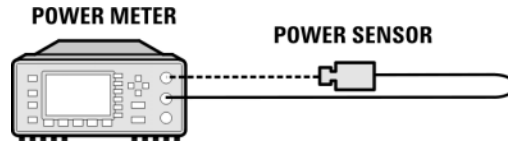

2. Connect the equipment as shown below:

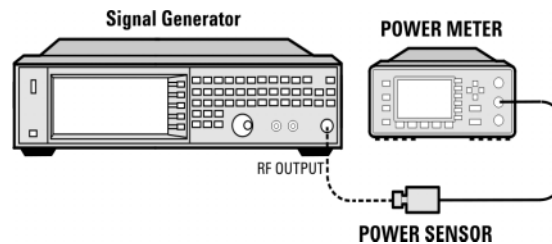

3. Preset the signal generator: Press **Preset**.
4. Turn RF on: Press **RF On/Off** so that the RF On/Off LED lights.
5. Turn modulation off:
Press **Mod On/Off** so that the Mod On/Off LED turns off.
6. Continue the procedure from **“Without Modulation”** on page 30.
7. Continue the procedure from **“With Modulation”** on page 31 to complete the output power measurements of the N5172B/82B.

N5173B/83B Test Procedure

Test Setup 1. Connect the equipment as shown:

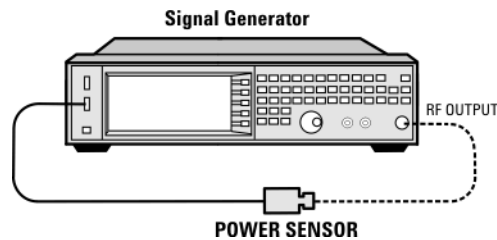

2. Zero and calibrate the power sensor.

NOTE USB U2000A Series Power Sensors do not require the sensor to be zeroed or calibrated.

3. Connect the power sensor to the RF output of the signal generator. Once the LED on the power sensor turns off, the sensor is ready to measure.
4. Preset the signal generator: Press **Preset**
5. Turn the internal power meter channel on: Press **Aux Fctn** > **Power Meter Measurements** > **Channel A On** (or **Channel B On**).
6. Turn RF on: Press **RF On/Off** so that the **RF On/Off** LED lights.
7. Turn modulation off: Press **Mod On/Off** so that the **Mod On/Off** LED turns off.
8. Set the frequency: Press **Frequency** and enter the first frequency value listed in [Table 3-6](#).
9. Set the amplitude: Press **Amplitude** and enter the amplitude value for that frequency.
10. Measure the output power level.
11. Repeat steps 8 through 10 to measure power at each of the frequencies listed in [Table 3-6](#).
12. Confirm that the measured power levels are within the limits listed in the table.

N5173B/83B Alternative Test Procedure

If a USB power sensor is not available, use a power meter to measure the output power of the signal generator.

Test Setup

1. Zero and calibrate the power sensor to the power meter:

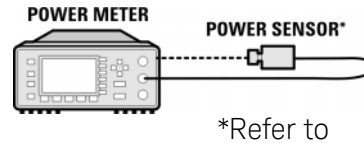

2. Connect the equipment as shown:

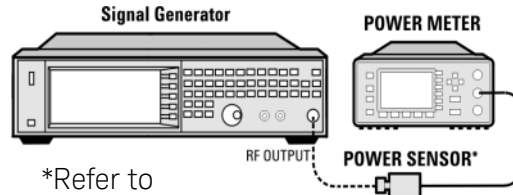

3. Preset the signal generator: Press **Preset**.
4. Turn RF on: Press **RF On/Off** so that the **RF On/Off** LED lights.
5. Turn modulation off: Press **Mod On/Off** so that the **Mod On/Off** LED turns off.
6. Set the frequency: Press **Frequency** and enter the first frequency value listed in [Table 3-6](#).
7. Set the amplitude: Press **Amplitude** and enter the amplitude value for that frequency.
8. Configure the power meter for the measurement.
 - a. Press the **Frequency Cal Fac** button on the power meter.
 - b. Select a power meter channel (if applicable).
 - c. Use the arrow keys to enter the frequency at which to measure the power.
9. Measure the output power level.
10. Repeat steps 6 through 9 to measure power at each of the 15 frequencies listed in [Table 3-6](#).
11. Confirm that the measured power levels are within the limits listed in the table.

Table 3-5 Power Sensors by Frequency and Options

N5173B/83B	Frequency	Power Sensor
Option 513/520/540	< 5GHz	E9304A
Option 520	> 5GHz	8485A
Option 532/540	> 5GHz	8487A

Table 3-6 Leveled Output Power Limits

N5173B/83B Output Power					
Frequency	Amplitude (dBm) Standard Power		Amplitude (dBm) Option 1EA		Limits ^{ab} (dB)
	513/520	532/540	513/520	532/540	
200 MHz	11	7	15	14	±2
300 MHz	11	7	15	14	±2
500 MHz	11	7	15	14	±2
800 MHz	11	7	15	14	±2
1.0 GHz	11	7	15	14	±2
2.0 GHz	11	7	15	14	±2
3.1 GHz	11	7	15	14	±2
5.0 GHz	11	7	18	14	±2
10 GHz	11	7	18	14	±2
20 GHz (Option 520)	--	7	--	13	±2
31.8 GHz (Option 532)	--	7	--	13	±2
40 GHz (Option 540)	--	7	--	12	±2

- a. Limit values are due to power meter uncertainty.
- b. For questions around measurement uncertainty, refer to the **Data Sheet**.

Troubleshooting Problems with the Output Power Check

- Verify that you are using the appropriate power sensor.
- Normally, power sensor calibration factors are automatically downloaded to the power meter when the power meter turns on. If this does not occur, manually enter the correct calibration factors for the power sensor you are using.
- Verify that the power sensor is properly calibrated to the power meter.

Operation Verification
Checking the Output Power

4 Regulatory Information

Certification

Keysight Technologies certifies that this product met its published specifications at the time of shipment from the factory. Keysight Technologies further certifies that its calibration measurements are traceable to the United States National Institute of Standards and Technology, to the extent allowed by the Institute's calibration facility, and to the calibration facilities of other International Standards Organization members.

Assistance

Product maintenance agreements and other customer assistance agreements are available for Keysight Technologies products. For assistance, contact Keysight Technologies (see [page 19](#)).

Statement of Compliance

This product(s) complies with applicable Safety and EMC regulations and directives. A copy of the manufacturer's Declaration of Conformity for this product(s) can be obtained by contacting your local Keysight Technologies sales representative.

Compliance with Canadian EMC Requirements

This ISM device complies with Canadian ICES-001.

Cet appareil ISM est conforme a la norme NMB du Canada.

Compliance with European Machinery Directive Acoustic Requirement

Table 4-1

Acoustic statement (European Machinery Directive 2002/42/EC, 1.7.4.2u)

Acoustic noise emission

$L_{pA} < 70$ dB

Operator position

Normal operation mode

5 Open Source Licenses

This chapter contains the licenses for open source software used in the Keysight MXG and EXG X-Series signal generators.

Apple mDNSResponder

Apache License

Version 2.0, January 2004

<http://www.apache.org/licenses/>

TERMS AND CONDITIONS FOR USE, REPRODUCTION, AND DISTRIBUTION

1. Definitions.

"License" shall mean the terms and conditions for use, reproduction, and distribution as defined by Sections 1 through 9 of this document.

"Licensor" shall mean the copyright owner or entity authorized by the copyright owner that is granting the License.

"Legal Entity" shall mean the union of the acting entity and all other entities that control, are controlled by, or are under common control with that entity. For the purposes of this definition, "control" means (i) the power, direct or indirect, to cause the direction or management of such entity, whether by contract or otherwise, or (ii) ownership of fifty percent (50%) or more of the outstanding shares, or (iii) beneficial ownership of such entity.

"You" (or "Your") shall mean an individual or Legal Entity exercising permissions granted by this License.

"Source" form shall mean the preferred form for making modifications, including but not limited to software source code, documentation source, and configuration files.

"Object" form shall mean any form resulting from mechanical transformation or translation of a Source form, including but not limited to compiled object code, generated documentation, and conversions to other media types.

"Work" shall mean the work of authorship, whether in Source or

Object form, made available under the License, as indicated by a copyright notice that is included in or attached to the work (an example is provided in the Appendix below).

"Derivative Works" shall mean any work, whether in Source or Object form, that is based on (or derived from) the Work and for which the editorial revisions, annotations, elaborations, or other modifications represent, as a whole, an original work of authorship. For the purposes of this License, Derivative Works shall not include works that remain separable from, or merely link (or bind by name) to the interfaces of, the Work and Derivative Works thereof.

"Contribution" shall mean any work of authorship, including the original version of the Work and any modifications or additions to that Work or Derivative Works thereof, that is intentionally submitted to Licensor for inclusion in the Work by the copyright owner or by an individual or Legal Entity authorized to submit on behalf of the copyright owner. For the purposes of this definition, "submitted" means any form of electronic, verbal, or written communication sent to the Licensor or its representatives, including but not limited to communication on electronic mailing lists, source code control systems, and issue tracking systems that are managed by, or on behalf of, the Licensor for the purpose of discussing and improving the Work, but excluding communication that is conspicuously marked or otherwise designated in writing by the copyright owner as "Not a Contribution."

"Contributor" shall mean Licensor and any individual or Legal Entity on behalf of whom a Contribution has been received by Licensor and subsequently incorporated within the Work.

2. Grant of Copyright License. Subject to the terms and conditions of this License, each Contributor hereby grants to You a perpetual, worldwide, non-exclusive, no-charge, royalty-free, irrevocable

copyright license to reproduce, prepare Derivative Works of, publicly display, publicly perform, sublicense, and distribute the Work and such Derivative Works in Source or Object form.

3. Grant of Patent License. Subject to the terms and conditions of this License, each Contributor hereby grants to You a perpetual, worldwide, non-exclusive, no-charge, royalty-free, irrevocable (except as stated in this section) patent license to make, have made, use, offer to sell, sell, import, and otherwise transfer the Work, where such license applies only to those patent claims licensable by such Contributor that are necessarily infringed by their Contribution(s) alone or by combination of their Contribution(s) with the Work to which such Contribution(s) was submitted. If You institute patent litigation against any entity (including a cross-claim or counterclaim in a lawsuit) alleging that the Work or a Contribution incorporated within the Work constitutes direct or contributory patent infringement, then any patent licenses granted to You under this License for that Work shall terminate as of the date such litigation is filed.

4. Redistribution. You may reproduce and distribute copies of the Work or Derivative Works thereof in any medium, with or without modifications, and in Source or Object form, provided that You meet the following conditions:

(a) You must give any other recipients of the Work or Derivative Works a copy of this License; and

(b) You must cause any modified files to carry prominent notices stating that You changed the files; and

(c) You must retain, in the Source form of any Derivative Works that You distribute, all copyright, patent, trademark, and

attribution notices from the Source form of the Work,
excluding those notices that do not pertain to any part of
the Derivative Works; and

(d) If the Work includes a "NOTICE" text file as part of its
distribution, then any Derivative Works that You distribute must
include a readable copy of the attribution notices contained
within such NOTICE file, excluding those notices that do not
pertain to any part of the Derivative Works, in at least one
of the following places: within a NOTICE text file distributed
as part of the Derivative Works; within the Source form or
documentation, if provided along with the Derivative Works; or,
within a display generated by the Derivative Works, if and
wherever such third-party notices normally appear. The contents
of the NOTICE file are for informational purposes only and
do not modify the License. You may add Your own attribution
notices within Derivative Works that You distribute, alongside
or as an addendum to the NOTICE text from the Work, provided
that such additional attribution notices cannot be construed
as modifying the License.

You may add Your own copyright statement to Your modifications and
may provide additional or different license terms and conditions
for use, reproduction, or distribution of Your modifications, or
for any such Derivative Works as a whole, provided Your use,
reproduction, and distribution of the Work otherwise complies with
the conditions stated in this License.

5. Submission of Contributions. Unless You explicitly state otherwise,
any Contribution intentionally submitted for inclusion in the Work
by You to the Licensor shall be under the terms and conditions of
this License, without any additional terms or conditions.

Notwithstanding the above, nothing herein shall supersede or modify

the terms of any separate license agreement you may have executed with Licensor regarding such Contributions.

6. Trademarks. This License does not grant permission to use the trade names, trademarks, service marks, or product names of the Licensor, except as required for reasonable and customary use in describing the origin of the Work and reproducing the content of the NOTICE file.
7. Disclaimer of Warranty. Unless required by applicable law or agreed to in writing, Licensor provides the Work (and each Contributor provides its Contributions) on an "AS IS" BASIS, WITHOUT WARRANTIES OR CONDITIONS OF ANY KIND, either express or implied, including, without limitation, any warranties or conditions of TITLE, NON-INFRINGEMENT, MERCHANTABILITY, or FITNESS FOR A PARTICULAR PURPOSE. You are solely responsible for determining the appropriateness of using or redistributing the Work and assume any risks associated with Your exercise of permissions under this License.
8. Limitation of Liability. In no event and under no legal theory, whether in tort (including negligence), contract, or otherwise, unless required by applicable law (such as deliberate and grossly negligent acts) or agreed to in writing, shall any Contributor be liable to You for damages, including any direct, indirect, special, incidental, or consequential damages of any character arising as a result of this License or out of the use or inability to use the Work (including but not limited to damages for loss of goodwill, work stoppage, computer failure or malfunction, or any and all other commercial damages or losses), even if such Contributor has been advised of the possibility of such damages.
9. Accepting Warranty or Additional Liability. While redistributing the Work or Derivative Works thereof, You may choose to offer, and charge a fee for, acceptance of support, warranty, indemnity,

or other liability obligations and/or rights consistent with this License. However, in accepting such obligations, You may act only on Your own behalf and on Your sole responsibility, not on behalf of any other Contributor, and only if You agree to indemnify, defend, and hold each Contributor harmless for any liability incurred by, or claims asserted against, such Contributor by reason of your accepting any such warranty or additional liability.

END OF TERMS AND CONDITIONS

WCELIBCEX - Windows CE C Library Extensions

The source code of the WCELIBCEX library is licensed under MIT License:

<http://opensource.org/licenses/mit-license.php>

Permission is hereby granted, free of charge, to any person obtaining a copy of this software and associated documentation files (the "Software"), to deal in the Software without restriction, including without limitation the rights to use, copy, modify, merge, publish, distribute, sublicense, and/or sell copies of the Software, and to permit persons to whom the Software is furnished to do so, subject to the following conditions:

The above copyright notice and this permission notice shall be included in all copies or substantial portions of the Software.

THE SOFTWARE IS PROVIDED "AS IS", WITHOUT WARRANTY OF ANY KIND, EXPRESS OR IMPLIED, INCLUDING BUT NOT LIMITED TO THE WARRANTIES OF MERCHANTABILITY, FITNESS FOR A PARTICULAR PURPOSE AND NONINFRINGEMENT. IN NO EVENT SHALL THE AUTHORS OR COPYRIGHT HOLDERS BE LIABLE FOR ANY CLAIM, DAMAGES OR OTHER LIABILITY, WHETHER IN AN ACTION OF CONTRACT, TORT OR OTHERWISE, ARISING FROM, OUT OF OR IN CONNECTION WITH THE SOFTWARE OR THE USE OR OTHER DEALINGS IN THE SOFTWARE.

Open Source Licenses
WCELIBCEX - Windows CE C Library Extensions

Index

A**AC**

- power cord, connecting 11
- symbol 3

accessories 15

address, GPIB 14

alcohol, cleaning with 17

altitude requirements 9

Australian Communications Authority (C-tick) mark 3

auto-IP 13

B

brightness adjustment 12

C

Canadian

- EMC requirements 39

- Standards Association (CSA) mark 3

cautions 1

certification 39, 42

checking the shipment 7

cleaning suggestions 17

contrast adjustment 12

D

DHCP 13

dimensions, signal generator 8

display adjustment 12

documentation v

documentation, ordering 15

E

European Community (CE) trademark 3

F

frequency accuracy check 24

frequency range and accuracy check 24

FTP server 14

G

German noise requirements 40

GPIB address, setting 14

guides v

H

hostname, setting 13

humidity requirements 9

I

ICES symbol 3

ICES-001 39

IEC Publication 61010 39, 49

inspection, shipping container 7

installation guide v

instrument warm up 21

interface, GPIB 14

interface, LAN 13

IP address, setting 13

ISM1-A symbol 3

K

Keysight, contacting 19

L

LAN configuration 13

line setting requirements 10

LXI standard specifications symbol 3

M

manuals, ordering 15

N

noise requirements 40

O

operation verification 21

operation, remote 13

output power, checking 26

P

power

- checking 26

- connecting 11

- disconnecting 11

- line cord 11

- requirements 10

- symbol 3

programming 13

programming guide v

R

references v

regulatory information 39, 41

remote operation 13

requirements 9, 10, 40

returning a signal generator 17

S

- safety information [1](#)
- SCPI reference [v](#)
- SCPI, enabling [14](#)
- self test [22](#)
- server, enabling [14](#)
- service
 - guide [v](#)
- service, Keysight sales and service offices [19](#)
- shipping container, inspection [7](#)
- shipping requirements [17](#)
- sockets, enabling [14](#)
- standby symbol [3](#)

T

- temperature requirements [9](#)
- troubleshooting output power [26](#)

U

- user
 - documentation [v](#)

V

- ventilation requirements [10](#)
- verification, operation [21](#)
- voltage requirements [10](#)
- VXI-11, enabling [14](#)

W

- warnings [1](#)
- web server [14](#)
- weight, signal generator [8](#)