

Keysight 8169A Polarization Controller

NOTICE: This document contains references to Agilent Technologies. Agilent's former Test and Measurement business has become Keysight Technologies. For more information, go to www.keysight.com.



Notices

© Keysight Technologies 2002 - 2015
This document contains proprietary information that is protected by copyright. All rights are reserved.

No part of this document may reproduced in (including electronic storage and retrieval or translation into a foreign language) without prior agreement and written consent from Keysight Technologies GmbH as governed by United States and international copyright laws.

Keysight Technologies Deutschland GmbH
Herrenberger Str. 130
71034 Böblingen
Germany

Manual Part Number

08169-90A01

Edition

Edition 3, April 2015

Edition 2, November 2004

Edition 1, September 1994

Warranty

This Keysight Technologies instrument product is warranted against defects in material and workmanship for a period of one year from date of shipment. During the warranty period, Keysight will, at its option, either repair or replace products that prove to be defective.

For warranty service or repair, this product must be returned to a service facility designated by Keysight. Buyer shall prepay shipping charges to Keysight and Keysight shall pay shipping charges to return the product to Buyer. However, Buyer shall pay all shipping charges, duties, and taxes for products returned to Keysight from another country.

Keysight warrants that its software

and firmware designated by Keysight for use with an instrument will execute its programming instructions when properly installed on that instrument. Keysight does not warrant that the operation of the instrument, software, or firmware will be uninterrupted or error free.

Limitation of Warranty

The foregoing warranty shall not apply to defects resulting from improper or inadequate maintenance by Buyer, Buyer-supplied software or interfacing, unauthorized modification or misuse, operation outside of the environmental specifications for the product, or improper site preparation or maintenance.

No other warranty is expressed or implied. Keysight Technologies specifically disclaims the implied warranties of Merchantability and Fitness for a Particular Purpose.

Exclusive Remedies

The remedies provided herein are Buyer's sole and exclusive remedies. Keysight Technologies shall not be liable for any direct, indirect, special, incidental, or consequential damages whether based on contract, tort, or any other legal theory.

Assistance

Product maintenance agreements and other customer assistance agreements are available for Keysight Technologies products. For any assistance contact your nearest Keysight Technologies Sales and Service Office.

Certification

Keysight Technologies certifies that this product met its published specifications at the time of shipment

from the factory.

Keysight Technologies further certifies that its calibration measurements are traceable to the United States National Institute of Standards and Technology, NIST to the extent allowed by the Institutes's calibration facility, and to the calibration facilities of other International Standards Organization members.

ISO 9001 Certification

Produced to ISO 9001 international quality system standard as part of our objective of continually increasing customer satisfaction through improved process control.

Safety Notices

CAUTION

A CAUTION notice denotes a hazard. It calls attention to an operating procedure, practice, or the like that, if not correctly performed or adhered to, could result in damage to the product or loss of important data. Do not proceed beyond a CAUTION notice until the indicated conditions are fully understood and met.

WARNING

A WARNING notice denotes a hazard. It calls attention to an operating procedure, practice, or the like that, if not correctly performed or adhered to, could result in personal injury or death. Do not proceed beyond a WARNING notice until the indicated conditions are fully understood and met.

Warnings and Notices

WARNING

To avoid the possibility of injury or death, you must observe the following precautions before switching on the instrument. Insert the power cable plug only into a socket provided with a protective ground contact. Do not negate this protective action by using an extension cord without a protective conductor.

WARNING

Never look directly into the end of a fiber or a connector, unless you are absolutely certain that there is no signal in the fiber.

Keysight Technologies Sales and Service Offices

For more information about Keysight Technologies test and measurement products, applications, services, and for a current sales office listing, visit our web site:

www.keysight.com/find/lightwave

You can also contact one of the following centers and ask for a test and measurement sales representative.

United States:	1 800 452 4844 1 888 900 8921 (FAX)
Canada:	1 877 894 4414 (905) 282 6495 (FAX)
Europe:	(31 20) 547 2111 (43 20) 547 2190 (FAX)
Japan:	0120 421 345 0120 421 678 (FAX)
Mexico	(52 55) 5081 9469 (52 55) 5081 9467 (FAX)
Australia:	1 800 629 485 1 800 142 134 (FAX)
Asia-Pacific:	(852) 3197 7889 (852) 2506 9233 (FAX)
Brazil	(55 11) 4197 3600 (55 11) 4197 3800 (FAX)

Contents

Getting Started	11
<hr/>	
General Safety Considerations	12
The Basic Operating Principle	14
Using the Polarization Controller for Polarization Analysis	15
Editing	16
Editing Using the Entry Keys	17
Editing Using the Modify Keys and Knob	17
Resetting Parameters	18
Setting a State of Polarization	19
<hr/>	
Setting up the Hardware	20
Setting the Position of the Polarizing Filter	21
Setting the State of Polarization	22
Positioning the $\lambda/4$ and $\lambda/2$ Retarder Plates	23
Using the Circle Mode	23
Example: Setting the Optimum Transmission SoP	24
Set the Polarizing Filter.	25
Setting the Worst Case Transmission SoP	26
Setting the Optimum Transmission SoP	28
Scanning the Poincare Sphere	29
<hr/>	
Setting up the Hardware	30
Setting Up and Executing a Scan	31
Example: Measuring the Response to a "Depolarized" Signal	32
Set the Polarizing Filter	33
Setting Up the Instruments	34
Running the Scan	34
Example: Measuring a Polarization Dependent Loss	35
Set the Polarizing Filter	36
Setting Up the Instruments	37
Running the Scan	37

Analyzing the Results	37
Other Front Panel Functions	39
<hr/>	
Setting the GPIB Address	40
Storing or Recalling Instrument Settings	40
Storing a Setting	40
Recalling a Setting	40
Resetting the Instrument	40
Programming the Polarization Controller	41
<hr/>	
GPIB Interface	42
Setting the GPIB Address	43
Returning the Instrument to Local Control	43
How the Polarization Controller Receives and Transmits Messages	44
How the Input Queue Works	44
Clearing the Input Queue	44
The Output Queue	45
The Error Queue	45
Some Notes about Programming and Syntax Diagram Conventions	45
Short Form and Long Form	46
Command and Query Syntax	47
Remote Commands	49
<hr/>	
Command Summary	52
The Common Commands	54
Common Status Information	55
SRQ, The Service Request	56
Switching On and Off the Instrument Display	66
Positioning the Polarizing Filter	67
Setting the State of Polarization	69
Scanning the Poincare Sphere	73
STATus Commands	75
Setting Up the STATus Registers	76
Checking the Status	81
SYSTEM Commands	84

Programming Examples	85
Example 1 - Checking Communication	86
Example 2 - Status Registers and Queues	87
Example 3 - Finding the Optimum Transmission SoP	90
Example 4 - Finding the Polarization Dependence	94
Installation	97
Safety Considerations	98
Initial Inspection	98
AC Line Power Supply Requirements	99
Line Power Cable	99
Replacing the Fuse	101
Replacing the Battery	102
Operating and Storage Environment	102
Temperature	102
Humidity	103
Altitude	103
Installation Category and Pollution Degree	103
Instrument Positioning and Cooling	103
Switching on the Polarization Controller	104
Optical Output	104
Trigger Input and Output	104
GPIB Interface	105
Connector	105
GPIB Logic Levels	106
Claims and Repackaging	106
Return Shipments to Keysight	107
Accessories	109
Instrument and Options	110
GPIB Cables and Adapters	110
Connector Interfaces and Other Accessories	110
Option 021, Straight Contact Connector	111
Option 022, Angled Contact Connector	112
Specifications	113
Introduction	114
Other Specifications	115

Declaration of Conformity	116
Performance Test	117
<hr/>	
Introduction	118
Insertion Loss Variation with Rotation of $\lambda/4$ and $\lambda/2$ Plates	119
Insertion Loss versus Wavelength	123
Extinction Ratio of Polarizer	127
Cleaning Information	133
<hr/>	
Safety Precautions	135
Why is it important to clean optical devices?	136
What materials do I need for proper cleaning?	137
Preserving Connectors	142
Cleaning Instrument Housings	143
General Cleaning Procedure	144
Additional Cleaning Information	156
Other Cleaning Hints	159
Error Messages	161
<hr/>	
Display Messages	162
GPIB Messages	163

1

Getting Started

This chapter describes the basic operating principle, and the basic operating of the polarization controller.

General Safety Considerations	12
The Basic Operating Principle	14
Using the Polarization Controller for Polarization Analysis. 15	
Editing	16
Editing Using the Entry Keys	17
Editing Using the Modify Keys and Knob	17
Resetting Parameters	18

General Safety Considerations

This product has been designed and tested in accordance with the standards listed on the Manufacturer's Declaration of Conformity, and has been supplied in a safe condition. The documentation contains information and warnings that must be followed by the user to ensure safe operation and to maintain the product in a safe condition.

Safety Symbols

CAUTION

The *caution* sign denotes a hazard. It calls attention to a procedure which, if not correctly performed or adhered to, could result in damage to or destruction of the product. Do not proceed beyond a caution sign until the indicated conditions are fully understood and met.

WARNING

The *warning* sign denotes a hazard. It calls attention to a procedure which, if not correctly performed or adhered to, could result in injury or loss of life. Do not proceed beyond a warning sign until the indicated conditions are fully understood and met.

Instrument Markings

-  The instruction manual symbol. The product is marked with this warning symbol when it is necessary for the user to refer to the instructions in the manual.

-  The laser radiation symbol. This warning symbol is marked on products which have a laser output.

-  The AC symbol is used to indicate the required nature of the line module input power.

-  The ON symbols are used to mark the positions of the instrument power line switch.

-  The OFF symbols are used to mark the positions of the instrument power line switch.

-  The CE mark is a registered trademark of the European Community.

-  The CSA mark is a registered trademark of the Canadian Standards Association.

-  The C-Tick mark is a registered trademark of the Australian Spectrum Management Agency.

- ISM1-A This text denotes the instrument is an Industrial Scientific and Medical Group 1 Class A product.

To return unwanted products, contact your local Keysight office, or see

<http://about.keysight.com/en/companyinfo/environment/takeback.shtml> for more information.

The Basic Operating Principle

The Keysight 8169A Polarization Controller transforms polarization relative to a built in linear polarizer.

This means that the optical input is passed through a linear polarizer (Pol), to extract a single linear polarization.

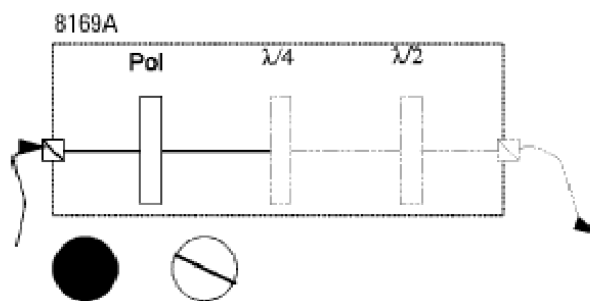

Figure 1 Block Diagram and Polarization States (non-polarized ! linear polarized)

You should position this plate to get the maximum from the incoming signal (attach a power meter to the output, and set the angle). The $\lambda/4$ and the $\lambda/2$ plates are then positioned to control the relative state of polarization of this signal.

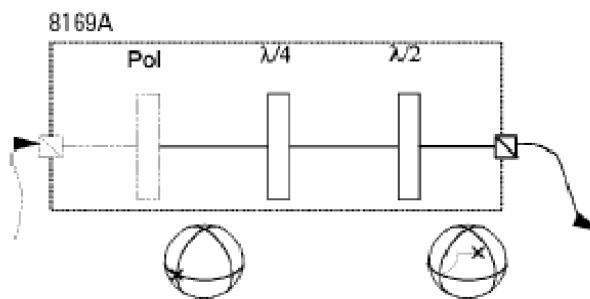

Figure 2 Block Diagram and Polarization States (non-polarized ! linear polarized)

You can either set the position of the plates directly, or use the circle application to set the $2\varepsilon_B$ and $2\theta_P$ angles that denote the position on the Poincaré Sphere. In addition, using the sphere application, you can vary the angles of the $\lambda/4$ and the $\lambda/2$ plates continuously. By varying the plate positions slowly, and sampling the response of your Device Under Test, you can find the maximum and minimum power levels, and thus make polarization dependent measurements. By varying the plate positions quickly, and averaging over all the states of polarization, you can measure the response of your DUT to a "depolarized" signal.

Using the Polarization Controller for Polarization Analysis

It is also possible to use the polarization controller to analyze the polarization of a signal. To do this you attach your incoming signal to the $\lambda/2$ connector, and attach your power meter to the Pol connector.

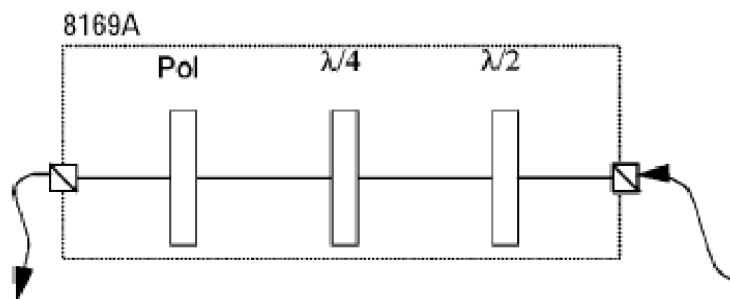

Figure 3 Block Diagram for Polarization Analysis

You analyze the signal by varying the $\lambda/4$ and $\lambda/2$ plates and the polariser filter, and examining how this affects the power. It is beyond the scope of this manual to explain this topic in detail.



Editing

You can edit a parameter by using

- the Entry keys,
- the Cursor/Vernier keys, or
- the Modify knob.

Editing Using the Entry Keys

- 1 Make sure the correct parameter is selected (the label of the selected parameter is displayed inverse).
- 2 Type in the new value.
- 3 Press .





If you mistype the number, you can move the cursor left and right using the Cursor keys ( and ).

If you want to abort editing, without changing the parameter, press

.

If the parameter changes back to its old value when you press , then the new value would be out of the range allowed for that parameter.

Editing Using the Modify Keys and Knob

- 1 Make sure the correct parameter is selected (the label of the selected parameter is displayed inverse).
- 2 Press any of the Cursor/Vernier keys, to activate editing.
- 3 Use the Cursor keys ( and ) to move to the first digit you want to edit.
- 4 Change the value using the Vernier keys ( and ) OR Change the value using the Modify knob.
- 5 Repeat steps list item 3 to list item 4 as often as necessary.
- 6 Press .

If you want to abort editing, without changing the parameter, press .

If you cannot change a digit with the Vernier keys or the Modify knob, this means that the new value would be out of the range allowed for the parameter.

Resetting Parameters

To reset any parameter

1 Make sure the correct parameter is selected (the label of the selected parameter is displayed inverse).

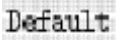
2 Press 

To reset Pol, $\lambda/4$, $\lambda/2$, $2 \epsilon_B$, AND $2 \theta_P$ simultaneously, press 

2

Setting a State of Polarization

This chapter describes the two ways of setting a State of Polarization,

- By positioning the polarizing filter, the $\lambda/2$, and the $\lambda/4$ plates.
- By positioning the polarizing filter and then specifying the desired position on the Poincare sphere.

Setting up the Hardware	20
Setting the Position of the Polarizing Filter	21
Setting the State of Polarization	22
Positioning the $\lambda/4$ and $\lambda/2$ Retarder Plates	23
Using the Circle Mode	23
Example: Setting the Optimum Transmission SoP	24
Set the Polarizing Filter.	25
Setting the Worst Case Transmission SoP	26
Setting the Optimum Transmission SoP	28

Setting up the Hardware

NOTE

When you are setting up your hardware, it is absolutely vital that the fibers are fixed, and remain unmoved for the whole of the measurement. Moving the fibers changes the state of polarization.

Typically, you will connect the polarization controller directly after your source, and before your device under test (DUT). Before connecting to the rest of your measurement setup, you should set the position of the polarizing filter.

Setting the Position of the Polarizing Filter

The polarizing filter should be set to maximize the signal. This means aligning the polarizing filter with the greatest linear polarization of the source. (Light from laser sources is elliptically polarized).

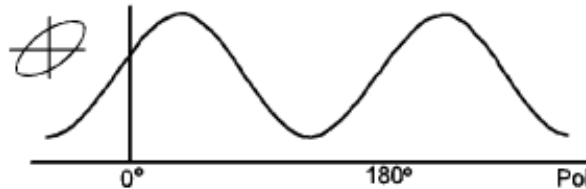

Figure 4 Power as a function of the angle of linear polarization for laser light

- 1** Connect the output of the polarization controller to a power meter.
- 2** With all the instruments turned on, press **Home** on the polarization controller. This resets the positions of all the plates.
- 3** Select the polarization filter. You may need to press **Pol** and/or **Pol** if the filter is not already selected.
- 4** Move the filter to find the maximum signal through the polarization controller. One way of doing this is
 - a** Press the right Cursor key twice to select the units digit.
 - b** Watching the power meter, and using the Modify knob, adjust the angle of the polarization filter, until you are in the area of one of the maxima.
 - c** Select the tenths digit.
 - d** Watching the power meter, and using the Modify knob, adjust the angle of the polarization filter, until you find the maximum.
 - e** Select the hundredths digit, and adjust the angle of the polarization filter if necessary to get the absolute maximum.
- 5** Disconnect the power meter, and connect to your DUT, and the rest of your measurement setup, making sure to move the fibers as little as possible.

Setting the State of Polarization

The state of polarization of a signal can be described by a position on the Poincare sphere. This position can be expressed in spherical coordinates by two angles, called ϵ_B and θ_p .

- θ_p is the optical angle about the 'equator' of the sphere (that is, $2\theta_p$ is the angle of 'longitude').
- ϵ_B is half the angle of elevation from the equatorial plane (that is, $2\epsilon_B$ is the angle of 'latitude').

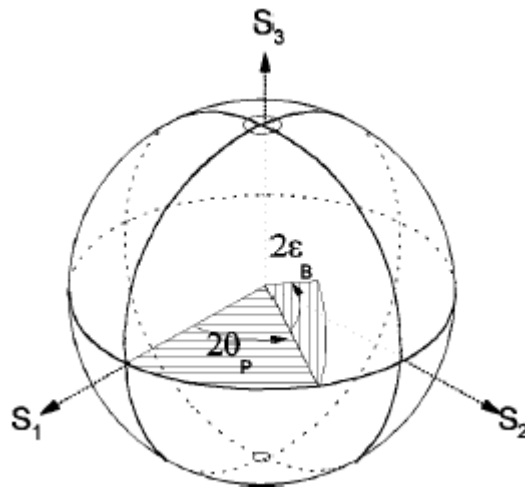

Figure 5 The coordinates for describing the state of polarization

The state of polarization is always relative to the output from the polarizing filter.

There are two ways of setting the state of polarization,

- by specifying the position of the $\lambda/4$ and $\lambda/2$ retarder plates, or
- by specifying ϵ_B and θ_p , the coordinates on the Poincare sphere.

Positioning the $\lambda/4$ and $\lambda/2$ Retarder Plates

You can set the state of polarization by positioning the $\lambda/4$, and $\lambda/2$ plates.

- 1 Select a retarder plate. You may need to press  first to get the display with the plates. Press $\lambda/4$ or $\lambda/2$ if the plate you want is not already selected.
- 2 Move the plate to the position you want. (See "Editing" in Chapter 1 if you need information on changing the angles).

Using the Circle Mode

You can set the state of polarization by specifying the coordinates on the Poincare sphere. See "Setting the State of Polarization" for an explanation. This mode assumes the polarizer is positioned at zero degrees.

- 1 Select an angle. You may need to press  first to get the display with the angles. Press $2 \varepsilon_B$ or $2 \theta_p$ if the angle you want is not already selected.
- 2 Change the angle to the value you want. (See "Editing" in Chapter 1 if you need information on changing the angles).

Example: Setting the Optimum Transmission SoP

To find the state of polarization which gives optimum transmission for a linear device under test (DUT), the steps are

- 1 Set the polarizing filter.
- 2 Find the state of polarization for worst case transmission (this is easier to find, because the resolution allows greater accuracy at lower power).
- 3 Set the state of polarization for optimum transmission.

For this example, you will need, apart from the polarization controller, a laser source, and a power meter (in the description below, a Keysight 8163B Lightwave Multimeter with a laser module and a sensor module are used). We will use the length of fiber connecting the instruments as our linear DUT.

- 1 With both instruments switched off, connect the laser source to the polarization controller.
- 2 Connect the polarization controller to the power meter.

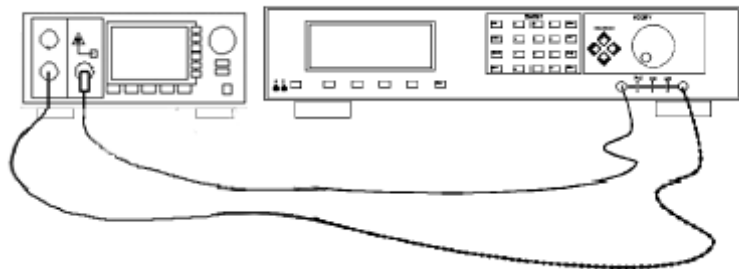







Figure 6 Setup for setting the position of the polarizing filter.

- 3 Switch on both instruments, and enable the laser source.
- 4 Set the channel with the sensor module to the wavelength of the source, and select the default averaging speed (200 ms).

NOTE

Under normal circumstances you should leave the instruments to warmup. (The multimeter needs around 20 minutes to warm up.) Warming up is necessary for accuracy of the sensor, and the output power of the source.

Set the Polarizing Filter.

- 1 Press  on the polarization controller.
- 2 Press .
- 3 Set the angle of the polarizing filter for maximum throughput.
 - a Type in 10 and press .
 - b Press  twice to select the tens digit.
 - c Using the Modify knob, increase the angle slowly until the power read on the multimeter increases and then starts to decrease.
 - d Press  once to select the units digit.
 - e Using the Modify knob, decrease the angle slowly until the power read on the multimeter starts to decrease.
 - f Press  twice to select the hundredths digit.

Using the Modify knob, increase the angle slowly until the power on the multimeter starts to decrease. Return to the angle that gave the maximum power.

Setting the Worst Case Transmission SoP

We set the state of polarization for the worst case transmission, because we can find this more accurately (the resolution of the power meter stays the same, but the full scale value is lower, therefore we can be more accurate). We also use the fact that the relationship between power of the signal transmitted through the DUT and polarization on the surface of the sphere can be expressed as concentric circles about the worst case (or optimum), and that for a linear DUT the worst case and optimum are on opposite sides of the sphere.

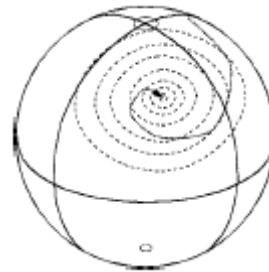

Figure 7 Power contours about the worst case on the poincare sphere

This means that we find the worst case position by moving around the sphere along the equator first (that is finding the angle of longitude of the worst case) and then the overall worst case by moving around this line of longitude.

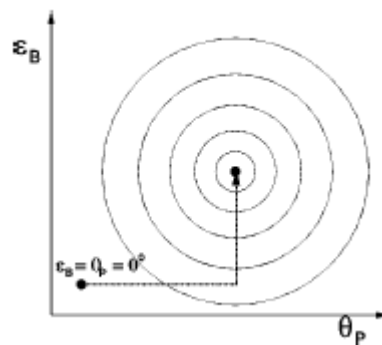



Figure 8 Power contours with a search path to the worst case transmission state of polarization

- 1 Press  , and θ_p , to select θ_p .
- 2 Search for the line of longitude with the minimum power (use a similar method as for the position of the polarizing filter; first changing the tens, then the units, then the hundredths).
- 3 Press ε_B , to select ε_B .
- 4 Search for the angle of latitude with the minimum power.

Setting the Optimum Transmission SoP

- 1 Read the value for ϵ_B from the display.
- 2 Add 180° to this value.
- 3 Type in the new value, and press .

The state of polarization is now set to the value for the current setup that gives the greatest power through the fiber. This is possible here because the fiber behaves linearly. For non-linear components the polarizations for worst case and optimum transmission will not be on opposite sides of the sphere, and the angle between them is a characteristic of the component.

3

Scanning the Poincare Sphere

This chapter describes how you can use your polarization controller to measure polarization dependence, and how you can generate quasi-depolarized signals.

Setting up the Hardware	30
Setting Up and Executing a Scan.....	31
Example: Measuring the Response to a "Depolarized" Signal	32
Set the Polarizing Filter	33
Setting Up the Instruments	34
Running the Scan	34
Example: Measuring a Polarization Dependent Loss . . .	35
Set the Polarizing Filter	36
Setting Up the Instruments	37
Running the Scan	37
Analyzing the Results	37

Setting up the Hardware

NOTE

When you are setting up your hardware, it is absolutely vital that the fibers are fixed, and remain unmoved for the whole of the measurement. Moving the fibers changes the state of polarization.

Typically, you will connect the polarization controller directly after your source, and before your device under test (DUT). Before connecting to the rest of your measurement setup, you should set the position of the polarizing filter (this is described in [Set the Polarizing Filter](#) in Chapter 2).

Setting Up and Executing a Scan

The sphere application changes the state of polarization over time, by rotating the $\lambda/2$ and $\lambda/4$ plates. The rotations can be done slowly, to give a quasi-randomly polarized signal, which you can use, with suitable data logging to measure polarization dependence. The rotations can be done quickly, to give a quasi-depolarized signal, which you can use, with suitable measurement averaging time to measure depolarized response.

1 Press **Sphere** to select the application.

NOTE

The Pol filter angle shown here is the same as the one shown when you press **Pos**. If you have already set this value, there is no need to change it.

2 Set the speed at which the λ plates rotate:

- Set Speed to Fast and the averaging time of your power meter to longer than 1s to get measure the response to depolarized signal. If it is not already selected:
 - a Move the Modify knob.
 - b Select Fast using the Modify knob **↓**, or **↑**.
 - c Press **Enter**, or **Select**.

- Set Speed to Slow and the averaging time of your power meter as short as possible, and use logging to measure polarization dependence. If it is not already selected:
 - d Move the Modify knob.
 - e Select Slow using the Modify knob **↓**, or **↑**.
 - f Press **Enter**, or **Select**.

3 When everything is setup, press **Exec** to start the scan.

During the scan, values for the angle of $\lambda/4$ and $\lambda/2$ are shown on the display. These values are samples. The λ plates rotate continuously.

Example: Measuring the Response to a "Depolarized" Signal

To measure the response to a "depolarized" signal for a device under test (DUT), the steps are

- 1 Set the polarizing filter.
- 2 Set the scanning speed to Fast.
- 3 Set the averaging time of the power meter.
- 4 Start the scan, and measure the value.

For this example, you will need, apart from the polarization controller, a laser source, and a power meter (in the description below, a Keysight 8163B Lightwave Multimeter with a laser module and a sensor module are used). A roll of fiber will act as a suitable DUT.

- 1 With both instruments switched off, connect the laser source to the polarization controller.
- 2 Connect the polarization controller to the power meter.

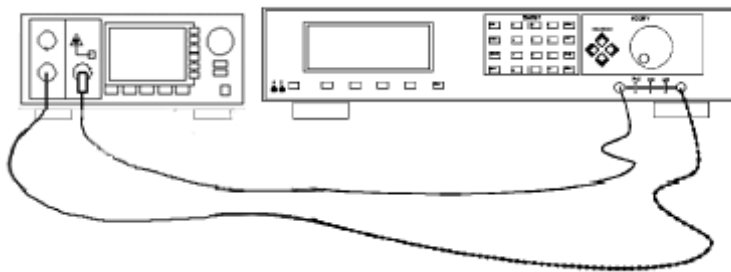

Figure 9 Setup for setting the position of the polarizing filter.

- 3 Switch on both instruments, and enable the laser source.

NOTE

Under normal circumstances you should leave the instruments to warmup. (The multimeter needs around 20 minutes to warm up.) Warming up is necessary for accuracy of the sensor, and the output power of the source.

- 4 Set the channel with the sensor module to the wavelength of the source, and select the default averaging speed (200 ms) [Press **Param** to select T, hold **Param** to reset T].

Set the Polarizing Filter

- 1 Press **Home** on the polarization controller.
- 2 Press **Pos**.
- 3 Set the angle of the polarizing filter for maximum throughput.
 - a Type in 10 and press **Enter**.
 - b Press **⇒** twice to select the tens digit.
 - c Using the Modify knob, increase the angle slowly until the power read on the multimeter increases and then starts to decrease.
 - d Press **⇒** once to select the units digit.
 - e Using the Modify knob, decrease the angle slowly until the power read on the multimeter starts to decrease.
 - f Press **⇒** twice to select the hundredths digit.
 - g Using the Modify knob, increase the angle slowly until the power on the multimeter starts to decrease. Return to the angle that gave the maximum power.
- 4 Connect the DUT into the setup, disturbing the setup as little as possible.

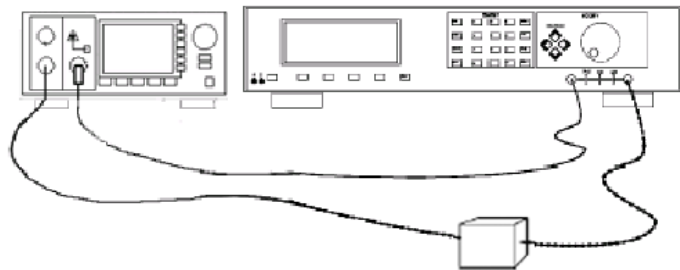









Figure 10 Setup with the DUT

Setting Up the Instruments

- 1 Run the sphere application with a fast scan.
 - a Press .
 - b Make sure that Speed is set to Fast. If it is not, then
 - Move the Modify knob to start the parameter selection.
 - Select Fast using the Modify knob, , or .
 - Press .
- 2 Set the averaging time on the power meter to 1s [Press  to select T, press  to increase T to 1s].

Running the Scan

- 1 Press  on the polarization controller.

There is a slight delay while the application is initialized, and then the values of $\lambda/4$ and $\lambda/2$ on the display begin to change.

- 2 When the application is running, read the value for the response of the DUT to a depolarized signal from the display for the power sensor.

Example: Measuring a Polarization Dependent Loss

To measure the sensitivity to polarization, apply a quasi-random polarization to the (DUT), the steps are

- 1 Set the polarizing filter.
- 2 Set the scanning speed to Slow.
- 3 Set the power meter to record.
- 4 Start the scan, and record the readings for different polarization states.
- 5 Analyze the results.

For this example, you will need, apart from the polarization controller, a laser source, and a power meter (in the description below, a Keysight 8163B Lightwave Multimeter with a laser module and a sensor module are used). A roll of fiber will act as a suitable DUT.

- 1 With both instruments switched of, connect the laser source to the polarization controller.
- 2 Connect the polarization controller to the power meter.

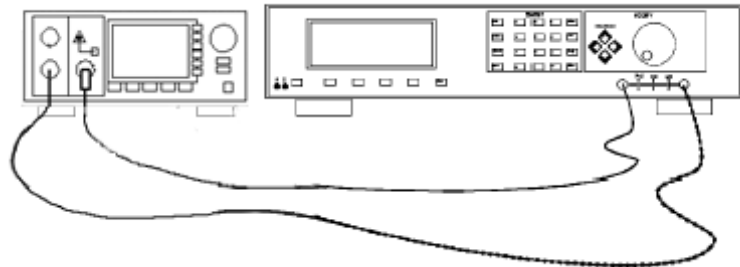

Figure 11 Setup for setting the position of the polarizing filter.

- 3 Switch on both instruments, and enable the laser source

NOTE

Under normal circumstances you should leave the instruments to warmup. (The multimeter needs around 20 minutes to warm up.) Warming up is necessary for accuracy of the sensor, and the output power of the source.

- 4 Set the channel with the sensor module to the wavelength of the source, and select the default averaging speed (200 ms) [Press **Param** to select T, hold **Param** to reset T].

Set the Polarizing Filter

- 1 Press **Home** on the polarization controller.
- 2 Press **Pos**.
- 3 Set the angle of the polarizing filter for maximum throughput.
 - a Type in 10 and press **Enter**.
 - b Press **⇒** twice to select the tens digit.
 - c Using the Modify knob, increase the angle slowly until the power read on the multimeter increases and then starts to decrease.
 - d Press **⇒** once to select the units digit.
 - e Using the Modify knob, decrease the angle slowly until the power read on the multimeter starts to decrease.
 - f Press **⇒** twice to select the hundredths digit
 - g Using the Modify knob, increase the angle slowly until the power on the multimeter starts to decrease. Return to the angle that gave the maximum power.
- 4 Connect the DUT into the setup, disturbing the setup as little as possible.

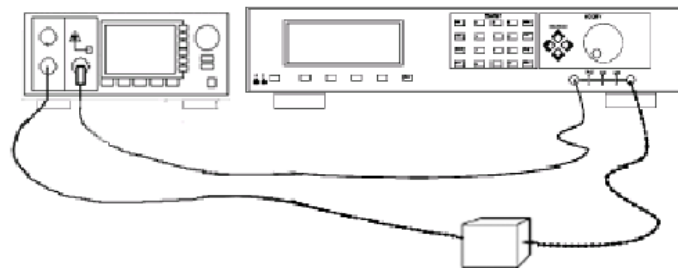

Figure 12 Setup with the DUT

Setting Up the Instruments

- 1 Run the sphere application with a fast scan.
 - a Press **Sphere**.
 - b Make sure that Speed is set to Slow. If it is not, then
 - i. Move the Modify knob to start the parameter selection.
 - ii. Select Fast using the Modify knob, **↓**, or **↑**.
 - iii. Press **Select**.
- 2 Set the averaging time on the power meter to 20 ms [Press **Param** to select T, press **↑** to increase T to 20 ms].
- 3 Set up a Stability measurement over 20 seconds [Press **Menu**, and **Record** to select STABILITY. Press **Edit** to select T TOTAL, and set it to 00:00:20, set AUTODUMP to OFF]

Running the Scan

- 1 Press **Exec** on the polarization controller.

There is a slight delay while the application is initialized, and then the values of $\lambda/4$ and $\lambda/2$ on the display begin to change.

- 2 When the application is running, read the value for the response of the DUT to a depolarised signal from the display for the power sensor.

Analyzing the Results

- 1 When the recording is finished look at the results and find the difference between the highest and lowest [Press **More** to get SHOW, press **Edit**, and then **Next** twice to get DIFF].

This is the Polarization Dependent Loss for the DUT.

4

Other Front Panel Functions

This chapter covers setting the GPIB address for the polarization controller, and storing and recalling instrument settings.

Setting the GPIB Address	40
Storing or Recalling Instrument Settings	40
Storing a Setting	40
Recalling a Setting	40
Resetting the Instrument	40

Setting the GPIB Address

You can see or edit the GPIB address of the instrument by pressing **System**. The default GPIB address is 24.

Storing or Recalling Instrument Settings

Press **System** and then **STO/RCL** to see the actual, current setting of the instrument, the default setting for the instrument, and the 9 stored settings for the instrument. View the various settings by using **Previous** and **Next**.

Storing a Setting

To store the actual instrument setting,

- 1 Find one of the nine numbered settings, which you can overwrite using **Previous** and **Next**.
- 2 Press **Store**.

Recalling a Setting

To recall a setting and make it the actual instrument setting,

- 1 Find the setting you want to restore, using **Previous** and **Next**.
- 2 Press **Recall**.

Resetting the Instrument

Resetting the instrument returns all the parameters to their default values (the polarization filter and both wavelength plates are reset to 0.00° and the speed for the sphere application is set to Fast).

To reset the instrument, you can either

- 1 Find the actual setting you want to restore, using **Previous** and **Next**.
 - 2 Press **Default**.
- or
- 1 Find the default setting, using **Previous** and **Next**.
 - 2 Press **Recall**.

5

Programming the Polarization Controller

This chapter gives general information on how to control the polarization controller remotely. Descriptions for the actual commands for the polarization controller are given in the following chapters. The information in these chapters is specific to the polarization controller.

GPIB Interface	42
Setting the GPIB Address.....	43
Returning the Instrument to Local Control.....	43
How the Polarization Controller Receives and Transmits Messages	44
How the Input Queue Works	44
Clearing the Input Queue	44
The Output Queue	45
The Error Queue	45
Some Notes about Programming and Syntax Diagram Conventions	45
Short Form and Long Form	46
Command and Query Syntax	47

GPIB Interface

The interface used by your instrument is the GPIB (General Purpose Interface Bus).

GPIB is the interface used for communication between a controller and an external device, such as the tunable laser source. The GPIB conforms to IEEE standard 488-1978, ANSI standard MC 1.1 and IEC recommendation 625-1.

If you are not familiar with the GPIB, then refer to the following books:

- The International Institute of Electrical and Electronics Engineers. *IEEE Standard 488.1-1987, IEEE Standard Digital Interface for Programmable Instrumentation.*
- The International Institute of Electrical and Electronics Engineers. *IEEE Standard 488.2-1987, IEEE Standard Codes, Formats, Protocols and Common Commands For Use with ANSI/IEEE Std 488.1-1987.*

To obtain a copy of either of these last two documents, look at:

http://standards.ieee.org/findstds/standard/instrumentation_and_measurement.html

In addition, the commands not from the IEEE-488.2 standard, are defined according to the Standard Commands for Programmable Instruments (SCPI).

For information about SCPI, and SCPI programming techniques, please refer to:

- Standard Commands for Programmable Instruments:
Web: <http://www.ivifoundation.org/docs/scpi-99.pdf>
See also: <http://www.ivifoundation.org/scpi/>

The interface of the 8163A/B Lightwave Multimeter, 8164A/B Lightwave Measurement System, and 8166A/B Lightwave Multichannel System to the GPIB is defined by the IEEE Standards 488.1 and 488.2.

Table 1 shows the interface functional subset that the instruments implement.

Table 1 GPIB Capabilities

Mnemonic	Function
SH1	Complete source handshake capability
AH1	Complete acceptor handshake capability
T6	Basic talker; serial poll; no talk only mode; unaddressed to talk if addressed to listen
L4	Basic listener; no listen only mode; unaddressed to listen if addressed to talk
SR1	Complete service request capability
RL1	Complete remote/local capability
PP0	No parallel poll capability
DC1	Complete device clear capability
DT0	No device trigger capability
C0	No controller capability.

Setting the GPIB Address

You can only set the GPIB address from the front panel. See "Setting the GPIB Address" in Chapter 4.

The default GPIB address is 24.

Returning the Instrument to Local Control

If the instrument has been operated in remote the only key you can use is `Local`. The `Local` key returns the instrument to local control. `Local` does not operate if local lockout has been enabled.

How the Polarization Controller Receives and Transmits Messages

The polarization controller exchanges messages using an input and an output queue. Error messages are kept in a separate error queue.

How the Input Queue Works

The input queue is a FIFO queue (first-in first-out). Incoming bytes are stored in the input queue as follows:

- 1 Receiving a byte:
 - a Clears the output queue.
 - b Clears Bit 7 (MSB).
- 2 No modification is made inside strings or binary blocks. Outside strings and binary blocks, the following modifications are made:
 - a Lower-case characters are converted to upper-case.
 - b The characters 0016 to 0916 and 0B16 to 1F16 are converted to spaces (2016).
 - c Two or more blanks are truncated to one.
- 3 An EOI (End Or Identify) sent with any character is put into the input queue as the character followed by a line feed (LF, 0A16). If EOI is sent with a LF, only one LF is put into the input queue.
- 4 The parser starts if the LF character is received or if the input queue is full.

Clearing the Input Queue

Switching the power off, or sending a Device Interface Clear signal, causes commands that are in the input queue, but have not been executed to be lost.

The Output Queue

The output queue contains responses to query messages. The polarization controller transmits any data from the output queue when a controller addresses the instrument as a talker.

Each response message ends with a LF (0A16), with EOI=TRUE. If no query is received, or if the query has an error, the output queue remains empty.

The Message Available bit (MAV, bit 4) is set in the Status Byte register whenever there is data in the output queue.

The Error Queue

The error queue is a FIFO queue (first-in first-out). That is, the first error read is the oldest error to have occurred.

If too many errors are put into the queue, the message '-350 <Queue Overow>' is placed as the last message in the queue.

Some Notes about Programming and Syntax Diagram Conventions

A program message is a message containing commands or queries that you send to the polarization controller. The following are a few points about program messages:

- You can use either upper-case or lower-case characters.
- You can send several commands in a single message. Each command must be separated from the next one by a semicolon (;).
- You end a program message with a line feed (LF) character, or any character sent with End-Or-Identify (EOI).

Short Form and Long Form

The instrument accepts messages in short or long forms. For example, the message `:DISPLAY:ENABLE ON` is in long form, the short form of this message is `DISP:ENAB ON`.

In this manual the messages are written in a combination of upper and lower case. Upper case characters are used for the short form of the message. For example, the above command would be written `:DISPlay:ENABle`.

The first colon can be left out for the first command or query in your message. That is, the example given above could also be sent as `DISP:ENAB ON`.

Command and Query Syntax

All characters not between angled brackets must be sent exactly as shown.

The characters between angled brackets (< . . . >) show the kind of data that you send, or that you get in a response. You do not type the angled brackets in the actual message. Descriptions of these items follow the syntax description. The most common of these are:

string	is ascii data. A string is contained between a " at the start and the end, or a ' at the start and the end.
value	is numeric data in integer (12), decimal (34.5) or exponential format (67.8E-9).
wsp	is a white space

Other kinds of data are described as required.

The characters between square brackets ([. . .]) show optional information that you can include with the message.

The bar (|) shows an either-or choice of data, for example, a|b means either a or b, but not both simultaneously.

Extra spaces are ignored; they can be inserted to improve readability.

6

Remote Commands

This chapter gives a list of the remote commands, for use with the GPIB.

In the remote command descriptions the parts given in upper-case characters must be given. The parts in lower-case characters can also be given, but they are optional.

Command Summary.....	52
The Common Commands.....	54
Common Status Information.....	55
SRQ, The Service Request.....	56
*CLS.....	56
*ESE.....	57
*ESE?.....	57
*ESR?.....	58
*IDN?.....	58
*OPC.....	59
*OPC?.....	59
*RCL.....	60
*RST.....	60
*SAV.....	61
*SRE.....	61
*SRE?.....	62
*STB?.....	62
*TST?.....	63
*WAI.....	64

Switching On and Off the Instrument Display	66
:DISPlay:ENABle	66
:DISPlay:ENABle?	66
Positioning the Polarizing Filter	67
[:INPut]:POSition:POLarizer	67
[:INPut]:POSition:POLarizer?	67
Setting the State of Polarization	69
[:INPut]:CIRClE:EPSilonb	69
[:INPut]:CIRClE:EPSilonb?	69
[:INPut]:CIRClE:THETap	70
[:INPut]:CIRClE:THETap?	70
[:INPut]:POSition:HALF?	71
[:INPut]:POSition:QUARter	72
[:INPut]:POSition:QUARter?	72
Scanning the Poincare Sphere	73
[:INPut]:PSPHere:RATE	73
[:INPut]:PSPHere:RATE?	73
:INITiate[:IMMediate].	73
ABORt	74
STATus Commands	75
Setting Up the STATus Registers	76
:STATus:PRESet	76
:STATus:OPERation:NTRansition	76
:STATus:OPERation:NTRansition?	77
:STATus:OPERation:PTRansition	77
:STATus:OPERation:PTRansition?	77
:STATus:OPERation:ENABle	77
:STATus:QUEStionable:NTRansition	78
:STATus:QUEStionable:NTRansition?	79
:STATus:QUEStionable:PTRansition	79
:STATus:QUEStionable:PTRansition?	79
:STATus:QUEStionable:ENABle	80
:STATus:QUEStionable:ENABle?	80

Checking the Status.....	81
:STATus:OPERation:CONDition?	81
:STATus:OPERation[:EVENT]?	81
:STATus:QUEStionable:CONDition?	82
:STATus:QUEStionable[:EVENT]?	83
SYSTem Commands	84
:SYSTem:ERRor?	84
:SYSTem:VERSion?	84

Command Summary

Table 2 Common Command Summary

Command Parameter/Response		Min	Max	Funktion
*CLS				Clear Status Command
*ESE	<value>	0	255	Standard Event Status Enable Command
*ESE?	<value>	0	255	Standard Event Status Enable Query
*ESR?	<value>	0	255	Standard Event Status Register Query
*IDN?	<string>			Identification Query
*OPC				Operation Complete Command
*OPC?	<value>			Operation Complete Query
*RCL	<location>	0	9	Recall Instrument Setting
*RST				Reset Command
*SAV	<location>	1		Save Instrument Setting
*SRE	<value>	0	255	Service Request Enable Command
*SRE?	<value>	0	255	Service Request Enable Query
*STB	<value>	0	255	Read Status Byte Query
*TST	<value>	0		Self Test Query
*WAI				Wait Command

Table 3

Command	Parameter Response	Unit	MINimum	MAXimum	DEFault
:ABORt					
:DISPlay	OFF 0 / ON 1				
:ENABle	0 / 1				
:ENABle?					
INITiate					
[:IMMediate]					
[:INPut)					
:CIRClE					
:EPSilonb	<value>	†	-720.00	720.00	0.00
:EPSilonb?	<value>	†			
:THETap	<value>	†	-2160.00	2160.00	0.00
:THETap?	<value>	†			
:POSition					
:HALF	<value>	†	-350.00	350.00	0.00
:HALF?	<value>	†			
:POLarizer	<value>	†	-360.00	360.00	0.00
:POLarizer?	<value>	†			
:QUARter	<value>	†	-360.00	360.00	0.00
:QUARter?	<value>	†			
:PSPHere					
:RATE	0 / 1		0	1	1
:RATE?	0 / 1				
:STATus					
:OPERation					
:CONDition?	<value>				
:ENABle	<value>		0	65535	0
:ENABle?	<value>				
[:ENVENT]?	<value>				
:NTRansmission	<value>		0	65535	0
:NTRansmission?	<value>				
:PTRansmission	<value>		0	65535	0
:PTRansmission?	<value>				
:PRESet					

† No unit is specified, but all values are in degrees.

The Common Commands

The IEEE 488.2 standard has a list of reserved commands, called common commands. These are the commands that start with an asterisk. Some of these commands must be implemented by any instrument using the standard, others are optional. This section describes the implemented commands

Common Status Information

There are four registers for the common status information. Two of these are status-registers and two are enable-registers. These registers conform to the *IEEE Standard 488.2-1987*. You can find further descriptions of these registers under `*ESE`, `*ESR?`, `*SRE`, and `*STB?`.

The following figure shows how the registers are organized.

Status Register

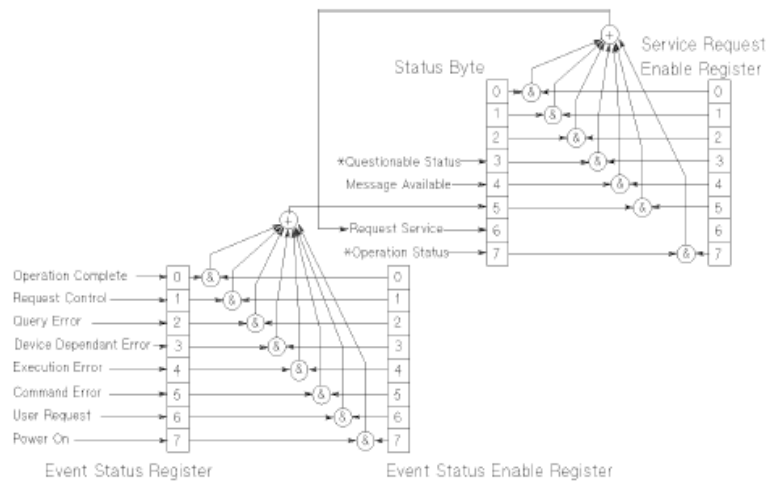

Figure 13 Common Status Registers

*The questionable and operation status trees are described in `\STATUS Commands`.

NOTE

Unused bits in any of the registers return 0 when you read them.

SRQ, The Service Request

A service request (SRQ) occurs when a bit in the Status Byte register goes from 0 → 1 AND the corresponding bit in the Service Request Enable Mask is set.

The Request Service (RQS) bit is set to 1 at the same time that the SRQ is caused. This bit can only be reset by reading it by a serial poll. The RQS bit is The Request Service (RQS) bit is set to 1 at the same time that the SRQ is caused. This bit can only be reset by reading it by a serial poll. The RQS bit is not affected by the condition that caused the SRQ. The serial poll command transfers the value of the Status Byte register to a variable.

*CLS

Syntax*

Definition

The *CLS command clears the following:

- Standard event status register (ESR)
- Status byte register (STB)
- The Error Queue

After the *CLS command the instrument is left waiting for the next command. The instrument setting is unaltered by the command, though *OPC/*OPC? actions are canceled.

If the *CLS command occurs directly after a program message terminator, the output queue and MAV, bit 4, in the status byte register are cleared, and if condition bits 2-0 of the status byte register are zero, MSS, bit 6 of the status byte register is also zero.

Example

```
OUTPUT 724;"*CLS"
```

ESE*Syntax**

*ESE <wsp><value> 0 _< value _<255

Definition

The *ESE command sets bits in the standard event status enable register (ESE) that enable the corresponding bits in the standard event status register (ESR). The register is cleared:

- At power-on
- By sending a value of zero

The register is not changed by the *RST and *CLS commands.

Table 4 The Event Status Enable Register

BIT	MNEMONIC	BIT VALUE
7	Power On	128
6	User Request	64
5	Command Error	32
4	Execution Error	16
3	Devicedependent Error	8
2	Query Error	4
1	Request Error	2
0	Operation Complete	1

***ESE?**

The standard event status enable query returns the contents of the standard event status enable register.

Example

OUTPUT 724;"*ESE 21"

OUTPUT 724;"*ESE?"

ENTER 724; AS

***ESR?**

Syntax

*ESR?

Definition

The standard event status register query returns the contents of the standard event status register. The register is cleared after being read.

0 _<contents _<255

Table 5 The Standard Event Status Register

BITS	MNEMONICS	BIT VALUE
7	Power On	128
6	User Request	64
4	Execution Error	16
3	Devicedependent Error	8
2	Query Error	4
1	Request Error	2
0	Operation Complete	1

Example

OUTPUT 724: "*ESR?"

ENTER 724; AS

***IDN?**

Syntax

*IDN?

Definition

The identification query commands the instrument to identify itself over the interface.

Response: Agilent Technologies, Agilent 8169A, mmmmmmmmm, n.nn

Agilent Technologies: manufacturer

Agilent 8169A: instrument model number
mmmmmmmmmm: serial number
n.nn: firmware revision level

Example

```
DIM AS [100]
OUTPUT 724;"*IDN?"
ENTER 724;AS
```

OPC*Syntax**

*OPC

Definition

Definition The instrument parses and executes all program message units in the input queue and sets the operation complete bit in the standard event status register (ESR). This command can be used to avoid filling the input queue before the previous commands have finished executing.

Example

```
OUTPUT 724;"*CLS;*ESE 1;*SRE 32"
OUTPUT 724;"*OPC"
```

***OPC?**

This query causes all the program messages in the input queue to be parsed and executed. Once it has completed it places an ASCII '1' in the output queue. There is a short delay between interpreting the command and putting the '1' in the queue.

Example

```
OUTPUT 724;"*CLS;*ESE 1;*SRE 32"
OUTPUT 724;"*OPC?"
ENTER 724;AS
```

RCL*Syntax**

*RCL <wsp> <location>

0 _<location _<9

Definition

An instrument setting from the internal RAM is made the actual instrument setting (this does not include GPIB address or parser).

You recall user settings from locations 1-9. See *SAV". Location 0 contains the default setting, which is the same as that obtained by *RST.

Example

OUTPUT 724;"*RCL 3"

RST*Syntax**

*RST

Definition

The reset setting (default setting) stored in ROM is made the actual setting.

Instrument state: the instrument is placed in the idle state awaiting a command.

The following are not changed:

- GPIB (interface) state
- Instrument interface address
- Output queue
- Service request enable register (SRE)
- Standard event status enable register (ESE)

The commands and parameters of the reset state are listed in the following table.

Table 6 Reset State (Default Setting)

Parameter	Reset Value
Pol	0.00°
$\lambda/4$	0.00°
$\lambda/2$	0.00°
Speed	Fast

Example

Example OUTPUT 724;""RST"

SAV*Syntax**

*SAV <wsp> <location>

1 _<location _<9

Definition

Definition The instrument setting is stored in RAM. You can store settings in locations 1-9. The scope of the saved setting is identical with the scope of the standard setting described in *RST".

Example

OUTPUT 724;""SAV 3"

SRE*Syntax**

*SRE <wsp> <value>

Definition

The service request enable command sets bits in the service request enable register that enable the corresponding status byte register bits.

The register is cleared:

- At power-on
- By sending a value of zero.

The register is not changed by the *RST and *CLS commands.

Table 7 The Service Request Enable Register

BITS	MNEMONICS	BIT VALUE
7	Operation Status	128
6	Request Status	64
5	Event Status Byte	32
4	Message Available	16
3	Questionable Status	8
2	Not used	0
1	Not used	0
0	Not used	0

NOTE

Bit 6 cannot be masked.

***SRE?**

The service request enable query returns the contents of the service request enable register.

Example

```
OUTPUT 724;"*SRE 48"
```

```
OUTPUT 724;"*SRE?"
```

```
ENTER 724; AS
```

STB?*Syntax**

```
*STB?
```

Definition

The read status byte query returns the contents of the status byte register.

```
0 _ contents _ 255
```

Table 8 The Status Byte Register

BITS	MNEMONICS	BIT VALUE
7	Operation Status	128
6	Request Status	64
5	Event Status Byte	32
4	Message Available	16
3	Questionable Status	8
2	Not used	0
1	Not used	0
0	Not used	0

Example

Example OUTPUT 724; "**STB?"

ENTER 724; AS

***TST?**
Syntax

*TST?

Definition

Definition The self-test query commands the instrument to perform a self-test and place the results of the test in the output queue. Returned value: 0 _<value _<65535. This value is the sum of the results for the individual tests

Table 9 The Self Test Results

BITS	MNEMONICS	BIT VALUE
14	Motor 3	16384
13	Motor 2	8192
12	Motor 1	4096
10	Counter 3	1024
9	Counter 2	512
8	Counter 1	256
5	DSP Timeout	32
4	DSP Communications	16
3	Calibration Data	8
1	Battery RAM	2
0	Calibration Data Checksum	1

So 16 would mean that the DSP (Digital Signal Processor) Communications had failed, 18 would mean that the DSP Communications had failed, and so had the Battery RAM. A value of zero shows no errors.

No further commands are allowed while the test is running.

The instrument is returned to the setting that was active at the time the self-test query was processed.

The self-test does not require operator interaction beyond sending the *TST? query.

Example

```
OUTPUT 724; "*TST?"
```

```
ENTER 724; AS
```

***WAI**

Syntax

*WAI

Definition

The wait-to-continue command prevents the instrument from executing any further commands, all pending operations are completed.

Example

OUTPUT 724; "*WAI"

Switching On and Off the Instrument Display

These are the commands for enabling or disabling the display on the instrument.

:DISPlay:ENABle

Syntax

:DISPlay:ENABle <wsp> OFF|ON|0|1

Description

This command enables or disables the front panel display. Set the state to OFF or 0 to switch the display off, set the state to ON or 1 to switch the display on. The default is for the display to be on.

:DISPlay:ENABle?

Syntax

:DISPlay:ENABle?

Description

The query returns the current state of the display.

A returned value of 0 shows that the display is off. A returned value of 1 shows that the display is on.

Example

```
OUTPUT 724;":DISP:ENAB ON"
```

```
OUTPUT 724;":DISP:ENAB?"
```

```
ENTER 724;AS
```

Positioning the Polarizing Filter

These are the commands that deal with the position of the polarizing filter.

[[:INPut]:POSition:POLarizer

Syntax

[[:INPut]:POSition:POLarizer <wsp>
<value> | MINimum | MAXimum | DEFault where value is a floating point number between -360.00 and 360.00.

Description

This command sets the position of the polarizing filter. The parameter may be either

- a number, in mechanical degrees (do not give a unit; the number will be rounded to the nearest 0.05°),
- MINimum (-360.00°),
- MAXimum (360.00°), or
- DEFault (0.00°).

[[:INPut]:POSition:POLarizer?

Syntax

[[:INPut]:POSition:POLarizer?

Description

This query gets the position of the polarizing filter in mechanical degrees (without a unit).

Example

OUTPUT 724;"POS:POL 127"

OUTPUT 724;"POS:POL?"

ENTER 724;AS

Setting the State of Polarization

These are the commands that deal with positioning the $\lambda/4$ and $\lambda/2$ retarder plates, and setting the state of polarization by specifying the coordinates on the Poincare sphere.

[[:INPut]:CIRClE:EPSilonb

Syntax

`[[:INPut]:CIRClE:EPSilonb <wsp> <value> | MINimum | MAXimum | DEFault`
where value is a floating point number between -720.00 and 720.00.

Description

This command sets the $2 \varepsilon_B$ position on the Poincare sphere. The parameter may be either

- a number, in optical degrees (do not give a unit; the number will be rounded to the nearest 0.05°),
- MINimum (-720.00°),
- MAXimum (720.00°), or
- DEFault (0.00°).

NOTE

The value you specify with this command is for $2 \varepsilon_B$.

[[:INPut]:CIRClE:EPSilonb?

Syntax

`[[:INPut]:CIRClE:EPSilonb?`

Description

This query gets the $2 \varepsilon_B$ position on the Poincare sphere in optical degrees (without a unit).

NOTE

The value you specify with this command is for $2 \epsilon_B$.

[[:INPut]:CIRClE:THETap**Syntax**

[[:INPut]:CIRClE:THETap <wsp> <value> | MINimum | MAXimum | DEFault
where value is a floating point number between -2160.00 and 2160.00.

Description

This command sets the position of the $2 \theta_p$ position on the Poincare sphere. The parameter may be either

- a number, in optical degrees (do not give a unit; the number will be rounded to the nearest 0.05°),
- MINimum (-2160.00°),
- MAXimum (2160.00°), or
- DEFault (0.00°).

NOTE

The value you specify with this command is for $2 \theta_p$.

[[:INPut]:CIRClE:THETap?**Syntax**

[[:INPut]:CIRClE:THETap?

Description

This query gets the position of the $2 \theta_p$ position on the Poincare sphere in optical degrees (without a unit).

NOTE

The value returned by this query is for $2 \theta_p$.

Example

```
OUTPUT 724;":CIRC:EPS 128"
```

```
OUTPUT 724;":CIRC:THET 270"
```

```
OUTPUT 724;":CIRC:EPS?"
```

```
ENTER 724;E$
```

```
OUTPUT 724;":CIRC:THET?"
```

```
ENTER 724;T$
```

[:INPut]:POSiTion:HALF**Syntax**

[:INPut]:POSiTion:HALF <wsp> <value> | MINimum | MAXimum | DEFault
where value is a floating point number between -360.00 and 360.00.

Description

This command sets the position of the $\lambda/2$ retarder plate. The parameter may be either

- a number, in mechanical degrees (do not give a unit; the number will be rounded to the nearest 0.05°),
- MINimum (-360.00°),
- MAXimum (360.00°), or
- DEFault (0.00°).

[:INPut]:POSiTion:HALF?**Syntax**

```
[:INPut]:POSiTion:HALF?
```

Description

This query gets the position of the $\lambda/2$ retarder plate in mechanical degrees (without a unit).

[[:INPut]:POSition:QUARter**Syntax**

[[:INPut]:POSition:QUARter <wsp>

<value> | MINimum | MAXimum | DEFault where value is a floating point number between -360.00 and 360.00.

Description

This command sets the position of the $\lambda/4$ retarder plate. The parameter may be either

- a number, in mechanical degrees (do not give a unit; the number will be rounded to the nearest 0.05°),
- MINimum (-360.00°),
- MAXimum (360.00°), or
- DEFault (0.00°).

[[:INPut]:POSition:QUARter?**Syntax**

[[:INPut]:POSition:QUARter?

Description

This query gets the position of the $\lambda/4$ retarder plate in mechanical degrees (without a unit).

Example

OUTPUT 724;":POS:QUAR 64"

OUTPUT 724;":POS:HALF 99.5"

OUTPUT 724;":POS:QUAR?"

ENTER 724:QS

OUTPUT 724;":POS:HALF?"

ENTER 724:HS

Scanning the Poincare Sphere

These are the commands for varying the state of polarization automatically over time.

[:INPut]:PSPHere:RATE

Syntax

```
[:INPut]:PSPHere:RATE <wsp> 0 | 1
```

Description

This command sets the speed at which the the state of polarization is changed.

- 0 set the speed to slow (for polarization dependent measurements), or
- 1 sets the speed to fast (for quasi-depolarized signals).

[:INPut]:PSPHere:RATE?

Syntax

```
[:INPut]:PSPHere:RATE?
```

Description

This query gets the the speed at which the the state of polarization is set to change.

- 0 if the speed is set to slow
- 1 if the speed is set to fast, or

:INITiate[:IMMediate]

Syntax

```
:INITiate[:IMMediate]
```

Description

This command starts the application.

ABORt**Syntax**

:ABORt

Description

This command aborts an application that is running.

Example

OUTPUT 724;":PSPH:RATE 1"

OUTPUT 724;":INIT" ...

OUTPUT 724;":PSPH:RATE?"

ENTER 724;RS ..

OUTPUT 724;":ABOR"

STATus Commands

There are two 'nodes' in the status circuitry. The OPERATION node shows things that can happen during normal operation. The QUESTIONABLE node shows error conditions.

Each node of the status circuitry has five registers:

- A condition register (CONDition), which contains the current status. This register is updated continuously. It is not changed by having its contents read.
- The event register (EVENT), which contains the output from the transition registers. The contents of this register are cleared when it is read.
- A positive transition register (PTRansition), which, when enabled, puts a 1 into the event register, when the corresponding bit in the condition register goes from 0 to 1.

The power-on condition for this register is for all the bits to be enabled.

- A negative transition register (NTRansition), which, when enabled, puts a 1 into the event register, when the corresponding bit in the condition register goes from 1 to 0.

The power-on condition for this register is for all the bits to be disabled.

- The enable register (ENABle), which enables changes in the event register to affect the Status Byte.

The status registers for the polarization controller are organized as shown:

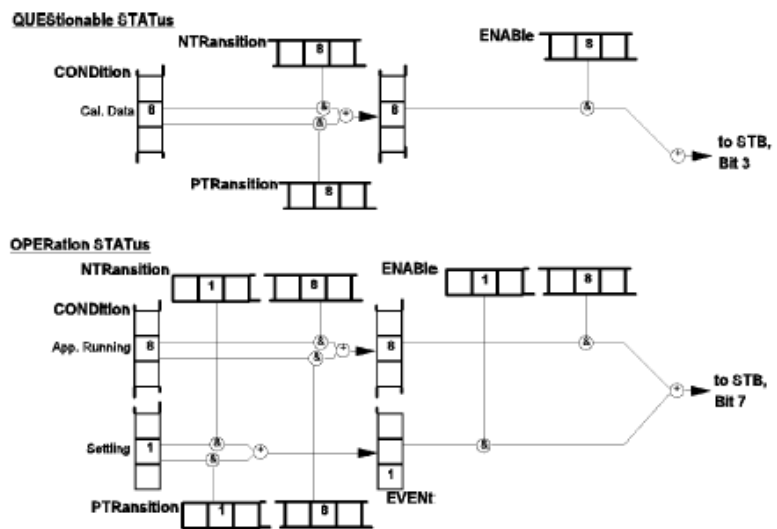

Figure 14 The Status Registers

Setting Up the STATUS Registers

These are the commands for setting up the registers.

:STATUS:PRESet

Syntax

:STATUS:PRESet

Description

This command presets all the enable registers and transition filters for both the OPERation and QUEStionable nodes.

- All the bits in the ENABle registers are set to 0
- All the bits in the PTRansition registers are set to 1
- All the bits in the NTRansition registers are set to 0

Example

OUTPUT 724;":STAT:PRES"

Only two bits of the OPERation node are used:

- Bit 1 to show that the instrument is settling (that is that the polarizer and the $\lambda/4$ and $\lambda/2$ plates have not reached position.
- Bit 8 shows that an application is running.

:STATUS:OPERation:NTRansition

Syntax

:STATUS:OPERation:NTRansition <wsp> <value>

Description

This command sets the bits in the NTRansition register. Setting a bit in this register enables a negative transition (1/0) in the corresponding bit in the CONDition register to set the bit in the EVENT register.

:STATus:OPERation:NTRansition?.**Syntax**

:STATus:OPERation:NTRansition?

Description

This query returns the current contents of the OPERation:NTRansition register.

:STATus:OPERation:PTRansition**Syntax**

:STATus:OPERation:PTRansition <wsp> <value>

Description

This command sets the bits in the PTRansition register. Setting a bit in this register enables a positive transition (0/1) in the corresponding bit in the CONDition register to set the bit in the EVENT register.

:STATus:OPERation:PTRansition?.**Syntax**

:STATus:OPERation:PTRansition?

Description

This query returns the current contents of the OPERation:PTRansition register.

:STATus:OPERation:ENABLE**Syntax**

:STATus:OPERation:ENABLE <wsp> <value>

Description

This command sets the bits in the ENABLE register that enable the contents of the EVENT register to affect the Status Byte (STB). Setting a bit in this register to 1 enables the corresponding bit in the EVENT register to affect bit 7 of the Status Byte.

:STATus:OPERation:ENABle?.**Syntax**

```
:STATus:OPERation:ENABle?
```

Description

The query returns the current contents of the OPERation:ENABle register.

Example

```
OUTPUT 724;"STAT:OPER:NTR 2"
```

```
OUTPUT 724;"STAT:OPER:PTR 256"
```

```
OUTPUT 724;"STAT:OPER:ENAB 258"
```

```
OUTPUT 724;"STAT:OPER:NTR?"
```

```
ENTER 724;N$
```

```
OUTPUT 724;"STAT:OPER:PTR?"
```

```
ENTER;P$
```

```
OUTPUT 724;"STAT:OPER:ENAB?"
```

```
ENTER 724;E$
```

Only one bit of the QUEStionable node is used:

- Bit 8 shows that there is an error in the calibration data.

:STATus:QUEStionable:NTRansition**Syntax**

```
:STATus:QUEStionable:NTRansition <wsp> <value>
```

Description

This command sets the bits in the NTRansition register. Setting a bit in this register enables a negative transition (1/0) in the corresponding bit in the CONDition register to set the bit in the EVENT register.

:STATus:QUEStionable:NTRansition?.**Syntax**

:STATus:QUEStionable:NTRansition?

Description

This query returns the current contents of the QUEStionable:NTRansition register.

:STATus:QUEStionable:PTRansition**Syntax**

:STATus:QUEStionable:PTRansition <wsp> <value>

Description

This command sets the bits in the PTRansition register. Setting a bit in this register enables a positive transition (0/1) in the corresponding bit in the CONDition register to set the bit in the EVENT register.

:STATus:QUEStionable:PTRansition?.**Syntax**

:STATus:QUEStionable:PTRansition?

Description

This query returns the current contents of the QUEStionable:PTRansition register.

:STATus:QUEStionable:ENABLE**Syntax**

:STATus:QUEStionable:ENABLE <wsp> <value>

Description

This command sets the bits in the ENABLE register that enable the contents of the EVENT register to affect the Status Byte (STB). Setting a bit in this register to 1 enables the corresponding bit in the EVENT register to affect bit 3 of the Status Byte.

:STATus:QUEStionable:ENABLE?**Syntax**

:STATus:QUEStionable:ENABLE?

Description

This query returns the current contents of the QUEStionable:ENABLE register

Example

```
OUTPUT 724;":STAT:QUES:NTR 256"
```

```
OUTPUT 724;":STAT:QUES:PTR 256"
```

```
OUTPUT 724;":STAT:QUES:ENAB 256"
```

```
OUTPUT 724;":STAT:QUES:NTR?"
```

```
ENTER 724;N$"
```

```
OUTPUT 724;":STAT:QUES:PTR?"
```

```
ENTER 724;P$"
```

```
OUTPUT 724;":STAT:QUES:ENAB?"
```

```
ENTER 724;E$"
```

Checking the Status

These commands are for checking the status of the instrument, as reported in the OPERational and QUEStionable STATus registers.

NOTE

See also [The Common Commands](#) for the standard IEEE 488.2 status registers.

:STATus:OPERation:CONDition?

Syntax

:STATus:OPERation:CONDition?

Description

This query reads the contents of the OPERation:CONDition register. Only two bits of the condition register are used:

Table 10

BITS	MNEMONICS	BIT VALUE
8	Setting	256
1	Application	2

Example

OUTPUT 724;":STAT:OPER:COND?"

ENTER 724;AS

:STATus:OPERation[:EVENT]?

Syntax

:STATus:OPERation[:EVENT]?

Description

This query reads the contents of the OPERation:EVENT register. Only two bits of the event register are used (whether these bits contain information depends on the transition register configuration):

Table 11

BITS	MNEMONICS	BIT VALUE
8	Setting	256
1	Application	2

Example

```
OUTPUT 724;":STAT:OPER?"
ENTER 724;AS
```

:STATus:QUEStionable:CONDition?**Syntax**

```
:STATus:QUEStionable:CONDition?
```

Description

This query reads the contents of the QUEStionable:CONDition register. Only one bit of the condition register is used:

Table 12

BITS	MNEMONICS	BIT VALUE
8	Calibration Data	256

Example

```
OUTPUT 724;":STAT:QUES:COND?"
ENTER 724;AS
```

:STATus:QUEStionable[:EVENT]?**Syntax**`:STATus:QUEStionable[:EVENT]?`**Description**

This query reads the contents of the QUEStionable:EVENT register. Only one bit of the event register is used (whether these bits contain information depends on the transition register configuration):

Table 13

BITS	MNEMONICS	BIT VALUE
8	Calibration Data	256

Example`OUTPUT 724;":STAT:QUES?"``ENTER 724;AS`

SYSTem Commands

:SYSTem:ERRor?

Syntax

:SYSTem:ERRor?

Description

Description This query returns the next error from the error queue (see "The Error Queue" in Chapter 5). Each error has the error code and a short description of the error, separated by a comma, for example 0, "No error". Error codes are numbers in the range -32768 and +32767. Negative error numbers are defined by the SCPI standard. Positive error numbers are device dependent. The errors are listed in Appendix F

Example

```
OUTPUT 724;":SYST:ERR?"
```

```
ENTER 724;AS
```

:SYSTem:VERSion?

Syntax

:SYSTem:VERSion?

Description

This query returns the version of the SCPI command set being used in the format yyyy.v, where yyyy is the year, and v is the version. For this instrument, the value returned is always 1994.0

Example

```
OUTPUT 724;":SYST:VERS?"
```

```
ENTER 724;AS
```

7

Programming Examples

This chapter gives some programming examples. The language used for the programming is BASIC 5.1 Language System used on HP 9000 Series 200/300 computers.

These programming examples do not cover the full command set for the instrument. They are intended only as an introduction to the method of programming the instrument. The programming examples use the GPIB.

Example 1 - Checking Communication	86
Example 2 - Status Registers and Queues	87
Example 3 - Finding the Optimum Transmission SoP	90
Example 4 - Finding the Polarization Dependence	94

Example 1 - Checking Communication

Function

This program sends a query, and displays the reply.

Listing

Table 14

10	!-----
20	!
30	!Keysight 8169A Programming Example 1
40	!
50	!A Simple Communication Check
60	!
70	!-----
80	!
90	!Definitions and initialization
100	!
110	Pol=724
<i>This statement sets the address of the polarisation controller. The first 7 is to access the GPIB card in the controller; the 24 is it's GPIB address</i>	
120	DIM String\$ [50]
130	!
150	PRINT TABXY (5, 10); "Programming Example 1, Simple Communications"
160	!
170	! Send an IDN and get the Identification
180	!
190	OUTPUT Pol; "*IDN?"
200	ENTER Pol::String\$
210	PRINT TABXY (10, 12); "Identification : ";String\$
220	!
230	END

Example 2 - Status Registers and Queues

Function

This program sends a commands and queries typed in by the user. The contents of the status byte and the standard event status register are displayed. These registers are updated for each new command, and each time a Service ReQuest (SRQ) occurs. The number of the most recent error, and the most recent contents of the output queue is also displayed.

Listing

Table 15

```

10      !-----
20      !
30      ! Keysight 8169A Programming Example 2
40      !
50      ! Status Structure and a useful self lesrning tool
60      !
70      !-----
80      !
90      ! Declarations and initialization
100     !
110     INTEGER Value,Bit,Quot,Xpos,Ypos
120     DIM Inp$ [100]
130     DIM A$ [300]
140     Pol=724
150     ON INTR 7 GOSUB Pmm_srq
160     !
170     ! Mask the registrers
180     !
190     OUTPUT Pol; "=SRE 248

The *SRE 248 command enables bits 7 (Operation Status Summary), 5 (ESB), 4 (MAV),
and 3 (Questionable Status Summary) in the status byte (bit 6 (SRQ) cannot be disabled in
this register).
The *ESE 255 command enables all of the bits in the Event Status Register.

200     !
210     ! Set up the screen
220     !
230     CLEAR SCREEN
240     PRINT TABXY (40, 3); "Status Byte"
250     PRINT TABXY (4, 1); " OPS SRQ ESB MAV QUE "
260     PRINT TABXY (4, 2); " +-----+ "
270     PRINT TABXY (4, 3); " : "
280     PRINT TABXY (4, 4); " +-----+ "
290     PRINT TABXY (4, 5); " ^ "
300     PRINZT TABXY (4, 6); " : "
310     PRINZT TABXY (4, 7); " +-----+ "
320     PRINZT TABXY (4, 8); " : OR : "

```

Programming Examples

```
330 PRINZT TABXY (4, 9) ; " +-----+
340 PRINZT TABXY (4, 10) ; " ^^^^"
350 PRINZT TABXY (4, 11) ; " +-----+
360 PRINZT TABXY (4, 12) ; " :::::"
370 PRINZT TABXY (4, 13) ; " +-----+
380 PRINZT TABXY (4, 14) ; " PON URQ CME EXE DDE QYE RQC POPC "
390 PRINZT TABXY (4, 15) ; " Standard Event Status Register "
400 PRINZT TABXY (4, 16) ; " Last Command "
410 PRINZT TABXY (4, 17) ; " Last Error "
420 PRINZT TABXY (4, 18) ; " Output Queue "
430 !
440 ! Start the program loop and enable the interrupt for the errors
450 !
460 Ende=0
470 GOSUB Pmm_srq
480 ENABLE INTR 7;2
490 !
500 ! The Central Loop
510 !
520 REPEAT
530     INPUT "Command ? ",Inp$
540     GOSUB Pmm_spq
550     OUTPUT Pol ; Inp$
560     PRINT TABXY (21,16) ;"
570     PRINT TABXY (21,16) ; Inp$
580     WAIT 1.0
590 UNTIL Ende=1
600 GOTO 1380
610 !
620 !-----
630 Pmm_srq: ! Interrupt Handling Subroutine to display the status, and the error
640 ! and output queues
650 !-----
660 !
670 ! Get the value for the Status Byte
680 !
690 Value=SPOLL (Pol)
700 !
710 ! Initialize and start the display of the registers
720 !
730 PRINT TABXY (21,17) ;"
740 PRINT TABXY (21,18) ;"
750 Ypos=3
760 FOR Z=0 TO 1
770     Bit=128
780     Xpos=7
790     !
800     ! Do it for each bit
810     !
820     REPEAT
830         Quot=Value DIV Bit
```



```

840      !
850      ! If the bit is set then display 1
860      !
870      IF Quot>0 THEN
880          PRINT TABXY(Xpos,Ypos);"1"
890          Value=Value-Bit
900      !
910      ! If MAV is set, then get and display the output queue contents
920      !
930      IF Z=0 THEN
940          IF Bit=16 THEN
950              ENTER Pol;A$
960              PRINT TABXY(21,18);A$
970          END IF
980      END IF
990      !
1000     ! If the bit is not set, then display 0
1010     !
1020     ELSE
1030         PRINT TABXY(Xpos,Ypos);"0"
1040     END IF
1050     !
1060     ! Set up for the next iteration
1070     !
1080     Bit=Bit DIV 2
1090     Xpos=Xpos+4
1100 UNTIL Bit=0
1110     !
1120     ! Now that the status byte is displayed, get the Standard Events
1130     ! Status Register
1140     !
1150     OUTPUT Pol;"**ESR?"
1160     ENTER Pol;Value
1170     !
1180     ! Set up to display the ESR
1190     !
1200     Ypos=12
1210     NEXT Z
1220     !
1230     ! Read and display any messages in the error queue
1240     !
1250     REPEAT
1260     OUTPUT Pol;"SYSTEM:ERROR?"
1270     ENTER Pol;Value,A$
1280     ! The SYSTEM:ERROR? query gets the number of the last error in the error queue.
1290     UNTIL Value=0
1300     !
1310     ! Clear the Status structure and reenale the interrupt before returning
1320     !
1330     OUTPUT Pol;"**CLS"
1340     ENABLE INTR 7
1350     !
1360     RETURN
1370     !
1380     END

```

Example 3 - Finding the Optimum Transmission SoP

Function

This program performs the same sequence as the example given in chapter 2. That is, to find the state of polarization for optimum transmission for a linear device under test (DUT).

Requirements

For this example, you will need, apart from the polarization controller, a laser source, and a power meter (in the description below, a Keysight 8163B Lightwave Multimeter with a laser module and a sensor module are used). We will use the length of fiber connecting the instruments as our linear DUT.

Setting Up the Equipment

- 1 With both instruments switched off, connect the laser source to the polarization controller.
- 2 Connect the polarization controller to the power meter.

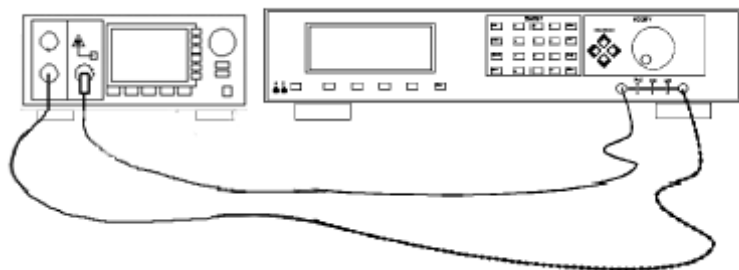

Figure 15 Setup for setting the position of the polarizing filter.

- 3 Switch on both instruments, and enable the laser source.
- 4 Set the channel with the sensor module to the wavelength of the source, and select the default averaging speed (200 ms).

Listing

Table 16

```

10      !-----
20      !
30      ! Programming Example 3
40      !
50      ! Finding the Optimum Transmission Polarization
60      !
70      !-----
80      !
90      ! Definitions and Initializations
100     !
110     Pol=724
120     Mm=722
130     !
140     OUTPUT Mm;"*rst;*cls"
150     OUTPUT Pol;"*rst;*cls"
160     !
170     ! Setup the instruments, with the output of the source connected
180     ! to the input of the sensor and wait for the ENTER key to be
190     ! pressed before continuing
200     !
210     CLEAR SCREEN
220     True=1
230     False=0
240     !
250     ! Set the Wavelength and the averaging time for the sensor
260     !
270     OUTPUT Mm;"sour:pow:wave?"
280     ENTER Mm;Wl
290     OUTPUT Mm;"sens2:pow:wave ";Wl
300     OUTPUT Mm;"sens2:pow:atime 200ms"
310     !
320     ! Switch on the source
330     !
340     OUTPUT Mm;"sour:pow:state on"
350     !
360     ! Find the position of the polarizing filter, that allows the maximum
370     ! power through
380     !
390     Angle=0
400     Inc=10
410     Maxward=False
420     OUTPUT Mm;"read2:power?"
430     ENTER Mm;Maxpow
440     REPEAT
450         Angle=Angle+Inc
460         OUTPUT Pol;"pos:pol ";Angle
470         OUTPUT Mm;"read2:power?"
480         ENTER Mm;Newpow
490         IF Newpow<Maxpow THEN
500             IF Maxward=True THEN

```

Programming Examples

```
510         Inc=-Inc/2
520     ELSE
530         Inc=-Inc
540         Maxward=True
550     END IF
560 ELSE
570     Maxpow=Newpow
580     Maxward=True
590 END IF
600 UNTIL ABS(Inc)<.05
610 !
620 ! Now search for the worst-case polarization when changing thetap
630 !
640 Angle=0
650 Inc=10
660 Minward=False
670 Minpow=Maxpow
680 REPEAT
690     Angle=Angle+Inc
700     OUTPUT Pol;"circle:thetap ";Angle
710     OUTPUT Mm;"read2:power?"
720     ENTER Mm;Newpow
730     IF Newpow>Minpow THEN
740         IF Minward=True THEN
750             Inc=-Inc/2
760         ELSE
770             Inc=-Inc
780             Minward=True
790         END IF
800     ELSE
810         Minpow=Newpow
820         Minward=True
830     END IF
840 UNTIL ABS(Inc)<.05
850 !
860 ! Now search for the overall worst-case polarization by changing epsilonb
870 !
880 Angle=0
890 Minward=False
900 REPEAT
910     Angle=Angle+Inc
920     OUTPUT Pol;"circle:epsilonb ";Angle
930     OUTPUT Mm;"read2:power?"
940     ENTER Mm;Newpow
950     IF Newpow>Minpow THEN
960         IF Minward=True THEN
970             Inc=-Inc/2
980         ELSE
990             Inc=-Inc
1000             Minward=True
1010         END IF
1020     ELSE
1030         Minpow=Newpow
1040         Minward=True
1050     END IF
1060 UNTIL ABS(Inc)<.05
1070
```

Programming Examples

```
1080      !
1090      ! Now set the optimum by moving to the opposite side of the
1100      ! sphere
1110      !
1120      OUTPUT Pol;"circle:epsilonb ";Angle+180
1130      !
1140      ! And finish . . .
1150      !
1160      OUTPUT Mm;"sour.pow.state off"
1170      END
```

Example 4 - Finding the Polarization Dependence

Function

This program does the same thing as the example session given in chapter 3. That is, to measure the sensitivity to polarization, by applying a quasi-random polarization to the (DUT).

Requirements

For this example, you will need, apart from the polarization controller, a laser source, and a power meter (in the description below, a Keysight 8163B Lightwave Multimeter with a laser module and a sensor module are used). A roll of fiber will act as a suitable DUT.

Setting Up the Equipment

- 1 With both instruments switched off, connect the laser source to the polarization controller.
- 2 Connect the polarization controller to the power meter.

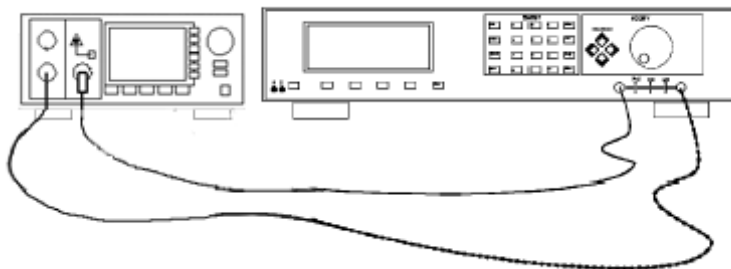

Figure 16 Setup for setting the position of the polarizing filter.

- 3 Switch on both instruments, and enable the laser source.

NOTE

Under normal circumstances you should leave the instruments to warmup. (The multimeter needs around 20 minutes to warmup.) Warming up is necessary for accuracy of the sensor, and the output power of the source.

- 4 Set the channel with the sensor module to the wavelength of the source, and select the default averaging speed (200ms) [Press **Param** to select T, hold **Param** to reset T].

When prompted by the program, you should connect the DUT into the setup, disturbing the setup as little as possible.

Listing

Table 17

```

10      !-----
20      !
30      ! Programming Example 4
40      !
50      ! Finding the Polarization Dependence
60      !
70      !-----
80      !
90      ! Definitions and Initializations
100     !
110     Pol=724
120     Mm=722
130     !
140     OUTPUT Mm;"*rst;*cls"
150     OUTPUT Pol;"*rst;*cls"
160     !
170     ! Setup the instruments, with the output of the source connected
180     ! to the input of the sensor and wait for the ENTER key to be
190     ! pressed before continuing
200     !
210     CLEAR SCREEN
220     True=1
230     False=0
240     !
250     ! Set the Wavelength and the averaging time for the sensor
260     !
270     OUTPUT Mm;"sour:pow:wave?"
280     ENTER Mm;Wl
290     OUTPUT Mm;"sens2:pow:wave ";Wl
300     OUTPUT Mm;"sens2:pow:atime 200ms"
310     !
320     ! Switch on the source
330     !
340     OUTPUT Mm;"sour:pow:state on"
350     !
360     ! Find the position of the polarizing filter, that allows the maximum
370     ! power through
380     !
390     Angle=0
400     Inc=10
410     Maxward=False
420     OUTPUT Mm;"read2:power?"
430     ENTER Mm;Maxpow
440     REPEAT
450         Angle=Angle+Inc
460         OUTPUT Pol;"pos:pol ";Angle
470         OUTPUT Mm;"read2:power?"
480         ENTER Mm;Newpow
490         IF Newpow<Maxpow THEN
500             IF Maxward=True THEN

```

Programming Examples

```
510         Inc=-Inc/2
520         ELSE
530             Inc=-Inc
540             Maxward=True
550         END IF
560     ELSE
570         Maxpow=Newpow
580         Maxward=True
590     END IF
600 UNTIL ABS(Inc)<.05
610 !
620 ! Time to insert the DUT
630 !
640 PRINT TABXY(10,9);"Hit ENTER when you have inserted the DUT!"
650 INPUT Dummy
660 !
670 ! Set up the instruments for slow scanning of the sphere, and at fast
680 ! measurement time to sample the power
690 !
700 OUTPUT Pol;"psphere:rate 0"
710 OUTPUT Mm;"sens2:pow:atime 20ms"
720 OUTPUT Mm;"sens2:pow:unit dbm"
730 ! Set values that have to change for maximum and minimum
740 Minpow=100
750 Maxpow=-100
760 !
770 ! Start the scanning
780 !
790 OUTPUT Pol;"init"
800 !
810 ! Sample enough values to be sure of catching the maximum and minimum
820 !
830 FOR Reading=1 TO 500
840     OUTPUT Mm;"read2:pow?"
850     ENTER Mm;Power
860     IF Power<Minpow THEN Minpow=Power
870     IF Power>Maxpow THEN Maxpow=Power
890 NEXT Reading
900 !
910 ! Calculate (and display) the difference
920 !
930 PRINT TABXY(10,12);"Polarization Dependence",Maxpow-Minpow;"dB"
940 !
950 ! Tidy up and leave
960 !
970 OUTPUT Pol;"abort"
980 OUTPUT Mm;"sour:pow:state off"
990 END
```

8

Installation

This appendix provides installation instructions for the polarization controller. It also includes information about initial inspection and damage claims, preparation for use, packaging, storage, and shipment.

Safety Considerations	98
Initial Inspection	98
AC Line Power Supply Requirements	99
Line Power Cable	99
Replacing the Fuse	101
Replacing the Battery	102
Operating and Storage Environment	102
Temperature	102
Humidity	103
Altitude	103
Installation Category and Pollution Degree	103
Instrument Positioning and Cooling	103
Switching on the Polarization Controller	104
Optical Output	104
Trigger Input and Output	104
GPIB Interface	105
Connector	105
GPIB Logic Levels	106
Claims and Repackaging	106
Return Shipments to Keysight	107

Safety Considerations

The following general safety precautions must be observed during all phases of operation, service, and repair of this instrument. Failure to comply with these precautions or with specific warnings elsewhere in this manual violates safety standards of design, manufacture, and intended use of the instrument. Keysight Technologies assumes no liability for the customer's failure to comply with these requirements.

General

WARNING

This is a Safety Class 1 instrument (provided with a protective earth terminal) and has been manufactured and tested according to international safety standards.

WARNING

Before operation, review the instrument and manual for safety markings and instructions. You must follow these to ensure safe operation and to maintain the instrument in safe condition.

Initial Inspection

Inspect the shipping container for damage. If there is damage to the container or cushioning, keep them until you have checked the contents of the shipment for completeness and verified the instrument both mechanically and electrically.

The Appendix D gives a procedure for checking the operation of the instrument. If the contents are incomplete, mechanical damage or defect is apparent, or if an instrument does not pass the operator's checks, notify the nearest Keysight office.

WARNING

To avoid hazardous electrical shock, do not perform electrical tests when there are signs of shipping damage to any portion of the outer enclosure (covers, panels, etc.).

AC Line Power Supply Requirements

The Keysight 8169A can operate from any single-phase AC power source that supplies between 100V and 240V $\pm 10\%$, at a frequency in the range from 50 to 60Hz. The maximum power consumption is 45VA with all options installed.

Line Power Cable

According to international safety standards, this instrument has a three-wire power cable. When connected to an appropriate AC power receptacle, this cable earths the instrument cabinet. The type of power cable shipped with each instrument depends on the country of destination. Refer to Figure 17 for the part numbers of the power cables available.

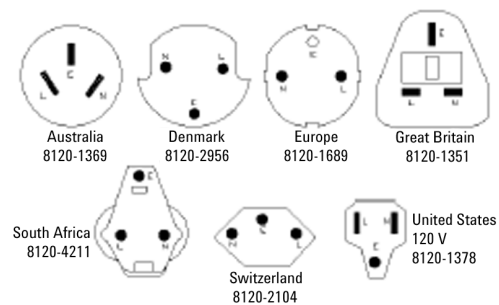

Figure 17 Line Power Cables - Plug Identification

WARNING

To avoid the possibility of injury or death, you must observe the following precautions before switching on the instrument.

WARNING

If this instrument is to be energized via an autotransformer for voltage reduction, ensure that the Common terminal connects to the earth pole of the power source.

WARNING

Insert the power cable plug only into a socket outlet provided with a protective earth contact. Do not negate this protective action by the using an extension cord without a protective conductor.

WARNING

Before switching on the instrument, the protective earth terminal of the instrument must be connected to a protective conductor. You can do this by using the power cord supplied with the instrument.

WARNING

Do not interrupt the protective earth connection intentionally.

The following work should be carried out by a qualified electrician. All local electrical codes must be strictly observed. If the plug on the cable does not fit the power outlet, or if the cable is to be attached to a terminal block, cut the cable at the plug end and rewire it.

The color coding used in the cable depends on the cable supplied. If you are connecting a new plug, it should meet the local safety requirements and include the following features:

- Adequate load-carrying capacity (see table of specifications).
- Ground connection.
- Cable clamp.

WARNING

To avoid the possibility of injury or death, please note that the Keysight 8169A does not have a floating earth.

WARNING

The Keysight 8169A is not designed for outdoor use. To prevent potential fire or shock hazard, do not expose the instrument to rain or other excessive moisture.

The AC power requirements are summarized on the rear panel of the instrument.

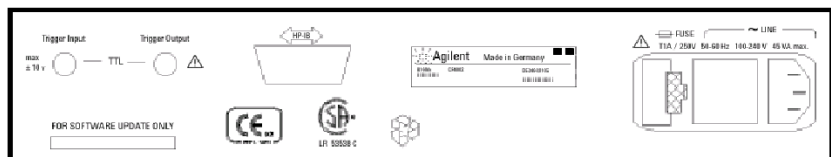

Figure 18 Rear Panel Markings

Replacing the Fuse

There is one fuse in this instrument. This is a T1A/250V (time-lag) (Keysight Part No. 2110-0007). The fuse holder is at the rear of the instrument, beside the line power connector. To replace the fuse,

- 1 Release the fuse holder: use the blade of a flat-headed screwdriver to depress the catch at the side of the holder and then pull the holder out a little.

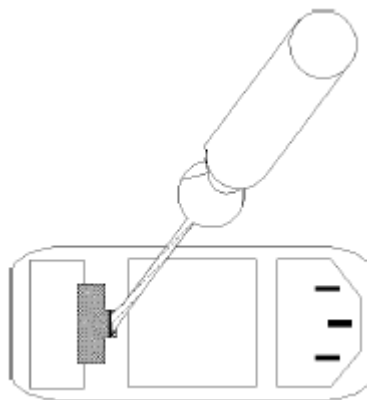

Figure 19 Releasing the Fuse Holder

- 2 Pull the fuse holder out of the instrument.

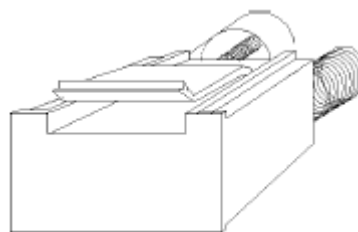

Figure 20 The Fuse Holder

- 3 Check and replace the fuse as necessary making sure that the fuse is always in the top position of the fuse holder, and the bridge is in the bottom.
- 4 Place the fuse holder back in the instrument, and push it until the catch clicks back into place.

Replacing the Battery

This instrument contains a lithium battery. Replacing the battery should be carried out only by a qualified electrician or by Keysight service personnel.

There is a danger of explosion if the battery is incorrectly replaced. Replace only with the same or an equivalent type (Keysight part number 1420-0394). Discard used batteries according to local regulations.

Operating and Storage Environment

The following summarizes the Keysight 8169A operating environment ranges. In order for the polarization controller to meet specifications, the operating environment must be within these limits.

WARNING

The Keysight 8169A is not designed for outdoor use. To prevent potential fire or shock hazard, do not expose the instrument to rain or other excessive moisture.

Temperature

Protect the instrument from temperature extremes and changes in temperature that may cause condensation within it.

The storage and operating temperature for the Keysight 8169A is given in the table below.

Table 18 Temperature

	Operating Range	Storage
Specified	0°C to 55°C	-40°C to 70°C

Humidity

The operating humidity for the Keysight 8169A is 15% to 95% from 0°C to 40°C.

Altitude

The Keysight 8169A may operate at up to 10,000 feet.

Installation Category and Pollution Degree

The Keysight 8169A has Installation Category II and Pollution Degree 2 according to IEC 60664.

Instrument Positioning and Cooling

Mount or position the instrument upright and horizontally so that air can circulate around it freely. When operating the polarization controller, choose a location that provides at least 75mm (3 inches) of clearance at the rear, and at least 25mm (1 inch) of clearance at each side. Failure to provide adequate air clearance may result in excessive internal temperature, reducing instrument reliability.

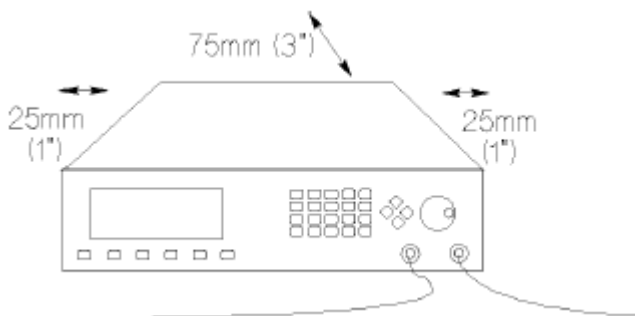

Figure 21 Correct Positioning of the Polarization Controller

Switching on the Polarization Controller

When you switch on the polarization controller it goes through self test. This is the same as the self test described in “*TST?” in Chapter 6.

Optical Output

CAUTION

The polarization controller is supplied with either a straight contact connector (Option 021) or an angled contact connector (Option 022). Make sure that you only use the correct cables with your chosen output. See [Connector Interfaces and Other Accessories](#) in Appendix B for further details on connector interfaces and accessories.

Trigger Input and Output

The Trigger Input should be a standard TTL level signal. That is,

- True = Low = digital ground or 0 Vdc to 0.4 Vdc
- False = High = open or 2.5 Vdc to 5 Vdc

CAUTION

A maximum of ± 10 V can be applied as an external voltage to the Trigger Input BNC connector

The Trigger Output is a standard TTL level signal.

CAUTION

A maximum of between 0 V and +5 V can be applied as an external voltage to the Trigger Output BNC connector.

GPIB Interface

You can connect your GPIB interface into a star network, a linear network, or a combination star and linear network. The limitations imposed on this network are as follows:

- The total cable length cannot exceed 20 meters
- The maximum cable length per device is 2 meters
- No more than 15 devices may be interconnected on one bus.

Connector

The following figure shows the connector and pin assignments. Connector Part Number: 1251-0293

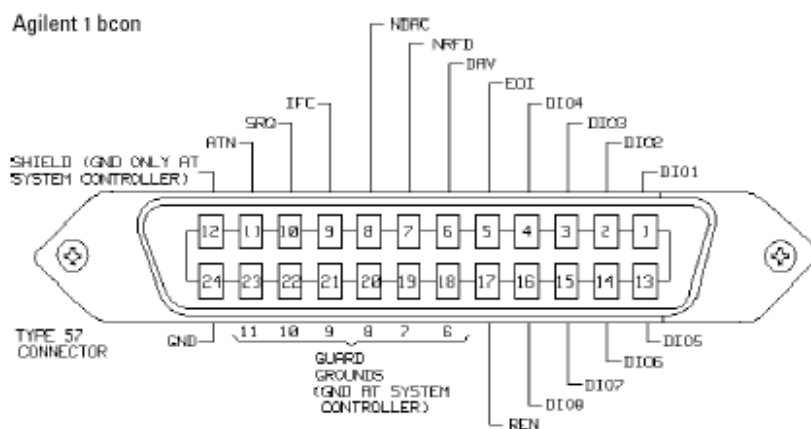

Figure 22 GPIB Connector

CAUTION

Keysight products are equipped with connectors having ISO metric-threaded lock screws and stud mounts (ISO M3.5x0.6) that are black in color. Earlier connectors may have lock screws and stud mounts with imperial-threaded lock screws and stud mounts (6-32 UNC) that have a shiny nickel finish.

CAUTION

It is recommended that you do not stack more than three connectors, one on top of the other.

CAUTION

Hand-tighten the connector lock screws. Do not use a screwdriver.

GPIO Logic Levels

The polarization controller GPIO lines use standard TTL logic, as follows:

- True = Low = digital ground or 0 Vdc to 0.4 Vdc
- False = High = open or 2.5 Vdc to 5 Vdc

All GPIO lines have LOW assertion states. High states are held at 3.0 Vdc by pull-ups within the instrument. When a line functions as an input, it requires approximately 3.2 mA to pull it low through a closure to digital ground. When a line functions as an output, it can sink up to 48 mA in the low state and approximately 0.6 mA in the high state.

NOTE

The GPIO line screens are not isolated from ground.

Claims and Repackaging

If physical damage is evident or if the instrument does not meet specification when received, notify the carrier and the nearest Keysight Service Office. The Sales/Service Office will arrange for repair or replacement of the unit without waiting for settlement of the claim against the carrier.

Return Shipments to Keysight

If the instrument is to be shipped to a Keysight Sales/Service Office, attach a tag showing owner, return address, model number and full serial number and the type of service required.

The original shipping carton and packing material may be reusable, but the Keysight Sales/Service Office will provide information and recommendation on materials to be used if the original packing is no longer available or reusable. General instructions for repacking are as follows:

- 1** Wrap instrument in heavy paper or plastic.
- 2** Use strong shipping container. A double wall carton made of 350-pound test material is adequate.
- 3** Use enough shock absorbing material (3 to 4 inch layer) around all sides of the instrument to provide a firm cushion and prevent movement inside container. Protect control panel with cardboard.
- 4** Seal shipping container securely.
- 5** Mark shipping container FRAGILE to encourage careful handling.
- 6** In any correspondence, refer to instrument by model number and serial number.

Installation

9

Accessories

Instrument and Options	110
GPIB Cables and Adapters	110
Connector Interfaces and Other Accessories	110
Option 021, Straight Contact Connector.....	111
Option 022, Angled Contact Connector	112

Instrument and Options

Table 19 Mainframe

Description	Model No.
Polarization Controller	Keysight 8169A
Pig-tailed fiber ports	Option 020
Straight, contact connectors	Option 021
Angled, contact connectors	Option 022
(Additional Operating and Programming Manual	Option 0B2

GPIB Cables and Adapters

The GPIB connector is compatible with the connectors on the following cables and adapters.

- GPIB Cable, 10833A, 1 m (3.3 ft.)
- GPIB Cable, 10833B, 2 m (6.6 ft.)
- GPIB Cable, 10833C, 4 m (13.2 ft.)
- GPIB Cable, 10833D, 0.5 m (1.6 ft.)
- GPIB Adapter, 10834A, 2.3 cm extender.

Connector Interfaces and Other Accessories

The polarization controller is supplied with one of three connector interface options.

Option 021, Straight Contact Connector

If you want to use straight connectors (such as FC/PC, Diamond HMS-10, DIN, Biconic, SC, ST, or D4) to connect to the instrument, you must

- 1 attach your connector interface (see the list of connector interfaces below) to the interface adapter,
- 2 then connect your cable.

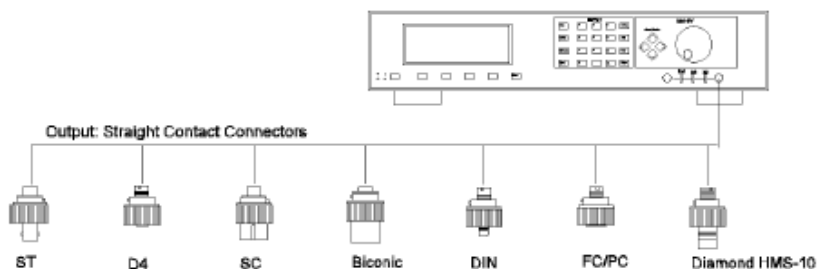

Figure 23 Straight Contact Connector Configuration

Table 20 Connector Interface

Description	Model No.
B	81000WI
D4	81000GI
Diamond HMS-10	81000AI
DIN 47256	81000SI
FC/PC	81000FI
SC	81000KI
ST	81000VI

Option 022, Angled Contact Connector

If you want to use angled contact connectors (such as FC/APC, Diamond HRL-10, DIN, or SC/APC) to connect to the instrument, you must

- 1 attach your connector interface (see the list of connector interfaces below) to the interface adapter,
- 2 then connect your cable.

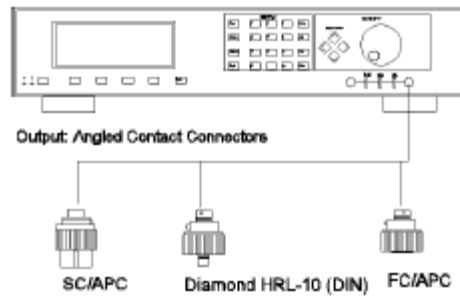

Figure 24 Angled Contact Connector Configuration

Table 21 Connector Interface

Description	Model No.
Diamond HMS-10 (DIN)	81000SI
FC/APC	81000FI or 81000NI
SC/APC	81000KI

10

Specifications

Introduction.....	114
Other Specifications	115
Declaration of Conformity.....	116

Introduction

Specifications describe the instrument's warranted performance over the 0°C to +55°C temperature range after a one hour warm up period. Characteristics provide information about non-warranted performance. Specifications are given in normal type, characteristics are given in italicized type. Spliced fiber pigtail interfaces are assumed for all cases, except where stated otherwise.

Description	8169A
Operating Wavelength Range ^{[1], [5]}	1400 to 1640 nm
Insertion Loss ^{[1], [5]} Variation over 1 full rotation ^{[1], [5]} Variation over complete wavelength range ^{[1], [5]}	< 1.5 dB $\leq \pm 0.03$ dB $\leq \pm 0.1$ dB
Polarization Extinction Ratio ^[2] <i>characteristic</i>	>45 dB (1530 to 1560 nm) >40 dB (1470 to 1570 nm) >30 dB (1400 to 1640 nm)
Polarization Adjustment Resolution ^[3] Fast axis alignment accuracy at home position ^{[3], [4]}	0.18 degree (360 degree/ 2048 encoder position) $\pm 0.2^\circ$
Angular adjustment accuracy minimum step size ^[3] greater than minimum step size ^[3] Setting time (characteristic) Memory Store/Recall registers Angular repeatability after Store/Recall ^{[3], [4]} Number of scan rate settings Maximum rotation rate ^[4]	$\pm 0.09^\circ$ $< \pm 0.5^\circ$ < 200 ms 9 $\pm 0.09^\circ$ 2 3600°/sec
Maximum Operating Input Power Limitation	+ 23 dB
Operating Port Return Loss Individual reflections /Characteristic) ^[5]	>60 dB
Power Requirement	48 to 60 Hz 100/120/220/240 V _{rms} 45 VA _{max}
Weight	9 kg (20 lb)
Dimensions (H x W x D)	10 x 42.6 x 44.5 cm 3.9 x 16.8 x 17.5 in

- [1] Guaranteed over a wavelength range from 1470 to 1570 nm; characteristic for a wavelength range from 1400 to 1640 nm
- [2] Extinction ratio only refers to the polarized portion of the optical signal.
- [3] Guaranteed by design (DAC resolution)
- [4] Angles are mechanical rotation angles of the wave plates.
- [5] Only with Option 020

Other Specifications

Acoustic Noise Emission:	Geräuschemmissionswerte
For ambient temperature up to 30° C L _p - 30 dB(A) L _w - 4.2 BEL Typical operator position 35dBA Normal operation <20dBA (<3.2Bel). Data are results from type tests per ISO 7779 (EN 27779)	Bei einer Umgebungstemperatur bis 30° C L _p - 30 dB(A) L _w - 4.2 BEL am Arbeitsplatz 35dBA normaler Betrieb <20dBA (<3.2Bel). Die Angabe ist das Ergebnis von Typprüfungen gemäß ISO 7779 (EN 27779)

Declaration of Conformity

Click the following link to view or download the latest version of DoC:

<http://www.keysight.com/go/conformity>

11

Performance Test

Introduction.....	118
Insertion Loss Variation with Rotation of $\lambda/4$ and $\lambda/2$ Plates	119
Example	122
Insertion Loss versus Wavelength	123
Example	126
Extinction Ratio of Polarizer.....	127
Example	129

Introduction

Use the Performance Test to verify the instruments warranted performance. Fiber Pigtails (option #020) are assumed for all cases. The tests also can be used as a pure functional tests for connectorized options #021 and #022, as no specifications and uncertainties can be given for these options.

Table 22 Equipment used:

Equipment used	Alternative	#020 pigtail	#021 straight	#022 angled
8168C #023 Tunable Laser Source	81600B #150	1	1	1
8153A Lightwave Multimeter	8163B	1	1	1
81533B Optical Head Interface	81618A	1	1	1
81524A Optical Head	81624B	1	1	1
81000DF Depolarisation Filter		1	1	1
81000BA Bare Fiber Adapter		1	-	-
81000FA FC/PC Connector Adapter		-	1	1
81000SA DIN 47256 Connector Adapter		-	-	1
81000AI Diamond HMS-10 Connector Interface		1	3	1
81000FI FC/PC Connector Interface		2	1	1
81000SI DIN 47256 Connector Interface		-	-	2
81000UM Universal Through Adapter		2	1	1
SEIKO PC/PC adapter		-	1	1
81109AC Diamond HMS-10 / HRL-Diamond HMS-10 / Patchcord		1	1	1
81101BC Diamond HMS-10 Bare Fiber Patchcord		1	-	-
81102BC Diamond HMS-10 / HRL-Bare Fiber Patchcord		1	-	-
81101PC Diamond HMS-10 PC Patchcord		1	2	-
81102SC Diamond HMS-10 /HRL-DIN 47256/4108 Patchcord		-	-	1
81113PC DIN 47256/4108-Super PC Patchcord		-	-	2
TECOS "IFOS-1560CW" Tunable Filter		1	1	1

Insertion Loss Variation with Rotation of $\lambda/4$ and $\lambda/2$ Plates

- 1 Make sure all the connectors you will be using are clean.
- 2 Set up the hardware as shown in [Figure 25](#) .

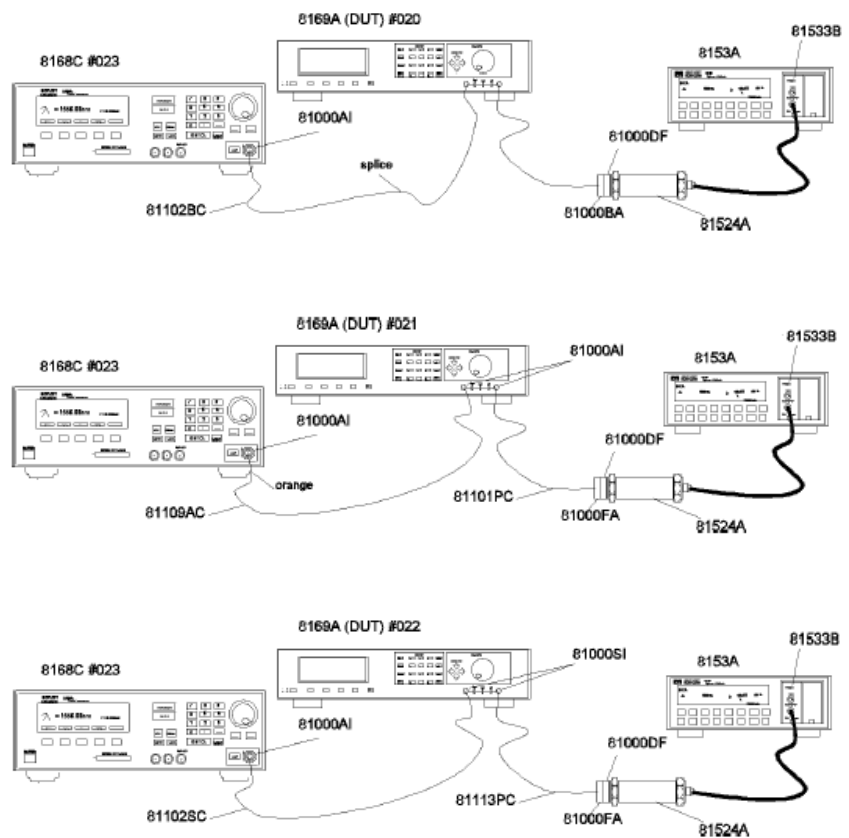

Figure 25 Test Setup for Measuring the Insertion Loss

- For option #020 first splice a Keysight 81102BC patchcord to the pigtail of the Pol-port.
- Make sure that all instruments have warmed up.
- Fix all cables with tape so that they won't move during measurements.

3 Set up the 8153A.

- a Zero the 8153A: press **ZERO**.
- b Set the 8153A to dBm: press **dBm/W** until display shows dBm.
- c Set the 8153A to wavelength = 1470 nm: press **param** until **l** is shown, set **l** to 1470 using the Modify keys.
- d Set the 8153A sample time to 50 ms: press **param** until you get **T**, use the Modify keys, until display reads 50ms.
- e Set 8153A to datalogging:
 - Press **Mode** to get MENU.
 - Press **Record** until you get LOGGING.
 - Press **Edit** to get SAMPLES.
 - Press **Modify** cursor until display reads 500.
 - Press **Next** until you get START.
 - Press **Modify** cursor until you get IMMEDIAT.
 - Press **Edit** to get LOGGING.

4 Set up the 8168C.

- a Press **Wavelength**, press **Edit**, type 1470 on the numeric keypad, press **Enter**.
- b Press **Output Power**, press **Edit**, type 100 on the numeric keypad, press **Enter**.
- c Activate the Optical Output.

5 Set up the 8169A (DUT)

- a Set the polarizing filter for maximum transmission (see "Setting the Position of the Polarizing Filter" in Chapter 2).
- b Press **Sphere**, select Slow with the Modify knob and press **Enter**.
- c Press **Exec**.

6 Execute data logging.

- a On the 8153A press **Exec**.

The 8153A now takes the measurement samples. It will stop automatically when the 500 samples are taken.

7 Get measurement results, MIN/MAX readings:

- a Press **More** to get SHOW.
- b Press **Edit** to get MAXIMUM.
- c Note the displayed value in the test record.
- d Press **Next** to get MINIMUM.
- e Note the displayed value in the test record.
- f Press **Edit** to get SHOW.

8 Press **Record** until you get LOGGING.

9 Repeat list item 6 to list item 7 for wavelengths 1510nm, 1530nm and 1560nm.

To change the wavelength on the 8153A:

- a Press **Edit**, **Mode**, **param** until l appears.
- b Use the Modify keys to set the appropriate l value.

To change the wavelength on the 8168C:

- c Press **Wavelength**, press **Edit**, type the wavelength on the numeric keypad, press **Enter**.

Always note the MAXIMUM and MINIMUM values in your test record.

10 Press **Mode** to get back to MEASURE Mode.

11 Calculate the difference between the "Maximum Power" and the "Minimum Power" as the result for "Insertion Loss Variation with rotation of $\lambda/4$ and $\lambda/2$ plates".

Example

Table 23

Test No.	Test Description	Minimum Spec	Result			Maximum Spec	Measurement Uncertainty
1.	Insertion Loss Variation with Rotation of $\lambda/4$ and $\lambda/2$ Plates						
	Wavelength		Maximum Power	Minimum Power	Difference		
	1470 nm		-32.401 dBm	-32.421 dBm	0.060 dB _{pp}	0.060 dB _{pp}	
	1510 nm		-32.510 dBm	-32.539 dBm	0.019 dB _{pp}	0.060 dB _{pp}	
	1540 nm		-32.444 dBm	-32.465 dBm	0.021 dB _{pp}	0.060 dB _{pp}	
	1560 nm		-32.506 dBm	-32.526 dBm	0.060 dB _{pp}	0.060 dB _{pp}	

Insertion Loss versus Wavelength

- 1 Make sure all the connectors you will be using are clean.
- 2 Set up the hardware as shown in Figure D-1.
 - For option #020 _rst splice a Keysight 81102BC patchcord to the pigtail of the Pol-port
 - Make sure that all instruments have warmed up.
 - Fix all cables with tape so that they won't move during measurements.
- 3 Set up the 8153A.
 - a Zero the 8153A: press **ZERO**.
 - b Set 8153A to dBm : press **dBm/W** until display shows dBm.
 - c Set 8153A to 1 sec measuring time: press **param** until T is shown, set T to 200ms by using the Modify keys.
 - d Set 8153A to wavelength=1470 nm: press **param** until λ is shown, set λ to 1470 by using the Modify keys.
- 4 Set up the 8168C.
 - a Press **Wavelength**, press **Edit**, type 1470.000 on the numeric keys, press **Enter**.
 - b Press **Output Power**, press **Edit**, type 100 on the numeric keys, press **Enter**.
 - c Activate the 8168C.
- 5 Set up the 8169A.
 - a Set 8169A to Pol=0 (home position): press **Home**.
 - b Select the "Circle" application: press **Circle**.
- 6 Optimize transmission through 8169A:
 - a Set the polarizing _lter for maximum transmission (see "Setting the Position of the Polarizing Filter" in Chapter 2).
 - b On 8169A set to $2 \epsilon_B$ and get maximum displayed power on 8153A by turning knob.
 - c On 8169A set to $2 \theta_P$ and get maximum displayed power on 8153A by turning knob.

Repeat these two steps until absolute maximum on 8153A display is reached

NOTE

As the display shows negative values, the maximum displayed power is the smallest number displayed

- 7 Note the displayed value on 8153A in your test record in the column "Power after DUT" for the associated wavelength.
- 8 Repeat list item 6 to list item 7 for the wavelengths between 1480 to 1570 nm in steps of 10 nm, always setting the 8168C and the 8153A to the required wavelength for each setting.
- 9 Repeat list item 6 to list item 7 again for 1470 nm to ensure stability of measurement setup. If your measured value is more than .01dB off the previous value, you need to fix your setup and repeat list item 3 to list item 8.
- 10 Connect the 8168C's output to the 81524A Optical Head as shown in **Figure 26**

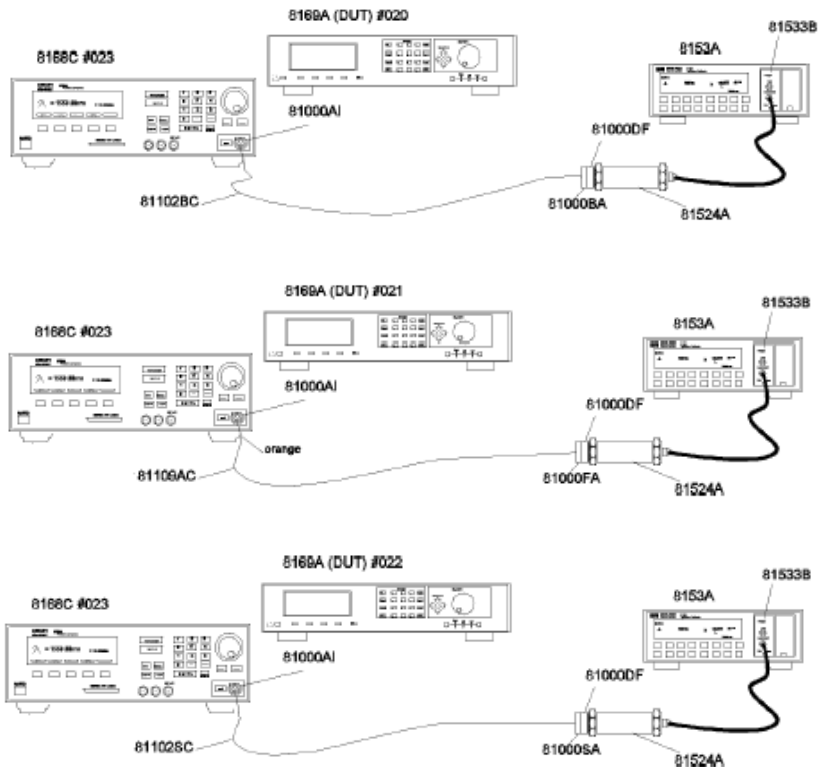

Figure 26 Test Setup for Measuring the Reference Power If you're testing an option #020 you need to cut the spliced patchcords first

- 11 Set 8168C to the wavelength to 1470nm, Output Power to 100 mW.

12 Set the 8153A to wavelength 1470nm.

13 Note the displayed power on 8153A in your test records in the column "Reference Power" for the associated wavelength.

14 Repeat list item 11 to list item 13 for the wavelengths from 1480 to 1570nm in steps of 10nm, always setting the 8168C and the 8153A to the required wavelength.

15 Repeat list item 11 to list item 13 again for wavelength 1470 nm to ensure stability of measurement setup. If your measured value is more than .01 dB off the previous value you need to fix your setup and repeat list item 11 to list item 15.

16 Calculate "Insertion Loss" as difference of "Reference Power"- "Power after DUT" and note the values in the associated column for each wavelength.

17 Check your calculations of "Insertion Loss" for the maximum and minimum value and note the values on the associated lines. The maximum value applies for Maximum Insertion Loss specification.

18 Calculate the difference of maximum and minimum value as the result of "Variation of Insertion Loss with Wavelength".

Example

Table 24

Test No.	Test Description	Minimum Spec.	Result			Maximum Spec.	Measurement Uncertainty
2	Insertion Loss versus Wavelength						
	Wavelength		Reference Power	Power after DUT	Insertion Loss		
	1470 nm		-30.240 dBm	-31.500 dBm	1.350 dB		
	1480 nm		-29.715 dBm	-30.965 dBm	1.250 dB		
	1490 nm		-29.960 dBm	-31.326 dBm	1.366 dB		
	1500 nm		-30.265 dBm	-31.326 dBm	1.332 dB		
	1510 nm		-28.872 dBm	-30.188 dBm	1.316 dB		
	1520 nm		-29.915 dBm	-31.254 dBm	1.339 dB		
	1530 nm		-30.431 dBm	-31.727 dBm	1.296 dB		
	1540 nm		-29.304 dBm	-30.740 dBm	1.346 dB		
	1550 nm		-29.601 dBm	-30.984 dBm	1.333 dB		
	1560 nm		-30.345 dBm	-32.661 dBm	1.316 dB		
	1570 nm		-30.133 dBm	-31.466 dBm	1.333 dB		
			Maximum Insertion Loss		1.366 dB	1.5 dB	
			Minimum Insertion Loss		1.296 dB		
			Difference		0.070 dB _{pp}		
			- variation of insertion loss				
			with Wavelength		0.07 dB _{pp}	0.2 dB _{pp}	_____dB

Extinction Ratio of Polarizer

- 1 Make sure all the connectors you will be using are clean.
- 2 Setup the equipment as shown in [Figure 27](#) .

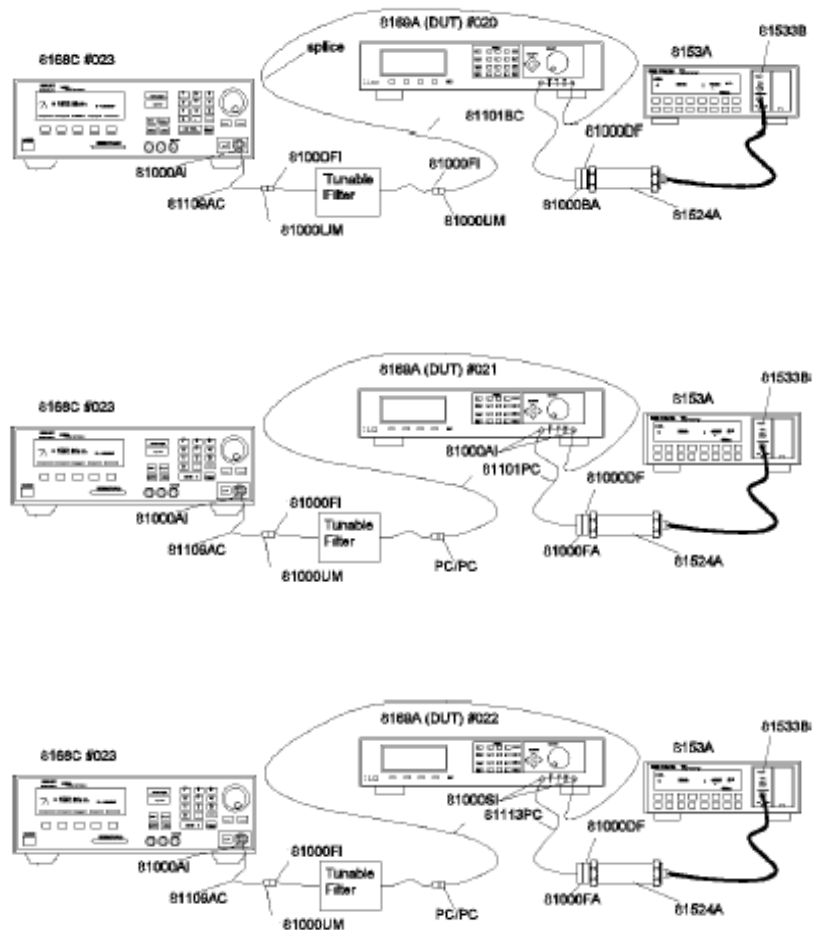

Figure 27 Test Setup for Measuring the Extinction Ratio

- For option #020 first splice a Keysight 81101BC patchcord to the pigtail of the $\lambda/2$ -port
- Make sure that all instruments have warmed up.
- Fix all cables with tape so that they won't move during measurements.

- 3 Set up the 8153A:
 - a Zero the 8153A: press **ZERO**.
 - b Set 8153A to Auto ranging: press **Auto**.
 - c Set wavelength to 1470nm: press **Param** until _ appears use Modify keys to set the appropriate I value.
 - d Set display to dB: press **dB**.
 - e Set to averaging time 50ms: press **Param** until T appears use Modify keys to set the appropriate T value.

- 4 Set up 8168C:
 - a Set wavelength to 1470nm : press **Wavelength**, type "1470", press **Enter**.
 - b Set power to 400 μ W: press **Output Power**, type "400", press **Enter**.
 - c Activate Optical Output.

- 5 Set up the 8169A:
 - a Set to Home position: press **Home**.

- 6 Adjust the tunable filter to get maximum transmission: 8153A display shall show maximum reading (minimum value at negative sign).

- 7 Set 8169A (DUT) to maximum transmission:
 - a Set the polarizing filter for maximum transmission (see "Setting the Position of the Polarizing Filter" in Chapter 2).
 - b Set 8169A (DUT) to Circle: press **Circle**.
 - c Select $2 \theta_P$ and turn the knob to get maximum reading on 8153A display.
 - d Select $2 \epsilon_B$ and turn knob to get maximum reading on 8153A display.

- 8 On the 8153A: press **Disp->Ref**.

- 9 Add 180 degrees to displayed value of $2 \epsilon_B$ and enter this value: type new value, press **Enter**.

- 10 Set 8169A (DUT) to minimum transmission:
 - a Select $2 \theta_P$ and turn the knob to get minimum reading on 8153A display (maximum value at negative sign).
 - b Select $2 \epsilon_B$ and turn the knob to get minimum reading on 8153A display.

You should repeat this step several times using the smallest step size when turning the knob.

The Extinction Ratio is the absolute maximum of any measured value (without the negative sign)

NOTE

The maximum measured value is one that might only occur momentarily and after several tries because of random position changes, that is, you need to approach the "minimum position" from both sides, for both parameters several times.

11 Note the measured result in your test record

12 Repeat list item 6 to list item 11 for 1510nm, 1530 nm and 1560 nm. Always change wavelength setting on all instruments of the test setup, and make sure to optimize the maximum transmission of the filter.

Example

Table 25

Test No.	Test Description	Minimum Spec.	Result	Maximum Spec.	Measurement Certainty
3	Extinction Ratio				
	Wavelength		Extinction Ratio		
	1470 nm	40 dB	43.5 dB		
	1510 nm	45 dB	48.2 dB		
	1530 nm	45 dB	50.6 dB		
	1560 nm	40 dB	44.5 dB		

Table 26

Performance Test for the Keysight 8169A			
Test Facility:			
		Report No. _____	
		Date _____	
		Customer _____	
		Tested By _____	
Model	Keysight 8169A Polarization Controller		
Serial No.		Ambient temperature _____ °C	
Options		Relative humidity _____ %	
Firmware Rev.		Line frequency _____ Hz	
Special Notes:	_____		

Table 27

Performance Test for the Keysight 8169A Option 020		Test Equipment Used		
Page 2 of 3				
	Description	Model No.	Trace No	Cal. Due Date
1	Tunable Laser Source	8168C #023	_____	___/___/___
2	Lightwave Multimeter	8153A	_____	___/___/___
3	Optical Head Interface	81533B	_____	___/___/___
4	Optical Head	81524A	_____	___/___/___
5	Depolarizing Filter	81000DF		
6	Bare Fiber Adapter	81000BA		
7	Diamond HMS-10 Connector Interface	81000AI		
8	FC/PC Connector Interface	81000FI (2 of)		

Table 27

9	Universal Through Adapter	81000UM (2 of)		
10	Diamond HMS-10/HP/HRL Diamond HSMS.10/HP Patchcord	81109AC		
11	Diamond HMS-10/HP Bare Fiber Patchcord	81101BC		
12	Diamond HMS-10/HP/HRL Bare Fiber Patchcord	81102BC		
13	Diamond HMS-10/HP PC Patchcord	81101PC		
14	Tunable Filter	TECOS IFOS-1560CW		
15	_____	_____	_____	_____
16	_____	_____	_____	_____
17	_____	_____	_____	_____
18	_____	_____	_____	_____

Table 28

Performance Test for the Keysight 8169A Polarization Controller Option 020						
Model Keysight 8169A Polarization Controller Option 020		Report No. _____			Date _____	
Test No.	Test Description	Min. Spec.	Result		Max. Spec.	Measurement Uncertainty
I	Insertion Loss Variation with Rotation of N/4 and N/2 Plates					
	Wavelength		Maximum	Minimum	Difference	
			Power	Power		
	1470nm		__dBm	__dBm	____dBpp	0.060dBpp
	1510nm		__dBm	__dBm	____dBpp	0.060dBpp
	1540nm		__dBm	__dBm	____dBpp	0.060dBpp
	1560nm		__dBm	__dBm	____dBpp	0.060dBpp

Table 29

Performance Test for the Keysight 8169A Polarization Controller Option 020						
Model Keysight 8169A Polarization Controller Option 020		Report No. _____			Date _____	
Test No.	Test Description	Min. Spec.	Result		Max. Spec.	Measurement Uncertainty
II	Insertion Loss versus Wavelength					

Table 29

Wavelength	Reference Power	Power after DUT	Insertion Loss		
1470nm	__ dBm	__ dBm	___ dB		
1480nm	__ dBm	__ dBm	___ dB		
1490nm	__ dBm	__ dBm	___ dB		
1500nm	__ dBm	__ dBm	___ dB		
1510nm	__ dBm	__ dBm	___ dB		
1520nm	__ dBm	__ dBm	___ dB		
1530nm	__ dBm	__ dBm	___ dB		
1540nm	__ dBm	__ dBm	___ dB		
1550nm	__ dBm	__ dBm	___ dB		
1560nm	__ dBm	__ dBm	___ dB		
			Maximum Insertion Loss ___ dB		
			Minimum Insertion Loss ___ dB		
			Difference _____ dBpp		
			- variation of insertion loss		
			with Wavelength _____ dBpp		_____ dBpp

Table 30

Performance Test for the Keysight 8169A Polarization Controller Option 020					
Model Keysight 8169A Polarization Controller Option 020		Report No. _____		Date _____	
Test No.	Test Description	Min. Spec.	Result	Max. Spec.	Measurement Uncertainty
III	Extinction Ratio				
	Wavelength	Extinction Ratio			
		_____ dB			
	1470nm	_____ dB			
	1510nm	_____ dB			
	1530nm	_____ dB			
	1560nm				

12

Cleaning Information

Safety Precautions.....	135
Why is it important to clean optical devices?	136
What materials do I need for proper cleaning?	137
Standard Cleaning Equipment	137
Additional Cleaning Equipment	140
Preserving Connectors	142
Cleaning Instrument Housings	143
General Cleaning Procedure.....	144
How to clean connectors.....	144
How to clean optical head adapters	146
How to clean connector interfaces	147
How to clean bare fiber adapters.....	147
How to clean lenses and instruments with an optical glass plate 148	
How to clean instruments with a fixed connector interface .	149
How to clean instruments with a physical contact interface	150
How to clean instruments with a recessed lens interface	153
How to clean optical devices which are sensitive to mechanical stress and pressure	154
How to clean metal filters or attenuator gratings	154
Additional Cleaning Information	156
How to clean bare fiber ends	156
How to clean large area lenses and mirrors.....	156
Other Cleaning Hints	159

Cleaning Information

The following Cleaning Information contains some general safety precautions, which must be observed during all phases of cleaning. Consult your specific optical device manuals or guides for full information on safety matters.

Please try, whenever possible, to use physically contacting connectors, and dry connections. Clean the connectors, interfaces, and bushings carefully after use.

If you are unsure of the correct cleaning procedure for your optical device, we recommend that you first try cleaning a dummy or test device.

Keysight Technologies assume no liability for the customer's failure to comply with these requirements.

Safety Precautions

Please follow the following safety rules:

- Do not remove instrument covers when operating.
- Ensure that the instrument is switched off throughout the cleaning procedures.
- Use of controls or adjustments or performance of procedures other than those specified may result in hazardous radiation exposure.
- Make sure that you disable all sources when you are cleaning any optical interfaces.
- Under no circumstances look into the end of an optical device attached to optical outputs when the device is operational. The laser radiation is not visible to the human eye, but it can seriously damage your eyesight.
- To prevent electrical shock, disconnect the instrument from the mains before cleaning. Use a dry cloth, or one slightly dampened with water, to clean the external case parts. Do not attempt to clean internally.
- Do not install parts or perform any unauthorized modification to optical devices.
- Refer servicing only to qualified and authorized personnel.

Why is it important to clean optical devices?

CAUTION

Optical power levels above 100 mW applied to single mode connectors can easily damage the connector if it is not perfectly clean. Also, scratched or poorly cleaned connectors can destroy optical connectors mechanically. Always make sure that your optical connectors are properly cleaned and unscratched before connection. However, Keysight Technologies Deutschland GmbH assumes no responsibility in case of an operation that is not comply with the safety instructions as stated above.

In transmission links optical fiber cores are about 9 μm (0.00035") in diameter. Dust and other particles, however, can range from tenths to hundredths of microns in diameter. Their comparative size means that they can cover a part of the end of a fiber core, and thus degrade the transmission quality. This will reduce the performance of your system.

Furthermore, the power density may burn dust into the fiber and cause additional damage (for example, 0 dBm optical power in a single mode fiber causes a power density of approximately 16 million W/m^2). If this happens, measurements become inaccurate and non-repeatable.

Cleaning is, therefore, an essential yet difficult task. Unfortunately, when comparing most published cleaning recommendations, you will discover that they contain several inconsistencies. In this chapter, we want to suggest ways to help you clean your various optical devices, and thus significantly improve the accuracy and repeatability of your lightwave measurements.

What materials do I need for proper cleaning?

Some **Standard Cleaning Equipment** is necessary for cleaning your instrument. For certain cleaning procedures, you may also require certain **Additional Cleaning Equipment**.

Standard Cleaning Equipment

Before you can start your cleaning procedure you need the following standard equipment:

- **Dust and shutter caps**
- **Isopropyl alcohol**
- **Cotton swabs**
- **Soft tissues**
- **Pipe cleaner**
- **Compressed air**

Dust and shutter caps

All of Keysight Technologies' lightwave instruments are delivered with either laser shutter caps or dust caps on the lightwave adapter. Any cables come with covers to protect the cable ends from damage or contamination.

We suggest these protective coverings should be kept on the equipment at all times, except when your optical device is in use. Be careful when replacing dust caps after use. Do not press the bottom of the cap onto the fiber too hard, as any dust in the cap can scratch or pollute your fiber surface.

If you need further dust caps, please contact your nearest Keysight Technologies sales office.

Isopropyl alcohol

This solvent is usually available from any local pharmaceutical supplier or chemist's shop. Results will vary depending on the purity of the alcohol.

If you use isopropyl alcohol to clean your optical device, do not immediately dry the surface with compressed air (except when you are cleaning very sensitive optical devices). This is because the dust and the dirt is dissolved in the alcohol and will leave behind filmy deposits after the alcohol has evaporated. You should therefore first remove the alcohol and the dust with a soft tissue, and then use compressed air to blow away any remaining filaments.

If possible avoid using denatured alcohol containing additives. Instead, apply alcohol used for medical purposes.

Never drink this alcohol, as it may seriously damage to your health.

Do not use any other solvents, as some may damage plastic materials and claddings. Acetone, for example, will dissolve the epoxy used with fiber optic connectors. To avoid damage, only use isopropyl alcohol.

Cotton swabs

We recommend that you use swabs such as Q-tips or other cotton swabs normally available from local distributors of medical and hygiene products (for example, a supermarket or a chemist's shop). You may be able to obtain various sizes of swab. If this is the case, select the smallest size for your smallest devices.

Ensure that you use natural cotton swabs. Foam swabs will often leave behind filmy deposits after cleaning.

Use care when cleaning, and avoid pressing too hard onto your optical device with the swab. Too much pressure may scratch the surface, and could cause your device to become misaligned. It is advisable to rub gently over the surface using only a small circular movement.

Swabs should be used straight out of the packet, and never used twice. This is because dust and dirt in the atmosphere, or from a first cleaning, may collect on your swab and scratch the surface of your optical device.

Soft tissues

These are available from most stores and distributors of medical and hygiene products such as supermarkets or chemists' shops.

We recommend that you do not use normal cotton tissues, but multi-layered soft tissues made from non-recycled cellulose. Cellulose tissues are very absorbent and softer. Consequently, they will not scratch the surface of your device over time.

Use care when cleaning, and avoid pressing on your optical device with the tissue. Pressing too hard may lead to scratches on the surface or misalignment of your device. Just rub gently over the surface using a small circular movement.

Use only clean, fresh soft tissues and never apply them twice. Any dust and dirt from the air which collects on your tissue, or which has gathered after initial cleaning, may scratch and pollute your optical device.

Pipe cleaner

Pipe cleaners can be purchased from tobacconists, and come in various shapes and sizes. The most suitable one to select for cleaning purposes has soft bristles, which will not produce scratches.

The best way to use a pipe cleaner is to push it in and out of the device opening (for example, when cleaning an interface). While you are cleaning, you should slowly rotate the pipe cleaner.

Only use pipe cleaners on connector interfaces or on feed through adapters. Do not use them on optical head adapters, as the center of a pipe cleaner is hard metal and can damage the bottom of the adapter.

Your pipe cleaner should be new when you use it. If it has collected any dust or dirt, this can scratch or contaminate your device.

The tip and center of the pipe cleaner are made of metal. Avoid accidentally pressing these metal parts against the inside of the device, as this can cause scratches.

Compressed air

Compressed air can be purchased from any laboratory supplier.

It is essential that your compressed air is free of dust, water and oil. Only use clean, dry air. If not, this can lead to filmy deposits or scratches on the surface of your connector. This will reduce the performance of your transmission system.

When spraying compressed air, hold the can upright. If the can is held at a slant, propellant could escape and dirty your optical device. First spray into the air, as the initial stream of compressed air could contain some condensation or propellant. Such condensation leaves behind a filmy deposit.

Please be friendly to your environment and use a CFC-free aerosol.

Additional Cleaning Equipment

Some Cleaning Procedures need the following equipment, which is not required to clean each instrument:

- Microscope with a magnification range about 50X up to 300X
- Ultrasonic bath
- Warm water and liquid soap
- Premoistened cleaning wipes
- Polymer film
- Infrared Sensor Card

Microscope with a magnification range about 50X up to 300X

A microscope can be found in most photography stores, or can be obtained through or specialist mail order companies. Special fiber-scopes are available from suppliers of splicing equipment.

Ideally, the light source on your microscope should be very flexible. This will allow you to examine your device closely and from different angles.

A microscope helps you to estimate the type and degree of dirt on your device. You can use a microscope to choose an appropriate cleaning method, and then to examine the results. You can also use your microscope to judge whether your optical device (such as a connector) is severely scratched and is, therefore, causing inaccurate measurements.

Ultrasonic bath

Ultrasonic baths are also available from photography or laboratory suppliers or specialist mail order companies.

An ultrasonic bath will gently remove fat and other stubborn dirt from your optical devices. This helps increase the life span of the optical devices.

Only use isopropyl alcohol in your ultrasonic bath, as other solvents may cause damage.

Warm water and liquid soap

Only use water if you are sure that there is no other way of cleaning your optical device without causing corrosion or damage. Do not use hot water, as this may cause mechanical stress, which can damage your optical device.

Ensure that your liquid soap has no abrasive properties or perfume in it. You should also avoid normal washing up liquid, as it can cover your device in an iridescent film after it has been air dried.

Some lenses and mirrors also have a special coating, which may be sensitive to mechanical stress, or to fat and liquids. For this reason we recommend you do not touch them.

If you are not sure how sensitive your device is to cleaning, please contact the manufacturer or your sales distributor.

Premoistened cleaning wipes

Use pre-moistened cleaning wipes as described in each individual cleaning procedure. Cleaning wipes may be used in every instance where a moistened soft tissue or cotton swab is applied.

Polymer film

Polymer film is available from laboratory suppliers or specialist mail order companies.

Using polymer film is a gentle method of cleaning extremely sensitive devices, such as reference reflectors and mirrors.

Infrared Sensor Card

Infrared sensor cards are available from laboratory suppliers or specialist mail order companies.

With the help of this card you are able to inspect the shape of laser light emitted. The invisible laser beam is projected onto the sensor card. The light beam's infrared wavelengths are reflected at visible wavelengths, so becoming visible to the normal eye as a round spot.

Take care never to look into the end of a fiber or any other optical component, when they are in use. This is because the laser can seriously damage your eyes.

Preserving Connectors

Listed below are some hints on how best to keep your connectors in the best possible condition.

Making Connections

Before you make any connection you must ensure that all cables and connectors are clean. If they are dirty, use the appropriate cleaning procedure.

When inserting the ferrule of a patchcord into a connector or an adapter, make sure that the fiber end does not touch the outside of the mating connector or adapter. Otherwise you will rub the fiber end against an unsuitable surface, producing scratches and dirt deposits on the surface of your fiber.

Dust Caps and Shutter Caps

Be careful when replacing dust caps after use. Do not press the bottom of the cap onto the fiber as any dust in the cap can scratch or dirty your fiber surface.

When you have finished cleaning, put the dust cap back on, or close the shutter cap if the equipment is not going to be used immediately.

Always keep the caps on the equipment when it is not in use.

All of Keysight Technologies' lightwave instruments and accessories are shipped with either laser shutter caps or dust caps. If you need additional or replacement dust caps, contact your nearest Keysight Technologies Sales/Service Office.

Immersion Oil and Other Index Matching Compounds

Wherever possible, do not use immersion oil or other index matching compounds with your device. They are liable to impair and dirty the surface of the device. In addition, the characteristics of your device can be changed and your measurement results affected.

Cleaning Instrument Housings

Use a dry and very soft cotton tissue to clean the instrument housing and the keypad. Do not open the instruments as there is a danger of electric shock, or electrostatic discharge. Opening the instrument can cause damage to sensitive components, and in addition your warranty will be invalidated.

General Cleaning Procedure

Light dirt

If you just want to clean away light dirt, observe the following procedure for all devices:

- Use compressed air to blow away large particles.
- Clean the device with a dry cotton swab.
- Use compressed air to blow away any remaining filament left by the swab.

Heavy dirt

If the above procedure is not enough to clean your instrument, follow one of the procedures below.

If you are unsure of how sensitive your device is to cleaning, please contact the manufacturer or your sales distributor

How to clean connectors

Cleaning connectors is difficult as the core diameter of a single mode fiber is only about 9 μ m. This generally means you cannot see streaks or scratches on its surface. To be certain of the condition of the surface of your connector and to check it after cleaning, you need a microscope.

In the case of scratches, or of dust that has been burnt onto the surface of the connector, you may have no option but to polish the connector. This depends on the degree of dirtiness, or the depth of the scratches. This is a difficult procedure and should only be performed by a skilled person, and as a last resort as it wears out your connector.

WARNING

Never look into the end of an optical cable that is connected to an active source.

To assess the projection of the emitted light beam you can use an infrared sensor card. Hold the card approximately 5 cm from the output of the connector. The invisible emitted light is projected onto the card and becomes visible as a small circular spot.

Cleaning procedure for high-power single mode connections

Optical single mode connectors for high-power applications (optical power levels above 100 mW) require careful cleaning to prevent the power density of burning dust or dirt into the fiber causing permanent damage to the devices and/or connectors. If this happens, measurements become inaccurate and unrepeatable.

The “Preferred Procedure” on page 145 or the “Procedure for Stubborn Dirt” on page 145 must be strictly followed for each part of the optical connection (connector, connector interface, and physical connector interface).

Always make sure that the fiber end-faces are properly cleaned and unscratched before connection. The fiber end faces must be visually inspected using a microscope with a magnification of at least 400x. For recommended fiber inspection microscopes, please refer to personnel in Keysight’s Service Team.

The connection should be made immediately after cleaning and inspection to prevent the connection (connector, connector interface, and physical connector interface) from becoming dusty or dirty again.

Preferred Procedure

An Optical Connector Cleaner, which resembles a VCR cleaning tape, is a device that can be used to clean grease from the surface of a connector.

- 1 Blow away any surface dust with compressed air..
- 2 Press the button on the side of the Optical Connector Cleaner device to ensure that a fresh strip of tape is ready.
- 3 Position the connector interface on the tape.
- 4 Holding the connector interface against the tape, rotate the interface about 180 degrees, then slide it across the surface of the tape.

Alternative Procedure

Use the following procedure if an Optical Connector Cleaner is not available.

- 1 Clean the connector by rubbing a new, dry cotton swab over the surface using a small circular movement.
- 2 Blow away any remaining lint with compressed air.

Procedure for Stubborn Dirt

Use this procedure when there is greasy dirt on the connector:

- 1 Moisten a new cotton swab with isopropyl alcohol.
- 2 Clean the connector by rubbing the cotton swab over the surface using a small

circular movement.

- 3 Take a new, dry soft tissue and remove the alcohol, dissolved sediment and dust, by rubbing gently over the surface using a small circular movement.
- 4 Blow away any remaining lint with compressed air.

An Alternative Procedure

A better, more gentle, but more expensive cleaning procedure is to use an ultrasonic bath with isopropyl alcohol.

- 1 Hold the tip of the connector in the bath for at least three minutes.
- 2 Take a new, dry soft tissue and remove the alcohol, dissolved sediment and dust, by rubbing gently over the surface using a small circular movement.
- 3 Blow away any remaining lint with compressed air.

How to clean optical head adapters

CAUTION

Some adapters have an anti-reflection coating on the back to reduce back reflection. This coating is extremely sensitive to solvents and mechanical abrasion. Extra care is needed when cleaning these adapters.

When using optical head adapters, periodically inspect the optical head's front window. Dust and metal particles can be propelled through the adapter's pinhole while inserting the connector ferrule into the receptacle. These dirt particles collect on the head's front window, which can lead to incorrect results if not removed.

Preferred Procedure

Use the following procedure on most occasions.

- 1 Clean the adapter by rubbing a new, dry cotton swab over the surface using a small circular movement.
- 2 Blow away any remaining lint with compressed air.

Procedure for Stubborn Dirt

Use this procedure when there is greasy dirt on the adapter:

- 1 Moisten a new cotton swab with isopropyl alcohol.
- 2 Clean the adapter by rubbing the cotton swab over the surface using a small circular movement.

- 3 Take a new, dry soft tissue and remove the alcohol, dissolved sediment and dust, by rubbing gently over the surface using a small circular movement.
- 4 Blow away any remaining lint with compressed air.

How to clean connector interfaces

CAUTION

Be careful when using pipe cleaners, as the core and the bristles of the pipe cleaner are hard and can damage the interface.

Do not use pipe cleaners on optical head adapters, as the hard core of normal pipe cleaners can damage the bottom of an adapter.

Preferred Procedure

Use the following procedure on most occasions.

- 1 Clean the interface, when no lens is connected, by pushing and pulling a new, dry pipe cleaner into the opening. Rotate the pipe cleaner slowly as you do this.
- 2 Blow away any remaining lint with compressed air.

Procedure for Stubborn Dirt

Use this procedure when there is greasy dirt on the interface:

- 1 Moisten a new pipe cleaner with isopropyl alcohol.
- 2 Clean the interface by pushing and pulling the pipe cleaner into the opening. Rotate the pipe cleaner slowly as you do this.
- 3 Using a new, dry pipe cleaner, and a new, dry cotton swab remove the alcohol, any dissolved sediment and dust.
- 4 Blow away any remaining lint with compressed air.

How to clean bare fiber adapters

Bare fiber adapters are difficult to clean. Protect from dust unless they are in use.

CAUTION

Never use any kind of solvent when cleaning a bare fiber adapter as solvents can:

- Damage the foam inside some adapters.
 - Deposit dissolved dirt in the groove, which can then dirty the surface of an inserted fiber.
-

Preferred Procedure

Use the following procedure on most occasions.

- 1 Blow away any dust or dirt with compressed air.

Procedure for Stubborn Dirt

Use this procedure when there is greasy dirt on the adapter:

- 1 Clean the adapter by pushing and pulling a new, dry pipe cleaner into the opening. Rotate the pipe cleaner slowly as you do this.

CAUTION

Be careful when using pipe cleaners, as the core and the bristles of the pipe cleaner are hard and can damage the adapter.

-
- 2 Clean the adapter by rubbing a new, dry cotton swab over the surface using a small circular movement.
 - 3 Blow away any remaining lint with compressed air.

How to clean lenses and instruments with an optical glass plate

Some lenses have special coatings that are sensitive to solvents, grease, liquid and mechanical abrasion. Take extra care when cleaning lenses with these coatings. Some instruments, for example, Keysight's optical heads have an optical glass plate to protect the sensor.

CAUTION

Do not attempt to access the internal parts of a Keysight N3988A video microscope for cleaning or for any other purpose.

Lens assemblies consisting of several lenses are not normally sealed. Therefore, use as little alcohol as possible, as it can get between the lenses and in doing so can change the properties of projection.

If you are cleaning a Keysight 8162*A optical head, periodically inspect the optical head's front window for dust and other particles. Dust and particles can be propelled through the optical head adapter's pinhole while inserting a connector ferrule into the receptacle. Particles on the optical head's front window can significantly impair measurement results.

NOTE

Do not dry the lens by rubbing with with cloth or other material, which may scratch the lens surface.

Preferred Procedure

Use the following procedure on most occasions.

- 1 Clean the lens by rubbing a new, dry cotton swab over the surface using a small circular movement.
- 2 Blow away any remaining lint with compressed air.

Procedure for Stubborn Dirt

Use this procedure when there is greasy dirt on the lens:

- 1 Moisten a new cotton swab with isopropyl alcohol.
- 2 Clean the lens by rubbing the cotton swab over the surface using a small circular movement.
- 3 Using a new, dry cotton swab remove the alcohol, any dissolved sediment and dust.
- 4 Blow away any remaining lint with compressed air.

How to clean instruments with a fixed connector interface

You should only clean instruments with a fixed connector interface when it is absolutely necessary. This is because it is difficult to remove any used alcohol or filaments from the input of the optical block.

It is important, therefore, to keep dust caps on the equipment at all times, except when your optical device is in use.

If you do discover filaments or particles, the only way to clean a fixed connector interface and the input of the optical block is to use compressed air.

If there are fluids or fat in the connector, please refer the instrument to the skilled personnel of Keysight's service team.

NOTE

Both the surface and the jacket of the attached connector should be completely dry and clean.

CAUTION

Only use clean, dry compressed air. Make sure that the air is free of dust, water, and oil. If the air that you use is not clean and dry, this can lead to filmy deposits or scratches on the surface of your connector interface. This will degrade the performance of your transmission system.

Never try to open the instrument and clean the optical block by yourself, because it is easy to scratch optical components, and cause them to become misaligned.

How to clean instruments with a physical contact interface

Remove any connector interfaces from the optical output of the instrument before you begin the cleaning procedure.

Cleaning interfaces is difficult as the core diameter of a single mode fiber is only about 9 mm. This generally means you cannot see streaks or scratches on the surface. To be certain of the degree of pollution on the surface of your interface and to check whether it has been removed after cleaning, you need a microscope.

WARNING

Never look into an optical output, because this can seriously damage your eyesight.

To assess the projection of the emitted light beam you can use an infrared sensor card. Hold the card approximately 5 cm from the interface. The invisible emitted light is projected onto the card and becomes visible as a small circular spot.

Optical single mode connections for high-power applications (optical power levels above 100mW) require careful cleaning to prevent the power density of burning dust or dirt into the fiber causing permanent damage of the devices and/or connectors. If this happens, measurements become inaccurate and non-repeatable.

Preferred Procedure

Use the following procedure on most occasions.

- 1 Clean the interface by rubbing a new, dry cotton swab over the surface using a small circular movement.
- 2 Blow away any remaining lint with compressed air.

Procedure for Stubborn Dirt

Use this procedure when there is greasy dirt on the interface:

- 1 Moisten a new cotton swab with isopropyl alcohol.
- 2 Clean the interface by rubbing the cotton swab over the surface using a small circular movement.
- 3 Take a new, dry soft tissue and remove the alcohol, dissolved sediment and dust, by rubbing gently over the surface using a small circular movement.
- 4 Blow away any remaining lint with compressed air.

NOTE

This procedures must be strictly followed for each part of the optical connection (connector, connector interface and physical connector interface).

NOTE

The connection should be made immediately after cleaning and inspection to prevent the connection (connector, connector interface and physical connector interface) from getting dusty or dirty again.

NOTE

Always make sure that the fiber end faces are properly cleaned and unscratched before connection. The fiber end faces must be visually inspected using a microscope with a magnification of at least 400x. For recommended fiber inspection microscopes, please refer to Keysight 's service team personnel.

How to clean instruments with a recessed lens interface

For instruments with a *deeply* recessed lens interface (for example the Keysight 81633A and 81634A Power Sensors) do NOT follow this procedure. Alcohol and compressed air could damage your lens even further.

Keep your dust and shutter caps on when your instrument is not in use. This should prevent it from getting too dirty.

If you must clean such instruments, please refer the instrument to the skilled personnel of Keysight's service team.

Preferred Procedure

Use the following procedure on most occasions.

- 1 Blow away any dust or dirt with compressed air.
If this is not sufficient, then
 - a Clean the interface by rubbing a new, dry cotton swab over the surface using a small circular movement.
 - b Blow away any remaining lint with compressed air.

Procedure for Stubborn Dirt

Use this procedure when there is greasy dirt on the interface, and using the preferred procedure is not sufficient.

Using isopropyl alcohol should be your last choice for recessed lens interfaces because of the difficulty of cleaning out any dirt that is washed to the edge of the interface.

- 1 Moisten a new cotton swab with isopropyl alcohol.
- 2 Clean the interface by rubbing the cotton swab over the surface using a small circular movement.
- 3 Take a new, dry soft tissue and remove the alcohol, dissolved sediment and dust, by rubbing gently over the surface using a small circular movement.
- 4 Blow away any remaining lint with compressed air.

How to clean optical devices which are sensitive to mechanical stress and pressure

Some optical devices, such as the Keysight 81000BR Reference Reflector, which has a gold plated surface, are very sensitive to mechanical stress or pressure. Do not use cotton swabs, soft tissues or other mechanical cleaning tools, as these can scratch or destroy the surface.

Preferred Procedure

Use the following procedure on most occasions.

- 1 Blow away any dust or dirt with compressed air.

Procedure for Stubborn Dirt

To clean devices that are extremely sensitive to mechanical stress or pressure you can also use an optical clean polymer film. This procedure is time-consuming, but you avoid scratching or destroying the surface.

- 1 Put the film on the surface and wait at least 30 minutes to make sure that the film has had enough time to dry.
- 2 Remove the film and any dirt with special adhesive tapes.

Alternative Procedure

For these types of optical devices you can often use an ultrasonic bath with isopropyl alcohol. Only use the ultrasonic bath if you are sure that it won't cause any damage any part of the device.

- 1 Put the device into the bath for at least three minutes.
- 2 Blow away any remaining liquid with compressed air.

If there are any streaks or drying stains on the surface, repeat the cleaning procedure.

How to clean metal filters or attenuator gratings

This kind of device is extremely fragile. A misalignment of the grating leads to inaccurate measurements. Never touch the surface of the metal filter or attenuator grating.

Be very careful when using or cleaning these devices. Do not use cotton swabs or soft tissues, as there is the danger that you cannot remove the lint and that the device will be destroyed by becoming mechanically distorted.

Preferred Procedure

Use the following procedure on most occasions.

- 1 Use compressed air at a distance and with low pressure to remove any dust or lint.

Procedure for Stubborn Dirt

Do not use an ultrasonic bath as this can damage your device.

Use this procedure when there is greasy dirt on the device:

- 1 Put the optical device into a bath of isopropyl alcohol, and wait at least 10 minutes.
- 2 Remove the fluid using compressed air at some distance and with low pressure. If there are any streaks or drying stains on the surface, repeat the whole cleaning procedure.

Additional Cleaning Information

The following cleaning procedures may be used with other optical equipment:

- [How to clean bare fiber ends](#)
- [How to clean large area lenses and mirrors](#)

How to clean bare fiber ends

Bare fiber ends are often used for splices or, together with other optical components, to create a parallel beam.

The end of a fiber can often be scratched. You make a new cleave. To do this:

- 1 Strip off the cladding.
- 2 Take a new soft tissue and moisten it with isopropyl alcohol.
- 3 Carefully clean the bare fiber with this tissue.
- 4 Make your cleave and immediately insert the fiber into your bare fiber adapter in order to protect the surface from dirt.

Preferred Procedure

There is an easy method for removing dust from bare fiber ends.

- 1 Touch the bare fiber end with adhesive tape. Any dust will be removed.

How to clean large area lenses and mirrors

Some mirrors, as those from a monochromator, are very soft and sensitive. Therefore, never touch them and do not use cleaning tools such as compressed air or polymer film.

Some lenses have special coatings that are sensitive to solvents, grease, liquid and mechanical abrasion. Take extra care when cleaning lenses with these coatings.

Lens assemblies consisting of several lenses are not normally sealed. Therefore, use as little liquid as possible, as it can get between the lenses and in doing so can change the properties of projection.

Preferred Procedure

Use the following procedure on most occasions.

- 1 Blow away any dust or dirt with compressed air.

Procedure for Stubborn Dirt

Use this procedure when there is greasy dirt on the lens:

CAUTION

Only use water if you are sure that there is no other way of cleaning your optical device without causing corrosion or damage. Do not use hot water, as this may cause mechanical stress, which can damage your optical device.

Ensure that your liquid soap has no abrasive properties or perfume in it. You should also avoid normal washing up liquid, as it can cover your device in an iridescent film after it has been air dried.

Some lenses and mirrors also have a special coating, which may be sensitive to mechanical stress, or to fat and liquids. For this reason we recommend you do not touch them.

If you are not sure how sensitive your device is to cleaning, please contact the manufacturer or your sales distributor.

-
- 1 Moisten the lens or the mirror with water.
 - 2 Put a little liquid soap on the surface and gently spread the liquid over the whole area.
 - 3 Wash off the emulsion with water, being careful to remove it all, as any remaining streaks can impair measurement accuracy.
 - 4 Take a new, dry soft tissue and remove the water, by rubbing gently over the surface using a small circular movement.
 - 5 Blow away remaining lint with compressed air.

Alternative Procedure A

To clean lenses that are extremely sensitive to mechanical stress or pressure you can also use an optical clean polymer film. This procedure is time-consuming, but you avoid scratching or destroying the surface.

- 1 Put the film on the surface and wait at least 30 minutes to make sure that the film has had enough time to dry.
- 2 Remove the film and any dirt with special adhesive tapes.

Alternative Procedure B

If your lens is sensitive to water then:

- 1** Moisten the lens or the mirror with isopropyl alcohol.
- 2** Take a new, dry soft tissue and remove the alcohol, dissolved sediment and dust, by rubbing gently over the surface using a small circular movement.
- 3** Blow away remaining lint with compressed air.

Other Cleaning Hints

Selecting the correct cleaning method is an important element in maintaining your equipment and saving you time and money. This chapter highlights the main cleaning methods, but cannot address every individual circumstance.

This section contain some additional hints which we hope will help you further. For further information, please contact your local Keysight Technologies representative.

Making the connection

Before you make any connection you must ensure that all lightwave cables and connectors are clean. If not, then use the appropriate cleaning methods.

When you insert the ferrule of a patchcord into a connector or an adapter, ensure that the fiber end does not touch the outside of the mating connector or adapter. Otherwise, the fiber end will rub up against something which could scratch it and leave deposits.

Lens cleaning papers

Some special lens cleaning papers are not suitable for cleaning optical devices like connectors, interfaces, lenses, mirrors and so on. To be absolutely certain that a cleaning paper is applicable, please ask the salesperson or the manufacturer.

Immersion oil and other index matching compounds

Do not use immersion oil or other index matching compounds with optical sensors equipped with recessed lenses. They are liable to dirty the detector and impair its performance. They may also alter the property of depiction of your optical device, thus rendering your measurements inaccurate.

Cleaning the housing and the mainframe

When cleaning either the mainframe or the housing of your instrument, only use a dry and very soft cotton tissue on the surfaces and the numeric pad.

Never open the instruments as they can be damaged. Opening the instruments puts you in danger of receiving an electrical shock from your device, and renders your warranty void.

13

Error Messages

Display Messages	162
GPIB Messages	163
Command Errors	163
Execution Errors	165
Device-Specific Errors	166
Query Errors	167

Display Messages

Selftest Errornnnn. shows that the self test has failed. The number nnnn is a four digit hexadecimal number that shows which part of the self test has failed.

Table 31

Bits	Mnemonics	Hexadecimal Value
14	Motor 3	8000 ₁₆
13	Motor 2	4000 ₁₆
12	Motor 1	1000 ₁₆
10	Counter 3	0400 ₁₆
9	Counter 2	0200 ₁₆
8	Counter 1	0100 ₁₆
5	DSP Timeout	0020 ₁₆
4	DSP Communications	0010 ₁₆
3	Calibration Data	0008 ₁₆
1	Battery RAM	0002 ₁₆
0	Calibration Data Checksum	0001 ₁₆

So Selftest Error 0010 would mean that the DSP (Digital Signal Processor) Communications had failed, Selftest Error 12 would mean that the DSP Communications had failed, and so had the Battery RAM. A value of zero shows no errors.

GPIB Messages

Command Errors

These are error messages in the range -100 to -199. They show that a syntax error has been detected by the parser in a command, such as incorrect data, incorrect commands, or misspelled or mistyped commands.

A command error is signaled by the command error bit (bit 5) in the event status register.

- **100 Command error.** This shows that the parser has found a command error but cannot be more specific.
- **101 Invalid character.** The command contains an invalid or unrecognized character.
- **102 Syntax error.** The command or data could not be recognized.
- **103 Invalid separator.** The parser was expecting a separator (for example, a semicolon (;) between commands) but did not find one.
- **104 Data type error.** The parser was expecting one data type, but found another (for example, was expecting a string, but received numeric data).
- **105 GET not allowed.** A Group Execute Trigger was received within a program message (see IEEE 488.2, 7.7)
- **108 Parameter not allowed.** More parameters were received for a command than were expected.
- **109 Missing parameter.** Fewer parameters were received than the command requires.
- **110 Command header error.** A command header is the mnemonic part of the command (the part not containing parameter information. This error shows that the parser has found an error in the command header but cannot be more specific.
- **111 Header separator error.** A character that is not a valid header separator was encountered.
- **112 Program mnemonic too long.** The program mnemonic must be 12 characters or shorter.
- **113 Undefined header.** This header is not defined for use with the instrument.
- **114 Header suffix out of range.** The header contained an invalid character. This message sometimes occurs because the parser is trying to interpret a non-header as a header.

Error Messages

- **120 Numeric data error.** This error shows that the parser has found an error in numeric data (including nondecimal numeric data) but cannot be more specific.
- **121 Invalid character in number.** An invalid character was found in numeric data (note, this may include an alphabetic character in a decimal data, or a \9" in octal data).
- **123 Exponent too large.** The exponent must be less than 32 000.
- **124 Too many digits.** The mantissa of a decimal number can have a maximum of 255 digits (leading zeros are not counted).
- **128 Numeric data not allowed.** Another data type was expected for this command.
- **130 Suffix error.** The suffix is the unit, and the unit multiplier for the data. This error shows that the parser has found an error in suffix but cannot be more specific.
- **131 Invalid suffix.** The suffix is incorrect or inappropriate.
- **134 Suffix too long.** A suffix can have a maximum of 12 characters.
- **138 Suffix not allowed.** A suffix was found where none is allowed.
- **140 Character data error.** This error shows that the parser has found an error in character data but cannot be more specific.
- **141 Invalid character data.** The character data is incorrect or inappropriate.
- **144 Character data too long.** Character data can have a maximum of 12 characters.
- **148 Character data not allowed.** Character data was found where none is allowed.
- **150 String data error.** This error shows that the parser has found an error in string data but cannot be more specific.
- **151 Invalid string data.** The string data is incorrect, (for example, an END message was received before the terminal quote character).
- **158 String data not allowed.** String data was found where none is allowed.
- **160 Block data error.** This error shows that the parser has found an error in block data but cannot be more specific.
- **161 Invalid block data.** The block data is incorrect (for example, an END message was received before the length was satisfied).
- **168 Block data not allowed.** Block data was found where none is allowed.

Execution Errors

These are error messages in the range -200 to -299. They show that an execution error has been detected by the execution control block.

An execution error is signaled by the execution error bit (bit 4) in the event status register.

- **200 Execution error.** This shows that an execution error has occurred but the control block cannot be more specific.
- **201 Invalid while in local.** This command is invalid because it conflicts with the configuration under local control.
- **202 Settings lost due to rtl.** A local setting was lost when the instrument was changing from remote to local control, or from local to remote control.
- **220 Parameter error.** This shows that a parameter error has occurred but the control block cannot be more specific.
- **221 Settings conflict.** A valid parameter was received, but could not be used during execution because of a conflict with the current state of the instrument.
- **222 Data out of range.** The data, though valid, was outside the range allowed by the instrument.
- **223 Too much data.** The block, expression, or string data was too long for the instrument to handle.
- **224 Illegal parameter value.** One value from a list of possible values was expected. The parameter received was not found in the list.
- **240 Hardware error.** Shows that a command could not be executed due to a hardware error but the control block cannot be more specific.
- **241 Hardware missing.** Shows that a command could not be executed because of missing instrument hardware.

Device-Specific Errors

These are error messages in the range -300 to -399, or between 1 and 32767. They show that an error has been detected that is specific to the operation of the polarization controller.

A device-specific error is signaled by the device-speci_c error bit (bit 3) in the event status register.

- **300 Device-specific error.** This shows that a device-specific error has occurred. No more specific information is available.
- **310 System error.** An instrument system error has occurred.
- **311 Memory error.** A memory error has been detected.
- **314 Save/recall memory lost.** The nonvolatile data saved by the *SAV command has been lost.
- **315 Configuration memory lost.** The nonvolatile configuration data saved by the instrument has been lost.
- **330 Self-test failed.** Further information about the self-test failure is available by using *TST?.
- **350 Queue overflow.** The error queue has overflowed. This error is written to the last position in the queue, no further errors are recorded.

Query Errors

These are error messages in the range -400 to -499. They show that an error has been detected by the output queue control.

A device-specific error is signaled by the query error bit (bit 2) in the event status register.

- **300 Query error.** This shows that a query error has occurred. No more specific information is available.
- **410 Query INTERRUPTED.** A condition occurred that interrupted the transmission of the response to a query (for example, a query followed by a DAB or a GET before the response was completely sent).
- **420 Query UNTERMINATED.** A condition occurred that interrupted the reception of a query (for example, the instrument was addressed to talk and an incomplete program message was received).
- **430 Query DEADLOCKED.** A condition causing a deadlocked query has occurred (for example, both the input and the output buffer are full and the device cannot continue).
- **440 Query UNTERMINATED after indefinite response.** Two queries were received in the same message. The error occurs on the second query if the first requests an indefinite response, and was already executed.

Error Messages

This information is subject to change without notice.
© Keysight Technologies 2002 - 2015
Edition 3, April 2015



08169-90A01



www.keysight.com