

## Errata

**Title & Document Type:** 41951A Impedance Test Kit Operation Note

**Manual Part Number:** 41951-90000

**Revision Date:** February 1990

---

### HP References in this Manual

This manual may contain references to HP or Hewlett-Packard. Please note that Hewlett-Packard's former test and measurement, semiconductor products and chemical analysis businesses are now part of Agilent Technologies. We have made no changes to this manual copy. The HP XXXX referred to in this document is now the Agilent XXXX. For example, model number HP8648A is now model number Agilent 8648A.

### About this Manual

We've added this manual to the Agilent website in an effort to help you support your product. This manual provides the best information we could find. It may be incomplete or contain dated information, and the scan quality may not be ideal. If we find a better copy in the future, we will add it to the Agilent website.

### Support for Your Product

Agilent no longer sells or supports this product. You will find any other available product information on the Agilent Test & Measurement website:

[www.tm.agilent.com](http://www.tm.agilent.com)

Search for the model number of this product, and the resulting product page will guide you to any available information. Our service centers may be able to perform calibration if no repair parts are needed, but no other support from Agilent is available.



OPERATION NOTE

**MODEL 41951A**  
**IMPEDANCE TEST KIT**  
**for HP 4195A**

**SERIAL NUMBERS**

This operation note applies directly to 41951As with 2746J- prefixed serial numbers.

© COPYRIGHT: YOKOGAWA-HEWLETT-PACKARD, LTD. 1987  
9-1, TAKAKURA-CHO, HACHIOJI-SHI, TOKYO, JAPAN

Manual Part No. 41951-90000  
Microfiche Part No. 41951-90050

Printed: February 1990

# TABLE OF CONTENTS

| Section                       | Title                                  | Page |
|-------------------------------|--|------|
| <i>1. GENERAL INFORMATION</i> |  |      |
| 1-1.                          | INTRODUCTION                           | 1-1  |
| 1-2.                          | DESCRIPTION                            | 1-1  |
| 1-3.                          | SPECIFICATIONS                         | 1-1  |
| 1-4.                          | SAFETY CONSIDERATIONS                  | 1-1  |
| 1-5.                          | UNITS COVERED BY THIS MANUAL           | 1-2  |
| 1-6.                          | CONTENTS                               | 1-3  |
| 1-7.                          | ACCESSORIES AVAILABLE                  | 1-3  |
| <i>2. INSTALLATION</i>        |  |      |
| 2-1.                          | INTRODUCTION                           | 2-1  |
| 2-2.                          | INITIAL INSPECTION                     | 2-1  |
| 2-3.                          | INTERCONNECTIONS                       | 2-1  |
| 2-4.                          | STORAGE ENVIRONMENT                    | 2-2  |
| 2-5.                          | PACKING                                | 2-2  |
| <i>3. OPERATION</i>           |  |      |
| 3-1.                          | INTRODUCTION                           | 3-1  |
| 3-2.                          | BLOCK DIAGRAM                          | 3-1  |
| 3-3.                          | APC-7 CONNECTOR                        | 3-1  |
| 3-4.                          | CONNECTING TEST FIXTURE                | 3-2  |
| 3-5.                          | MEASUREMENT CALIBRATION CONSIDERATION  | 3-2  |
| 3-5-1.                        | One Port Full Calibration              | 3-2  |
| 3-5-2.                        | Port Extension                         | 3-3  |
| 3-5-3.                        | Offset Compensation                    | 3-3  |
| 3-6.                          | TEST SIGNAL LEVEL AND OUTPUT IMPEDANCE | 3-4  |
| 3-7.                          | DC BIAS                                | 3-5  |
| 3-7-1.                        | Internal DC Bias                       | 3-5  |
| 3-7-2.                        | External DC Bias                       | 3-5  |
| <i>4. VERIFICATION TEST</i>   |  |      |
| 4-1.                          | INTRODUCTION                           | 4-1  |
| 4-2.                          | EQUIPMENT REQUIRED                     | 4-1  |
| 4-3.                          | CALIBRATION CYCLE                      | 4-1  |
| 4-4.                          | DC PATH CHECK                          | 4-2  |
| 4-5.                          | RF PATH CHECK                          | 4-3  |
| <i>5. MANUAL CHANGES</i>      |  |      |
| 5-1.                          | INTRODUCTION                           | 5-1  |
| 5-2.                          | MANUAL CHANGES                         | 5-1  |
| <i>6. SERVICE</i>             |  |      |
| 6-1.                          | INTRODUCTION                           | 6-1  |
| 6-2.                          | SCHEMATICS AND REPLACEABLE PARTS       | 6-1  |

## SECTION 1

## GENERAL INFORMATION

**1-1. INTRODUCTION**

This operation note provides the information necessary to use the HP 41951A Impedance Test Kit with the HP 4195A Network/Spectrum Analyzer. Refer to the 4195A's Operation Manual for specific 4195A operating procedures.

**1-2. DESCRIPTION**

The 41951A Impedance Test Kit is an accessory for the 4195A. Figure 1-1 shows the contents of the HP 41951A.

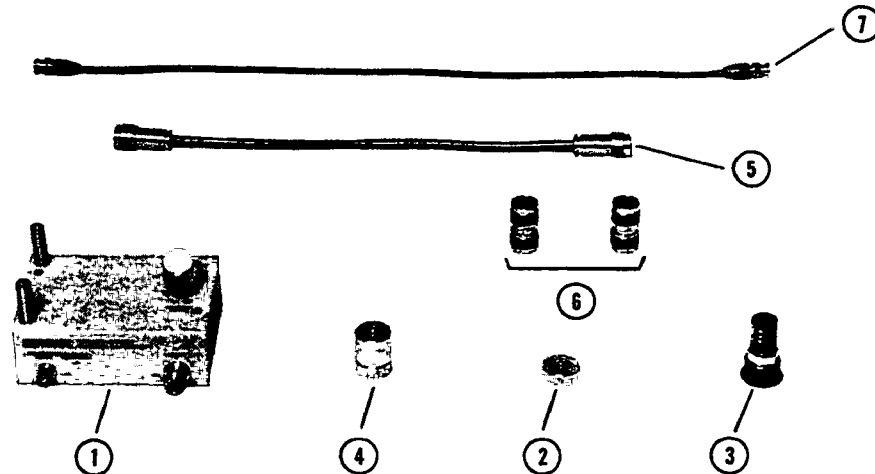

Figure 1-1. Contents of HP 41951A

**1-3. SPECIFICATIONS**

The specifications for the 41951A Impedance Test Kit is listed in Table 1-1. The specifications are performance standards or limits. The 41951A meets all of the specifications listed in Table 1-1 when shipped from the factory.

**1-4. SAFETY CONSIDERATIONS**

The 41951A Impedance Test Kit conform to the safety requirements for IEC 348, and CSA 556B instruments, and is shipped from the factory in a safe condition. This operation note contains information, **CAUTIONS**, and **WARNINGS** which must be followed by the user to ensure safe operation.

## 1-5. UNITS COVERED BY THIS OPERATION NOTE

Hewlett-Packard uses a two-part, nine character serial number which is stamped on the serial number plate ( see Figure 1-2 ) attached to the inside of the carrying case. The first four digits and a letter are the prefix and the last five digits are the suffix of the serial number. The letter in the serial number identifies the country where the instrument was manufactured. The prefix is same for all identical instruments, it changes only when a change is made to the instrument. The suffix, however, is assigned sequentially and is different for each instrument. This operation note applies to instruments with serial number prefixes listed under **Serial Numbers** on the title page.



Figure 1-2. Serial Number Plate

Units manufactured after this operation note was printed may have a serial number prefix which is not listed on the title page. An unlisted serial number prefix indicates that the instrument may be different from those described in this operation note. Operation notes for new instruments may be accompanied by a yellow Manual Changes supplement page, or have a different part number. This supplement contains "Change Information" explaining how to adapt this operation note to newer instruments.

In addition to change information, the supplement may contain information for correcting errors ( Errata ) in previous operation notes. To keep this operation note as current and accurate as possible, Hewlett-Packard recommends that you periodically request the latest Manual Change supplements. The supplement for this operation note is identified by the **Print Date** and **Part Number**, both of which appear on the operation note's title page.

For information concerning the serial number prefixes not listed on the title page or in the Manual Change supplements, contact your nearest Hewlett-Packard Sales office.

**1-6. CONTENTS**

Table 1-2 lists the contents, and includes **No.** which are the same as the designation in Figure 1-1, **Description**, **Qty.** ( Quantity ), and **HP part number**.

Table 1-2. Contents

| No. | Description                      | Qty. | HP Part Number              |
|-----|----------------------------------|------|-----------------------------|
| 1   | Impedance Test Adapter           | 1    | PN 41951-61001              |
| 2   | 0 $\Omega$ Calibration Standard  | 1    | PN 04191-85300              |
| 3   | 50 $\Omega$ Calibration Standard | 1    | PN 04191-85301              |
| 4   | 0S Calibration Standard          | 1    | PN 04191-85302              |
| 5   | N(m)-N(m) Cable                  | 1    | PN 41951-61602              |
| 6   | N(m)-N(m) Adapter                | 2    | PN 1250-0778                |
| 7   | BNC(m)-BNC(m) Cable              | 1    | PN 8120-1839                |
|     | Carrying case                    | 1    | PN 41951-60001 <sup>1</sup> |

**Note** <sup>1</sup>: The serial number plate is not included in the carrying case.

**1-7. AVAILABLE ACCESSORIES**

For making certain types of measurements and for convenience in connecting samples, five accessories are available. Each is designed to meet the various measurement requirements of a variety of test devices. All accessories are developed with careful consideration to accuracy, reliability, and ease of use. A brief description and a photo of each available accessory are given in Table 1-3.

Table 1-1. Specifications ( 1 of 2 )

**41951A Specifications**

|                                |   |
|--------------------------------|---|
| <b>Usable Frequency Range:</b> | 100 kHz to 500 MHz                                      |
| <b>DC Bias Range:</b>          | $\pm 40$ V, $\pm 0.5$ A                                 |
| <b>UNKNOWN Port:</b>           | APC-7 Connector   |
| <b>Weight:</b>                 | Approx. 2.7 kg<br>Approx. 0.55 kg ( Test Adapter only ) |
| <b>Operation Environment:</b>  | 0°C to 55°C<br>$\leq 95\%$ RH at 40°C                   |
| <b>Storage Environment:</b>    | -40°C to 70°C   |

The following specifications apply to the 4195A when used with the 41951A.

|   |   |
|---|---|
| <b>Measurement Parameter:</b>           | $ Z $ , $ Y $ , $\theta$ , R, X, G, B, L, C, D, $Q(=1/D)$             |
| <b>Test Frequency Range:</b>            | 100 kHz to 500 MHz  |
| <b>Signal Level at DUT ( nominal ):</b> | -62 dBm to +3 dBm at 50 $\Omega$ load                                 |
|   | Note: Signal level ( at DUT ) is 12 dB lower than 4195A output level. |
| <b>Output Impedance:</b>                | Nominal 50 $\Omega$   |
| <b>DC Bias (supplied from 4195A):</b>   |   |
| Voltage Range                           | -40 V to 40 V   |
| Resolution                              | 10 mV   |
| Accuracy                                | $\pm ( 0.12\% + 12 \text{ mV } )$ at 23°C $\pm 5^\circ\text{C}$       |
| Maximum Current                         | $\pm 20$ mA   |

Table 1-3. Specifications ( 2 of 2 )

**Measurement Range and Highest Resolution:**

| Parameter | Range                          | Resolution    |
|-----------|--------------------------------|---------------|
| Z , R, X  | 30 m $\Omega$ to 30 k $\Omega$ | 10 m $\Omega$ |
| Y , G, B  | 30 $\mu$ S to 30 S             | 10 $\mu$ S    |
| $\theta$  | -180° to 180°                  | 0.01°         |
| L         | 10 pH to 30 mH                 | 10 pH         |
| C         | 10 fF to 30 $\mu$ F            | 10 fF         |
| D         | 0.001 to 10                    | 0.0001        |
| Q         | 0.1 to 1000                    | 0.01          |

**Measurement Accuracy ( Supplemental Performance Characteristics ):**

Measurement accuracy is specified at the connecting surface of the APC-7 connector, under the following conditions.

- 1) Warm up Time: >30 minutes
- 2) Ambient Temperature: 23°C  $\pm$ 5°C  
at the same temperature at which  
Calibration was performed
- 3) Output Signal Level: 15 dB greater than the Input Range of  
reference port ( the value indicated by  
' RANGE R=' on the 4195A's display )
- 4) Signal Level at DUT: -20 to +3 dBm
- 5) Correction: ON

Figure 1-3 shows the impedance measurement accuracy of HP 4195A when used with the 41951A.



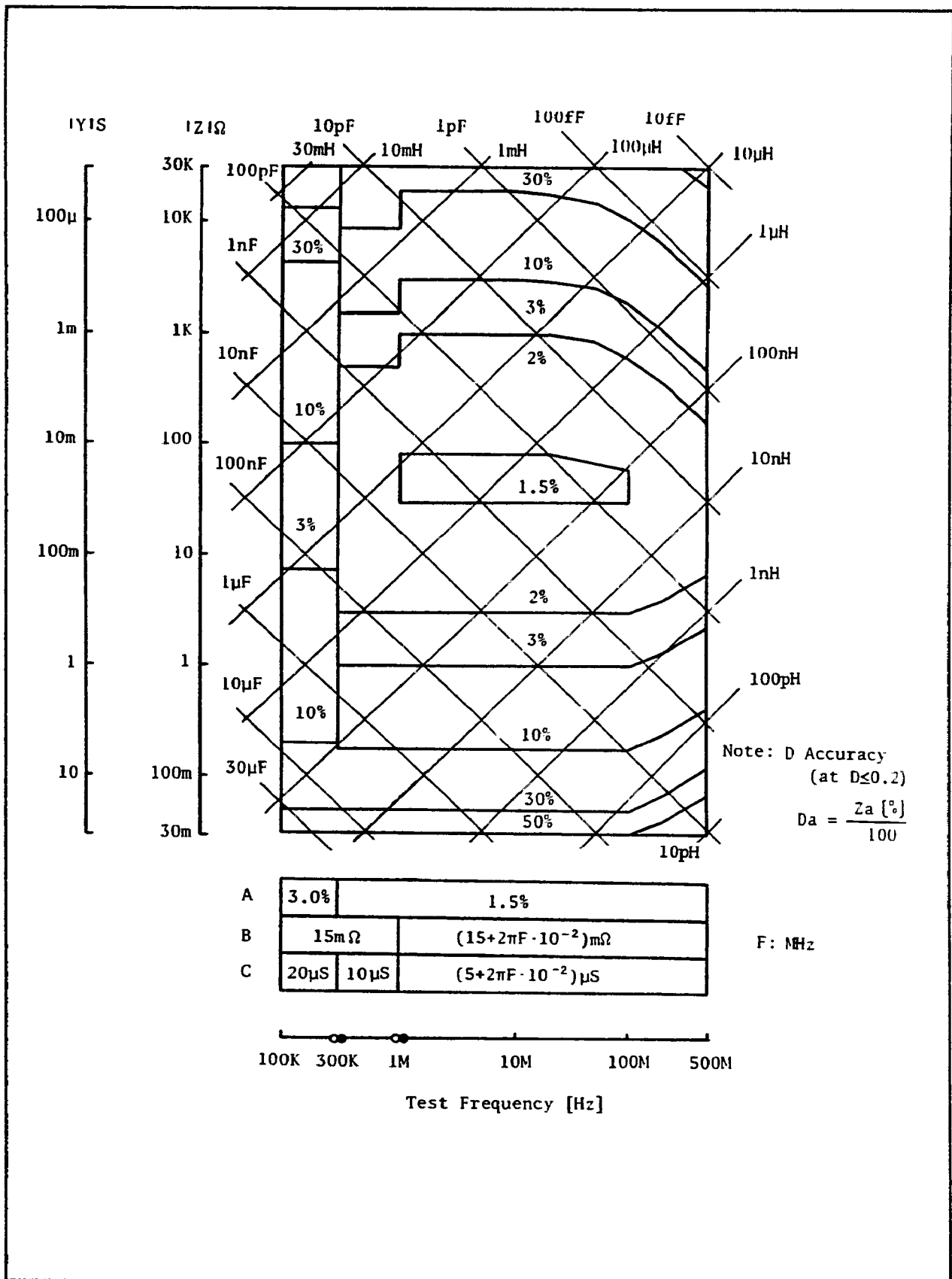
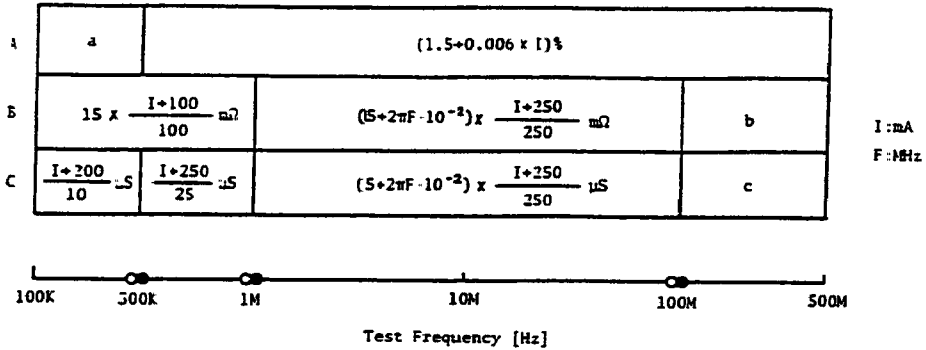

Figure 1-3. Impedance Measurement Accuracy ( 1 of 4 )

- Note: 1. The above data applies to the averaged measurement data ( applies when the VIDEO FILTER is on ).
2. When the DC bias is used, use the following value of A, B, and C in place of the above value, to calculate the measurement accuracy.



$$a: (3.0+0.006 \times I)\%$$

$$b: (15+2\pi F \cdot 10^{-2}) \times \frac{I+100}{100} \text{ m}\Omega$$

$$c: (5+2\pi F \cdot 10^{-2}) \times \frac{I+100}{100} \text{ }\mu\text{S}$$

**|Z| -  $\theta$  Accuracy:**

|Z| accuracy                       $Z_a = A+(B/|Z_m|+C \times |Z_m|) \times 100 (\%)$

$\theta$  accuracy                         $\theta_a = \sin^{-1}(Z_a/100)$

Where  $|Z_m|$  is  $|Z|$  measured. A, B and C are obtained from the graph above.

**|Y| -  $\theta$  Accuracy:**

|Y| accuracy                       $Y_a = A+(B \times |Y_m|+C/|Y_m|) \times 100 (\%)$

$\theta$  accuracy                         $\theta_a = \sin^{-1}(Y_a/100)$

Where  $|Y_m|$  is  $|Y|$  measured. A, B and C are obtained from the graph above.

Figure 1-3. Impedance Measurement Accuracy ( 2 of 4 )

**R, X Accuracy ( depends on D ):**

|    | $D \leq 0.2$                                | $0.2 < D \leq 5$                  | $5 < D$                                     |
|----|---|-----------------------------------|---|
| Ra | $\pm X_m \cdot \frac{Z_a(X)}{100} (\Omega)$ | $\frac{Z_a(R)}{\cos \theta} (\%)$ | $Z_a(R) (\%)$                               |
| Xa | $Z_a(X) (\%)$                               | $\frac{Z_a(X)}{\sin \theta} (\%)$ | $\pm R_m \cdot \frac{Z_a(R)}{100} (\Omega)$ |

D can be calculated as  $R/X$ ,  
 $R/(2 \times \pi \times f \times L_s)$  or  $R \times 2 \times \pi \times f \times C_s$

$\theta$  can be calculated as  $\tan^{-1}(X/R)$ ,  
 $\tan^{-1}(2 \times \pi \times f \times L_s/R)$  or  
 $\tan^{-1}(1/(R \times 2 \times \pi \times f \times C_s))$

$Z_a(R) = A + (B / |R_m| + C \times |R_m|) \times 100 (\%)$   
 $Z_a(X) = A + (B / |X_m| + C \times |X_m|) \times 100 (\%)$

$R_m$  and  $X_m$  are the measured R and X, respectively. A, B and C are obtained from the preceding graph.

**G, B Accuracy ( depends on D ):**

|    | $D \leq 0.2$                           | $0.2 < D \leq 5$                  | $5 < D$                                |
|----|--|-----------------------------------|--|
| Ga | $\pm B_m \cdot \frac{Y_a(B)}{100} (S)$ | $\frac{Y_a(G)}{\cos \theta} (\%)$ | $Y_a(G)$                               |
| Ba | $Y_a(B) (\%)$                          | $\frac{Y_a(B)}{\sin \theta} (\%)$ | $\pm G_m \cdot \frac{Y_a(G)}{100} (S)$ |

D can be calculated as  $G/B$ ,  
 $G/(2 \times \pi \times f \times C_p)$  or  $G \times 2 \times \pi \times f \times L_p$

$\theta$  can be calculated as  $\tan^{-1}(B/G)$ ,  
 $\tan^{-1}(2 \times \pi \times f \times C_p/G)$  or  
 $\tan^{-1}(1/(G \times 2 \times \pi \times f \times L_p))$

$Y_a(G) = A + (B \times |G_m| + C / |G_m|) \times 100 (\%)$   
 $Y_a(B) = A + (B \times |B_m| + C / |B_m|) \times 100 (\%)$

$G_m$  and  $B_m$  are measured G and B, respectively. A, B and C are obtained from the preceding graph.

Figure 1-3. Impedance Measurement Accuracy ( 3 of 4 )

**D Accuracy:**

|    |              |                            |
|----|--------------|----------------------------|
|    | $D \leq 0.2$ | $0.2 < D$                  |
| Da | $Z_a/100$    | $(Z_a/100) \times (1+D^2)$ |

Where  $Z_a$  is  $|Z|$  accuracy

**L Accuracy ( depends on D ):**

|    |              |                   |
|----|--------------|-------------------|
|    | $D \leq 0.2$ | $0.2 < D$         |
| La | La           | $La \times (1+D)$ |

Where

$$La = A + (B/|Z| + C \times |Z|) \times 100 (\%)$$

Where  $|Z| = 2 \times \pi \times f \times L_m$ ,  $f$  is frequency in Hz and  $L_m$  is measured L. A, B and C are obtained from the preceding graph.

**C Accuracy ( depends on D ):**

|    |              |                   |
|----|--------------|-------------------|
|    | $D \leq 0.2$ | $0.2 < D$         |
| Ca | Ca           | $Ca \times (1+D)$ |

Where

$$Ca = A + (B/|Z_c| + C \times |Z_c|) \times 100 (\%)$$

Where  $|Z_c| = 1/2 \times \pi \times f \times C_m$ ,  $f$  is frequency in Hz and  $C_m$  is the measured C. A, B and C are obtained from the preceding graph.

Figure 1-3. Impedance Measurement Accuracy ( 4 of 4 )

Table 1-3. Available Accessories ( 1 of 2 )

| Model  | Description  |                 |         |                 |  |   |             |   |      |   |       |  |             |   |       |   |       |
|--|--|-----------------|---------|-----------------|--|---|-------------|---|------|---|-------|--|-------------|---|-------|---|-------|
| <p data-bbox="332 352 477 380">HP 16091A</p>      | <p data-bbox="740 352 943 380">Coaxial Fixtures</p> <p data-bbox="740 411 1417 562">Test Fixtures ( coaxial termination type ) for holding a piece of sample holders accommodate a cylindrical sample in their respective inner chambers. Two kinds of fixtures fit samples dimensions given below.</p> <table border="1" data-bbox="802 583 1343 810"> <thead> <tr> <th>Sample</th> <th>Fixture</th> <th colspan="2">Max. dimensions</th> </tr> </thead> <tbody> <tr> <td rowspan="2">  </td> <td rowspan="2">04191-85302</td> <td>d</td> <td>7 mm</td> </tr> <tr> <td>ℓ</td> <td>20 mm</td> </tr> <tr> <td rowspan="2"></td> <td rowspan="2">16091-60012</td> <td>d</td> <td>10 mm</td> </tr> <tr> <td>ℓ</td> <td>20 mm</td> </tr> </tbody> </table> <p data-bbox="740 842 1290 932">Usable frequency range: DC to 1000 MHz.<br/>Electrical length: 1.87 cm ( typical ).<br/>Maximum applied DC bias voltage: ±40 V.</p> <p data-bbox="740 968 1422 1119">Note: The 16091A fixture of 7 mm inner diameter ( P/N 04191-85302 ) is actually the same as the 0S standard termination. Thus, this fixture is not supplied with the 16091A fixture set since the furnished 0S termination can be used.</p> | Sample          | Fixture | Max. dimensions |  |  | 04191-85302 | d | 7 mm | ℓ | 20 mm |  | 16091-60012 | d | 10 mm | ℓ | 20 mm |
| Sample   | Fixture  | Max. dimensions |         |                 |  |   |             |   |      |   |       |  |             |   |       |   |       |
|   | 04191-85302  | d               | 7 mm    |                 |  |   |             |   |      |   |       |  |             |   |       |   |       |
|  |  | ℓ               | 20 mm   |                 |  |   |             |   |      |   |       |  |             |   |       |   |       |
|  | 16091-60012  | d               | 10 mm   |                 |  |   |             |   |      |   |       |  |             |   |       |   |       |
|  |  | ℓ               | 20 mm   |                 |  |   |             |   |      |   |       |  |             |   |       |   |       |
| <p data-bbox="340 1188 485 1215">HP 16092A</p>  | <p data-bbox="745 1188 987 1215">Spring Clip Fixture</p> <p data-bbox="745 1247 1427 1371">Test fixture for connecting axial and radial lead components, and leadless chip components. The spring clip contacts can be adjusted to the dimensions given below.</p>  <p data-bbox="750 1713 1433 1808">A slide gauge provides direct read-out of the length of the test sample. Maximum applicable DC bias is ±150 V/±0.5 A.</p>  |                 |         |                 |  |   |             |   |      |   |       |  |             |   |       |   |       |

Table 1-3. Accessories Available ( 2 of 2 )

|  |  |
|--|--|
| <p style="text-align: center;">HP 16093A</p>    | <p><b>Binding Post Fixture</b></p> <p>A test fixture used when measuring miniature axial and radial lead components. Two binding post terminals at intervals of 7 mm on the terminal deck ensure optimum contact of terminals and the test sample leads.</p>  <p>The maximum DC bias that can be applied is <math>\pm 40\text{ V}/\pm 0.5\text{ A}</math>.</p>  |
| <p style="text-align: center;">HP 16093B</p>   | <p><b>Binding Post Fixture</b></p> <p>A Test fixture for connecting common axial and radial lead components. Three binding post terminals are located on the terminal deck as shown below.</p>  <p>The maximum DC bias that can be applied is <math>\pm 40\text{ V}/\pm 0.5\text{ A}</math>.</p>  |
| <p style="text-align: center;">HP 16094A</p>  | <p><b>Probe Fixture</b></p> <p>Test Fixture for measurement of circuit impedances and components mounted on circuit assemblies. The probe adapter unit can be attached at the tip of an extension line connected to the test port. The probe connector fits APC-7 connector of a coaxial test cable or a flexible air line. Probe needle interval is variable from 1 mm to 15 mm. Electrical length compensation in the instrument must be adjusted for probe cable length.</p> <p>Usable frequency range: DC to 125 MHz.<br/>         Electrical length: 2.32 cm ( typical ).<br/>         Maximum applied DC bias voltage: <math>\pm 40\text{ V}</math>.</p> |

*SECTION 2*  
*INSTALLATION*

**2-1. INTRODUCTION**

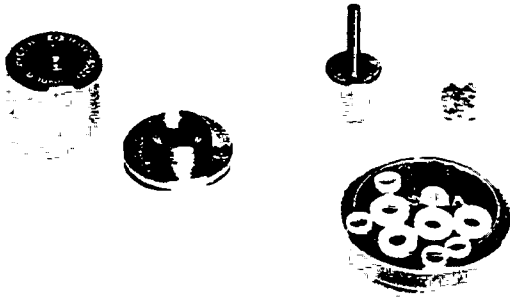
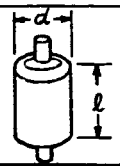
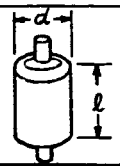
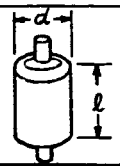
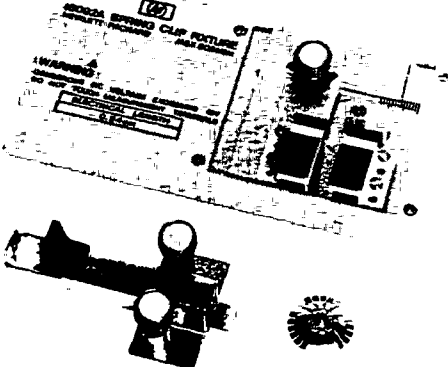
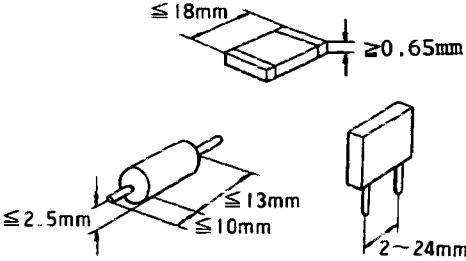
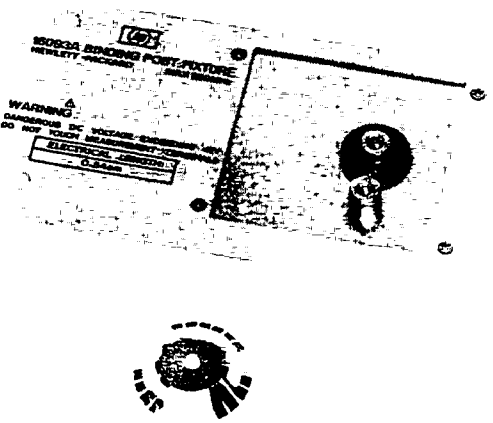
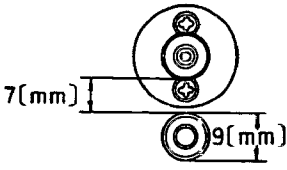
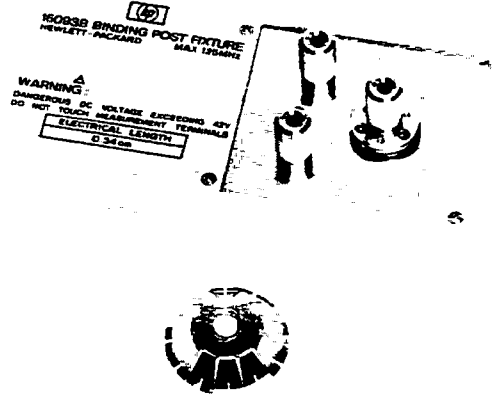
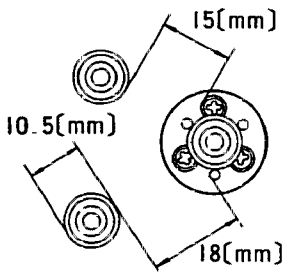
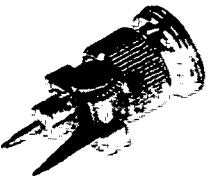
This section provides installation instructions for the HP 41951A Impedance Test Kit. It also includes information on the initial inspection, damage claims, preparation for using the 41951A, packaging, storage, and shipment.

**2-2. INITIAL INSPECTION**

The 41951A Impedance Test Kit meet all of the specifications listed in Table 1-1. Upon receipt, inspect the shipping container for damage. If the shipping container or the cushioning material has been damaged, keep the container and packing material until the contents have been checked for completeness and the test kit has been checked out mechanically and electrically. The contents should be as shown in Figure 1-1. The procedures for checking the general electrical operation are given in Section 4.

If anything is missing, damaged ( scratches, dents, broken connectors, etc. ), or if performance does not meet the verification test limits, notify the nearest HP Sales office ( see the list at the back of this operation note ). The HP Sales Office will immediately arrange for repair or replacement without waiting for a claim settlement.

**2-3. INTERCONNECTIONS**

The interconnection between the 41951A and the 4195A, is achieved by connecting the **Impedance Test Adapter** to the 4195A's **Channel 1** or **2**, using the furnished **Adapters** and **Cables**.

1. Connect two female N-type connectors; **INPUT S** and **OUTPUT R**, to the 4195A's **OUTPUT S1** ( or **S2** ) and **INPUT R1** ( or **R2** ) connectors, using two furnished **N(m)-N(m)** Adapters, respectively.

**NOTE**

When connecting the **INPUT S** and **OUTPUT R** connectors, do not try to tighten one connector completely, alternately tighten each connector, little by little, until both connectors are tight.

2. Connect the **OUTPUT T** connector to the 4195A's **INPUT T1** ( or **T2** ) connector, using the furnished **N(m)-N(m)** Cable.
3. If the DC bias supplied from the 4195A is used, connect the **DC SOURCE INPUT** connector to the 4195A's **DC SOURCE OUTPUT** connector using the furnished **BNC(m)-BNC(m)** Cable.

**NOTE**

If the DC bias supplied from an external DC power supply is used, connect the **DC SOURCE INPUT** connector to the power supply's output terminal. The outer conductor of the **DC SOURCE INPUT** connector is grounded.

**2-4. STORAGE ENVIRONMENT**

The 41951A may be stored or shipped under the following environmental conditions.

Temperature      -40°C to 70°C

The unit must be protected from temperature extremes which can cause condensation.

**2-5. PACKING****Original Packing.**

Containers and packing material identical to those used in factory packaging are available from Hewlett-Packard. If the unit is being returned to Hewlett-Packard for servicing, attach a tag indicating the type of service required, return address, model number and full serial number.

**Other Packing.**

The following general instructions should be used for repacking with commercially available materials:

- a. Wrap the unit in heavy paper or plastic. If shipping to a Hewlett-Packard Sales Office or Service Center, attach a tag indicating the type of service required, return address, model number and the full serial number.
- b. Use a strong shipping container. A double-walled carton made of 350 pound test material is adequate.
- c. Use enough shock absorbing material ( a 3 to 4 inch layer ) around all sides of the unit to provide a firm cushion and to prevent the unit from moving inside the container.
- d. Seal the shipping container securely.
- e. Mark the shipping container **FRAGILE** to ensure careful handling.
- f. In any correspondence, refer to unit by its model number and the full serial number.

**NOTE**

If you ever need to return the 41951A for servicing, HP recommends that you return your 4195A also so that system performance can be verified after repairs are made.



### SECTION 3

### OPERATION

#### 3-1. INTRODUCTION

This section provides the information necessary to use the 41951A. **WARNINGS, CAUTIONS,** and **NOTES** are given throughout, and they should be followed to insure operator safety and serviceability of the unit.

#### NOTE

For detailed information on 4195A operation, refer to the 4195A's Operation Manual.

#### 3-2. BLOCK DIAGRAM

The Impedance Test Adapter's block diagram is shown in Figure 3-1. The number included in Figure 3-1, indicates the insertion loss of the Impedance Test Adapter when the 41951A is connected to the HP 4195A, and the  $50\ \Omega$  load is connected to the measurement terminal (APC-7 connector) of the Impedance Test Adapter. The output signal to the **OUTPUT R** connector is approximately 18 dB lower than the input signal to the **INPUT S** connector, and the output signal to the DUT is approximately 12 dB lower than the input signal (the voltage applied to DUT is about a quarter of the voltage supplied from the 4195A).

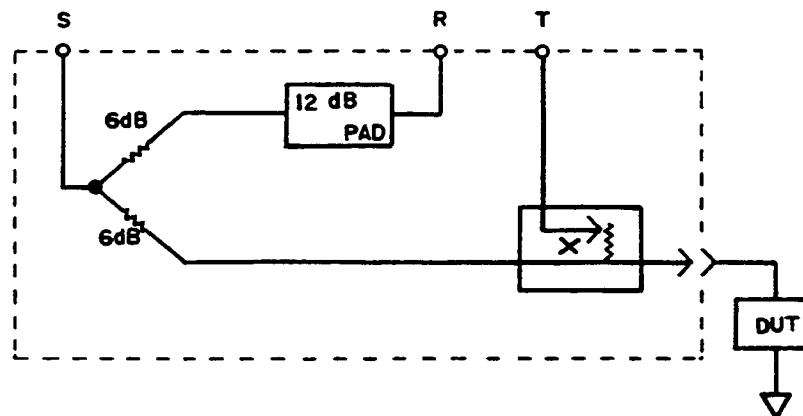

Figure 3-1. Impedance Test Adapter's Block Diagram

#### 3-3. APC-7 CONNECTOR

The 41951A's measurement terminal is an APC-7 connector. This connector provides the capability for connecting and installing an accessory test fixture matched to the 41951A, or a user-built test fixture. The APC-7 connector test port, a two-terminal configuration, has a characteristic impedance of  $50\ \Omega$  which is equal to the base impedance in reflection coefficient measurements. This base impedance represents the reference in the normalized impedance calculations for multiple parameter derivations.

The connecting surface of the APC-7 connector, the calibration standards, and the test fixtures must be kept free of spots, dust, oil and adhesives which will cause poor contact. To maintain clean contact surfaces, it is recommended that the operator perform periodic cleaning as necessary. Use a lint-free cloth and, if a cleaning fluid is needed, use isopropyl alcohol.

**CAUTION**

**Do not use aromatic or chlorinated hydrocarbons, esters, ethers, terpenes, higher alcohols, ketones, or ether-alcohols such as benzene, toluene, turpentine, dioxane, gasoline, cellulose acetate, or carbon tetrachloride. Keep exposure of the connector parts to both the cleaning fluid and its vapors as brief as possible.**

### 3-4. CONNECTING TEST FIXTURE

The following five test fixture are available for the impedance measurement using the 41951A with the 4195A ( see Table 1-3 ).

|             |                      |
|-------------|----------------------|
| HP 16091A   | Coaxial Fixture      |
| HP 16092A   | Spring Clip Fixture  |
| HP 16093A/B | Binding Post Fixture |
| HP 16094A   | Probe Fixture        |

The test fixture is installed by connecting to the APC-7 connector on 41951A's Impedance Test Adapter. For the details, refer to the test fixtures' operation notes.

### 3-5. MEASUREMENT CALIBRATION CONSIDERATIONS

The 4195A provides the one port full calibration, port extension, and offset compensation capabilities for accurate impedance measurement. One port full calibration corrects for the measurement errors caused by the measurement instrument and Impedance Test Adapter. Port extension compensates for phase shifts in extension cables that connects the calibration plane and the DUT. Offset compensates for the measurement errors caused by the residual impedance and stray admittance, between the calibration plane and DUT. For details of the measurement calibration, refer to the 4195A's Operation Manual.

At the measurement which can perform the offset compensation at the measurement terminal, the one port full calibration and offset compensation should be performed. If the measurement terminal is extended using 50  $\Omega$  low loss cable ( as the air line ), or the offset compensation cannot be performed at the measurement terminal, the port extension should be performed instead of the offset compensation. If needed, all measurement calibration procedures can be performed under actual measurement conditions.

#### 3-5-1. ONE PORT FULL CALIBRATION

The one port full calibration compensates for the measurement errors due to the frequency of the Impedance Test Adapter. This calibration is required to extend the calibration plane to the connecting surface of the APC-7 connector of the Impedance Test Adapter or the extended measurement terminal ( see Figure 3-2 ). If the measurement terminal is extended by a cable with APC-7 connectors, the one port full calibration should be performed at the

extended measurement terminal. To perform one port full calibration, three calibration standards; 0S, 0  $\Omega$ , 50  $\Omega$ , are required. For the procedure of the one port full calibration, refer to the 4195A's Operation Manual.

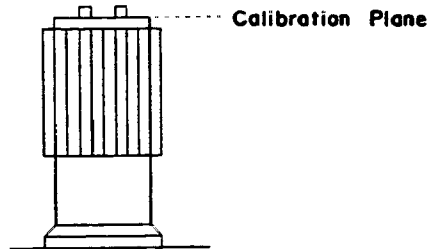

Figure 3-2. 41951A's Calibration Plane

The reference values of the furnished calibration standards are listed in Table 3-1.

Table 3-1. Reference Values for Calibration Standards

| Standard              | Reference Value                                |
|-----------------------|--|
| 0 S admittance        | 0 S + j $\times$ $\omega$ $\times$ 82 fF       |
| 0 $\Omega$ impedance  | 0 $\Omega$ + j $\times$ $\omega$ $\times$ 0 H  |
| 50 $\Omega$ impedance | 50 $\Omega$ + j $\times$ $\omega$ $\times$ 0 H |

These values are stored in the 4195A's battery back-up memory as the calibration reference values.

#### NOTE

If you extend the calibration plane beyond the connecting surface of the APC-7 connector, and you have accurate standards that can be connected to the end of the extension, calibration will be accurate to the end of the extension. Refer to the 4195A's Operation Manual for the procedure for entering the reference values of your standards.

#### 3-5-2. PORT EXTENSION

The port extension compensates for the phase shift in the extension cable. This capability is effective when the measurement terminal is extended by the 50  $\Omega$  low loss cable as the air line, or when the offset compensation cannot be performed. For procedure of the port extension capability, refer to the 4195A's Operation Manual.

#### 3-5-3. OFFSET COMPENSATION

The 4195A applies three offset compensation; 0S & 0 $\Omega$  offset, 0S offset, and 0 $\Omega$  offset compensation. The 0S & 0 $\Omega$  offset compensates for the residual impedance and stray admittance existing in the test fixture, that is attached on an Impedance Test Adapter. The 0S

offset compensates for the stray admittance, and the  $0\Omega$  offset compensates for the residual impedance.

To perform the offset compensation, select the offset compensation mode by pressing the '  $0S$  OFFSET ', '  $0\Omega$  OFFSET ' or '  $0S\&0\Omega$  OFFSET ' softkey. If the  $0S$  &  $0\Omega$  offset compensation is selected, the '  $0S$  ' and '  $0\Omega$  ' softkeys are displayed on the softkey area. If the  $0S$  offset or  $0\Omega$  offset compensation is selected, one of these softkeys is displayed. To perform the offset compensation, short ( or open ) the measurement terminal on the test fixture, and press the '  $0\Omega$  ( or  $0S$  ) ' softkey and ENTER/EXECUTE key.

**NOTE**

The test fixture must be configured the same as it will be for performing compensation and for making a measurement.

**3-6. TEST SIGNAL LEVEL AND OUTPUT IMPEDANCE**

The test signal level applied to DUT depends on the test signal level applied from the 4195A, the output impedance and insertion loss of the Impedance Test Adapter, and the impedance of DUT. The 41951A's output impedance is approximately  $50\Omega$ .

The equivalent circuit and equation to calculate the test signal level is shown in Figure 3-3.

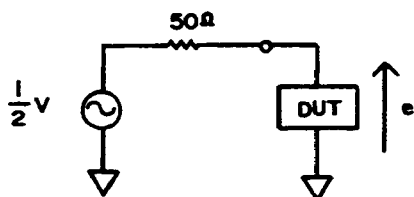

$$e = V \times ZL / \{ 2 \times ( ZL + 50 ) \} [V]$$

Where V: 4195A's output Signal Level [V]  
 ZL: Impedance of DUT [ $\Omega$ ]  
 e: Test Signal Level at DUT

Figure 3-3. Test Signal Level Calculation

The calculation example of the test signal level at DUT is shown in Table 3-2.

Table 3-2. Test Signal Level

| Impedance of DUT | 4195A's Signal Level Setting |        |
|------------------|------------------------------|--------|
|                  | 0dBm                         | 1V     |
| infinite         | 112 mV                       | 0.5 V  |
| 1 k $\Omega$     | 106 mV                       | 0.48 V |
| 100 $\Omega$     | 75 mV                        | 0.33 V |
| 50 $\Omega$      | 56 mV                        | 0.25 V |

### 3-7. DC BIAS

#### 3-7-1. Internal DC Bias

To use the 4195A's internal DC bias capability, connect the furnished BNC cable between the 4195A's **DC SOURCE OUTPUT** connector and the 41951A's **DC SOURCE INPUT** connector.

#### 3-7-2. External DC Bias

External DC bias can be used up to  $\pm 40$  V and  $\pm 500$  mA.

**CAUTION**

**DO NOT SHORT THE TEST PORT WHEN AN EXTERNAL DC BIAS IS APPLIED, OR YOU WILL BLOW THE FUSE IN THE IMPEDANCE TEST ADAPTER.**

**CAUTION**

**DO NOT PERFORM A CALIBRATION MEASUREMENT WHILE A DC BIAS IS APPLIED. THE CALIBRATION STANDARDS MAY BE DAMAGED IF YOU DO.**

*SECTION 4*  
*VERIFICATION TEST*

**4-1. INTRODUCTION**

This section contains the basic operational checkout procedures for the HP 41951A. All tests can be performed without access to the interior of the 41951A. The verification test is typically used for incoming inspection of the 41951A, and to verify that the Impedance Test Adapter is in good order after it has been repaired.

**4-2. EQUIPMENT REQUIRED**

Table 4-1 lists the equipment required to perform the verification test. Equipment that meets or exceeds the critical specifications listed in the table may be used as a substitute for the recommended models. The equipment used for verification testing must be calibrated.

Table 4-1. Recommended Test Equipment

| <b>Equipment</b>   | <b>Critical Specifications</b>   | <b>Recommended Model</b> |
|--------------------|--|--------------------------|
| Network Analyzer   | Frequency: 100 kHz to 500 MHz<br>Impedance: 50 $\Omega$<br>Accuracy: $\pm 0.5$ dB              | HP 4195A                 |
| Digital Multimeter | Resistance Measurement Range:<br>5 to 30 $\Omega$<br>Accuracy: $\pm 1\%$                       | HP 3478A                 |
| Power Splitter     | Frequency: 100 kHz to 500 MHz<br>Input Impedance: 50 $\Omega$<br>Output Impedance: 50 $\Omega$ | HP 11667A                |

**4-3. CALIBRATION CYCLE**

The 41951A requires periodic performance verification. The 41951A ( Impedance Test Adapter ) should be checked out using the verification test at least once a year or more depending on the frequency of use. Preventive maintenance should be performed at least twice a year to keep down-time to a minimum, and to insure optimum operation,

#### 4-4. DC BIAS PATH CHECK

This test checks the resistance of the path between the 41951A's **DC SOURCE INPUT** connector and the APC-7 connector.

#### REQUIRED EQUIPMENT:

|                                 |           |
|---------------------------------|-----------|
| Digital Multimeter              | HP 3478A  |
| APC-7 to N(f) Adapter ( 1 ea. ) | HP 11524A |
| Test Leads                      |           |

#### PROCEDURE:

1. Connect the Test Leads to the Digital Multimeter's high and low terminals.
2. Connect the APC-7 to N(f) Adapter to the Impedance Test Adapter's APC-7 connector.
3. Set the Digital Multimeter to the resistance measurement mode.
4. Connect a tip of the Test Lead connected to the DMM high input to the center conductor of the Impedance Test Adapter's **DC SOURCE INPUT** connector, and the tip of the Test Lead connected to the DMM's low input to the center conductor of the APC-7 to N(f) Adapter connected to the Impedance Test Adapter's APC-7 connector.
5. Check that the Digital Multimeter's reading is less than 10  $\Omega$ .

#### 4-5. RF PATH CHECK

This test checks the RF path of the Impedance Test Adapter.

#### REQUIRED EQUIPMENT:

|                               |              |
|-------------------------------|--------------|
| Network Analyzer              | HP 4195A     |
| Power Splitter                | HP 11667A    |
| N(m)-BNC(f) Adapter ( 4 ea. ) | HP 1250-0780 |
| BNC(m)-BNC(m) Cable ( 2 ea. ) | HP 8120-1838 |

#### NOTE

The N(m)-N(m) Cable ( 2 ea. : HP 11500B ) can be used instead of the N(m)-BNC(f) Adapter ( 4 ea. ) and BNC(m)-BNC(m) Cable ( 2 ea. ).

#### PROCEDURE:

1. Set the Network Analyzer as follows.

|           |                   |                               |
|-----------|-------------------|-------------------------------|
| Source:   | Frequency:        | 100 kHz to 500 MHz, Log sweep |
|           | OSC Level:        | +5 dBm                        |
|           | DC Bias:          | OFF                           |
| Receiver: | RBW:              | 1 kHz                         |
|           | INPUT RANGE R-ch: | 0 dBm                         |
|           | T-ch:             | 0 dBm                         |

2. Connect the Power Splitter to the Network Analyzer, as shown in Figure 4-1 (1).

#### NOTE

Use the N(m) to N(m) Adapter included with the 41951A to connect the Power Splitter's **INPUT** terminal to the Network Analyzer's **SOURCE** terminal,

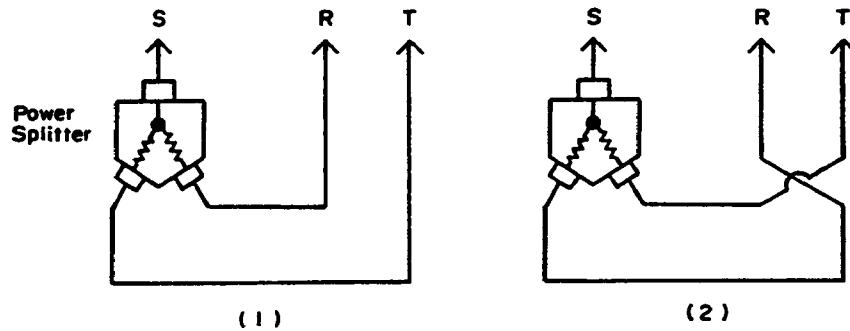

Figure 4-1. Power Splitter Connection



3. Measure the T/R and store the data ( data  $D_1$  ). All measured data in the measurement range, must be stored. This data is used to calculate the compensation data.
4. Swap the cable connection with the Adapter at the Network Analyzer's INPUT port ( do not try to swap the cables at the Power Splitter's OUTPUT ), as shown in Figure 4-1 (2).
5. Measure the T/R and store the data ( data  $D_2$  ).
6. Perform the following calculation, and store the result ( data  $D_3$  ). Data  $D_3$  is used as the compensation data, in the following steps.

$$D_3 = \{ ( \text{data } D_1 ) + ( \text{data } D_2 ) \} / 2$$

7. Connect the Impedance Test Adapter to the Network Analyzer ( refer to paragraph 2-3, INTERCONNECTION ).
8. Connect the OS Calibration Standard ( OPEN ) to the APC-7 connector of the Impedance Test Adapter, and measure the T/R.
9. Compensate the measured data by subtracting data  $D_3$  from the measured data. Confirm that the compensated data is  $0 \pm 3$  dB.
10. Connect the  $0 \Omega$  Calibration Standard ( SHORT ) to the APC-7 connector of the Impedance Test Adapter, and measure the T/R.
11. Compensate the measured data by subtracting data  $D_3$  from the measured data. Confirm that the compensated data is  $0 \pm 3$  dB.
12. Connect the  $50 \Omega$  Calibration Standard ( LOAD ) to the APC-7 connector of the Impedance Test Adapter, and measure the T/R.
13. Compensate the measured data by subtracting data  $D_3$  from the measured data. Confirm that the compensated data is less than -30 dB.

#### NOTE

In steps 9, 11 and 13, the compensation can be performed easily, by using the 4195A's User Math capability. If the compensation data is stored in the 4195A's RA register, the following equation should be entered.

$$\text{DMA} = \text{MA} - \text{RA}$$

For the details of the User Math capability, refer to the 4195A's Operation Manual.

*SECTION 5*  
*MANUAL CHANGES*

**5-1. INTRODUCTION**

This section contains information for adapting this manual to instruments to which its contents do not directly apply. The following paragraphs explain how to adapt this manual to older instruments which have a serial prefix/number lower than that given on the title page.

**5-2. MANUAL CHANGES**

To adapt this manual to your instrument, refer to Table 5-1 and make all of the manual changes listed opposite your instrument's serial number. Perform these changes in the sequence given.

If your instrument serial number is not listed on the title page of this manual or in Table 5-1, it may be documented in a yellow MANUAL CHANGES supplement. For additional information about serial number coverage, refer to UNITS COVERED BY THIS OPERATION NOTE in Section 1.

Table 5-1. Manual Changes by Serial Number

| <b>Serial Prefix or Number</b> | <b>Make Manual Changes</b> |
|--------------------------------|----------------------------|
|                                |                            |

## SECTION 6

### SERVICE

#### 6-1. INTRODUCTION

This section provides the information required to service the HP 41951A Impedance Test Kit. The Schematic Diagram, and the Replaceable Parts List are included.

#### 6-2. SCHEMATICS AND REPLACEABLE PARTS

The HP 41951A consists of the assemblies listed in Table 1-2. Any assembly except for the Impedance Test Adapter, should be replaced by the assembly level, when it is damaged. The part numbers are shown in Figure 1-1, and Table 1-2.

Only mechanical parts, cables, and a fuse listed in Table 6-1 and Table 6-2 are replaceable for the Impedance Test Adapter. If parts which are not listed in Table 6-1 and Table 6-2 is damaged, the Impedance Test Adapter must be replaced with the entire assembly (PN 41951-61001).

Figure 6-1 shows the schematic diagram of the Impedance Test Adapter.

Table 6-1 lists the Impedance Test Adapter's replaceable parts except for those associated with the APC-7 connector mounted on the Impedance Test Adapter's top cover, and shows their location.

Table 6-2 shows an exploded view of the APC-7 connector, and lists the APC-7 connector's replaceable parts. For APC-7 connector's (precision 7 mm connector's) general information, refer to the Microwave Connector Care manual (PN 08510-90064) or application note 326, Principles of Microwave Connector Care (PN 5954-1566).

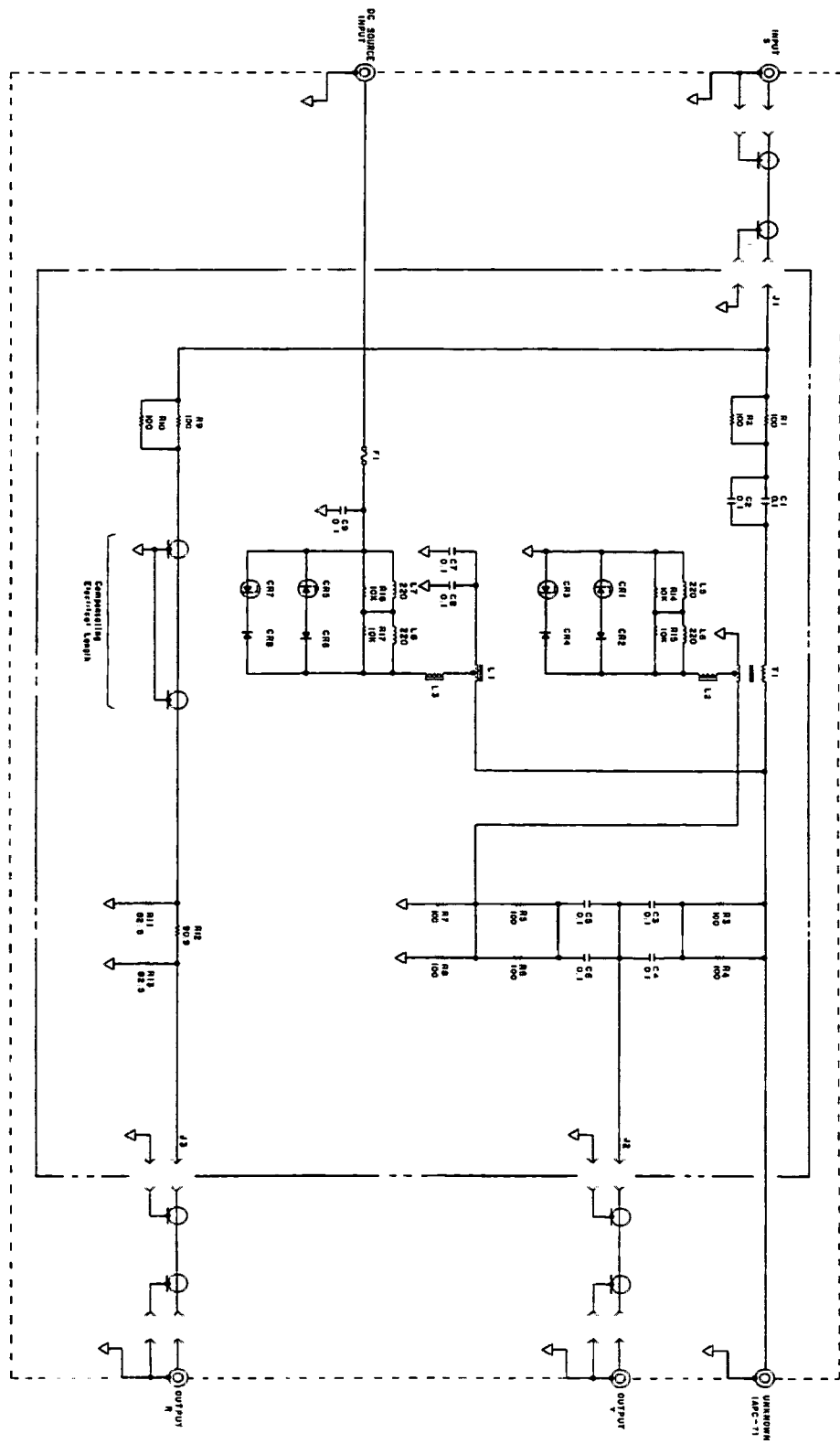
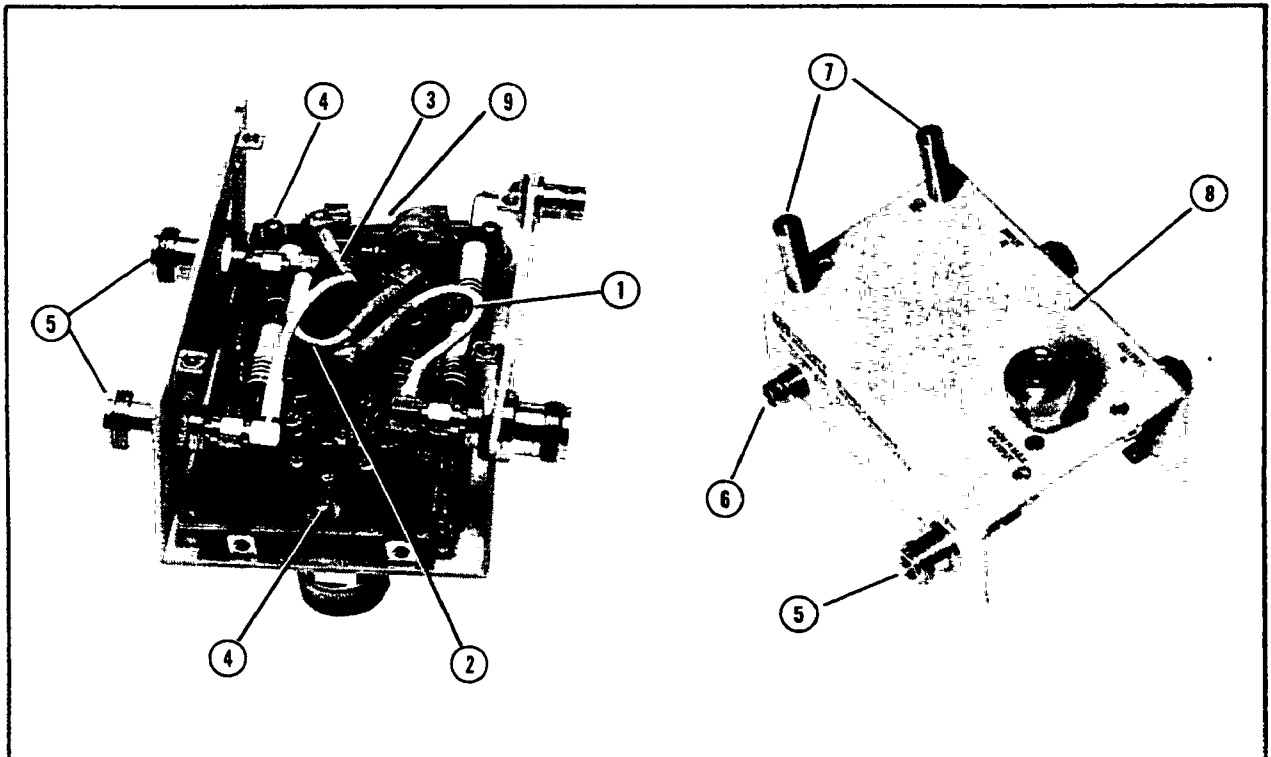

Figure 6-1. Schematic Diagram of the Impedance Test Adapter

Table 6-1. Replaceable Parts List



| Reference Designator | HP Part Number | Qty. | Description                    |
|----------------------|----------------|------|--------------------------------|
| 2                    | 41951-61601    | 1    | Cable Assembly                 |
| 3                    | 41951-61603    | 1    | Cable Assembly                 |
| 4                    | 0515-1550      | 5    | Screw                          |
| 5                    | 1250-1811      | 3    | N(f)-SMA(f) Adapter (with NUT) |
|                      | 2190-0054      | 3    | Washer                         |
| 6                    | 1250-0083      | 1    | Connector-RF BNC               |
|                      | 2190-0016      | 1    | Washer                         |
|                      | 2950-0001      | 1    | Nut                            |
| 7                    | 41951-24001    | 2    | Post                           |
|                      | 2190-0084      | 2    | Washer                         |
|                      | 2950-0006      | 2    | Nut                            |
| 8                    | 41951-04001    | 1    | Top Cover                      |
| 9                    | 2110-0001      | 1    | Fuse 1A 250V                   |
| Not Shown            | 41951-04002    | 1    | Bottom Cover                   |
|                      | 0515-0914      | 8    | Screw                          |
|                      | 6960-0016      | 3    | Plug-Hole                      |

Table 6-2. APC-7 Connector

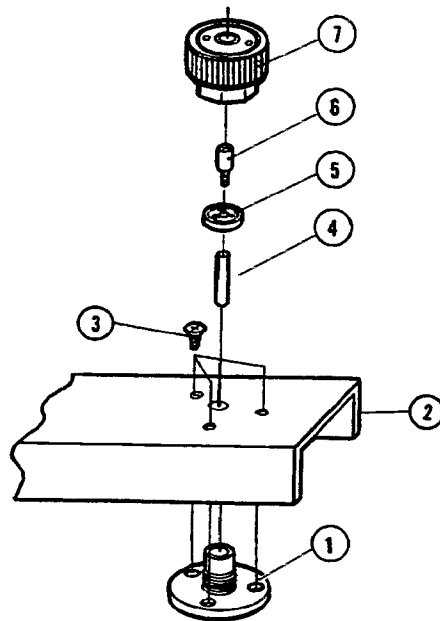

| Reference Designator | HP Part Number         | Qty.   | Description                          |
|----------------------|------------------------|--------|--------------------------------------|
| 1                    | 41951-21001            | 1      | Flange                               |
| 2                    | 41951-04001            | 1      | Top Cover                            |
| 3                    | 0515-0914              | 3      | Screw                                |
| 4                    | Not Replaceable        | 1      | Center Conductor                     |
| 5                    | 5040-0306              | 1      | Insulator                            |
| 6                    | 1250-0816<br>1250-0907 | 1<br>1 | Connector-RF<br>Center Contactor     |
| 7                    | 1250-1466              | 1      | Connector-RF APC-7<br>( with a cap ) |