

Operating Manual
Agilent Technologies
Single Input
Electronic Load Family



Agilent Technologies

CERTIFICATION

Agilent Technologies certifies that this product met its published specifications at time of shipment from the factory. Agilent Technologies further certifies that its calibration measurements are traceable to the United States National Bureau of Standards, to the extent allowed by the Bureau's calibration facility, and to the calibration facilities of other International Standards Organization members.

WARRANTY

This Agilent Technologies hardware product is warranted against defects in material and workmanship for a period of three years from date of delivery. Agilent Technologies software and firmware products, which are designated by Agilent Technologies for use with a hardware product and when properly installed on that hardware product, are warranted not to fail to execute their programming instructions due to defects in material and workmanship for a period of 90 days from date of delivery. During the warranty period Agilent Technologies will, at its option, either repair or replace products which prove to be defective. Agilent Technologies does not warrant that the operation of the software, firmware, or hardware shall be uninterrupted or error free.

For warranty service, with the exception of warranty options, this product must be returned to a service facility designated by Agilent Technologies. Customer shall prepay shipping charges by (and shall pay all duty and taxes) for products returned to Agilent Technologies for warranty service. Except for products returned to Customer from another country, Agilent Technologies shall pay for return of products to Customer.

Warranty services outside the country of initial purchase are included in Agilent Technologies product price, only if Customer pays Agilent Technologies international prices (defined as destination local currency price, or U.S. or Geneva Export price).

If Agilent Technologies is unable, within a reasonable time to repair or replace any product to condition as warranted, the Customer shall be entitled to a refund of the purchase price upon return of the product to Agilent Technologies, Inc.,

LIMITATION OF WARRANTY

The foregoing warranty shall not apply to defects resulting from improper or inadequate maintenance by the Customer, Customer-supplied software or interfacing, unauthorized modification or misuse, operation outside of the environmental specifications for the product, or improper site preparation and maintenance. NO OTHER WARRANTY IS EXPRESSED OR IMPLIED. AGILENT TECHNOLOGIES SPECIFICALLY DISCLAIMS THE IMPLIED WARRANTIES OF MERCHANTABILITY AND FITNESS FOR A PARTICULAR PURPOSE.

EXCLUSIVE REMEDIES

THE REMEDIES PROVIDED HEREIN ARE THE CUSTOMER'S SOLE AND EXCLUSIVE REMEDIES. AGILENT TECHNOLOGIES SHALL NOT BE LIABLE FOR ANY DIRECT, INDIRECT, SPECIAL, INCIDENTAL, OR CONSEQUENTIAL DAMAGES, WHETHER BASED ON CONTRACT, TORT, OR ANY OTHER LEGAL THEORY.

ASSISTANCE

The above statements apply only to the standard product warranty. Warranty options, extended support contracts, product maintenance agreements and customer assistance agreements are also available. Contact your nearest Agilent Technologies Sales and Service office for further information on Agilent Technologies' full line of Support Programs.

SAFETY SUMMARY

The following general safety precautions must be observed during all phases of operation, service, and repair of this instrument. Failure to comply with these precautions or with specific warnings elsewhere in this manual violates safety standards of design, manufacture, and intended use of the instrument. Agilent Technologies assumes no liability for the customer's failure to comply with these requirements.

GENERAL.

This product is a Safety Class 1 instrument (provided with a protective earth terminal). The protective features of this product may be impaired if it is used in a manner not specified in the operation instructions.

Any LEDs used in this product are Class 1 LEDs as per IEC 825-1.

This ISM device complies with Canadian ICES-001.

Cet appareil ISM est conforme à la norme NMB-001 du Canada.

ENVIRONMENTAL CONDITIONS.

This instrument is intended for indoor use in an installation category II, pollution degree 2 environment. It is designed to operate at a maximum relative humidity of 95% and at altitudes of up to 2000 meters. Refer to the specifications tables for the ac mains voltage requirements and ambient operating temperature range.

BEFORE APPLYING POWER.

Verify that the product is set to match the available line voltage and the correct fuse is installed.

GROUND THE INSTRUMENT.

This product is a Safety Class 1 instrument (provided with a protective earth terminal). To minimize shock hazard, the instrument chassis and cabinet must be connected to an electrical ground. The instrument must be connected to the ac power supply mains through a three-conductor power cable, with the third wire firmly connected to an electrical ground (safety ground) at the power outlet. Any interruption of the protective (grounding) conductor or disconnection of the protective earth terminal will cause a potential shock hazard that could result in personal injury.

ATTENTION: Un circuit de terre continu est essentiel en vue du fonctionnement sécuritaire de l'appareil. Ne jamais mettre l'appareil en marche lorsque le conducteur de mise à la terre est débranché.

FUSES.

Only fuses with the required rated current, voltage, and specified type (normal blow, time delay, etc.) should be used. Do not use repaired fuses or short circuited fuseholders. To do so could cause a shock or fire hazard.

DO NOT OPERATE IN AN EXPLOSIVE ATMOSPHERE.

Do not operate the instrument in the presence of flammable gases or fumes.

KEEP AWAY FROM LIVE CIRCUITS.

Operating personnel must not remove instrument covers. Component replacement and internal adjustments must be made by qualified service personnel. Do not replace components with power cable connected. Under certain conditions, dangerous voltages may exist even with the power cable removed. To avoid injuries, always disconnect power, discharge circuits and remove external voltage sources before touching components.

DO NOT SERVICE OR ADJUST ALONE.

Do not attempt internal service or adjustment unless another person, capable of rendering first aid and resuscitation, is present.

DO NOT EXCEED INPUT RATINGS.



















This instrument may be equipped with a line filter to reduce electromagnetic interference and must be connected to a properly grounded receptacle to minimize electric shock hazard. Operation at line voltages or frequencies in excess of those stated on the data plate may cause leakage currents in excess of 5.0 mA peak.

DO NOT SUBSTITUTE PARTS OR MODIFY INSTRUMENT.

Because of the danger of introducing additional hazards, do not install substitute parts or perform any unauthorized modification to the instrument. Return the instrument to an Agilent Technologies Sales and Service Office for service and repair to ensure that safety features are maintained.

Instruments which appear damaged or defective should be made inoperative and secured against unintended operation until they can be repaired by qualified service personnel.

SAFETY SYMBOL DEFINITIONS

Symbol	Description	Symbol	Description
	Direct current		Terminal for Line conductor on permanently installed equipment
	Alternating current		Caution, risk of electric shock
	Both direct and alternating current		Caution, hot surface
	Three-phase alternating current		Caution (refer to accompanying documents)
	Earth (ground) terminal		In position of a bi-stable push control
	Protective earth (ground) terminal		Out position of a bi-stable push control
	Frame or chassis terminal		On (supply)
	Terminal for Neutral conductor on permanently installed equipment		Off (supply)
	Terminal is at earth potential (Used for measurement and control circuits designed to be operated with one terminal at earth potential.)		Standby (supply) Units with this symbol are not completely disconnected from ac mains when this switch is off. To completely disconnect the unit from ac mains, either disconnect the power cord or have a qualified electrician install an external switch.

Herstellerbescheinigung

Diese Information steht im Zusammenhang mit den Anforderungen der Maschinenläminformationsverordnung vom 18 Januar 1991.

* Schalldruckpegel $L_p < 70 \text{ dB(A)}$ * Am Arbeitsplatz * Normaler Betrieb * Nach EN 27779 (Typproofung).

Manufacturer's Declaration

This statement is provided to comply with the requirements of the German Sound Emission Directive, from 18 January 1991.

* Sound Pressure $L_p < 70 \text{ dB(A)}$ * At Operator Position * Normal Operation * According to EN 27779 (Type Test).

Printing History

The current edition of this guide is indicated below. Reprints of this guide containing minor corrections and updates may have the same printing date. New editions are identified by a new printing date and, in some cases, by a new part number. A new edition incorporates all new or corrected material since the previous edition. Changes to the guide occurring between editions are covered by change sheets shipped with the guide. Also, if the serial number prefix of your power module is higher than those listed on the title page of this guide, then it may or may not include a change sheet. That is because even though the higher serial prefix indicates a design change, that change may not affect the content of the guide.

Edition 1 May, 1991

Edition 2..... May 1993

..... November, 1997

..... April 2000; September 2004

© Copyright 1993 Agilent Technologies, Inc.

This document contains proprietary information protected by copyright. All rights are reserved. No part of this document may be photocopied, reproduced, or translated into another language without the prior consent of Agilent Technologies. The information contained in this document is subject to change without notice.



DECLARATION OF CONFORMITY

According to ISO/IEC Guide 22 and CEN/CENELEC EN 45014



Manufacturer's Name and Address

Responsible Party

Agilent Technologies, Inc.
550 Clark Drive, Suite 101
Budd Lake, New Jersey 07828
USA

Alternate Manufacturing Site

Agilent Technologies (Malaysia) Sdn. Bhd
Malaysia Manufacturing
Bayan Lepas Free Industrial Zone, PH III
11900 Penang,
Malaysia

Declares under sole responsibility that the product as originally delivered

Product Names Single input dc Electronic Loads

Model Numbers 6060B; 6063B
(and other customized products based upon the above)

Product Options This declaration covers all options and customized products based on the above products.

Complies with the essential requirements of the Low Voltage Directive 73/23/EEC and the EMC Directive 89/336/EEC (including 93/68/EEC) and carries the CE Marking accordingly.

EMC Information ISM Group 1 Class A Emissions

As detailed in Electromagnetic Compatibility (EMC), Certificate of Conformance Number CC/TCF/00/080 based on Technical Construction File (TCF) HPNJ7, dated Oct. 29, 1997

Assessed by: Celestica Ltd, Appointed Competent Body
Westfields House, West Avenue
Kidsgrove, Stoke-on-Trent
Straffordshire, ST7 1TL
United Kingdom

Safety Information and Conforms to the following safety standards.

IEC 61010-1:2001 / EN 61010-1:2001
UL 1244
CSA C22.2 No. 1010.1:1992

This DoC applies to above-listed products placed on the EU market after:

January 1, 2004

Date

Bill Darcy/ Regulations Manager

For further information, please contact your local Agilent Technologies sales office, agent or distributor.

Authorized EU-representative: Agilent Technologies Deutschland GmbH, Herrenberger Straße 130, D71034 Böblingen, Germany

Table of Contents

1.	General Information	
	What's in this Manual	9
	Reader Path	9
	Options	9
	Safety Requirements.....	10
	Specifications	10
2.	Operation Overview	
	Introduction	19
	Front Panel Description.....	19
	Remote Programming.....	19
	Local/Remote Control	20
	Programmable Features	20
	Modes of Operation.....	20
	Constant Current CC (Mode)	20
	Constant Resistance (CR) Mode.....	22
	Constant Voltage (CV) Mode.....	23
	Transient Operation	24
	Triggered Operation	27
	Slew Rate and Minimum Transition Time.....	27
	Input Current, Voltage, and Power Measurement	28
	Short On/Off.....	29
	Input On/off.....	30
	Saving and Recalling Settings	30
	Reading Remote Programming Errors.....	30
	Status Reporting	30
	Protection Features	31
	Resetting Latched Protection.....	31
	Overvoltage	31
	Overcurrent.....	31
	Overpower	32
	Overtemperature.....	32
	Reverse Voltage	32
	Control Connector	32
	Remote Sensing	32
	Monitor Outputs	33
	External Programming Input	33
	Fault.....	33
	Port On/Off.....	34
3.	Installation	
	Introduction	35
	Inspection	35
	Location and Cooling	36
	Turn-On Checkout.....	36
	Check Line Voltage.....	36
	Connect the Power Cord.....	38
	Turn-On/Selftest	38
	Power Test.....	37

Table of Contents (continued)

Controller Connection	39
GPIB Connector	39
GPIB Address.....	40
Rear Panel Connectors and Switches	40
Input Binding Posts	40
Control Connector	41
Trigger Connector	43
Sense Switch.....	43
Application Connections	44
Wiring Considerations.....	44
Local Sense Connections.....	44
Remote Sense Connections	44
Parallel Connections.....	45
Zero-Volt Loading Connections.....	45
4. Local Operation	
Introduction	49
Local Control Overview	52
Using The Function Keys.....	53
Turning the Input On/Off	53
Setting the Mode of Operation	55
Setting CC Values	55
Setting CR Values	57
Setting CV Values	59
Transient Operation.....	60
Shorting the Input.....	61
Resetting Latched Protection.....	61
Using The System Keys.....	61
Setting the GPIB Address.....	62
Displaying Error Codes	62
Saving and Recalling Settings	62
Changing "Wake-up" Settings.....	63
Recalling the Factory Default Values.....	64
5. Remote Operation	
Introduction	65
Enter/Output Statements.....	65
GPIB Address.....	65
Sending A Remote Command	66
Getting Data Back From The Electronic Load	66
Remote Programming Commands.....	66
CC Mode Example	70
CV Mode Example	70
CR Mode Example	70
Continuous Transient Operation Example.....	71
Pulsed Transient Operation Example	71
6. Calibration	
Introduction	75
Example Programs	75
Equipment Required.....	75

Table of Contents (continued)

Calibration Commands	76
Calibration Flowcharts	77
Example Program	77
A. Considerations for Operating in Constant Resistance Mode	87
Index	89
Agilent Sales and Support Offices	93

General Information

What's In This Manual

This chapter contains specifications that apply to the Single Input Electronic Load Family as well as information concerning options and safety requirements. The remaining chapters in this manual contain instructions for installing, operating, programming, and calibrating the Electronic Load as follows:

Chapter 2 "Operation Overview":	describes all of the Electronic Load's functions and briefly describes how they can be controlled locally at the front panel and/or remotely via a GPIB controller.
Chapter 3 "Installation":	includes turn-on checkout procedures as well as controller and application connections.
Chapter 4 "Local Operation":	describes in detail how to operate the Electronic Load at the front panel.
Chapter 5 "Remote Operation":	provides an introduction to remote programming.
Chapter 6 "Calibration":	contains calibration procedures for the Electronic Load and gives sample calibration programs. Yearly calibration intervals are recommended.

Reader Path

If you are a first-time user, start with this manual, paying particular attention to Chapter 2. After installation (Chapter 3), read Chapter 4 to learn front-panel operation. Programming users should then read Chapter 5 before going to the *Programming Reference Guide*. Experienced programming users will probably refer only to the *Programming Reference Guide*. The programming guide covers all of the programming details whereas Chapter 5 in this manual gives a few simple examples to help you get started in writing computer programs.

Options

Unless one of the following line voltage options is ordered, the unit is shipped from the factory set for 120 Vac, 48-63 Hz ac input power. If Option 100, 220, or 240 is ordered, the unit will be factory set for the appropriate line voltage. For information about changing the line voltage setting, see "Turn-On Checkout" in Chapter 3.

100: Input Power, 100 Vac, 48-63 Hz

220: Input Power, 220 Vac, 48-63 Hz

240: Input Power, 240 Vac, 48-63 Hz

Additional options are:

020: Front panel input binding posts

908: One rack mount kit

909: One rack mount kit with handles

910: One service manual with extra Operating Manual and Programming Reference Guide

Safety Requirements

This product is a Safety Class 1 instrument, which means that it is provided with a protective earth ground terminal. This terminal must be connected to an ac source that has a 3-wire ground receptacle. Review the instrument rear panel and this manual for safety markings and instructions before operating the instrument. Refer to the Safety Summary page at the beginning of this manual for a summary of general safety information. Specific safety information is located at appropriate places in this manual.

The Electronic Load is designed to comply with the following safety and environmental requirements:

- IEC 348 - Safety requirements for electronic measuring apparatus.
- CSA 22.2 No. 231 - Electronic instruments and scientific apparatus for special use and applications.
- UL 1244 - Electrical and electronic measuring and testing equipment.

Specifications

Table 1-1 lists the specifications of the Single Input Electronic Loads. Specifications indicate warranted performance in the $25^{\circ}\text{C} \pm 5^{\circ}\text{C}$ region of the total temperature range (0 to 55°C). Table 1-2 lists the supplemental characteristics of the Single Input Electronic Loads. Supplemental characteristics indicate nonwarranted, typical performance and are intended to provide additional information by describing performance that has been determined by design or type testing.

Table 1-1. Specifications

SPECIFICATIONS		
AC INPUT RATING: Two internal switches permit operation from 100, 120, 220, or 240 Vac, nominal lines.		
Amplitude: -13% to +6% nominal line voltage.		
Frequency: 48 to 63 Hz		
	6060B	6063B
DC INPUT RATING		
Current:	0 to 60 A	0 to 10 A
Voltage:	3 V to 60 V (see derated current detail)	3 V to 240 V (see derated current detail)
Power:	300 W at 40°C (derated to 225 W at 55°C)	250 W at 40°C (derated to 187 W at 55°C)
OPERATING CHARACTERISTICS		

Table 1-1. Specifications (continued)

DERATED CURRENT DETAIL

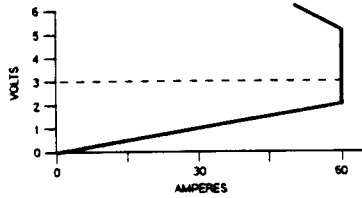

6060B

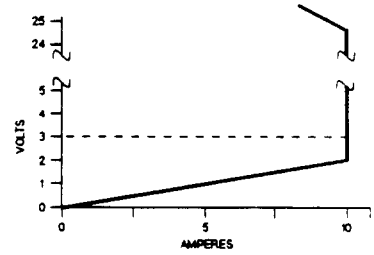

6063B

CONSTANT CURRENT MODE

Ranges

Low Range:

0 to 6 A

0 to 1 A

High Range:

0 to 60 A

0 to 10 A

Accuracy (after 30 sec wait):

$\pm 0.1\% \pm 75 \text{ mA}$
both ranges

$\pm 0.15\% \pm 10 \text{ mA}$
both ranges

Regulation:

10 mA both ranges

8 mA both ranges

CONSTANT RESISTANCE MODE

Ranges

Low Range:

0.033 to 1 Ω

0.20 to 24 Ω

Middle Range:

1 to 1000 Ω

24 to 10,000 Ω

High Range:

10 to 1 0,000 Ω

240 to 50,000 Ω

Accuracy

Low Range:

$\pm 0.8\% \pm 8 \text{ m}\Omega$
with $\geq 6 \text{ A}$ at input

$\pm 0.8\% \pm 200 \text{ m}\Omega$
with $\geq 1 \text{ A}$ at input

Middle and High Ranges:

$\pm 0.3\% \pm 8 \text{ mS}$
with $\geq 6 \text{ V}$ at input

$\pm 0.3\% \pm 0.3 \text{ mS}$
with $\geq 24 \text{ V}$ at input

CONSTANT VOLTAGE MODE

Range:

0 to 60 V

0 to 240 V

Accuracy:

$\pm 0.1\% \pm 50 \text{ mv}$

$\pm 0.12\% \pm 120 \text{ mV}$

Regulation:

10 mV (remote sense),
40 mV (local sense)

10 mV (remote sense),
40 mV (local sense)

TRANSIENT OPERATION

Modes:

Continuous, pulsed, or toggled

Continuous Mode

Freq Range:

0.25 Hz to 10 kHz

Freq Accuracy:

3%

Duty Cycle Range:

3% to 97% (0.25 Hz to 1 kHz);
6% to 94% (1 kHz to 10 kHz)

Duty Cycle Accuracy:

6% of setting $\pm 2\%$

Pulsed Mode

Pulse Width:

50 μs $\pm 3\%$ minimum; 4 s $\pm 3\%$ maximum

Table 1-1. Specifications (continued)

	6060B	6063B
TRANSIENT CURRENT LEVEL		
Ranges		
Low Range:	0 to 6 A	0 to 1 A
High Range:	0 to 60 A	0 to 10 A
Accuracy		
Low Range:	± 0.1% ± 80 mA	± 0.18% ± 13 mA
High Range:	± 0.1% ± 350 mA	± 0.18% ± 50 mA
TRANSIENT RESISTANCE LEVEL		
Ranges		
Low Range:	0.033 to 1 Ω	0.20 to 24 Ω
Middle Range:	1 to 1000 Ω	24 to 10,000 Ω
High Range:	10 to 10,000 Ω	240 to 50,000 Ω
Accuracy		
Low Range:	±0.8% ± 10 m Ω with ≥ 6 A at input	± 0.8% ± 200 m Ω with ≥ 1 A at input
Middle Range:	± 0.3% ± 10 mS with ≥ 6 V at input	± 0.3% ± 0.5 mS with ≥ 24 V at input
High Range:	± 0.3% ± 10 mS with ≥ 6 V at input	± 0.3% ± 0.4 mS with ≥ 24 V at input
TRANSIENT VOLTAGE LEVEL		
Range:	0 to 60 V	0 to 240 V
Accuracy:	0.1% ± 300 mV	± 0.15% ± 1.1 V
CURRENT READBACK		
*Accuracy:	0.05% ± 65 mA	± 0.12% ± 10mA
*after 30 second wait.		
VOLTAGE READBACK		
Accuracy:	0.05% ± 45 mV	± 0.1% 150 mV
POWER READBACK		
Accuracy	±0.2% ± 4 W	±0.2% ± 3 W
PARD (20 Hz to 10 MHz noise)		
Current:	4 mA rms/40 mA p-p	1 mA rms/10 mA p-p
Voltage:	6 mV rms	6 mV rms

Table 1-2. Supplemental Characteristics

	6060B	6063B
CONSTANT CURRENT MODE		
Resolution		
Low Range:	1.6 mA	0.26 mA
High Range:	16 mA	2.6 mA
Temperature Coefficient	100 ppm/°C ± 5 mA/°C both ranges	150 ppm/°C ± 1 mA/°C both ranges
CONSTANT RESISTANCE MODE		
Resolution		
Low Range:	0.27 mΩ	6 mΩ
Middle Range:	0.27 mS	0.011 mS
High Range:	0.027 mS	0.001 mS
Temperature Coefficient		
Low Range:	800 ppm/°C ± 0.4 mΩ/°C	800 ppm/°C ± 10 mΩ/°C
Middle and High Ranges:	300 ppm/°C ± 0.6 m S/°C	300 ppm/°C ± 0.03 mS/°C
CONSTANT VOLTAGE MODE		
Resolution:	16 mV	64 mV
Temperature Coefficient:	100 ppm/°C ± 5mV/°C	120 ppm/°C ± 10mV/°C
TRANSIENT OPERATION		
Continuous Mode		
Freq Resolution:	4%	4%
Duty Cycle Resolution:	4%	4%
TRANSIENT CURRENT LEVEL		
Resolution		
Low Range:	26 mA	4 mA
High Range:	260 mA	43 mA
Temperature Coefficient:	100 ppm/°C ± 7 mA/°C	180 ppm/°C ± 1.2 mA/°C
TRANSIENT RESISTANCE LEVEL		
Resolution		
Low Range:	4.3 mΩ	100 mΩ
Middle Range:	4.3 mS	0.18 mS
High Range:	0.4 mS	0.018 mS
TRANSIENT VOLTAGE LEVEL		
Resolution:	260 mV	1.0 V
Temperature Coefficient:	150 ppm/°C ± 5 mA/°C	120 ppm/°C ± 10 mA/°C
CURRENT READBACK		
Resolution:	17 mA (via GPIB) 20 mA (front panel)	27 mA (via GPIB) 10 mA (front panel)
Temperature Coefficient:	50 ppm/°C ± 5 mA/°C	100 ppm/°C ± 1 mA/°C

Table 1-2. Supplemental Characteristics (continued)

	6060B	6063B
VOLTAGE READBACK		
Resolution:	17 mV (via GPIB) 20 mV (front panel)	67 mV (via GPIB) 100 mV (front panel)
Temperature Coefficient:	50 ppm/°C ± 1.2 mV/°C	100 ppm/°C ± 8 mV/°C
Maximum Readback Capability:	65 to 70 V (typical)	260 V (typical)
EXTERNAL ANALOG PROGRAMMING		
	(0 to 10 Vdc or 0 to 10 Vac)	
Bandwidth:	10 kHz (3 db frequency)	
Accuracy		
Low Current Range:	± 4.5% ± 75 mA	± 3% ± 10 mA
High Current Range:	± 4.5% ± 250 mA	± 3% ± 20 mA
Voltage Range:	± 0.8% ± 200 mV	± 0.5% ± 150 mV
Temperature Coefficient		
Current Range:	100 ppm/° ± 6 mA/°C	150 ppm/°C ± 1 mA/°C
Voltage Range:	100 ppm/°C ± 1 mV/°C	120 ppm/°C ± 10 mV/°C
EXTERNAL CURRENT MONITOR (0 TO 10 V):		
Accuracy	± 4% ± 85 mA*	± 3% ± 10 mA*
Temperature Coefficient	50 ppm/°C ± 6 mA/°C	100 ppm/°C ± 1 mA/°C
*referenced to Analog Common		
EXTERNAL VOLTAGE MONITOR (0 TO 10 V):		
Accuracy	± 0.25% ± 40 mV*	0.4% ± 240 mV*
Temperature Coefficient	50 ppm/°C ± 0.2 mV/°C	70 ppm/°C ± 1.2 mV/°C
*referenced to Analog Common		
MAXIMUM INPUT LEVELS		
Current:	61.2 A*	10.2 A*
Voltage:	75 V	250 V
*programmable to lower limits.		
DC FLOATING VOLTAGE (DC ISOLATION):		
± 240 Vdc between + or - input binding post and chassis ground		
DIGITAL INPUTS		
Vlo: 0.9 V maximum at Ilo = -1 mA		
Vhi: 3.15 V minimum (pull-up resistor on input)		
DIGITAL OUTPUTS		
Vlo: 0.72 V maximum at Ilo = 1 mA		
Vhi: 4.4 V maximum at Ilo = -20 µA		
INPUT CURRENT:		
100 Vac - 400 mA		
120 Vac - 350 mA		
220 Vac - 200 mA		
240 Vac - 180 mA		

Table 1-2. Supplemental Characteristics (continued)

Fuse: The ac input is protected by a fuse located in a module on the rear panel; 0.5AM for 100/120 Vac input; 0.25AM for 220/240 Vac input.

Maximum VA: 60

Peak Inrush Current: 2.5 A (typical)

PROGRAMMABLE SLEW RATE: (For any given input transition, the time required will be either the total slew time or a minimum transition time, whichever is larger. The minimum transition time increases when operating with input currents under 1 AM (6060B) or 0.2 AM (6063B) and decreases with input currents over 20 A (6060B) or 2 A (6063B). The following are typical values; $\pm 25\%$ tolerance.)

Current Slew Rate:

Model 6060B (Ac performance specified from 3 to 60 V)

Rate #	High Range Step	Low Range Step	Transition Time
1	1 A/ms	0.1 A/ms	8.0 ms
2	2.5 A/ms	0.25 A/ms	3.2 ms
3	5 A/ms	0.5 A/ms	1.6 ms
4	10 A/ms	1 A/ms	800 μ s
5	25 A/ms	2.5 A/ms	320 μ s
6	50 A/ms	5 A/ms	160 μ s
7	0.1 A/ μ s	10 A/ms	80 μ s
8	0.25 A/ μ s	25 A/ms	32 μ s
9	0.5 A/ μ s	50 A/ms	16 μ s
10	1 A/ μ s	0.1 A/ μ s	12 μ s
11	2.5 A/ μ s	0.25 A/ μ s	12 μ s
12	5 A/ μ s	0.5 A/ μ s	12 μ s

Model 6063B (Ac performance specified from 3 to 240 V)

Rate #	High Range Step	Low Range Step	Transition Time
1	0.17 A/ms	17 A/s	8.0 ms
2	0.42 A/ms	42 A/s	3.2 ms
3	0.83 A/ms	83 A/s	1.6 ms
4	1.7 A/ms	0.17 A/ms	800 μ s
5	4.2 A/ms	0.42 A/ms	320 μ s
6	8.3 A/ms	0.83 A/ms	160 μ s
7	17 A/ms	1.7 A/ms	80 μ s
8	42 A/ms	4.2 A/ms	32 μ s
9	83 A/ms	8.3 A/ms	20 μ s
10	0.17 A/ μ s	17 A/ms	20 μ s
11	0.42 A/ μ s	42 A/ms	16 μ s
12	0.83 A/ μ s	83 A/ms	16 μ s

Table 1-2. Supplemental Characteristics (continued)

Voltage Slew Rate:

Rate #	6060B (0 to 60V) Voltage Step	6063B (0 to 240V) Voltage Step	Transition Time*
1	1 V/ms	4 V/ms	8.0 ms
2	2.5 V/ms	10 V/ms	3.2 ms
3	5 V/ms	20 V/ms	1.6 ms
4	10 V/ms	40 V/ms	800 μ s
5	25 V/ms	100 V/ms	320 μ s
6	50 V/ms	200 V/ms	160 μ s
7	0.1 V/ μ s	0.4 V/ μ s	100 μ s
8	0.25 V/ μ s	1 V/ μ s	100 μ s
9	0.5 V/ μ s	2 V/ μ s	100 μ s

*Transition time is based on low capacitance current source.

Resistance Slew Rate

Low Range: Uses the value programmed for the voltage slew rate.
 Middle and High Ranges: Uses the value programmed for the current slew rate.

TRANSIENT CURRENT OVERSHOOT (When programmed from 0A):

Model 6060B

Range	Transient Current Level	Current Slew Rate	Overshoot*
60 A	6-60 A	All slew rates	0
	3 A	1 A/ μ s to 5 A/ μ s	1%
	3 A	1 A/ms to 0.5 A/ μ s	0
6 A	6 A	All slew rates	0
	3 A	0.25 A/ μ s and 0.5 A/ μ s	1%
	3 A	0.1 A/ms to 0.1 A μ s	0

Model 6063B

Range	Transient Current Level	Current Slew Rate	Overshoot*
10A	2-10 A	All slew rates	0
	0.5 A	0.17 A/ μ s to 0.83 A/ μ s	5%
	0.5 A	0.17 A/ms to 42 A/ms	0
	1 A	0.83 A/ μ s	1%
	1 A	0.17 A/ms to 0.17 A/ μ s	0
1 A	0.5 A	83 A/ms	4%
	0.5 A	17 A/s to 17 A/ms	0
	1 A	All slew rates	0

*All overshoot values assume a total inductance of 1 μ H, or less, in the load leads connected to the D.U.T. For Model 6060B, overshoot may be higher during first five seconds of programming if the unit has been operating at full current.

Table 1-2. Supplemental Characteristics (continued)

	6060B <10%	6063B <5%
SOURCE TURN-ON CURRENT OVERTHROTT (In CC and CR modes when connected to power supplies with voltage rise times of greater than 500 μ s)		
PROGRAMMABLE SHORT CIRCUIT	0.033 ohm (0.02 ohm typ)	0.20 ohm (0.10 ohm typ)
PROGRAMMABLE OPEN CIRCUIT	20 k (typical)	80 k (typical)
DRIFT STABILITY (Over an 8 hour interval)		
Current:	$\pm 0.03\% \pm 10$ mA	$\pm 0.03\% \pm 15$ mA
Voltage:	$\pm 0.01\% \pm 10$ mV	$\pm 0.01\% \pm 20$ mV
REVERSE CURRENT CAPACITY		
With unit on:	100 A	20 A
With unit off:	40 A	10 A
GPIB PROGRAMMING COMMAND PROCESSING TIME (Typical time required for a GPIB command to be processed by the Electronic Load.)		
	70 ms	
GPIB CAPABILITIES		
	SH1, AH1, T6, L4, SR1, RL1, DT1, DC1	
WEIGHT		
	6.12 kg (13.5 lb) net; 8.16 kg (18 lb) shipping	
DIMENSIONS		
Width:	425.5 mm (16.75 in)	
Height:	88.1 mm (3.5 in)	
Depth:	346 mm (13.6 in), not including 50 mm for binding posts	

Operation Overview

Introduction

The Electronic Load is used for design, manufacturing, and evaluation of dc power supplies, batteries, and power components. The primary operating features of the Electronic Load are: constant current (CC) mode, constant voltage (CV) mode, or constant resistance (CR) mode. The input can also be turned on or off (open circuit) or short circuited.

Other features include a built-in GPIB interface and a built-in pulse generator. Pulse mode allows dynamic testing of power supplies and components, without giving the device under test time to heat up. This flexible mode provides three triggering methods, allowing synchronization with a wide variety of events. A Save/Recall feature allows you to save up to 7 complete instrument setups, one of which can be saved in non-volatile memory so that it is recalled automatically at power-on. Also standard is GPIB readback of actual input voltage and current, and extensive protection and status reporting capability.

The Electronic Load contains a fan whose speed automatically increases or decreases as the heatsink temperature rises and falls. This reduces the overall noise level because the fan does not run at maximum speed at all times.

The input power rating curve for the Electronic Load is shown in Table 1-1. Refer to the extended power paragraphs in this section for a description of the power rating curves. Note that regardless of the power rating, input current is derated linearly from 2 volts down to 0 volts.

If your application requires a greater power or current capacity than one Electronic Load can provide, Electronic Loads can be connected in parallel in CC or CR mode.

Front Panel Description

The front panel includes a 12-character alphanumeric display, 11 status indicators, and three groups of keypads. Ordinarily the alphanumeric display shows the input voltage and current. By using the **Meter** key you can sequentially display input power, programming error codes, and protection-circuit status. If any protection circuits are active, that status will be displayed first when you use the **Meter** key. The alphanumeric display shows what function is being performed when you use the keypads.

The display also includes 11 annunciators that point to the 11 status labels printed on the front panel. These are: Constant Current, Constant Resistance, Constant Voltage, Transient, Unregulated, Protection, Error, Shift, Remote, Address, and Service ReQuest.

Three keys perform two functions, with the alternative function labeled in blue above the key. The alternative function is selected by first pressing the blue (shift) key, which turns on the Shift annunciator and enables the alternative function.

Remote Programming

Commands sent to the Electronic Load via GPIB are decoded by the primary microprocessor, which detects syntax and range errors. The primary processor also prescales data and maintains the status registers. Three commands have aliases for compatibility with other HPSL instruments. MODE can also be called FUNCtion, INPut can also be called OUTPut, and INSTRument can also be called CHANnel. OUTPut and INSTRument would typically be used if you want your program to refer to the Electronic Load in terms of the device or instrument under test. When using the CHANnel command, remember that the Electronic Load is always channel 1.

Local/Remote Control

Local (front panel) control is in effect immediately after power is applied. The front panel keypad and display allow manual control when the Electronic Load is used in bench test applications. Remote (computer) control goes into effect (front panel **Rmt** annunciator is on) as soon as the Electronic Load receives a command via the GPIB. A built-in GPIB interface and HPSL compatible commands allow control and readback of all functions when the Electronic Load is used in computer controlled applications.

With remote control in effect, only the computer can control the Electronic Load; the front panel keypad has no effect. You can, however, still use the front panel display to view the input voltage and current readings. You can return the Electronic Load to local control from remote control by pressing **Local**. This will return the Electronic Load to local control, unless the local-lockout command has been received from the GPIB computer.

Details of local operation are covered in Chapter 4 and fundamentals of remote programming are given in Chapter 5. Complete HPSL programming details are given in the Programming Reference Guide. The remaining paragraphs in this chapter describe the operating modes, transient operation, protection features, and other operating features of the Electronic Load.

Programmable Features

Modes of Operation

The three modes of operation are:

- constant current (CC)
- constant voltage (CV)
- constant resistance (CR)

When programmed to a mode, the Electronic Load remains in that mode until the mode is changed or until a fault condition, such as an overpower or overtemperature, occurs. When changing modes, the load's input is disabled for approximately 6 milliseconds (non-conducting state) before the new mode is enabled. This insures that there will be minimum overshoots when changing modes.

The current, resistance, and voltage mode parameters described in subsequent paragraphs can be programmed whether or not the mode is presently selected. When a mode is selected via the front panel or via the GPIB, most of the associated parameters will take effect at the input (exceptions are noted in the mode descriptions).

Constant Current CC (Mode)

In this mode, the load will sink a current in accordance with the programmed value regardless of the input voltage (see Figure 2-1). The CC mode can be set with front panel keys (**MODE**, **CURR**, and **Enter**) or via the GPIB (**MODE:CURR** command). The CC mode parameters are discussed in the following paragraphs.

Ranges

Current may be programmed in either of two overlapping ranges, a low range and a high range. The low range provides better resolution at low current settings. The range can be set at the front panel (**CURR**, **Range** and **ENTRY** keys) or via the GPIB (**CURR:RANG** command). Any value in the low range selects the low range. Any value above the maximum of the low range selects the high range. Changing the range affects the load in the same manner as changing modes; i.e., it causes the input to go through a non-conducting state for approximately 0.2 milliseconds. Note that the values of the present current settings may be automatically adjusted to fit the new range. For example, if 10 A is the present setting and the 0 to 6 A range is then programmed, the current setting will automatically be changed to 6 A; see Chapter 4.

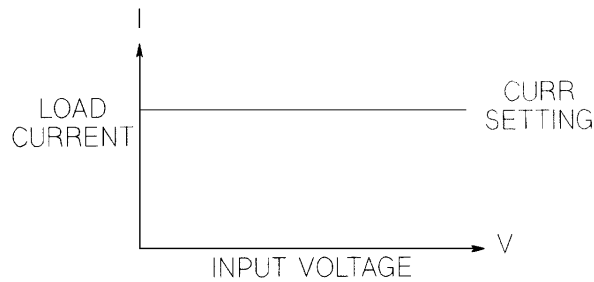

Figure 2-1. Constant Current Mode

Immediate Current Level

The current level can be set at the front panel (**CURR** and ENTRY keys) or via the GPIB (**CURR** command). If the CC mode is the active mode, the new setting immediately changes the input at a rate determined by the slew setting (described below). If the load is not in the CC mode, the new setting is saved for use when the mode is changed to CC.

Triggered Current Level

The current level can be preset (stored in the Electronic Load) allowing the input to be updated when a trigger is received instead of immediately as previously described. The current level can only be preset via the GPIB (**CURR:TRIG** command). The preset capability is not available at the front panel.

If the CC mode is the active mode, the preset current level will become the actual value and the input will be updated when a trigger occurs. If the CC mode is not the active mode, the preset current level will become the actual value when a trigger occurs but there will be no effect on the input until the CC mode becomes active. Once a level is triggered, subsequent triggers will have no effect on the input unless another **CURR:TRIG** command is sent. The trigger sources available to the Electronic Load are described later in this chapter. The Electronic Load has a status reporting capability to keep track of pending triggers and other operating conditions. The status reporting capability is described in detail in the Programming Reference Guide.

Transient Current Level

The transient current level can be set at the front panel (**CURR**, **Tran Level** and ENTRY keys) or via the GPIB (**CURR:TLEV** command). The transient current level determines the higher current level when transient operation (described later in this chapter) is turned on. The load will switch between the main level and the transient level when transient operation is turned on.

Software Current Limit

The Electronic Load allows the user to set a current limit from 0 to 102% of full scale via the GPIB (**CURR:PROT** command), which will shut down the input if the current limit is exceeded beyond a programmable time delay. Note that the software current limit is in effect for any mode of operation (not just the CC mode). The software current limit feature is described later in this chapter under *Protection Features*.

Slew Rate

Slew rate determines the rate at which the input level changes to a new programmed value. Slew rate can be set at the front panel (**CURR**, **Slew** and ENTRY keys) or via the GPIB (**CURR:SLEW** command). This slew rate remains in effect for the immediate, triggered, and transient level changes previously described.

There are 12 discrete current slew rates within each slew-rate range. Any slew rate value can be sent to a load (there are no upper and lower limits that would cause an error), and a load will automatically select one of the 12 rates that is closest to the programmed value. The slew rate is rescaled to the closest fit in the 1-of-12 discrete steps if the current range is changed.

Constant Resistance (CR) Mode

In this mode, the load will sink a current linearly proportional to the input voltage in accordance with the programmed resistance (see Figure 2-2). The CR mode can be set at the front panel (**MODE**, **RES** and **Enter** keys) or via the GPIB (**MODE:RES** command). The CR mode parameters are described in the following paragraphs.

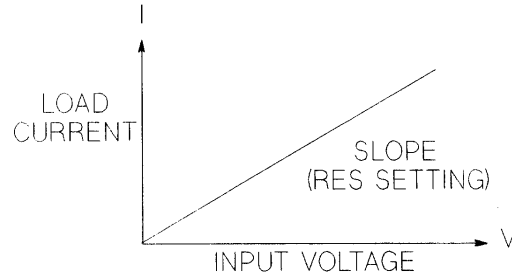

Figure 2-2. Constant Resistance Mode

Ranges

Resistance may be programmed in any of three overlapping ranges (low, middle, high). The range can be set at the front panel (**RES**, **Range**, and ENTRY keys) or via the GPIB (**RES:RANG** command). Any value in the low range selects the low range. Any value that is within the middle range and above the maximum low-range value selects the middle range. Any value that is within the high range and above the maximum middle-range value selects the high range. Note that the values of the present resistance settings may be automatically adjusted to fit within the new range.

Immediate Resistance Level

The resistance level can be set at the front panel (**RES** and ENTRY keys) or via the GPIB (**RES** command). If the CR mode is the active mode, the new setting immediately changes the input at a rate determined by the voltage or current slew setting (see description below). If the load is not in the CR mode, the new setting is saved for use when the mode is changed to CR.

Triggered Resistance Level

The resistance level can be preset (stored in the Electronic Load) allowing the input level to change when a trigger is received instead of immediately as previously described. The resistance level can only be preset via the GPIB (**RES:TRIG** command). The preset capability is not available at the front panel.

If the CR mode is the active mode, the preset resistance level will become the actual value and the input will be updated when a trigger occurs. If the CR mode is not the active mode, the preset resistance level will become the actual value when a trigger occurs but there will be no effect on the input until the CR mode becomes active. Once a level is triggered, subsequent triggers will have no effect on the input unless another **CURR:TRIG** command is sent.

Transient Resistance Level

The transient resistance level can be set at the front panel (**RES**, **Tran Level** and ENTRY keys) or via the GPIB (**RES:TLEV** command). The transient level and the main level are used in transient operation, which is described later in this chapter. In the low resistance range, the transient level must be set to a **higher** resistance value than the main level. However, in the middle and high resistance ranges, the transient level must be set to a **lower** resistance value than the main level.

Slew Rate

Slew rate in resistance mode is not programmed in ohms/second. In the low resistance range, slew rate is programmed in volts/second. Whatever value is programmed for the voltage slew rate is also used for the low resistance range.

In the middle and high resistance ranges, slew rate is programmed in amps/second. Whatever value is programmed for the current slew rate is also used for the middle or high resistance ranges.

Constant Voltage (CV) Mode

In this mode, the load will attempt to sink enough current to control the source voltage to the programmed value (see Figure 2-3). The load acts as a shunt voltage regulator when operating in the CV mode. The CV mode can be set at the front panel (**MODE**, **VOLT** and **Enter** keys) or via the GPIB (**MODE:VOLT** command). The CV mode parameters are described in the following paragraphs.

Range

Voltage mode has only one range

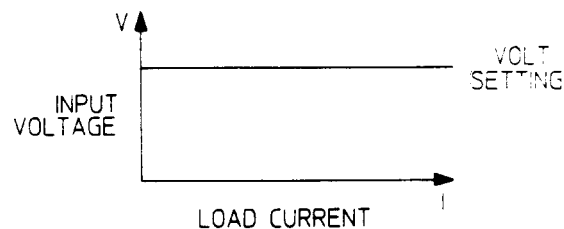

Figure 2-3. Constant Voltage Mode

Immediate Voltage Level

The voltage level can be set at the front panel (**VOLT** and ENTRY keys) or via the GPIB (**VOLT** command). If the CV mode is the active mode, the new setting immediately changes the input level at a rate determined by the voltage slew setting. If the load is not in the CV mode, the new setting is saved for use when the mode is changed to CV.

Triggered Voltage Level

The voltage level can be preset (stored in the Electronic Load) allowing the input level to change when a trigger is received instead of immediately as previously described. The voltage level can only be preset via the GPIB (**VOLT:TRIG** command).

Transient Voltage Level

The transient voltage level can be set at the front panel (**VOLT**, **Tran Level** and ENTRY keys) or via the GPIB (**VOLT:TLEV** command). The load input will switch between the main level and the transient level when transient operation is turned on. The transient voltage level determines the higher voltage level.

Slew Rate

Slew rate determines the rate at which the voltage changes to a new programmed setting. Slew rate can be set at the front panel (**VOLT**, **Slew**, and ENTRY keys) or via the GPIB (**VOLT:SLEW** command). This slew rate remains in effect for the immediate, triggered and transient voltage level changes described above.

There are 12 discrete slew rates that can be programmed for CV Mode slew rate. Any slew-rate value can be sent to the load (there are no upper and lower limits that would cause an error). The load will automatically select one of the 12 rates that is closest to the programmed value. It is important to note that the fastest slew rates cannot be achieved because of bandwidth limitations (refer to the specifications table).

Transient Operation

Transient operation enables the load to periodically switch between two load levels, as might be required for testing power supplies. A power supply's regulation and transient characteristics can be evaluated by monitoring the supply's output voltage under varying combinations of load levels, frequency, duty cycle, and slew rate. Transient operation can be turned on and off at the front panel (**Tran On/Off** key) or via the GPIB (**TRAN ON** and **TRAN OFF** commands). Before you turn on transient operation, you should set the desired mode of operation as well as all of the parameters associated with transient operation. Transient operation may be used in the CC, CR, or CV modes and can be continuous, pulsed, or toggled. Note that the pulsed or toggled operation cannot be programmed from the front panel.

Continuous Transient Operation

In continuous operation, a repetitive pulse train switches between two load levels. Continuous transient operation is selected via the GPIB using the **TRAN:MODE CONT** command. For front panel operation, continuous transient operation is automatically selected when transient operation is turned on (**Tran On/Off** key).

The two load levels in the transient operation are the previously described main level (immediate or triggered) and transient level for current, resistance, or voltage. The rate at which the level changes is determined by the slew rate (see slew rate descriptions for CV, CR, or CV mode as applicable). In addition, the frequency and duty cycle of the continuous pulse train are programmable.

The frequency can be set from 0.25 to 10000 Hz at the front panel (**FREQ** and ENTRY keys) or via the GPIB (**TRAN:FREQ** command). The duty cycle can be set from 3% to 97% (0.25 Hz to 1 kHz) or from 6% to 94% (above 1 kHz) at the front panel (**Dcycle** and ENTRY keys) or via the GPIB (**TRAN:DCYC** command).

For example, assume that the CC mode is active, the slew rate is at the default setting (maximum rate), and the applicable transient operation parameters have been set as follows:

HPSL Command	Description
TRAN:MODE CONT	Sets continuous operation.
CURR 5	Sets main current level to 5 amps.
CURR:TLEV 10	Sets transient current level to 10 amps.
TRAN:FREQ 1000	Sets transient generator frequency to 1 kHz.
TRAN:DCYC 40	Sets transient generator duty cycle to 40%.
TRAN ON	Turns on transient operation.

Figure 2-4 shows the waveform that would result in this example. The load input current will slew to and remain at 10 amps for 40% of the period (400 μ s), then slew to and remain at 5 amps for the remaining 60% (600 μ s) of that cycle.

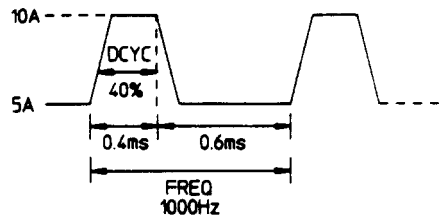

Figure 2-4. Continuous Transient Operation

The load starts conduction at the main level (in this case 5 amps). When transient operation is turned on and at a time specified by the frequency setting the input level starts increasing at a rate determined by the slew rate. When the value specified by the transient level setting is reached, it stays there for the remainder of the time determined by the frequency and duty cycle settings. After this time has elapsed, the input level decreases to the main level again at the rate specified by the slew setting and stays there for the remainder of the period prescribed by the frequency setting.

Pulsed Transient Operation

Pulsed transient operation is similar to continuous operation with the following exceptions:

- In order to get a pulse, an explicit trigger is required. The trigger can be an external trigger signal received via the TRIGGER input on the rear panel, the GPIB **GET** function, the ***TRG** common HPSL command, or the **TRIG** subsystem HPSL command.
- One pulse results from each trigger. Therefore, frequency cannot be programmed. The main level, transient level, and slew rate are programmed as described for continuous operation. The pulse width is programmable from 0.00005 to 4 seconds via the GPIB (**TRAN:TWID** command). Pulsed transient operation cannot be programmed at the front panel.
- There may be a delay between the generation of the trigger and the appearance of the pulse at the load's input. For pulse widths of 17 ms or greater, delay is less than 1.6% of the pulse width. For pulse widths of less than 17 ms, delay is less than 4% of the pulse width.

In this example, assume that the CC mode is active, the slew rate is at the factory default setting (maximum rate), an external trigger input is connected to the Electronic Load's rear panel, and the applicable transient operation parameters have been set as follows:

HPSL Command	Description
TRIG:SOUR EXT	Selects the external trigger input.
TRAN:MODE PULS	Selects pulsed transient operation.
CURR 5	Sets main current level to 5 amps.
CURR:TLEV 10	Sets transient current level to 10 amps.
TRAN:TWID .001	Sets pulse width to 1 millisecond.
TRAN ON	Turns on transient operation.

Figure 2-5 shows the waveform that would result in this pulsed transient operation example. The Electronic Load starts conduction at the main current level setting (5 amps). When the transient mode is turned on and an external trigger signal is received, the input level starts increasing at a rate determined by the slew rate. When the value specified by the transient level setting (10 amps) is reached, it stays there for the remainder of the time determined by the pulse width setting (1 millisecond). After this time has elapsed, the input level decreases to the main level again at the rate specified by the slew setting and remains there until another trigger is received. Any triggers that occur during the time the transient level is in effect will be ignored.

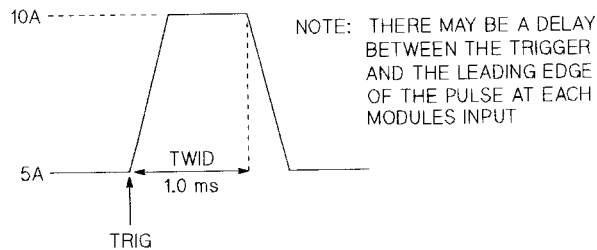

Figure 2-5. Pulsed Transient Operation

Toggled Transient Operation

Toggled transient operation causes the load input to alternate between two predefined levels as in continuous operation except that the transient points are controlled by explicit triggers instead of the internal transient generator. As in pulsed transient operation, the trigger signal can be an external trigger signal, the GPIB **GET** function, the ***TRG** command, or the **TRIG** command. Note that toggled transient operation can only be programmed via the GPIB (**TRAN:TOGG** command); it cannot be programmed at the front panel.

In this example, assume that the CC mode is active, the slew rate is at the factory default setting (maximum rate), an external trigger input signal is connected to the Electronic Load’s rear panel, and the applicable transient operation parameters have been set as follows:

HPSL Command	Description
TRIG:SOUR EXT	Selects the external trigger input source.
TRAN:MODE TOGG	Selects toggled operation.
CURR 5	Sets main current level to 5 amps.
CURR:TLEV 10	Sets transient current level to 10 amps.
TRAN ON	Turns on transient operation.

Figure 2-6 shows the waveform that would result for this toggled transient operation example. Operation is similar to that described for continuous and pulse operation, except that each time a trigger is received the input alternates between the main and transient current levels.

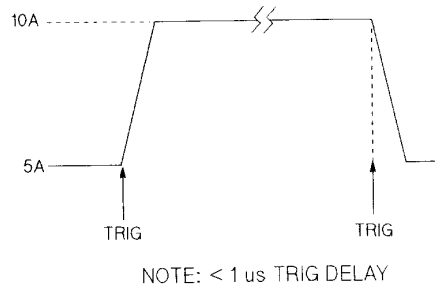

Figure 2-6. Toggled Transient Operation

Triggered Operation

The Electronic Load has various triggering modes to allow synchronization with other test equipment or events. As described previously, triggering can be used for the following applications:

- Triggering a preset level** Transfers all pending preset levels to the actual level. For the presently active mode, the new level appears at the input. For the modes which are not presently active, the preset levels will not take effect at the input until the applicable mode becomes active.
- Triggering a transient pulse** Generates a transient pulse of programmable width when pulsed transient operation is in effect.
- Toggling** Changes the input between the main level and the transient level when toggled transient operation is in effect.

Three triggering methods are available over the GPIB: the **GET** function, the ***TRG** common HPSL command, and the **TRIG** subsystem HPSL command (refer to Programming Reference Guide). The HPSL **TRIG** subsystem allows you to select the **TRIG** command as the trigger source. There is also a **TRIGGER** connector on the rear panel for external trigger inputs. Triggering cannot be done via the front panel.

***TRG** and the **TRIG** command are both synchronous with other commands; that is, the load is not triggered until pending operations are completed. **GET** and external triggers are all asynchronous; that is, the loads are triggered as soon as the trigger signal is received.

The rear-panel **TRIGGER** connector also provides a trigger output signal. This signal is generated synchronously with the trigger signal sent by the load. The trigger output signal can be used to trigger an external device such as an oscilloscope, DVM, or another Electronic Load.

The Electronic Load has a status reporting capability to keep track of trigger operations. Refer to 'Status Reporting' in the *Agilent Electronic Loads Programming Reference Guide*.

Slew Rate And Minimum Transition Time

Slew rate is defined as the change in current or voltage over time. A programmable slew rate allows a controlled transition from one load setting to another to minimize induced voltage drops on inductive power wiring, or to control induced transients on a test device (such as would occur during power supply transient response testing).

In cases where the transition from one setting to another is large, the actual transition time can be calculated by dividing the voltage or current transition by the slew rate. The actual transition time is defined as the time required for the input to change from 10% to 90% or from 90% to 10% of the programmed excursion. In cases where the transition from one setting to another is small, the small signal bandwidth of the load limits the minimum transition time for all programmable slew rates. Because of this limitation, the actual transition time is longer than the expected time based on the slew rate, as shown in Figure 2-7.

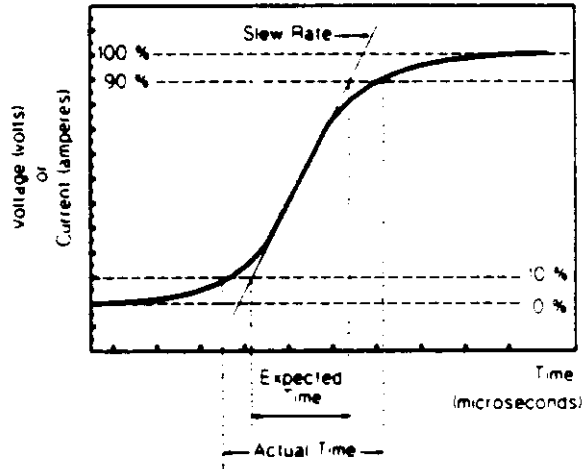

Figure 2-7. Risetime Transition Limitation

Therefore, both minimum transition time and slew rate must be considered when determining the actual transition time. This is shown in Figure 2-8 for the twelve programmable slew rates in current mode operation. The actual transition time will be either the total slew time (transition divided by slew rate), or the minimum transition time, whichever is longer.

In voltage mode, all minimum transition times are based on a low-capacitance current source. These transition times are affected by capacitive loading of the inputs. For example, a capacitance of 2.2 microfarads increases the 85 microsecond minimum transition time (shown in the specifications table) to 110 microseconds. Therefore, no graph is provided for minimum transition time and slew rate in voltage mode operation.

In resistance mode, the low resistance range uses the slew rate that has been programmed for voltage mode. The middle resistance range uses the slew rate that has been programmed for the high current range. The high resistance range uses the slew rate that has been programmed for the low current range.

Input Current, Voltage, and Power Measurement

Each load's input current, voltage, and power can be measured at the front panel (**Meter** key) or via the GPIB (**MEAS** command). With local (front panel) control in effect, pressing **Meter** will continually step the display through voltage and current input values, the computed power value, and various status conditions for the selected channel.

With remote control in effect, a load may be instructed to measure its dc input voltage, current, or power by sending the appropriate query command (e.g. **MEAS:CURR**). The results will be read back when the load is addressed to talk. Voltage and current measurements are performed with approximately 12-bit resolution of full scale ratings. Power is computed from this information.

Short On/Off

A load can simulate a short circuit at its input by turning the load on with full-scale current. The short circuit can be toggled on/off at the front panel (**Short on/off** key) or via the GPIB (**INPUT:SHORT ON|OFF** command). The short on/off change uses the slew rate setting of the active mode and range.

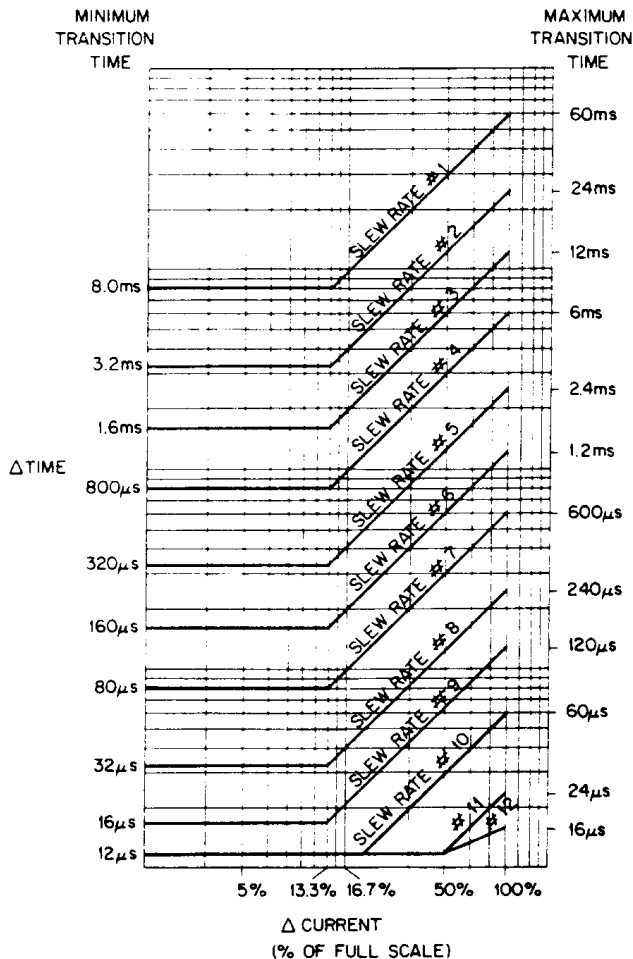

Figure 2-8. Transition Times and Slew Rates

The actual value of the electronic short is dependent on the mode and range that are active when the short is turned on. In CV mode, it is equivalent to programming zero volts. In CC mode, it is equivalent to programming full-scale current for the present CC range. In CR mode, it is equivalent to programming the minimum resistance for the present resistance range.

Note that turning the short on in CV mode may cause the load to draw so much current that the software current limit operates, which may turn the input off.

Turning the short circuit on does not affect the programmed settings, and the input will return to the previously programmed values when the short is turned off.

CAUTION Pressing the Short on/off key with certain user applications may cause damage to the equipment being tested, which may result in personal injury. Contact your Agilent Sales and Service office if you need to have the Short on/off key disabled.

Input On/Off

A load's input can be toggled on/off at the front panel (**Input on/off** key) or via the GPIB (**INPUT ON|OFF** command). The input on/off change does not use the slew rate setting so the input will change at the maximum slew rate.

Turning the input off (zero current) does not affect the programmed settings. The input will return to the previously programmed values when the input is turned on again. Note that the Input On/Off command supersedes the mode commands and Short On/Off command.

Saving and Recalling Settings

The Electronic Load has internal registers in which settings (mode, current, voltage, resistance, slew, transient level, etc.) for various tests can be stored. Saving settings and recalling them later saves programming time.

The present settings are saved in the specified register (0 to 6) at the front panel (**Save** key) or via the GPIB (***SAV** command). All of the settings are saved in the specified location in the load's memory. Settings saved in locations 1 through 6 will be lost when ac line power is cycled. However, the ***SAV 0** command will cause the settings to be stored in non-volatile memory; and, the next time the Electronic Load is turned on, these settings will become the power-on settings.

You can recall the saved settings from the specified register (0 to 6) at the front panel (**Recall** key) or via the GPIB (***RCL** command). All of the parameters that were saved by the ***SAV** command are set to the saved values. At power-on, the Electronic Load automatically executes a ***RCL 0**, which recalls the values saved in nonvolatile memory.

You can recall the factory default settings at the front panel (**Recall** **7**) or via the GPIB (***RST** command).

Reading Remote Programming Errors

Remote programming errors can be read via the GPIB (**SYST:ERR?** query) or at the front panel (**Error** key). The **Err** annunciator indicates when remote programming errors have occurred. The errors are negative numbers grouped into blocks of 100 as follows:

- 1xx Command errors
- 2xx Execution errors
- 3xx Device-specific errors
- 4xx Query errors

The **SYST:ERR?** query (or **Error** key) reads back the errors in the order in which they occurred (the error queue can hold up to 30 entries). Once the error is read back it is removed from the list. A value 0 indicates there is no error; and 0 will be returned when all errors in the list have been read. Pressing the **Error** key displays just the error number. The **SYST:ERR?** query returns the error number and a short description of the error to the computer. Refer to Chapter 6 in the *Agilent Electronic Loads Programming Reference Guide*.

Local programming errors generated by front panel operations are not put into the error list, but are immediately put on the Electronic Load's front panel display; e.g., 'OUT OF RANGE'.

Status Reporting

The Electronic Load incorporates a status reporting capability. Various status conditions within the Electronic Load can be reported using this capability. The user determines which condition will be reported. Chapter 5 of the *Agilent Electronic Loads Programming Reference Guide* describes the status reporting capability in detail. Note that for a Single Input Electronic Load, the same information is available in both the channel status and questionable status registers.

Protection Features

The Electronic Load includes the following protection features:

- Overvoltage
- Overcurrent (hardware and software)
- Overpower (hardware and software)
- Overtemperature
- Reverse Voltage

The appropriate bits in the status registers are set when any of the above protection features are active. Also, the **Prot** annunciator comes on and the front-panel alphanumeric display indicates which conditions have been detected. For example, if an overtemperature (OT) condition has been detected causing the input to be turned off (protection shutdown, PS), the display will indicate "**PS OT**".

Resetting Latched Protection

All of the protection features latch (remain set) when they are tripped, except for the hardware overcurrent and reverse voltage. The latched protection features can be reset via the GPIB (***RST** or **INP:PROT:CLE** commands) or at the front panel (**Prot Clear** key). Of course, the condition that caused the protection feature to trip must be removed or it will trip again as soon as it is reset.



To protect the Electronic Load from possible damage, the input voltage must not exceed the specified maximum input voltage rating . Never apply the ac line voltage to a load's input binding posts.

Overvoltage

The overvoltage protection circuit is set at a predetermined voltage, which cannot be changed. If the overvoltage circuit has tripped, the load will attempt to limit the voltage by drawing current from the DC source. The load limits the value of current drawn such that the resulting power is within the power rating. The overvoltage (OV) and voltage fault (VF) status register bits are set when the OV condition occurs, and will remain set until they are reset as previously described.

An overvoltage condition does not cause the input to be turned off. However, a **Fault** signal output at the rear-panel control connector will indicate when either an overvoltage condition or a reverse voltage condition has occurred. The **Fault** signal is latched true (high TTL level) when the VF bit in the status register goes true. The **Fault** output signal (see Chapter 3) can be used to trip an external circuit breaker or control a relay (e.g., Agilent 59510A Relay Accessory) in order to disconnect the Electronic Load input from the source it is testing when an overvoltage or a reverse voltage condition occurs.

Overcurrent

The Electronic Load includes both hardware and software overcurrent protection features.

Hardware. When operating in the CR or CV mode, it is possible for a load to attempt to sink more current than it is rated for. Under this condition, the load current will be limited by a current limit circuit, which is set at a value slightly above the current rating . It protects both the Electronic Load and the device under test from operating too far beyond specified limits. The hardware current limit circuit does not turn the load's input off. The overcurrent (OC) bit in the status register is set when an OC condition occurs, and is reset when the OC condition is removed.

Software. In addition to the hardware overcurrent protection circuit, the Electronic Load allows the user to define a current protection limit in software which will shut down the input if the limit is exceeded. The protection limit can only be programmed via the GPIB. It is turned on/off using the **CURR:PROT:STATE ON|OFF** command. The software current limit level (in amps) is set using the **CURR:PROT** command. A programmable delay (in seconds) before trip is also provided.

If the software overcurrent limit is exceeded and persists beyond the specified delay time, the input is turned off. Also, for these conditions, the OC and PS (protection shutdown) status register bits are set and will remain set until the OC condition is removed and the bits are reset as previously described.

Overpower

Nominal Power Limit. The nominal power-limit boundary is set by software that monitors the input current and voltage. If the input power exceeds the nominal power limit, the load sets the overpower status bit, which will reset if the overpower condition ceases. If the overpower condition persists for 50 ms, the input turns off, and the OP and PS status bits are both latched on. The input remains off, and the OP and PS status bits remain set, until protection clear occurs. Of course, if the overpower condition is not corrected, the input will turn off again.

Overtemperature

The Electronic Load has an overtemperature (OT) protection circuit that turns off the input if the internal temperature exceeds safe limits. If the OT circuit activates, the OT and PS status register bits are set and will remain set until they are reset. If the OT condition still exists when the reset is executed, the input will remain off. You must wait until the load cools down before you can reset the OT circuit. The fan will continue to operate to cool the unit as quickly as possible.

Reverse Voltage



This feature protects the Electronic Load in case the input dc voltage lines are connected with the wrong polarity. If a reverse voltage (RV) condition is detected, turn off power to the dc source and the load and make the correct connections.

The Electronic Load conducts reverse current when the polarity of the DC source connection is incorrect. The maximum safe reverse current is specified in Table 1-1. The reverse voltage (RV) and voltage fault (VF) bits in the status register are set when reverse voltage is applied. When the reverse voltage is removed the RV bit is cleared. However, the VF bit remains set until it is reset. As previously described, the **Fault** output signal at the control connector tracks the state of the VF bit. The **Fault** signal can be used to control an external relay in order to disconnect the load from the dc source if an RV condition occurs.

Control Connector

The Electronic Load has a 10-pin connector mounted on its rear panel. The connector signals are described in the following paragraphs. See Chapter 3 for connection details.

Remote Sensing

The remote sensing inputs, + **S** and - **S**, can be used in CV or CR modes. By eliminating the effect of the inevitable voltage drop in the load leads, remote sensing provides greater accuracy by allowing the load to regulate directly at the source's output terminals, as well as measure the voltage there.

Monitor Outputs

The **IMON** and **VMON** output signals indicate the input current and voltage. A 0-to-10V signal at the appropriate output indicates the zero-to-full scale input current or voltage. An external DVM or oscilloscope can be connected to monitor the input voltage and current.

External Programming Input

CC and CV modes can be programmed with a signal (ac or dc) connected to the **Ext Prog** input. A 0-to-10V external signal corresponds to the 0-to-full scale input range in CV mode or in CC mode. The external programming signal is combined with the value programmed via the GPIB or the front panel, so that, for example, a programmed value of one-half full scale and a 5-volt external programming input would produce a full-scale value at the input.

Figure 2-9 shows the input waveform that would result from the following setup:

- CC Mode
- High Range
- 60% Full Scale (programmed via GPIB or front panel)
- ± 1 V (2 V pk-pk) 1 kHz external programming signal

The external programming signal (+ and - 1 volt) corresponds to + and - 1/10 full scale values at the input (1 volt external programming input = 1/10 full scale). Therefore, the load's input current values between 50% and 70% of full scale as shown in Figure 2-9.

Fault

The Fault signal becomes active if an overvoltage or reverse voltage occurs at the input, as described in the Protection Features paragraphs.

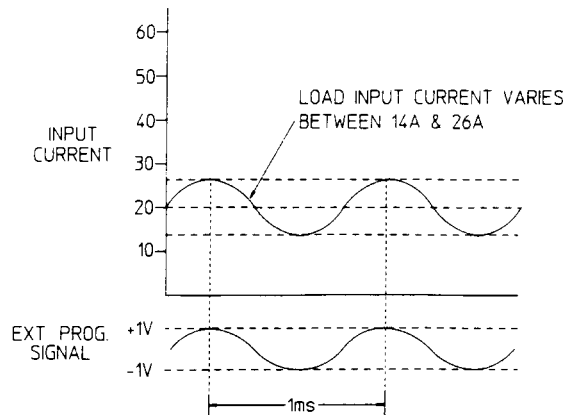

Figure 2-9. External Programming Example

Port On/Off

Port is a general purpose output port that can be used to control an external device such as a relay for power supply test purposes. The output is toggled on and off via the GPIB (**PORT0 ON | OFF** command). It cannot be controlled from the front panel.

The Port output signal is a TTL compatible signal that becomes active (high level) when the **PORT** command is programmed **ON** and becomes inactive (low level) when the **PORT** command is programmed **OFF**.

Installation

Introduction

This chapter discusses how to install and make connections to the rear panel of your Electronic Load. A turn-on checkout procedure as well as application considerations for specific operating modes are also discussed.

Inspection

When you receive your Electronic Load, inspect it for any obvious damage that may have occurred during shipment. If there is damage, notify the carrier immediately and notify the nearest Agilent Sales Office. Warranty information is printed on the inside front cover of this manual.

Save the shipping cartons and packing materials in case the unit must be returned to Agilent Technologies in the future. If you return the unit for service, attach a tag identifying the owner and model number. Also include a brief description of the problem. In addition to this manual, check that the following items have been received with your Electronic Load:

- Power Cord** Your Electronic Load was shipped with a power cord for the type of outlet used at your location. If the appropriate cord was not included, refer to Figure 3-1 for the part number and order option for your type of cord. Contact your nearest Agilent Sales and Service Office to obtain the correct cord. Refer to “*Check Line Voltage*” to check the line voltage selection and fuse type.
- Quick Disconnect Mating Plugs** A 10-pin mating plug for the control connector and a 4-pin mating plug for the trigger connector are shipped with the Electronic Load. These mating plugs are discussed later in this chapter.
- Programming Reference Guide** This guide enables you to use HPSL commands to remotely control your Electronic Load from a controller using the HPSL programming language.
- Change Sheet** Change sheets may be included. Make corrections in the manual accordingly.

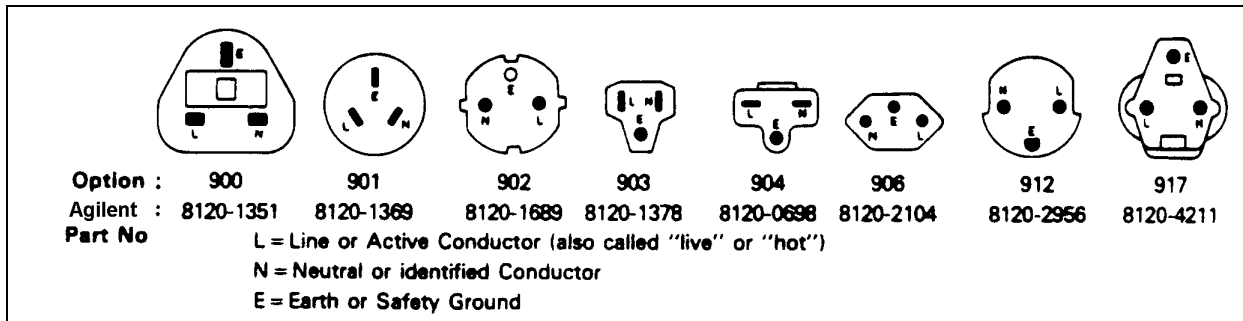

Figure 3-1. Power Cord Configurations

Location and Cooling

Table 1-1 gives the dimensions of the Electronic Load. The cabinet has plastic feet that are shaped to ensure self-alignment when stacked with other Agilent System II cabinets. The feet may be removed for rack mounting. Your Electronic Load must be installed in a location that allows sufficient space at the sides and rear of the unit for adequate air circulation.

The unit can be mounted in a standard 19-inch rack panel or enclosure. Rack mount kits are available as option numbers 908 and 909 (with handles). Installation instructions are included with each rack mounting kit. Instrument support rails are recommended for non-stationary installations.

The unit can operate without loss of performance within the temperature range of 0° to 40°C, and with derated performance from 40° to 55° C. A variable-speed fan cools the unit by drawing in air through the sides and exhausting it out the back. Using Agilent rack mount or slide kits will not impede the flow of air.

Turn-On Checkout

The simplified turn-on checkout procedure discussed in this section verifies that about 90% of the Electronic Load is operating correctly. The Service Manual (Option 910) contains detailed performance and verification tests. Before connecting the power cord and turning on the Electronic Load, check that the line voltage is set correctly and that the sense switch is set to **Local**.

Check Line Voltage

Your Electronic Load can operate with a 100, 120, 220, or 240 Vac input as indicated on the label on the rear panel (see Figure 3-2). Make sure that the factory check mark corresponds to your nominal line voltage. Skip this procedure if the label is correctly marked.

 LINE FUSE RATING		
<input type="checkbox"/> 100V	0.5A	60VA
<input checked="" type="checkbox"/> 120V	250V	MAX
<input type="checkbox"/> 220V	0.25A	50/60
<input type="checkbox"/> 240V	250V	Hz

Figure 3-2. Line Label

1. With the unit off, disconnect the power cord and remove the four cover screws (M5). Use a number 2 Pozidriv.
2. Locate the voltage select switches **S552** and **S553** in the unit (see Figure 3-3).
3. Refer to the drawing on the PC board next to the switches and set the switches to the proper voltage.
4. Replace the cover and mark the correct voltage on the rear panel label.
5. Check the rating of the line fuse and replace it with the correct fuse if necessary (see next step).
6. The line fuse is located below the ac line receptacle (see Figure 3-4). With the power cord removed, use a small screwdriver to extract the fuseholder from under the ac socket. Replace the fuse with the appropriate type as indicated below. These are time-delay fuses.

Line Voltage	Fuse	Agilent Part No.
100/120 Vac	0.5 AT	2110-0803
220/240 Vac	0.25 AT	2110-0817

7. Re-install fuse holder and connect the line cord.

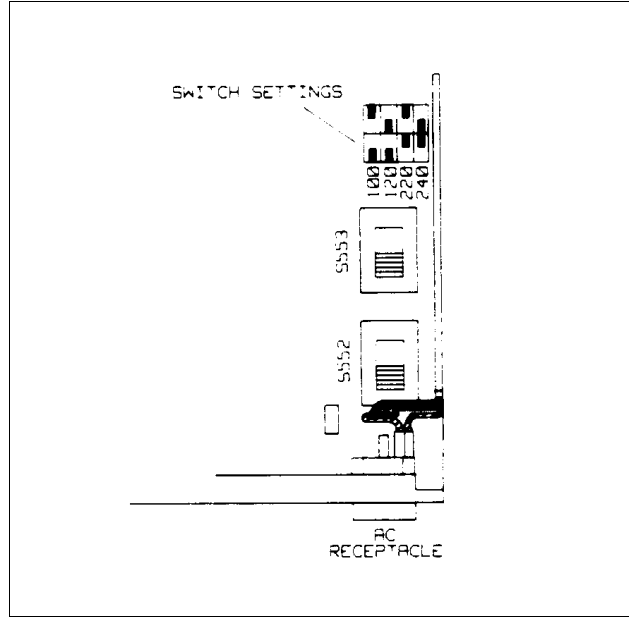

Figure 3-3. Voltage Select Switches

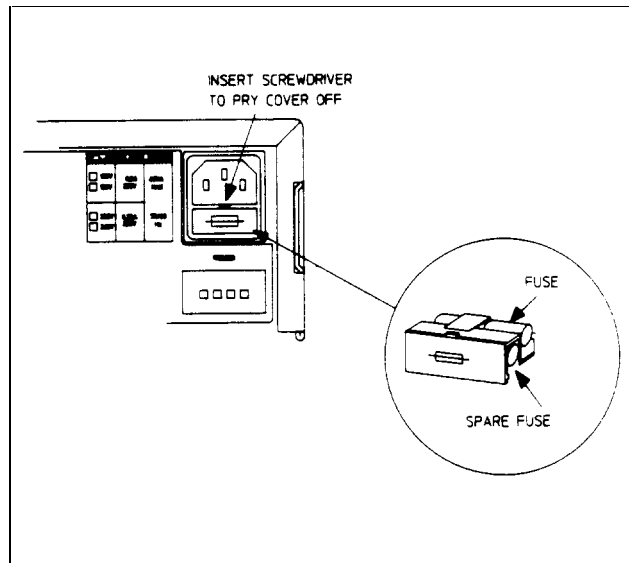

Figure 3-4. Line Fuse

Connect The Power Cord

Your Agilent Electronic Load was shipped with a power cord for the type of outlet used at your location. Connect the power cord to the ac input socket.

WARNING

SHOCK HAZARD The power cord provides a chassis ground through a third conductor. Be certain that your power outlet is of the three-conductor type with the correct pin connected to earth ground (see Figure 3-1).

Turn-On/Selftest

Turn on the Electronic Load using the **LINE** switch on the front panel and observe the display. Immediately after turn-on, the Electronic Load undergoes a selftest that checks the GPIB interface circuitry as well as the input circuitry of the unit. All of the front panel LCD segments are momentarily activated. When selftest completes, the display should appear about the same as the one shown in Figure 3-5 with the **CC** annunciator being on.

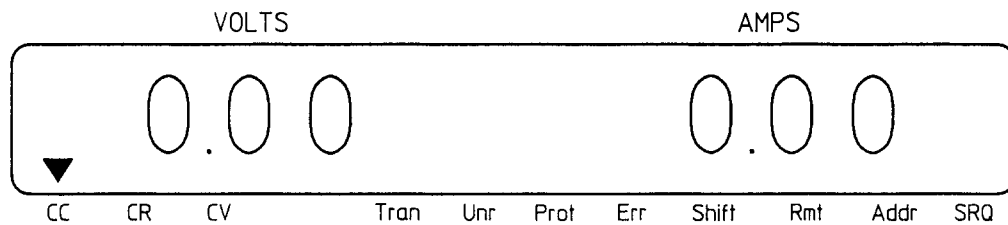

Figure 3-5. Front Panel Display

After the Electronic Load has passed selftest, connect a power supply to the Electronic Load to test the input circuits as described under "Power Test".

If the unit fails any portion of the selftest, one of the following error numbers may briefly appear on the display:

GPIB Errors		Input Errors	
Display	Description	Display	Description
ERROR 4	GPIB failure	ERROR 100	Self test error
ERROR 5	Internal trigger failed	ERROR 101	Secondary RAM failure
		ERROR 102	Secondary ROM failure, power board disconnected or thermistor open
		ERROR 103	Secondary timer trigger failed
		ERROR 104*	Calibration EEPROM failed
		ERROR 105	Main DAC high
		ERROR 106	Main DAC low
		ERROR 107	Transient DAC high
		ERROR 108	Transient DAC low

* Requires calibration.

Another indication that the Electronic Load has failed selftest is if the **ERR** annunciator on the display remains on after selftest completes. If the Electronic Load has failed selftest, return the unit to the nearest Agilent Sales and Service Office for repair.

Power Test

Note The following checkout assumes that the Electronic Load is set to the factory defaults listed in Table 4-6. Refer to Chapter 4 if you need to recall the factory default values.

Use a power supply with the voltage set to 10 V and the current limit set to 10 A to check the input circuits. The settings of the power supply were only selected to agree with the following procedure. You can use different settings, but you must set the Electronic Load accordingly.

1. Connect the power supply to the Electronic Load input binding posts using heavy wires to minimize the voltage drop in the wires.
2. Observe that the front panel of the Electronic Load displays the voltage that the power supply was set to (10 V).
3. Depress the following front panel keys in the indicated order:
CURR **5** **Enter**
4. Observe that the Electronic Load is drawing 5 A and is operating in CC mode. The power supply should be operating in CV mode. The Electronic Load front panel display should appear about the same as the one shown in Figure 3-6.

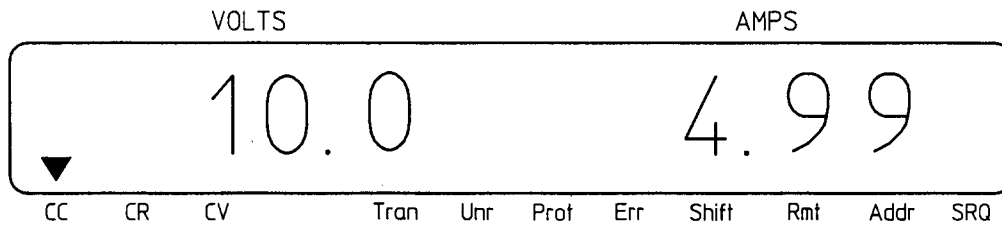

Figure 3-6. Power Test Display

5. Depress the **Meter** key.
6. Observe that the Electronic Load front panel display indicates about 50 W.
7. Turn off the Electronic Load, disconnect the power supply, and continue with the rear panel connections.

Controller Connection

GPIB Connector

The GPIB connector on the rear panel connects the Electronic Load to the controller and to other GPIB devices. A GPIB system can be connected in any configuration (star, linear, or both) as long as:

- The total number of devices including the controller is no more than 15.
- The total length of all cables is no more than 2 meters times the number of devices connected together, up to a maximum of 20 meters.

Note IEEE Std. 488-1978 states that you should exercise caution if an individual cable length exceeds 4 meters.

Do not stack more than three connector blocks together on any GPIB connector. The resultant leverage can exert excessive force on the mounting panels. Make sure that all connectors are fully seated and that the lock screws are firmly hand-tightened. Use a screwdriver only for the removal of the screws.

GPIB Address

The GPIB address of the Electronic Load is factory set to address 5. The GPIB address can only be set using the front panel **Address** and ENTRY keys. Chapter 4 explains how to change the GPIB address.

Rear Panel Connectors and Switches

Figure 3-7 shows the rear panel of the Agilent 6060A Electronic Load.

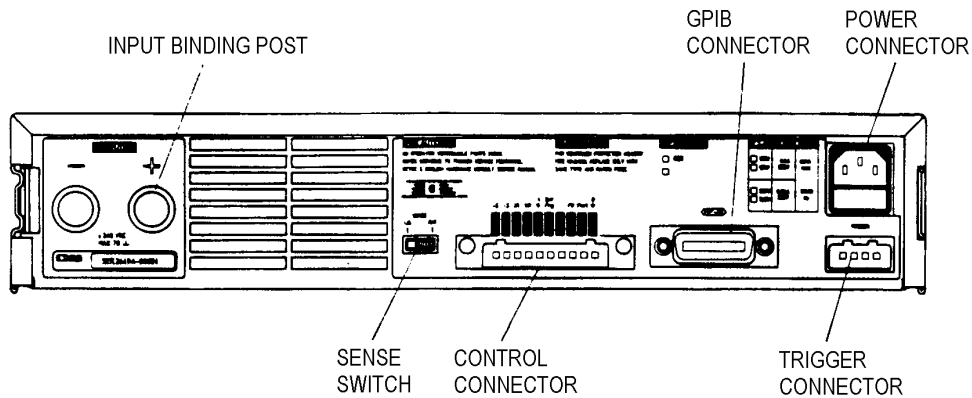

Figure 3-7. Rear Panel

Input Binding Posts

Two screw-down binding posts (+ and -) connect the input wires to the Electronic Load (see Figure 3-8). Connections are made as follows:

1. Strip back the wire insulation as indicated:

Wire Size	Strip back:
AWG 4	16 mm
AWG 6 or 8	13 mm
AWG 10 or smaller	10 mm

AWG 4 is the maximum wire size. AWG 6 or 8, is the recommended wire. If you are connecting more than one wire on each post, solder or twist the wires to ensure a good contact on each wire when the adjustment knob is tightened.

2. Insert the wire into the binding post. Do not extend the wire beyond the bottom of the binding post.

- Hand tighten the adjustment knob to secure the wire in the binding post. If you are using a slotted screwdriver, tighten the knob to 8 in.-lbf for a secure connection.

Installation for the optional front panel binding posts is the same as for the rear terminal binding posts.

CAUTION

Do not use lubricants or contact cleaners on the binding posts. Certain chemical agents can damage the LEXAN material of the binding post, causing the part to fail.

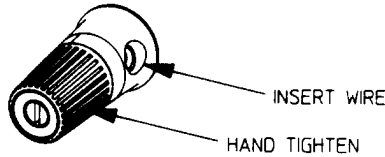

NOTES:

- WIRE SIZE: AWG 4 MAX
- STRIP BACK INSULATION (13mm FOR AWG 6 OR 8)
- INSERT WIRES IN HOLE IN BINDING POSTS.
- TIGHTEN TO 8 in.-lbf.
- OBSERVE PROPER POLARITY WHEN CONNECTING LEADS TO SOURCE.

Figure 3-8. Input Binding Post

Control Connector

A ten-pin terminal block (TB301) connector and a quick-disconnect mating plug (RTB1) are provided for connecting remote sense leads, external V/I monitors, an external programming input, and external control lines (see Figure 3-9). You must remove the safety cover before you can disconnect mating plug RTB1.

Consistent with good engineering practice, all leads connected to the control connector should be twisted and shielded to maintain the instrument's specified performance.

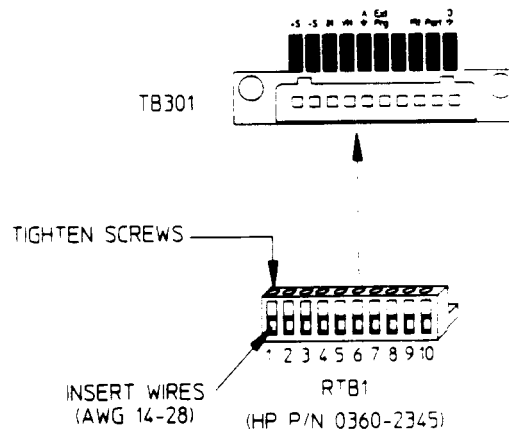

Figure 3-9. Control Connector

+S and -S	Used to connect the remote sense leads to the power source. Pin 1 connects the + S signal and pin 2 connects the - S signal.
IM and VM (pins 3 and 4)	Used to monitor the Electronic Load's input current and voltage. A 0 V-to-10 V signal at the appropriate pin indicates the zero-to-full scale current or voltage. Pin 3 monitors current (IM); pin 4 monitors voltage (VM).
Common (pin 5)	Provides the common connection for the IM , VM , and external programming (Ext Prg) signals. This common point is floating from ground at the potential of the - INPUT terminal.
Ext Prg (pin 6)	Connects an external programming input. The CC and CV mode can be programmed with a 0 V-to-10 V signal (ac or dc). This signal can act alone or can be summed with values programmed over the GPIB. Thus, it is possible to have an ac signal applied at pin 6 upon a programmed dc level.
Pin 7	Not used.
Flt (pin 8)	A TTL-compatible output signal that becomes active (high level) when an overvoltage or a reverse voltage condition occurs. This signal powers up in the inactive (low-level) state.
Port (pin 9)	A TTL-compatible output signal that becomes active (high level) when the PORT0 command is programmed ON . This signal can be used to control an external device such as a relay for shorting the Electronic Load's input terminals or as a general purpose digital output port. This signal powers up in the inactive (low-level) state.
Common (pin 10)	Provides the common connection for the Flt and Port signals.

Replace the mating plug in the connector after you have finished making all wire connections. Replace the safety cover.

Trigger Connector

A four-pin connector block (TB201) connector and a quick-disconnect mating plug (RTB2) are provided for input and output trigger signals (see Figure 3-10).

Consistent with good engineering practice, all leads connected to the trigger connector should be twisted and shielded to maintain the instrument's specified performance.

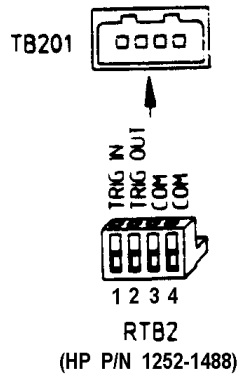

Figure 3-10. Trigger Connector

- TRIG IN (pin 1)** A TTL-compatible input that responds to low-level external trigger signals. A trigger applied to this input can be used to change settings (voltage, current, resistance, etc.), toggle between settings in transient-toggle mode, or generate a pulse in transient-pulse mode.
- TRIG OUT (pin 2)** A TTL-compatible output signal that becomes active (low level) whenever the load is triggered with a GPIB command or **TRIG IN** signal. This signal can be used to trigger external equipment such as oscilloscopes, digitizers, or another load.
- Common (pins 3 and 4)** Provides the common connection for the trigger signals.

Sense Switch

Unless you are using remote sensing, make sure that the sense switch is set to **Local**. Remote sensing is used in certain applications to achieve greater accuracy (refer to "*Remote Sense Connections*" for more information).

Note If the sense switch is set to remote operation without having sense leads connected to the sense inputs, the unit will continue to work in CC mode, but the input will turn off in CV and CR mode. Voltage readback will not work in any mode.

Application Connections

Wiring Considerations

WARNING

FIRE HAZARD To satisfy safety requirements, load wires must be heavy enough not to overheat while carrying the short-circuit output current of the device connected to the Electronic Load. Refer to Table 3-1 for the ampere capacity of various stranded wire sizes.

Input connections are made to the + and - binding posts on the panel. (Input connections can also be made to the optional front panel binding posts). A major consideration in making input connections is the wire size. The minimum wire size required to prevent overheating may not be large enough to maintain good regulation. It is recommended that stranded, copper wires be used. The wires should be large enough to limit the voltage drop to no more than 0.5 V per lead. Table 3-2 gives the maximum load lead length to limit the voltage drop to the specified limit.

Local Sense Connections

Figure 3-11 illustrates a typical setup with Electronic Load connected for constant current or constant resistance operation. Local sensing is used in applications where lead lengths are relatively short, or where load regulation is not critical. The sense switch must be set to **LCL**. Load leads should be bundled or tie-wrapped together to minimize inductance.

Remote Sense Connections

Figure 3-12 illustrates a typical setup with Electronic Load connected for remote sense operation. The remote sense terminals of Electronic Load are connected to the output of the power supply. Remote sensing compensates for the voltage drop in applications that require long lead lengths. It is only useful when Electronic Load is operating in CV or CR mode, or when using voltage readback. The sense switch must be set to **RMT**. Load leads should be bundled or tie wrapped together to minimize inductance.

Table 3-1. Stranded Copper Wire Ampere Capacity

Wire Size AWG	Cross Section Area in mm ²	Ampacity	Notes:
22	0.75	5.0	1. Ratings for AWG-sized wires derived from MIL-W-5088B. Ratings for metric-sized wires derived from IEC Publication 33-51.
20		8.33	
18	1	10	2. Ampacity of aluminum wire is approximately 84% of that listed for copper wire.
16		15.4	
14	1.5	13.5	3. When two or more wires are bundled together, ampacity for each wire must be reduced to the following percentages:
12		19.4	
10	2.5	16	2 conductors 94%
8		31.2	
6	4	25	3 conductors 89%
4		40	
6	6	32	4 conductors 83%
4		55	
6	10	40	5 conductors 76%
4		75	
6	10	63	4. Maximum temperatures: Ambient = 50° C
4		100	
4		135	Conductor = 105° C

Parallel Connections

Figure 3-13 illustrates how Electronic Loads can be paralleled for increased power dissipation. Up to six Electronic Loads can be directly paralleled in CC or CR mode. Units *cannot* be paralleled in CV mode.

Each Electronic Load will dissipate the power it has been programmed for. For example, if two Electronic Loads are connected in parallel, with Electronic Load number 1 programmed for 10 A and module number 2 programmed for 20 A, the total current drawn from the source is 30 A.

In Figure 3-13, all lead connections are terminated at the source. Each Electronic Load is connected to the source using separate wires. Using the source as the current distribution point allows larger wires to be used for each Electronic Load connection and also reduces the common impedance inherent in daisy-chained configurations.

Figure 3-13 shows one method of triggering Electronic Loads that are connected in parallel. The **TRIG OUT** signal of Electronic Load number 1 is connected to the **TRIG IN** input of Electronic Load number 2. Additional Electronic Loads can be daisy chained to Electronic Load number 2 in the same manner. Once the new settings of the Electronic Loads have been programmed, one trigger signal can be used to simultaneously set all of the Electronic Loads to their new settings.

Zero-Volt Loading Connections

As shown in Figure 3-14, the Electronic Load can be connected in series with a voltage source or auxiliary power supply greater than 3 V so that the Electronic Load can test devices at its full current capacity down to a zero-volt level. Remote sensing is recommended for improved load regulation and when turning the short on.

Table 3-2. Maximum Wire Lengths to Limit Voltage Drops

Wire Size		Resistivity		Maximum Length in Meters (Feet) to Limit Voltage Drop to 0.5 V or Less						
AWG	Cross Section Area in mm ²	Ω/kft	Ω/km	5 A	10 A	20 A	30 A	40 A	50 A	60 A
22	0.5	16.15	40.1	(6)	(3)	(1.5)	(1)	(0.77)	(0.62)	(0.52)
				2.5	1.2	0.6	0.4	0.31	0.25	0.21
20	0.75	10.16	26.7	(9.5)	(4.5)	(2)	(1.5)	(1.23)	(0.98)	(0.82)
				3.7	1.9	0.9	0.6	0.47	0.37	0.31
18	1	6.388	20.0	(15.5)	(7.5)	(3.5)	(2.5)	(2.0)	(1.57)	(1.30)
				5.0	2.5	1.3	0.8	0.63	0.50	0.42
16	1.5	4.018	13.7	(24.5)	(12)	(6)	(4)	(3.1)	(2.49)	(2.07)
				7.3	3.6	1.8	1.2	0.91	0.73	0.61
14	2.5	2.526	8.21	(39.5)	(19.5)	(9.5)	(6.5)	(4.9)	(3.46)	(3.30)
				12.2	6.1	3.0	2.0	1.52	1.22	1.01
12	4	1.589	5.09	(62.5)	(31)	(15.5)	(10.5)	(7.9)	(6.29)	(5.24)
				19.6	9.8	4.9	3.3	2.46	1.96	1.64
10	6	0.9994	3.39	(100)	(50)	(25)	(17)	(12.5)	(10.00)	(8.34)
				29	14.7	7.4	4.9	3.69	2.95	2.96
8	10	0.6285	1.95	(159)	(79)	(39.5)	(27)	(19.9)	(15.91)	(13.25)
				51	25	12.8	8.5	6.41	5.13	4.27
6	16	0.3953	1.24	(252)	(126)	(63)	(40)	(31.6)	(25.30)	(21.07)
				80	40	20	13.4	10.08	8.06	6.72
4		0.2486		(402)	(201)	(100)	(68)	(50.37)	(40.23)	(33.51)

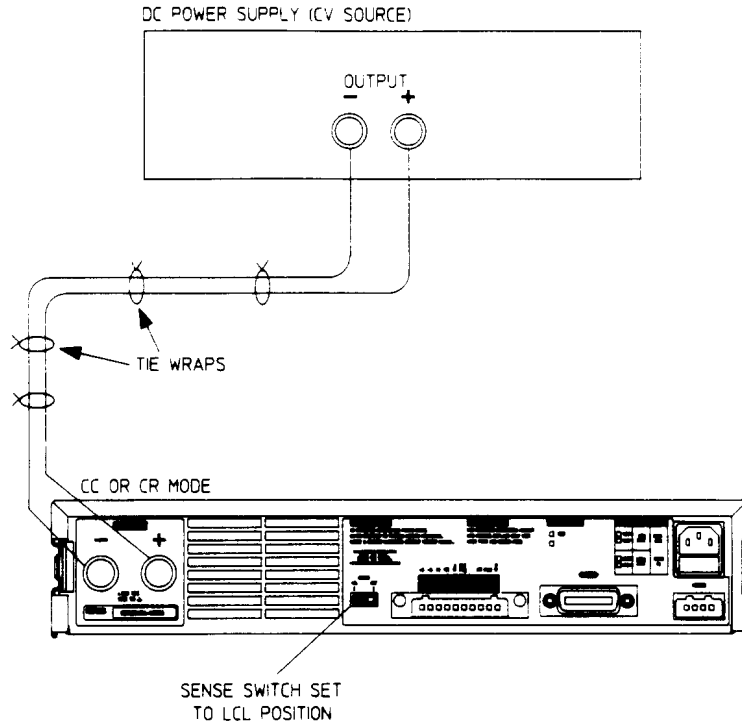

Figure 3-11. Local Sensing

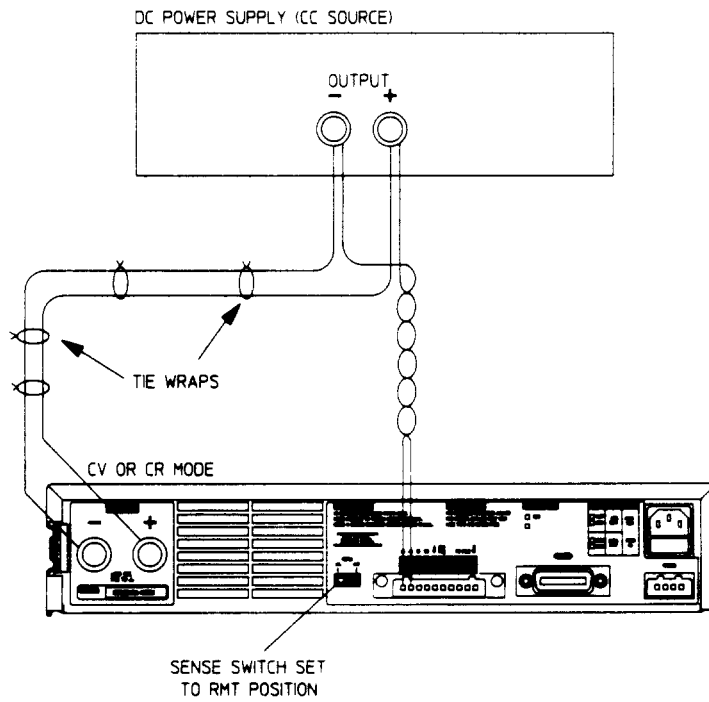

Figure 3-12. Remote Sensing

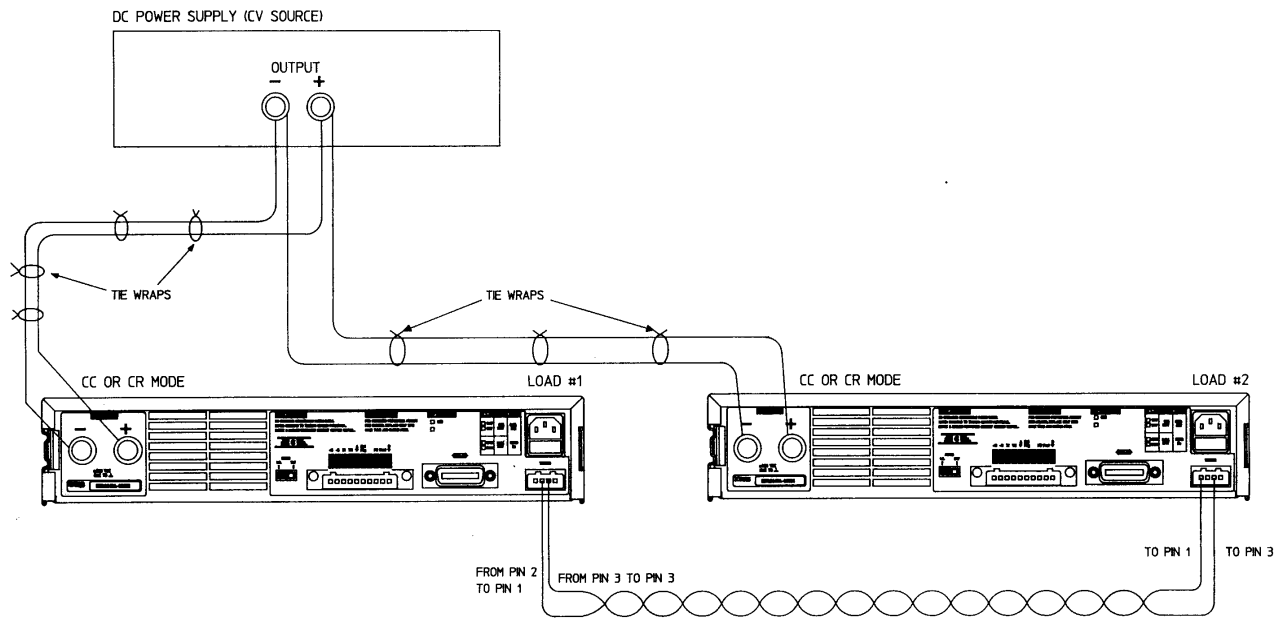

Figure 3-13. Parallel Operation

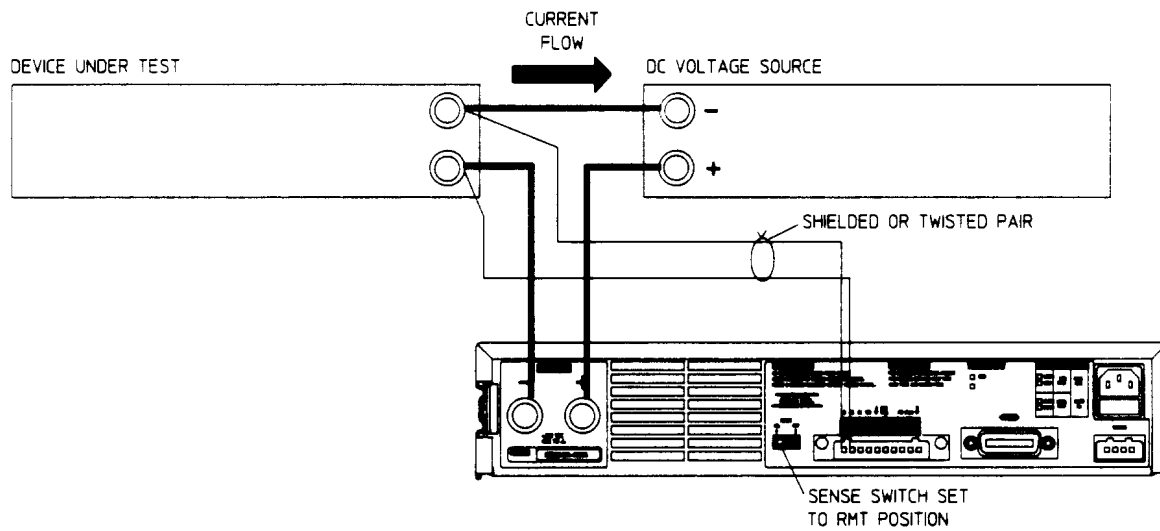

Figure 3-14. Zero-Volt Loading

Local Operation

Introduction

The “Operation Overview” chapter introduced you to the Electronic Load’s features and capabilities and briefly described how to control the unit locally from the front panel and remotely with a computer via the GPIB. This chapter describes in greater detail how to operate the Electronic Load from the front panel. The following discussions are provided:

- Front Panel Controls and Indicators
- Local Control Overview
- Using the FUNCTION Keys
- Using the SYSTEM Keys

The Electronic Load can be programmed locally using the controls and indicators on the front panel. As shown in Figure 4-1, the front panel’s controls and indicators include a 12-segment LCD display and a keypad having three groups of keys (SYSTEM, FUNCTION, and ENTRY). Table 4-1 gives a brief description of each control and indicator.

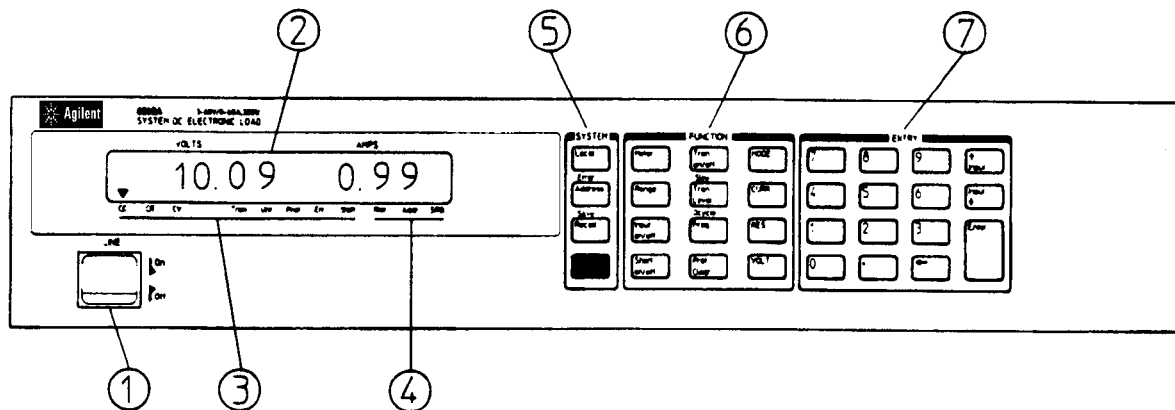

Figure 4-1. Front Panel

Table 4-1. Controls and Indicators

Item	Description
1 Line Switch	Turns the ac power on and off.
2 LCD Display	Normally displays the actual voltage and current at that input (e.g. 10.09 and 0.99, respectively). When programmed from the front panel, the function being programmed is displayed along with the value (e.g. CURR 1.000).

Table 4-1. Controls and Indicators (continued)

Item	Description
<p>3 Electronic Load Status Annunciators</p>	<p>CC-Indicates the Electronic Load is in the constant current (CC) mode. Note that Figure 4-1 shows the Electronic Load is in the CC mode (CC annunciator is on).</p> <p>CR-Indicates the Electronic Load is in the constant resistance (CR) mode.</p> <p>CV-Indicates the Electronic Load is in the constant voltage (CV) mode.</p> <p>Tran-Indicates that transient operation is enabled.</p> <p>Unr-Indicates that the Electronic Load is unregulated (applies only in the CC mode and in the middle and high ranges of the CR mode).</p> <p>Prot-Indicates when any protection features (CC, OV, OP, OT, etc.) are active.</p> <p>Err-Indicates that remote programming error(s) have occurred.</p> <p>Shift-Indicates that the shift key, bottom key (blue) in SYSTEM group, was pressed.</p>
<p>4 GPIB Status Annunciators</p>	<p>Rmt-Indicates that the Electronic Load is in the GPIB remote state. In the remote state, the only front panel key that will function is the Local key.</p> <p>Addr-Indicates that the Electronic Load is addressed to talk or to listen over the GPIB.</p> <p>SRQ-Indicates that the Electronic Load is requesting service over the GPIB; i.e., the service request line (SRQ) is active.</p>
<p>5 SYSTEM Keys</p>	<p>Local - Returns the Electronic Load from remote (computer) control to local (front panel) control.</p> <p>Address - Displays the Electronic Load's GPIB address. You can change the address using the numeric entry keys. You cannot query or change the address remotely (over the GPIB).</p> <p>Error (shifted address key) - Displays error codes that resulted from remote programming.</p> <p>Recall - Used in conjunction with the ENTRY keys to recall the saved settings from the specified location (Recall 0 through Recall 7). Recall 7 recalls the factory default settings.</p> <p>Save (shifted Recall key) - Used in conjunction with the ENTRY keys to save all of the present settings (mode, current, resistance, voltage, etc.) in the specified register (SAVE 0 thru SAVE 6). The settings in locations 1 thru 6 will be lost when ac power is cycled. However, SAVE 0 will cause the settings to be stored in non-volatile memory; and, the next time the Electronic Load is turned on, these settings will become the power on settings.</p> <p>Shift (blue shift Key) - Activates shifted key functions (e.g., Error, Save, Slew, etc.). The Shift annunciator goes on when this key is pressed.</p>

Table 4-1. Controls and Indicators (continued)

Item	Description
<p>6 FUNCTION Keys</p>	<p>Meter - Returns the display to the metering function selected, the display will show the measured input voltage and current, the computed input power, or certain status conditions (e.g. INPUT SHORT ON, OC, etc.). Press the Meter key to continually step through the displays.</p> <p>Range - Displays the setting for current (C:RNG) or resistance (R:RNG), depending upon which function is selected. The settings can be changed using the ENTRY keys.</p> <p>Input on/off - Toggles the input on and off. Input Off disables the Electronic Load. Input On enables the input and returns the Electronic Load to the original settings.</p> <p>Short on/off - Toggles the short circuit mode on and off. Short On applies a short circuit across the Electronic Load input. Short Off removes the short circuit and returns the Electronic Load to the original settings.</p> <p>Tran On/Off - Toggles transient operation on and off. The Tran annunciator is on while transient operation is on. Transient operation causes the Electronic Load input to periodically switch between two levels.</p> <p>Tran Level - Displays the transient level for current (C:TLV), resistance (R:TLV), or voltage (V:TLV) depending upon which function is selected. This level can be changed using the ENTRY keys. The input alternates between the transient level (TLV) and the main level of the active mode (CURR, RES, or VOLT) when transient operation is turned on.</p> <p>Slew - (shifted Tran Level key)-Displays the slew setting for current (C:SLW) or voltage (V:SLW) depending upon which function is selected. The settings can be changed using the ENTRY keys. The slew settings determine the rates at which new programmed values will change. Note that resistance changes use the voltage or current slew rate settings depending upon the resistance range.</p> <p>FREQ - Displays the frequency setting of the transient generator (e.g. FREQ 1000). The setting can be changed using the ENTRY keys. The Freq setting determines the frequency in continuous transient operation.</p> <p>Dcycle (shifted Freq key) - Displays the duty cycle of the transient generator (e.g. DCYCLE 50.0). The setting can be changed using the ENTRY keys. The Dcycle setting determines the TLEV portion (percentage) of the duty cycle in continuous transient operation.</p> <p>Prot Clear Clears the latching-type protection circuits: overvoltage, overpower, overtemperature, and overcurrent (user programmed).</p> <p>MODE - Displays the active mode: constant current (MODE CURR), constant resistance (MODE RES), or constant voltage (MODE VOLT). The active mode can be changed using the CURR, RES, or VOLT key followed by the Enter key.</p> <p>CURR - Displays the main current setting (e.g. CURR 3.275). This setting can be changed using the ENTRY keys. The CURR key also selects the CC mode (MODE CURR) in conjunction with the MODE and Enter keys.</p>

Table 4-1. Controls and Indicators (continued)

Item	Description
6 FUNCTION Keys (continued)	<p>RES - Displays the resistance setting. (e.g. RES 1000). This setting can be changed using the ENTRY keys. The RES key also selects the CR mode (MODE RES) in conjunction with the MODE and Enter keys.</p> <p>VOLT - Displays the voltage setting (e.g. VOLT 5.567). This setting can be changed using the ENTRY keys. The VOLT key also selects the CV mode (MODE VOLT) in conjunction with the MODE and Enter keys.</p>
7 ENTRY Keys	<p>0 to 9 and . Set the value of the specified function (e.g. CURR 2.525, RES 1000, VOLT 7.000, etc.).</p> <p>← (backspace) - Erases the previous keystroke in order to make corrections before entering a new setting.</p> <p>Enter - Enters the values on the display for the specified function (or selects the mode of operation), and returns the front panel to the metering mode.</p> <p>Input ▲ and Input ▼ - These keys simulate front panel control knobs. They can be used to change the main level or the transient level of the function shown on the display. The new values are entered automatically (Enter key is not used) and they take effect as soon as they are displayed. You can also use these keys to change the actual input level when the display is monitoring the input voltage/current or the computed power. Note that these keys have no effect on range, slew, frequency, etc.</p>

Local Control Overview

In order to use the front panel keys to control the Electronic Load, local control must be in effect. Local control is in effect immediately after power is applied. With local control in effect (**Rmt** annunciator off), the SYSTEM, FUNCTION, and ENTRY keys can be used to program the Electronic Load. The power-on "wake-up" settings for all of the Electronic Load's functions can be the factory default values or other user selected values as described later in this chapter.

In the remote state (front panel **Rmt** annunciator on), the front panel keys will have no effect; only the GPIB controller can program the Electronic Load. You can still use the front panel display to view the input voltage and current readings while the remote state is in effect.

You can return the Electronic Load to local control from remote control by pressing the Local key, provided that the local lockout command has not been received from the GPIB controller.

With local control in effect, you can use the front panel display to view the input voltage/current values and the computed power value as well as certain fault and status conditions that may be present. This is referred to as the metering mode.

The display can also be used to view programmed settings when certain SYSTEM and FUNCTION keys are pressed. This is referred to as the programming mode.

You can return the display to the metering mode from the programming mode by pressing **Meter**. Continually pressing the Meter key will cause the display to step through the following:

- "INPUT OFF" (if active)
- "SHORT ON"
- Volts/Amps input metering, for example, "9.99 0.99"
- Computed power value, for example "9.9 WATTS"
- Protection Features (if any are active):
 - "VF"-voltage fault
 - "OV"-overvoltage
 - "RV"-reverse voltage
 - "PS"-protection shutdown
 - "OC"-overcurrent
 - "OP"-overpower
 - "OT"-overtemperature

If the display is metering the input voltage/current or the computed power, you can use the Input ENTRY keys to increase or decrease the actual input. These keys simulate front panel control knobs. Pressing **Input ▲** will cause the main level (current, resistance, or voltage) of the active mode to increase, while pressing **Input ▼** will cause the main level to decrease. You can continually press an Input key to speed up the changes. In the CC and CR modes, the total amount of change is determined by the selected range.

The protection features are described briefly in *Chapter 2- Operation Overview* in this guide. When programming the Electronic Load remotely, you can use the Electronic Load's status reporting capability to check the state of the protection features. Refer to *Chapter 5 - Status Reporting in the Agilent Electronic Load Family Programming Reference Guide*.

Note If the input voltage exceeds the maximum measurement capability of the Electronic Load, an overload (OVLD) condition will occur. This will cause the front panel display to change from indicating the volts/amps values (or the computed power value) to indicating "OVLD".

Using The Function Keys

Most of an Electronic Load's functions can be programmed using these keys. Figure 4-2 is a flow chart that shows a recommended programming sequence. Note that the sequence includes turning the input off before you program any values. This is a good practice because it insures that there is no input current while you are setting up your test program.

Programming is accomplished by selecting a mode of operation (CC, CR, or CV) and setting the desired values for range (if applicable), the main operating level, and the slew rate. If transient operation is desired, set the applicable transient level, make the desired frequency and duty cycle settings, and turn transient operation on. The settings you make will take effect at the input as soon as you turn the input on.

Some programming examples are given in subsequent paragraphs . If you program a value outside the valid range, it will be ignored and the display will read "OUT OF RANGE".

Note In the programming examples that follow, it is assumed that a dc source is connected to the Electronic Load's INPUT binding posts.

Turning the Input On/Off

The input can be toggled on and off by pressing **Input on/off**. When the input is turned off, the message "INPUT OFF" will be displayed. The input on/off change does not use any slew setting, so the input will change at the maximum rate. Turning the input off does not change the programmed settings.

Turning the input on again restores the input to the programmed values and returns the display to the metering mode.

Note

The CC, CR, and CV values described in subsequent paragraphs can be programmed whether or not the associated mode is active. When a mode is selected, all of the associated values will take effect at the input provided that the input is turned on.

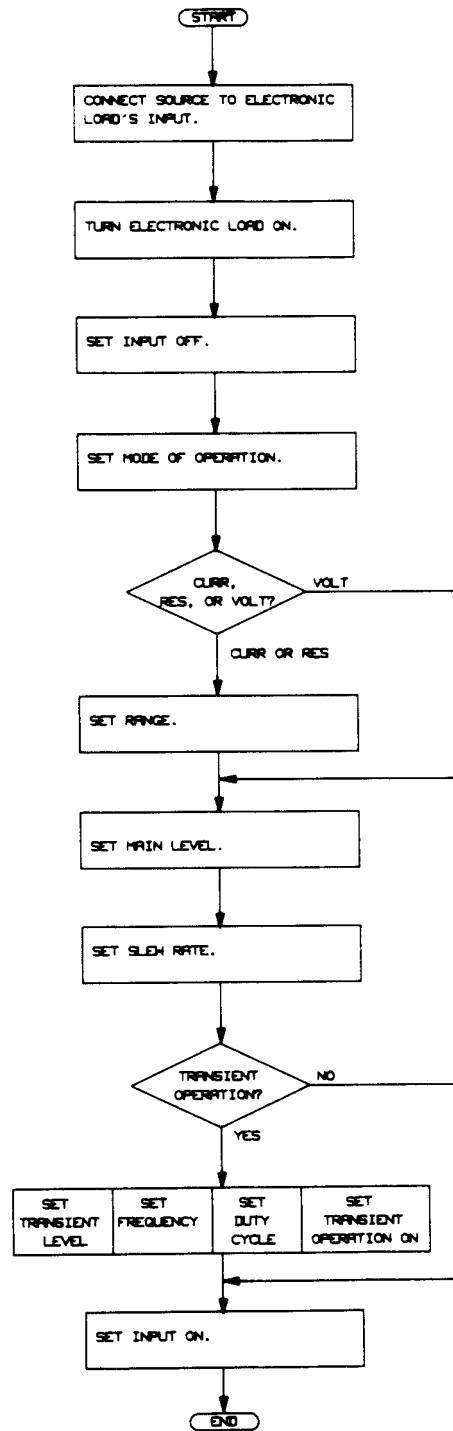

Figure 4-2. Recommended Programming Sequence

Setting the Mode of Operation

The present (active) mode of operation is indicated by the appropriate annunciator being on (e.g. **CC**). The active mode can also be viewed on the display by pressing **MODE**.

For example, "MODE CURR" indicates that the **CC** mode is active. You can change the mode to **CR** or **CV** by pressing the applicable key. To change the mode of operation from **CC** to **CR**, first press **RES** which changes the display to "MODE RES". Now, to activate the **CR** mode, press **Enter**. As soon as the Enter key is pressed, the **CR** annunciator goes on, the resistance settings affect the input (provided that the input is turned on), and the display returns to the metering mode.

Note The Range, Tran Level, and Slew (shifted Tran Level) keys are common to the **CC**, **CR**, and **CV** functions. These keys become associated with a particular function when you press the applicable function key (**CURR**, **RES**, or **VOLT**). If you do not select a function, they are associated with the function that is presently active.

Setting CC Values

The **CC** values are programmed by pressing the applicable **FUNCTION** keys and setting the desired values using the **ENTRY** keys. The display identifies the selected function; for example, **C: SLW** identifies current slew rate.

Ranges

The **CC** values can be programmed in either a low range or a high range. The valid **CC** values that can be programmed are listed in Table 4-2 along with the applicable front panel key and display identifier. Note that all current levels are programmed in amps and current slew rates are programmed in amps/microsecond.

Table 4-2. CC Programming Ranges

Function	Key	Display	Range of Values	
Set Range	Range	"C:RNG value"	6060B	6063B
Low A Range			≥ 0 and ≤ 6	≥ 0 and ≤ 1
High Range			> 6 and ≤ 60	> 1 and ≤ 10
Set Main Level	CURR	"CURR value"		
Low Range			0.0000 to 6.0000	0.0000 to 1.0000
High Range			0.000 to 60.000	0.000 to 10.000
Set Slew Rate		"C:SLW value"	(see Note 1)	
Low Range	Slew (shifted)		0.00010 to 0.5000 (A/ μ s)	0.000017 to 0.083 (A/ μ s)
High Range			0.0010 to 5.000 (A/ μ s)	0.00017 to 0.83 (A/ μ s)
Set Transient Level	Tran Level	"C:TLV value"	(see Note 2)	
Low Range			0.0000 to 6.0000	0.0000 to 1.0000
High Range			0.000 to 60.000	0.000 to 10.000

Notes:

- There are 12 discrete steps within a **CC** slew range (low or high). The 12 slew rate steps for each range are listed in Table 1-1. Any slew rate can be programmed (there are no upper and lower limits that would cause an error). The Electronic Load automatically selects one of the 12 slew rates that is closest to the programmed value. See *Chapter 2 Operation Overview* in this manual.
- The transient current level is meaningful only if transient operation is turned on. The transient current level must be set to a higher level than the main current level. See *Transient Operation* later in this Chapter.

Changing the programming range can cause the present CC settings (main level, transient level, and slew rate) to be automatically adjusted to fit within the new range. For example, assume that you are programming the Agilent 6060B 300 Watt Electronic Load, the present range is 0 to 60A "C:RNG 60.000", and the present CC settings are:

"CURR 10.000" - main level is 10 A
"C:TLV 12.000" - transient level is 12 A
"C:SLW 5.0000" - slew rate is 5 A/ μ s

If you now select the 0 to 6 A range "C:RNG 6.0000", the settings will automatically change to the following:

"CURR 6.0000" - main level is 6 A
"C:TLV 6.0000" - transient level is 6 A
"C:SLW .50000" - slew rate is 0.5 A/ μ s

Examples

The following examples illustrate how to set CC values. Before you do these examples, press **Recall** **7** **Enter** to set the CC values to their factory default states (see Table 4-6).

1. Set Range
 - a. Press **CURR** to select the CC function. Now press **Range** to determine the range setting. Note that the display indicates "C:RNG " and the maximum high range CC value. This means that the high range is selected.
 - b. Select the low range by pressing **1** **Enter**
 - c. Press **Range** and check that the display indicates "C:RNG" and the maximum low range CC value. This means that the low range is selected.
2. Set Main Level
 - a. Press **CURR** and note that the display indicates "CURR" and the minimum low range CC value.
 - b. Set the main current level to 0.5 amps by pressing **CURR** **.** **5** **Enter** .
 - c. Press **CURR** again and check that the display indicates "CURR 0.5000".

Note that you can use the **Input** ENTRY keys to increment (**▲**) or decrement (**▼**) the main level CURR setting. You can see the CURR setting being incremented or decremented one step at a time each time you press the applicable Input key. The values are entered automatically (you don't press the Enter key). Remember that if the CC mode is active, the incremented or decremented values will immediately change the actual input.

3. Set Slew Rate
 - a. First press the **Shift** (blue shift key) and note that the **Shift** annunciator goes on. Now press **Slew** (shifted Tran Level key) to determine the slew setting. Note that the display indicates "C:SLW" and the maximum slew rate setting for the low range.
 - b. Set the slew rate to 0.0025 A/ μ s by pressing **.** **0** **0** **2** **5** **Enter** .
 - c. Press **Shift** and **Slew** again and check that the display indicates "C:SLW 0.0025" (or the closest slew rate step to this value depending upon the model being programmed).
4. Set Transient Level - The transient current level "C:TLV" is meaningful only if transient operation (described later) is turned on.

Note: Remember that you set the main current level to 0.5 amps in step 2. In CC mode, the transient level must be set to a higher level than the main level.

- a. Set the transient level to 1 amp by pressing **Tran Level** **1** **Enter**

- b. Press **Tran Level** again and note that the display indicates "C:TLV 1.0000". Note that you can use the Input ENTRY keys to increment and decrement the transient current level. Operation is similar to that described above for the main current level.

Setting CR Values

The CR values are programmed by pressing the applicable FUNCTION keys and then setting the desired value using the ENTRY keys. The display identifies the selected function; for example, R:RNG identifies resistance range. See Appendix A for considerations regarding high-resistance applications.

Ranges

The resistance values can be programmed in a low, middle, or high range. The valid CR values that can be programmed are listed in Table 4-3 along with the applicable front panel key and display identifier. Note that all resistance levels are programmed in ohms and the slew rate is in amps/microsecond or volts/microsecond depending upon the resistance range.

Table 4-3. CR Programming Ranges

Function	Key	Display	Range of Values	
			6060B	6063B
Set Range	Range	"R:RNG value"		
Low range			≥ 0 or ≤ 1	≥ 0 and ≤ 24
Middle range			> 1 or ≤ 1000	> 24 or ≤ 24000
High range			> 1000 or ≤ 10000	> 24000 or ≤ 240000
Set Main Level	RES	"RES value"		(see Note 1)
Low range			0.033 to 1.0000	0.200 to 24.000
Middle range			1.0000 to 1000.0	24.000 to 24000
High range			10.000 to 10000	240.000 to 240000
Set Slew Rate	Slew			
Low range	(shifted)	"V:SLW value"		(see Note 2)
Middle or High range		"C:SLW value"		
Set Transient Level	Tran Level	"R:TLV value"		(see Notes 1 and 3)
Low range			0.033 to 1.0000	0.200 to 24.000
Middle range			1.0000 to 1000.0	24.000 to 24000
High range			10.000 to 10000	240.000 to 240000

Notes:

- In the middle and high ranges, the resolution of the main level and the transient level degrades as higher values are entered. The value of resistance displayed will be the closest one to the value entered. A similar effect will occur with the **Input ▲** and **Input ▼** keys. Refer to Appendix A for considerations regarding high resistance applications.
- In the low resistance range, the resistance slew rate is programmed in volts/microsecond instead of in ohms/microsecond. Whatever value is programmed for the voltage slew rate (see "Setting CV Values") is also used for resistance in the low range. In the middle and high ranges, the resistance slew rate is programmed in amps/microsecond. Whatever value is programmed for the current slew rate (see "Setting CC Values") is also used for resistance in either the middle or high ranges.
- In the low range, the transient resistance level must be set to a higher value than the main resistance value. In the middle and high ranges, the transient resistance level must be set to a lower value than the main resistance value.

Changing the programming range can cause the present CR settings to be automatically adjusted to fit within the new range. For example, assume that you are programming the Agilent 6060B 300 Watt Electronic Load, the present range is 1 to 1 k ohms "R:RNG 1000.0", and the present settings are:

"RES 50.000" - main level is 50 ohms
"R:TLV 40.000" - transient level is 40 ohms
"C:SLW.50000" - slew rate is 0.5 A/ μ s (1 to 1 k ohms range uses the CC slew rate setting).

If you now select the low range (R:RNG 1.0000), the settings will automatically be changed to fit into the new range as follows:

"RES 1.0000" - main level is 1 ohm (maximum value low range)
"R:TLV 1.0000" - transient level is 1 ohm (maximum value low range)
"V:SLW 5.0000" - slew rate is 5 V/ μ s (low range uses the CV slew rate setting).

If you now select the high range (R:RNG 10000), the settings will be automatically adjusted to fit into the new range as follows:

"RES 10.000"-main level is 10 ohms (minimum value high range)
"R:TLV 10.000"-transient level is 10 ohms (minimum value high range)
"C:SLW .50000"-slew rate is 0.5 A/ μ s (high resistance range uses the CC slew rate setting).

Examples

The following examples illustrate how to set CR values. Before you do these examples, press **Recall** **7** **Enter** to set the CR values to their factory default states (see Table 4-6).

1. Set Range
 - a. Press **RES** to select the CR function. Now press **Range** to determine which range is presently selected. Note that the display indicates "R:RNG" and the maximum middle range resistance value. This means the middle range is presently selected.
 - b. Select the low range by pressing **.** **1** **Enter**
 - c. Press **Range** and note that the display indicates "R:RNG" and the maximum low range value. This means the low range is presently selected.
2. Set Main Level
 - a. Press **RES** and note that the display indicates "RES" and the maximum low range resistance value.
 - b. Set the main resistance level to 0.4 ohms by pressing **.** **4** **Enter**
 - c. Press **RES** again and check that the display indicates "RES 0.4000" .

You can use **Input** ENTRY keys to increment (**▲**) and decrement (**▼**) the RES setting. You can see the RES setting being incremented or decremented one step at a time each time you press the applicable Input key. The values are entered automatically (you don't press the Enter key). Remember if the CR mode is active, the incremented or decremented values will immediately change the actual input.

3. Set Slew Rate
 - a. First press the **Shift** (blue shift key) and note that the **Shift** annunciator goes on. Now press **Slew** (shifted Tran Level key) to determine the present slew setting. Note that the display indicates "V:SLW" and the maximum voltage slew rate. The Electronic Load automatically selects the voltage slew rate when the low resistance range is selected.
 - b. Set the slew rate to 0.25 V/ μ s by pressing **.** **2** **5** **Enter**
 - c. Press **Shift** and **Slew** again and check that the display indicates "V:SLW 0.2500" (or the closest slew rate step to this value for the particular model being programmed).

4. Set Transient Level-The transient resistance level "R:TLV" is meaningful only if transient operation (described later) is turned on.
 - a. Set the transient level to 0.8 ohm by pressing **Tran Level** **.** **8** **Enter**. Remember that in the low range the transient level must be set higher than the main level.
 - b. Press **Tran Level** again and note that the display indicates "R:TLV 0.8000". Note that you can use the Input ENTRY keys to increment and decrement the transient resistance level. Operation is similar to that described for the main resistance level.

Setting CV Values

The CV values for the are programmed by pressing the applicable FUNCTION keys and setting the desired values using the ENTRY keys. The display identifies the selected function; for example "V:TLV" identifies the transient voltage level.

Range

The voltage values can only be programmed in one range. The valid CV values are listed in Table 4-4 along with the applicable front panel key and display identifier. All voltage levels are programmed in volts and the voltage slew rate is programmed in volts/microsecond.

Table 4-4. CV Programming Ranges

Function	Key	Display	Range of Values	
			6060B	6063B
Set Main Level	VOLT	"VOLT value"	0.000 to 60.000	0.000 to 240.000
Set Slew Rate	Slew (shifted)	"V:SLW value"	0.0010 to 0.5000 (V/μs) (Note 1)	0.0040 to 2.000 (V/μs)
Set Transient Level	Tran Level	"V:TLV value"	0.000 to 60.000 (Note 2)	0.000 to 240.00

Notes:

1. There are 12-discrete steps within the voltage slew range. Because of bandwidth limitations, only 9 slew rate steps can be achieved (see Table 1-1). Any slew rate can be programmed. (There are no upper and lower limits that would cause an error.) The Electronic Load automatically selects one of the 12 slew rates that is closest to the programmed value. See *Chapter 2 Operation Overview* in this manual.
2. The transient voltage level is meaningful only if transient operation is turned on. The transient voltage level must be set to a higher value than the main voltage level. See *Transient Operation*.

Examples

The following examples illustrate how to program CV values. Before you do these examples, press **Recall** **7** **Enter** to set the CV values to their factory default values.

1. Set Main level
 - a. Set the main voltage level to 20 volts by pressing **VOLT** **2** **0** **Enter**
 - b. Press **VOLT** again and check that the display indicates "VOLT 20.000".

Note that you can use the **Input** ENTRY keys to increment (▲) or decrement (▼) the main VOLT level setting. You can see the VOLT setting being incremented or decremented one step at a time each time you press the applicable Input key. The values are entered automatically. (You don't press the Enter key.) Remember if the CV mode is active, the incremented or decremented values will immediately change the actual input.

2. Set Slew Rate
 - a. First press **[Shift]** (blue shift key) and note that the **Shift** annunciator goes on. Now press **[Slew]** (shifted Tran Level key) to determine the present slew setting. Note that the display indicates "V:SLW" and the maximum slew rate.
 - b. Set the slew rate to 0.5 V/us by pressing **[.] [5] [Enter]**
 - c. Press **[Shift]** and **[Slew]** again and note that the display indicates "V:SLW 0.5000" (or the closest slew rate step to this value depending upon the model being programmed).

3. Set Transient Level

- a. Set the transient voltage level to 30 volts by pressing **[Tran Level] [3] [0] [Enter]**
- b. Press **[Tran Level]** again and note that the display indicates "V:TLV 30.000".

Note that you can use the Input Entry keys to increment and decrement the transient voltage level. Operation is similar to that described above for the main voltage level.

Transient Operation

Transient operation can be used in the CC, CR, or CV mode. It causes the Electronic Load to switch between two load levels. Only continuous transient operation can be programmed from the front panel. Pulsed and toggled transient operation as well as continuous transient operation can only be programmed remotely via the GPIB computer.

In continuous transient operation, a repetitive pulse train switches between two load levels. Transient operation is turned on and off at the front panel using the Tran on/off key. Before you turn on transient operation, you should set the desired mode of operation as well as all of the values associated with transient operation.

The two load levels in transient operation are the main and transient levels previously described for CC, CR, and CV. The rate at which the level changes is determined by the associated slew rate setting.

In addition to the mode dependent parameters mentioned above, the frequency and the duty cycle of the continuous pulse train are programmable (see Table 4-5).

Table 4-5. Continuous Pulse Train Programming Ranges

Function	Key	Display	Range of Values
Frequency	[FREQ]	"FREQ value"	0.25 to 10000 Hz
Duty Cycle	[Dcycle] (shifted)	"DCYCLE value"	3 to 97% (0.25 Hz to 1 kHz) 6 to 94% (1 kHz to 10 kHz)

The following example illustrates how to program transient operation in the CC mode.

1. Setup CC Values

- a. Set the main CC level to 0.5 amps, the transient CC level to 1 amp, and the slew rate to 0.0025 A/μs. See examples under *Setting CC Values*.
- b. Turn on CC mode by pressing:

MODE **CURR** **Enter**

2. Set frequency to 5 kHz by pressing:

FREQ **5** **0** **0** **0** **Enter**

3. Set duty cycle to 25% by pressing:

(blue shift key) **Dcycle** (shifted) **2** **5** **Enter**

4. Turn on transient operation by pressing: **Tran On/Off**

5. Note that the **Tran** annunciator is on.

Shorting The Input

The Electronic Load can simulate a short circuit across its input. The short circuit can be toggled on/off by pressing **Short on/off**.

When the input is shorted the message "SHORT ON" will be displayed. The short on/off change uses the slew rate setting of the active mode and range. Turning the short off returns the input to the previously programmed values and returns the display to the metering mode. Note that "INPUT OFF" takes precedence over "SHORT ON".

CAUTION

Pressing the Short on/off key with certain user applications may cause damage to the equipment being tested, which may result in personal injury. Contact your Agilent Sales and Service office if you need to have the Short on/off key disabled.

Resetting Latched Protection

The Electronic Load includes overvoltage "OV", overpower "OP", and overtemperature "OT" protection features as well as a software overcurrent limit protection feature (remotely programmable only) that latch when they are tripped. The protection shutdown "PS" and voltage fault "VF" conditions also latch when tripped. The **Prot** annunciator on the front panel goes on when any of the above features are tripped. To reset any of these protection features, press **Prot Clear**.

Note

The condition that caused the protection feature to trip must be removed or it will trip again as soon as it is reset. Also, if OT occurs, the Electronic Load must have sufficiently cooled down in order for the **Prot Clear** to take effect.

Using The System Keys

These keys consist of Local, Address, Error (shifted Address key), Recall, Save (shifted Recall key), and the blue shift key. The Local key and the Shift key have already been discussed. The remaining SYSTEM keys are described in the following paragraphs.

Setting The Electronic Load's GPIB Address

Before you can program the Electronic Load remotely via a GPIB computer, you must know its GPIB address. You can find this out by pressing **Address** . The Electronic Load's GPIB address will be displayed; for example "ADDRESS 5". The Electronic Load is shipped from the factory with its address set to 5.

If you want to leave the address set at 5, you can return to the metering mode by pressing the Meter key.

If you want to change the address, you can enter a new value. Any integer from 0 to 30 can be selected. For example, to change the address to 12 press:

Address **1** **2** **Enter** .

This new address will remain set and will not be lost when power is cycled. Note that the Address setting is not affected by the Save and Recall functions described below.

Displaying Error Codes

Remote programming errors are indicated when the **Err** annunciator is on. To display the error code(s), first return to local control by pressing **Local** .

To display an error code, press **Shift** (blue shift key) **Error** (shifted).

Errors are recorded in a list and are displayed in the order in which they occurred. Each time the shifted Error key is pressed, an error code is displayed. Once an error is displayed, it is removed from the error list. "ERROR 0" indicates there are no errors present and will be displayed when all errors in the list have been displayed. The error codes are negative numbers in the range from - 100 to - 499. Refer to the *Agilent Electronic Loads Programming Reference Guide* for a description of the error codes.

Saving and Recalling Settings

The Electronic Load's settings (mode, input state, current levels, resistance levels, etc.) can be saved and then recalled for use in various test setups. The complete list of parameters that can be saved and recalled are the same parameters as listed in Table 4-6.

The present settings of all parameters can be saved in a specified storage register (0 to 6) using the Save (shifted Recall) key. At a later time, you can recall the settings from the specified register using the Recall key.

For example, you can store the present settings in register 2 by pressing **Shift** (blue shift key) **Save** (shifted) **2** **Enter** .

You can change the Electronic Load's settings as required and then return to the settings stored in register 2 by pressing **Recall** **2** **Enter** .

Settings stored in registers 1 through 6 will be lost when the Electronic Load's power is cycled. When power is turned off and then on again, each of these registers (1 through 6) will be set to the "wake-up" values. The "wake-up" values are stored in register 0 and can be set to any values you desire (see *Changing Wake-up Settings*).

The main advantage in using internal registers 1 through 6 is that it simplifies the repetitive programming of different settings. The Save key can be used in conjunction with the Input on/off key to store settings while the input is off. The Recall key can be used at a later time to recall desired settings while the input is turned on.

Table 4-6. Factory Default Settings

Function	Setting	
	6060B	6063B
Input on/off	on	on
Short on/off	off	off
CURR level	0 A	0 A
CURR transient level	0 A	0 A
CURR slew rate	1 A/ μ s	0.83 A/ μ s
CURR range	60 A	10 A
*CURR protection level	61.2 A	10.2 A
*CURR protection delay	15 s	15 s
*CURR protection on/off	off	off
VOLT level	60 V	240 V
VOLT transient level	60 V	240 V
VOLT slew rate	5 V/ μ s	2 V/ μ s
RES level	1000 Ω	2400 Ω
RES transient level	1000 Ω	24000 Ω
RES range	1000 Ω	24000 Ω
Mode	CC	CC
Transient Operation	off	off
Frequency	1 kHz	1 kHz
Duty Cycle	50%	50%
**Transient mode	continuous	continuous
*Pulse width	0.5 ms	0.5 ms
*Port0 output signal	TTL logic 0	TTL logic 0
*Calibration mode	off	off
*Trigger source	hold	hold

*Can only be programmed remotely via the GPIB.

**Continuous transient operation is the only mode of transient operation available at the front panel. Pulsed, toggled, and continuous transient operating modes may be programmed remotely via the GPIB.

Changing "Wake-up" Settings

The "wake-up" settings are stored in register 0. At power-on, the Electronic Load will "wake-up" with these values set. When the Electronic Load is shipped from the factory, its "wake-up" values are the same as its factory default values (see Table 4-6).

You can change the "wake-up" values to whatever values you wish. You do this by setting them into the Electronic Load and then saving them in register 0 by pressing

(blue shift key) **Save** (shifted Recall key) **0** **Enter**.

When power is turned off and on, the Electronic Load will be set to the values you saved in register 0.

CAUTION

The Save 0 operation takes a few seconds to complete. Do not turn power off until the "SAVE 0" message goes away indicating that the operation is complete. If you turn off power before completion, the Electronic Load's non-volatile memory will be corrupted and the Electronic Load will need to be recalibrated.

Recalling the Factory Default Values

You can recall the factory default values (see Table 4-6) for all modules by pressing: **Recall** **7** **Enter** .

As soon as the Enter key is pressed, the Electronic Load will be set to its factory default values. Note that the Electronic Load is also set to the factory default values when the *RST common command is sent via the GPIB (see the *Programming Reference Guide*).

If you also want the factory default settings to be the "wake-up" settings, you can recall them as described above and then press:

Shift (blue shift key) **Save** (shifted) **0** **Enter** .

Now, when power is turned off and on, the Electronic Load will be set to the factory default settings.

Remote Operation

Introduction

Chapter 4 - Local Operation described how to program the Electronic Load manually using the front panel keys. This chapter describes the fundamentals of programming the Electronic Load remotely from a GPIB controller. The similarities between local and remote programming will become apparent as you read this chapter.

The intent of this chapter is to help first time users quickly become familiar with operating their Electronic Load remotely from a GPIB controller. Only the most commonly used HPSL commands will be discussed. Programming examples given in this chapter use the HPSL commands in their simplest form (abbreviated commands, no optional key words, etc.).

Refer to the *Agilent Electronic Loads Programming Reference Guide* for a detailed description of all commands. The Programming Guide includes a complete Language Dictionary as well as a quick reference summary of all of the HPSL commands that can be used to program the Electronic Load. It also covers the Electronic Load's GPIB functions, status reporting capabilities, and error messages.

Note The programming examples that follow are written in BASIC Programming Language for use with HP Series 300 computers. You may convert these examples for use with any other language or computer.

Enter/Output Statements

You need to know the statements your computer uses to output and enter information. For example, the Agilent BASIC language statement that addresses the Electronic Load to listen and sends information to the Electronic Load is:

OUTPUT

The Agilent BASIC language statement that addresses the Electronic Load to talk and reads information back from the Electronic Load is:

ENTER

The Electronic Load's front panel **Rmt** annunciator is on when it is being controlled remotely via a GPIB controller and its **Addr** annunciator is also on when it is addressed to talk or to listen.

GPIB Address

Before you can program your Electronic Load remotely via a GPIB computer, you need to know its GPIB address. Each instrument you connect to the GPIB interface has a unique address assigned to it. The address allows the system controller to communicate with individual instruments.

The Electronic Load's GPIB address is set locally at the front panel using the Address key as described in Chapter 4. The examples in this chapter assume that the Electronic Load's address is 05.

Series 300 computers have a GPIB interface select code which is 7. Only one instrument connected to the interface can have address 05. Thus, the complete GPIB address assumed in the upcoming programming examples is 705. You may modify the examples to have any GPIB address.

Sending A Remote Command

To send the Electronic Load a remote command, combine your computer's output statement with the GPIB interface select code, the GPIB device (Electronic Load) address, and finally the Electronic Load's HPSL command. For example, to set the input current of a previously specified channel to 10 amps, send:

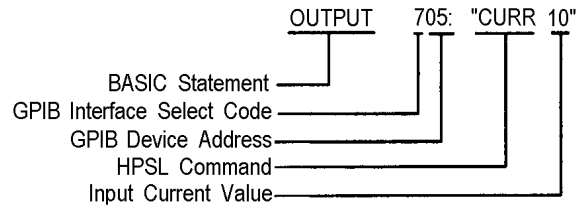

Getting Data Back

The Electronic Load is capable of reading back the values of parameter settings as well as its actual input voltage and current or computed input power. It can also return information relating to its internal operation and instrument identification. In order to read back the desired information, you must send the appropriate query to the Electronic Load. For example, the query "MEAS:CURR?" asks the Electronic Load to measure the actual input current at the INPUT binding posts. Refer to the *Agilent Electronic Loads Programming Reference Guide* for complete details on using queries.

The Electronic Load stores its response to the query in an output buffer which will hold the information until it is read by the computer or is replaced with new information.

Use your computer's enter statement to read the response from the Electronic Load's output buffer. The following example asks the Electronic Load its actual input current and then reads the response back to the computer.

```
10 OUTPUT 705; "MEAS:CURR?"
20 ENTER 705; A
30 DISP A
40 END
```

Line 10: Measures the actual input current.

Line 20: Reads the actual input current level back into variable A in the computer.

Line 30: Displays the input current value on the computer's display

Remote Programming Commands

The Electronic Load command set consists of more than 60 HPSL compatible commands. The HPSL commands have many optional key words which can be used to document your programs. Most of the commands have a query syntax which allows the present parameter settings to be read back to the controller. All of these details are given in the *Agilent Electronic Loads Programming Reference Guide*.

The Electronic Load's major functions can be programmed using a relatively few number of these commands. Figure 5-1 illustrates how to program these functions using the applicable HPSL commands. Table 5-1 lists the programming ranges associated with each function as well as the applicable HPSL commands. The factory default settings for each function are listed in Table 4-6.

The remaining paragraphs in this chapter give a few simple programming examples to help you get started. In each example, it is assumed that a dc power source is connected to the Electronic Load's input binding posts. Also, the following points are important to remember when you are remotely programming current, resistance and voltage values.

1. Modes

The **CC**, **CR**, and **CV** values can be programmed whether or not the associated mode is active. If the input is turned on, all of the applicable values will take effect at the input when the associated mode is selected.

2. Ranges

Changing the **CC** or **CR** programming range can cause the present settings to be automatically adjusted to fit within the new range. See *Setting CC Values and Setting CR Values* in Chapter 4. During a range change, the input will go through a non-conducting state to minimize overshoots.

3. Transient levels

The transient **CC** or **CV** level must be set to a higher level than the respective main level. In the low range, the transient **CR** level must be set to a higher level than the main **CR** level. In the middle and high ranges, the transient **CR** level must be set to a lower level than the main **CR** level.

4. Slew Rates

The **CC** slew rate is programmed in amps/second. There are 12-steps for each of the two current ranges (low and high). The Electronic Load automatically selects one of the 12 steps that is closest to the programmed value. The **CV** slew rate is programmed in volts/second. There are 12-steps within the voltage range. The Electronic Load automatically selects one of the 12 steps that is closest to the programmed value. In the low range, the **CR** slew rate is programmed in volts/second instead of ohms/second. Whatever value is programmed for the **CV** slew rate is also used for **CR**. In the middle and high ranges, the **CR** slew rate is programmed in amps/second. Whatever value is programmed for the **CC** slew rate is also used for **CR**.

5. Programmable Current Protection (CURR:PROT)

The programmable current limit is in effect for any mode of operation (not just the **CC** mode). When programmable current protection is enabled, and the programmed current limit and time delay are exceeded, the module's input will be turned off.

6. Measurement Overload (OVLN)

If the input voltage exceeds the maximum measurement capability of the load, an overload (OVLN) condition will be indicated in the return values that resulted from a MEAS:VOLT? or MEAS:POW? query sent to the associated channel. The MEAS:POW? query will return an overload indication if either voltage or current has exceeded the module's maximum measurement capability since power is calculated from voltage and current. Overload is indicated by the value 9.9E + 37 instead of the normal voltage or power readings. This is the IEEE 488.2 value for positive infinity.

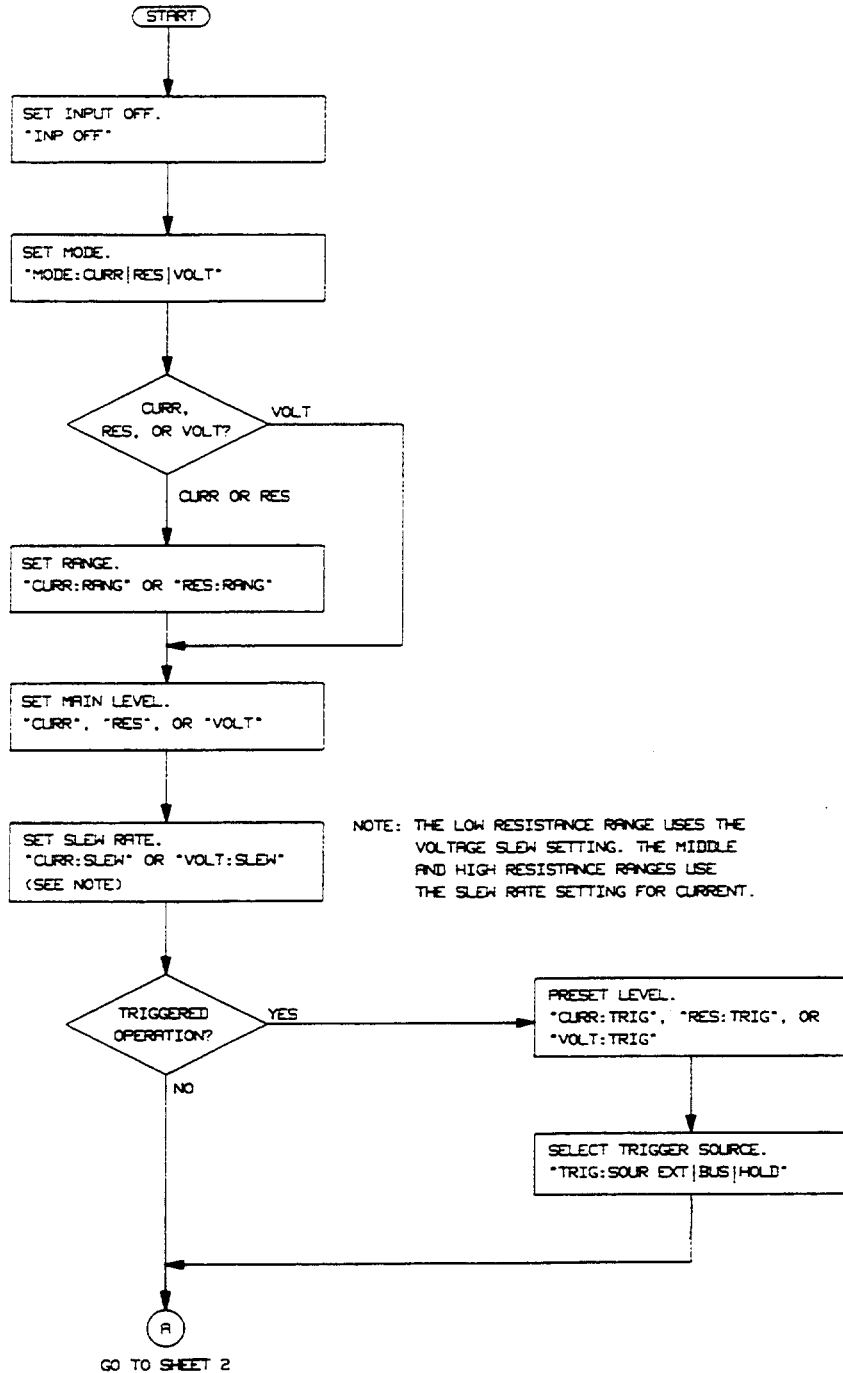

Figure 5-1. Remote Programming Flowchart (Sheet 1)

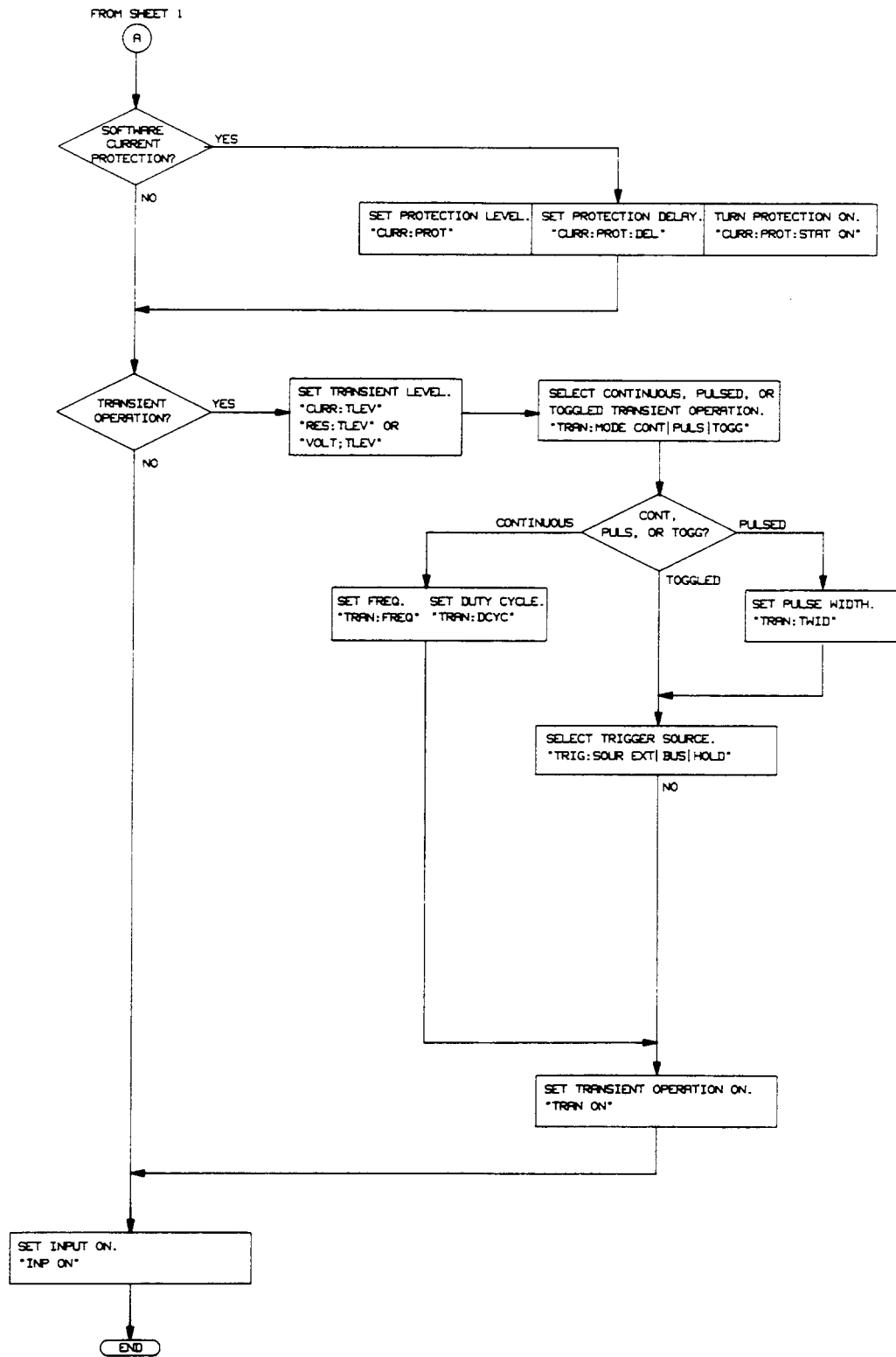

Figure 5-1. Remote Programming Flowchart (Sheet 2)

CC Mode Example

This example sets the current level to 0.75 amps and then reads back the actual current value.

```
10 OUTPUT 705;"INPUT OFF"  
20 OUTPUT 705;"MODE:CURR"  
30 OUTPUT 705;"CURR:RANG 1"  
40 OUTPUT 705;"CURR 0.75"  
50 OUTPUT 705;"INPUT ON"  
60 OUTPUT 705;"MEAS:CURR?"  
70 ENTER 705;A  
80 DISP A  
90 END
```

Line 10: Turns off Electronic Load input.
Line 20: Selects the CC mode.
Line 30: Selects the low current range.
Line 40: Sets the current level to 0.75 amps.
Line 50: Turns on Electronic Load input.
Line 60: Measures the actual input current and stores it in a buffer inside the Electronic Load.
Line 70: Reads the input current value into variable A in the computer.
Line 80: Displays the measured current value on the computer's display.

CV Mode Example

This example presets the voltage level to 10 volts, and selects the external trigger source.

```
10 OUTPUT 705; "INPUT OFF"  
20 OUTPUT 705;"MODE: VOLT"  
30 OUTPUT 705;"VOLT:TRIG 10"  
40 OUTPUT 705;"TRIG:SOUR EXT"  
50 OUTPUT 705;"INPUT ON"  
60 END
```

Line 10: Turns off Electronic Load input.
Line 20: Selects the CV mode.
Line 30: Presets the voltage level to 10 volts.
Line 40: Selects the external input as the trigger source.
Line 50: Turns on Electronic Load input.

In this example, when the Electronic Load receives the external trigger signal, the input voltage level will be set to 10 volts.

CR Mode Example

This example sets the current protection limit to 2 amps, programs the resistance level to 100 ohms, and reads back the computed power. See Appendix A for considerations regarding high-resistance applications.

```
10 OUTPUT 705;"INPUT OFF"  
20 OUTPUT 705; "MODE:RES"  
30 OUTPUT 705;"CURR:PROT:LEV 2;DEL 5"  
40 OUTPUT 705;"CURR:PROT:STAT ON"  
50 OUTPUT 705;"RES:RANG 25"  
60 OUTPUT 705;"RES 100"
```

```

70 OUTPUT 705;"INPUT ON"
80 OUTPUT 705;"MEAS:POW?"
90 ENTER 705;A
100 DISP A
110 END

```

- Line 10: Turns off Electronic Load input.
- Line 20: Selects the CR mode.
- Line 30: Sets the current protection limit to 2 A with a trip delay of 5 seconds.
- Line 40: Enables the current protection feature.
- Line 50: Selects the middle range.
- Line 60: Sets the resistance level to 100 ohms.
- Line 70: Turns on Electronic Load input.
- Line 80: Measures the computed input power level and stores it in a buffer inside the Electronic Load.
- Line 90: Reads the computed power level into variable A in the computer.
- Line 100: Displays the computed power level on the computer's display.

Continuous Transient Operation Example

This example sets the CC levels and programs the slew, frequency, and duty cycle parameters for continuous transient operation.

```

10 OUTPUT 705;"INPUT OFF"
20 OUTPUT 705;"MODE:CURR"
30 OUTPUT 705;"CURR .5"
40 OUTPUT 705;"CURR:TLEV 1;SLEW 2500"
50 OUTPUT 705;"TRAN:MODE CONT;FREQ 5000;DCYC 40"
60 OUTPUT 705;"TRAN ON"
70 OUTPUT 705;"INPUT ON"
80 END

```

- Line 10: Turns off Electronic Load input
- Line 20: Selects the CC mode.
- Line 30: Sets the main current level to .5 A.
- Line 40: Sets the transient current level to 1 A and the slew rate to 2500 A/s (or the closest slew rate step to this value depending upon the model being programmed).
- Line 50: Selects continuous transient operation, sets the transient generator frequency to 5 kHz, and sets the duty cycle to 40%.
- Line 60: Turns on the transient generator.
- Line 70: Turns on Electronic Load input.

Pulsed Transient Operation Example

This example sets the CR levels, selects the bus as the trigger source, sets the fastest slew rate, programs a pulse width of 1 millisecond for pulsed transient operation.

```

10 OUTPUT 705;"INPUT OFF"
20 OUTPUT 705;"MODE:RES"
30 OUTPUT 705;"RES 10"
40 OUTPUT 705;"RES:TLEV 5"
50 OUTPUT 705;"TRIG:SOUR BUS"
60 OUTPUT 705;"CURR:SLEW 5000000"
70 OUTPUT 705;"TRAN:MODE PULS;TWID .001"

```

```

80 OUTPUT 705;"TRAN ON
90 OUTPUT 705;"INPUT ON"
.
.
.
.
200 OUTPUT 705;"*TRG"
210 END

```

- Line 10: Turns off Electronic Load input.
- Line 20: Selects the CR mode.
- Line 30: Selects the main resistance level to 10 ohms.
- Line 40: Sets the transient resistance level to 5 ohms. Remember in the 1 to 1k range, the transient resistance level must be set to a lower level than the main resistance level.
- Line 50: Selects the GPIB as the trigger source.
- Line 60: Sets the current slew rate to the fastest rate. Remember that in the middle range, the resistance slew rate is programmed in amps/second.
- Line 70: Selects pulsed transient operation and sets the pulse width to 1 millisecond.
- Line 80: Turns on the transient generator.
- Line 90 Turns on Electronic Load input.
- Line 100
to Other commands are executed.
- Line 190
- Line 200: The *TRG command generates a 1 millisecond pulse at the Electronic load input.

Table 5-1. Remote Programming Ranges

Function	HPSL Command (Short Form)	Range of Values	
Constant Current (CC)			
Set Range	"CURR:RANG value"		
Low Range		6060B ≥ 0 and ≤ 6 A	6063B ≥ 0 and ≤ 1 A
High Range		> 6 and ≤ 60 A	> 1 and ≤ 10 A
Set Main Level	'CURR value"		
Low Range		0 to 6 A	0 to 1 A
High Range		0 to 60 A	0 to 10 A
Set Slew Rate	"CURR:SLEW value"		
Low Range	.	100 to 500,000 A/s	1.7 to 83,000 A/s
High Range		1000 to 5,000,000 A/s	17 to 830,000 A/s
Set Transient Level	"CURR:TLEV value"		Same as CC main level
*Set Triggered Level	"CURR:TRIG value"		Same as CC main level

Table 5-1. Remote Programming Ranges (continued)

Function	HPSL Command (Short Form)	Range of Values	
Constant Resistance (CR)			
Set Range	"RES:RANG value"	6060B	6063B
Low Range		≥ 0 or ≤ 1 Ω	≥ 0 and ≤ 24 Ω
Middle Range		>1 Ω and ≤ kΩ	≤ 24 Ω and ≤ 24 kΩ
High Range		>1 kΩ and ≤ kΩ	>24 kΩ and ≤ 240 kΩ
Set Main Level	'RES value"		
Low Range		0 to 1 Ω	0 to 24 Ω
Middle Range		1 Ω to 1 kΩ	24 Ω to 24 kΩ
High Range		10 Ω to 10 kΩ	240 Ω to 240 kΩ
Set Slew Rate			
Low Range	"VOLT: SLEW value"		Same as CV slew rate
Middle/High Range	"CURR:SLEW value"		Same as CC slew rate
Set Transient Level	"RES:TLEV value"		Same as main CR level
*Set Triggered Level	"RES:TRIG value"		Same as main CR level
Constant Voltage (CV)		6060B	6063B
Set Main Level	"VOLT value"	0 to 60 V	0 to 240 V
Set Slew Rate	"VOLT:SLEW value"	1000 to 5,000,000 V/s	4000 to 2,000,000 V/s
Set Transient Level	"VOLT:TLEV value"		Same as main CV level
*Set Triggered Level	"VOLT:TRIG value"		Same as main CV level
Transient Operation			
Set Frequency	"TRAN:FREQ value"		0.25 to 10000 Hz
Set Duty Cycle	"TRAN:DCYC value"		3 to 97% (0.25 Hz to 1 kHz) 6-94% (1 kHz-10 kHz)
*Set Pulse Width	"TRAN:TWID value"		0.00005 to 4 seconds
Current Protection		6060B	6063B
*Set Current Level	"CURR:PROT value"	0 to 61.2 A	0 to 10.2 A
*Set Delay Time	"CURR:PROT:DEL value"		0 to 60 seconds
*Can only be programmed remotely via the GPIB.			

Calibration

Introduction

This chapter describes the calibration procedures for the Electronic Load and gives a sample calibration program. The Electronic Load should be calibrated annually, or whenever certain repairs are made (refer to the Service Manual). Calibration is accomplished entirely in software by sending calibration constants to the Electronic Load via the GPIB. This means that the Electronic Load can be calibrated without removing its cover, or removing it from its cabinet if rack mounted.

There are three DACs in the Electronic Load that must be calibrated - a main DAC, a readback DAC, and a transient level DAC. Six ranges must be calibrated for both the main DAC and the transient DAC - a voltage range, a low resistance range, a middle resistance range, a high resistance range, a low current range, and a high current range. The main DAC requires two operating points to be calibrated for each range - a high point and a low point. The transient DAC requires only the high operating point to be calibrated for each range; it uses the same low operating point as the main DAC. Note that the transient level for the middle and high resistance ranges is lower than the high level of the main DAC.

The readback DAC is only calibrated for the high current range and the voltage range. It also requires two operating points to be calibrated for each range - a high point and a low point. For the sake of convenience you can use the same values to calibrate the main and the readback DAC, but you could also use different values to optimize accuracy.

Note All calibration must be done when the Electronic Load is at room temperature.

Example Programs

The example programs in this chapter are written using the, Agilent BASIC Language. If you are using an HP Series 200/300 computer, simply type in the programs and run them. At appropriate places in the program you will be prompted to measure and enter values into the computer and verify that the values are within specifications.

If you are using a different computer or programming language, you will have to modify the programs before you can run them.

Equipment Required

Table 6-1 lists the equipment required for calibration. Note that less accurate and less expensive current shunts may be used than those listed, but the accuracy to which current and resistance programming as well as readback, can be checked must be reduced accordingly. Figure 6-1 illustrates how the calibration equipment should be connected.

Table 6-1. Equipment Required for Calibration

Equipment	Characteristics	Recommended Model
Shunts	0.1 Ω @ 15 A, 0.04% @ 25 W	Guildline 9230/15
	0.01 Ω @ 100 A, 0.04% @ 100 W	Guildline 9230/100
Voltmeter	dc accuracy of 0.01%, 6 digit readout	Agilent 3456A or equivalent
Power Supply	240 Vdc/60 Adc minimum PARD < 3 mV rms/30 mv pp	Agilent 6032A or Agilent 6035A and Agilent 6031A, or equivalent
Controller	GPIB (IEEE-488)	Agilent BASIC (5.0/5.1)

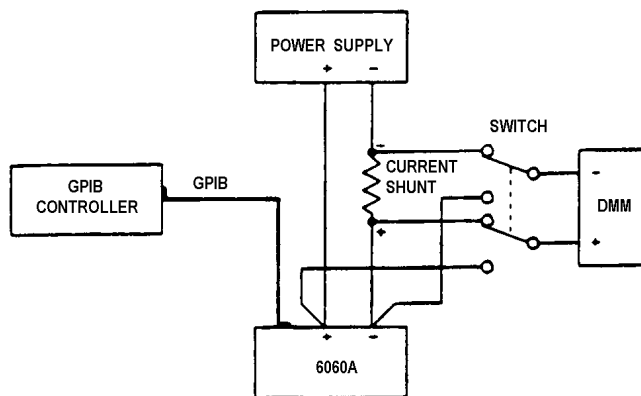

Figure 6-1. Calibration Equipment Setup

Calibration Commands

The following calibration commands are required to calibrate the Electronic Load. They are used in the program examples included in this section. Refer to the *Agilent Electronic Loads Programming Reference Guide* for HPSL commands.

CALibration:[MODE] ON|OFF

Turns the calibration mode on or off.

CALibration:LEVel:HIGH <NRf>

Enters the actual high level value (measured by an external instrument) that corresponds to the present high level setting. An error is generated if the high level value is not greater than the low level value. Both high and low **CAL:LEV** commands must be sent before the constants are recalculated and stored in RAM.

CALibration:LEVel:LOW <NRf>

Enters the actual low level value (measured by an external instrument) that corresponds to the present low level setting. An error is generated if the low level value is not less than the high level value. Both high and low **CAL:LEV** commands must be sent before the constants are recalculated and stored in RAM.

CALibration:TLEVel[:HIGH] <NRf >

Enters the actual transient level value (measured by an external instrument) that corresponds to the present transient setting. The low level value of the main DAC is used as the low point for the transient calibration. Note that for the middle and high resistance ranges, the transient level is LOWER than the high level of the main DAC.

CALibration:MEASure:HIGH <NRf>

Enters the actual high level value (measured by an external instrument) that corresponds to the present high level setting. The input signal must remain applied to the Electronic Load while this command is executed because the unit takes a reading with the readback DAC to calibrate itself. An error is generated if the high level value is not greater than the low level value. Both high and low **CAL:MEAS** commands must be sent before the constants are recalculated and stored in RAM.

CALibration:MEASure:LOW <NRf>

Enters the actual low level value (measured by an external instrument) that corresponds to the present low level setting. The input signal must remain applied to the Electronic Load while this command is executed because the unit takes a reading with the readback DAC to calibrate itself. An error is generated if the low level value is not less than the high level value. Both high and low **CAL:MEAS** commands must be sent before the constants are recalculated and stored in RAM.

CALibration:SAVE

Writes the present calibration constants into the EEPROM. This command does not have to be sent until all ranges and modes have been calibrated. If the unit is turned off before **CAL:SAVE** is sent, the new calibration constants are lost

Calibration Flowcharts

The flowchart in Figures 6-2 describes the calibration procedure. It corresponds to the example calibration program. The flowchart indicates the appropriate statement that is used in the program example to accomplish each step. It also indicates when to set the power supply to the appropriate voltage and current output. Refer to Table 6-2 for the variable values, power supply settings, and current shunts associated with the model that you are calibrating.

Calibration mode is turned on at the beginning of the calibration procedure. Remember to save the calibration constants after you have verified that they are within specifications. Do not turn calibration mode off until after you have saved the new calibration constants - otherwise the new calibration constants will be lost.

Note

When calibrating the high calibration point of the high current range and high current transient level, you must wait about 30 seconds for the internal current shunt of the module to stabilize with the full current applied before you execute the **CAL:MEAS:HIGH** command. Because the high current range calibration causes the Electronic Load to heat up, you should also allow about 30 seconds time for the unit to cool down to room temperature before continuing to calibrate any other modes or ranges.

One shortcut that is used in this calibration procedure is that the readback DAC is calibrated for current readback after the high current range calibration, and calibrated for voltage readback after the voltage range calibration. This is because the readback setups are the same as the setups for the high current and voltage ranges. Another shortcut is that the same values are used to calibrate the main DAC as well as the readback DAC. You may wish to use different values to calibrate the readback DAC to optimize accuracy.

It is not necessary to calibrate the current readback for the low current range or for reading back resistance values. This is because the high current readback calibration takes care of the low current range. The resistance values that are readback are calculated based on the voltage at the input terminals and the current through the internal current shunt resistor. If the readback DAC has been calibrated for voltage and current readback, resistance readback will be accurate.

Note

Remember to turn the unit off after you have saved the new calibration constants. When the unit is turned on again, the new calibration constants are used to recalculate the software OP and OC limits. These limits are not updated until power is cycled.

Example Program

The example program in this chapter is written in the Agilent BASIC Language. If you are using an HP Series 200/300 computer, simply type in the program and run it. If you are using a different computer or programming language, you will have to modify the program before you can run it.

The program can be used to calibrate all Electronic Load models. You must specify the address of the Electronic Load that you are calibrating as shown in line 10. (The program assumes address 705.) Line 20 specifies channel 1 which is the channel number used by all Single Input Electronic Load models. You must make the variable assignments for the model that you are calibrating in lines 40 through 90. Refer to table 6-2 for the values that apply to the model you are calibrating. *Do not change the last value (Flag) in lines 40, 50, 70, 80, and 90.*

When the program is run, it will stop at appropriate places and prompt you to set the power supply according to Table 6-2, enter your measured values into the computer, and verify that the values are within specifications.

Table 6-2. Calibration Information

Ranges and Calibration Points	Variables	Variable Values	6060B Power Supply Settings	Current Shunt	Variable Values	6063B Power Supply Settings	Current Shunt
High Current Range	Hi_curr_rng	60	5 V/61 A	100 A	10	25 V/10.5 A	15 A
High Current Offset	Hi_curr_offset	0.0282			0.0048		
Low Current Range	Lo_curr_rng	6	5 V/10 A	15 A	1	25 V/2 A	15A
Low Current Offset	Lo_curr_offset	0.0197			0.0032		
Voltage Range	N/A	N/A	61 V/5 A	N/A	N/A	246 V/0.6 A	N/A
Voltage Hi point	Volt_hipt	60			240		
Voltage Lo point	Volt_lopt	2.7			2		
Low Resistance Range	Lo_res_rng	1	15 V/10.9 A	15 A	24	60 V/1.8 A	15 A
Low Resistance Hi point	Lo_res_hipt	1			23.9		
Low Resistance Lo point	Lo_res_lopt	.04			.88		
Middle Resistance Range	Mid_res_rng	10	10.9 V/15 A	15 A	240	43.6 V/4 A	15 A
Middle Resistance Hi point	Mid_res_hipt	30			500		
Middle Resistance Lo point	Mid_res_lopt	1			24		
High Resistance Range	Hi_res_rng	1001	60 V/6 A	15 A	24020	*240 V/2 A	15 A
High Resistance Hi point	Hi_res_hipt	120			2000		
High Resistance Lo point	Hi_res_lopt	12			240		

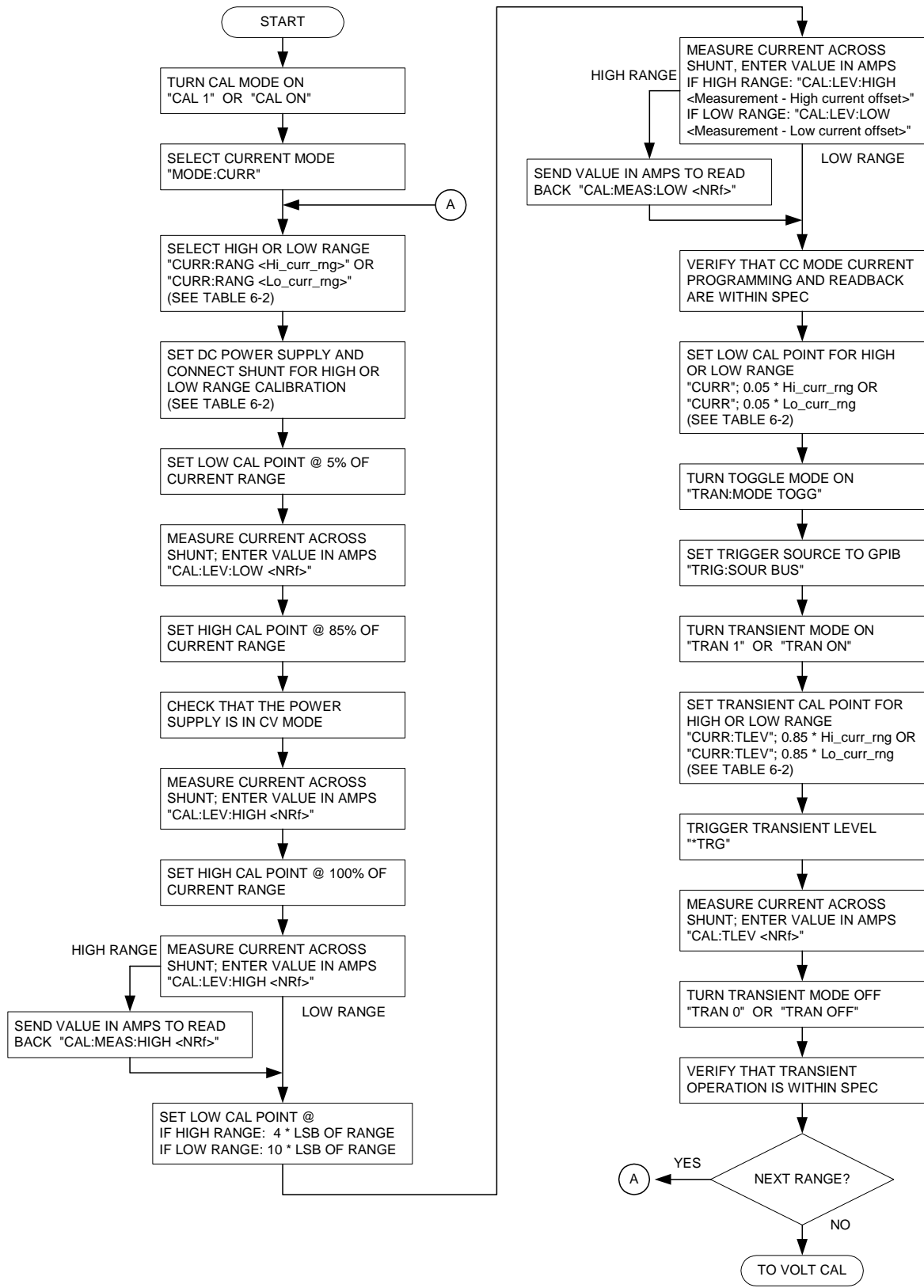

Figure 6-2. Calibration Flowchart

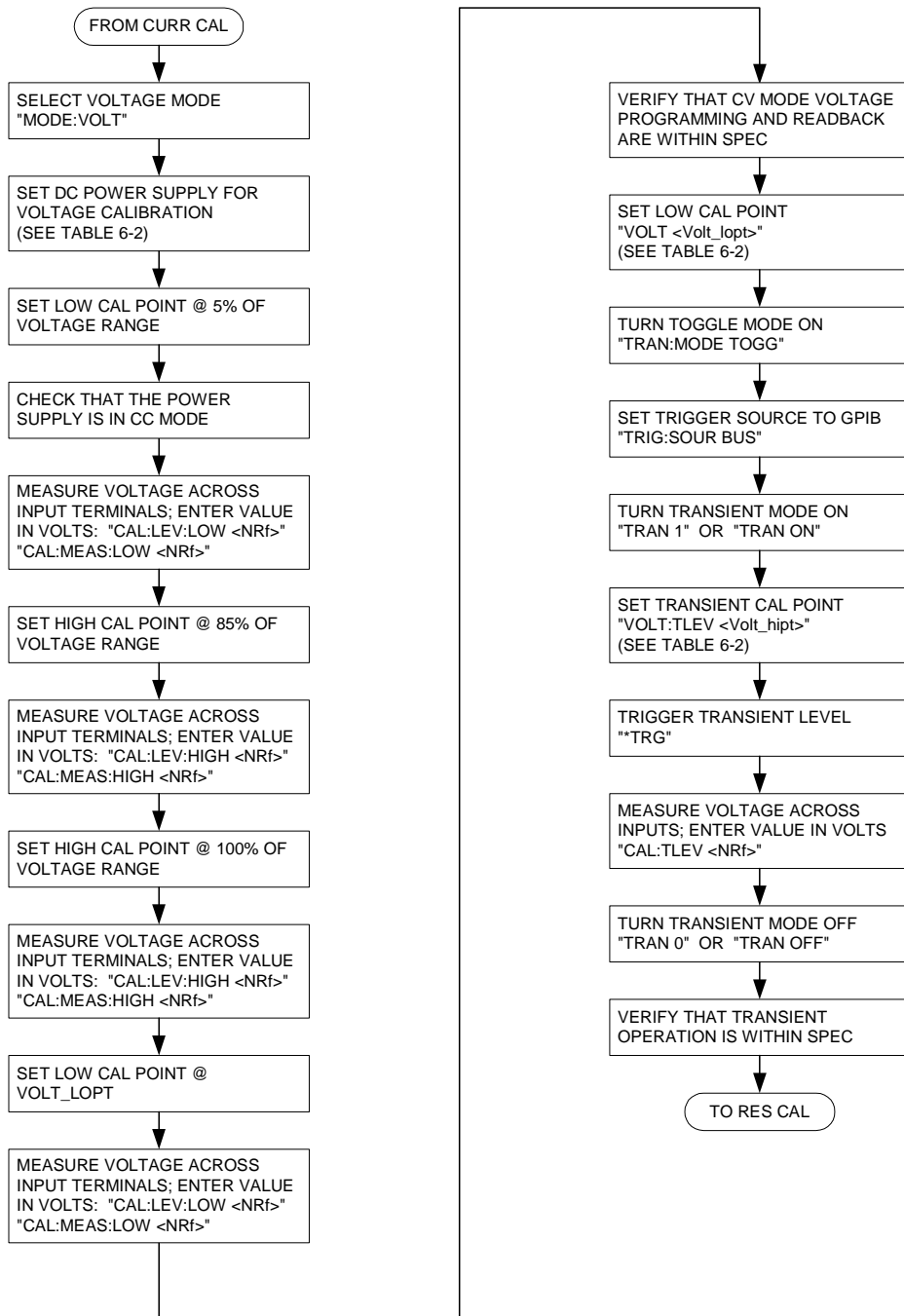

Figure 6-2. Calibration Flowchart (continued)

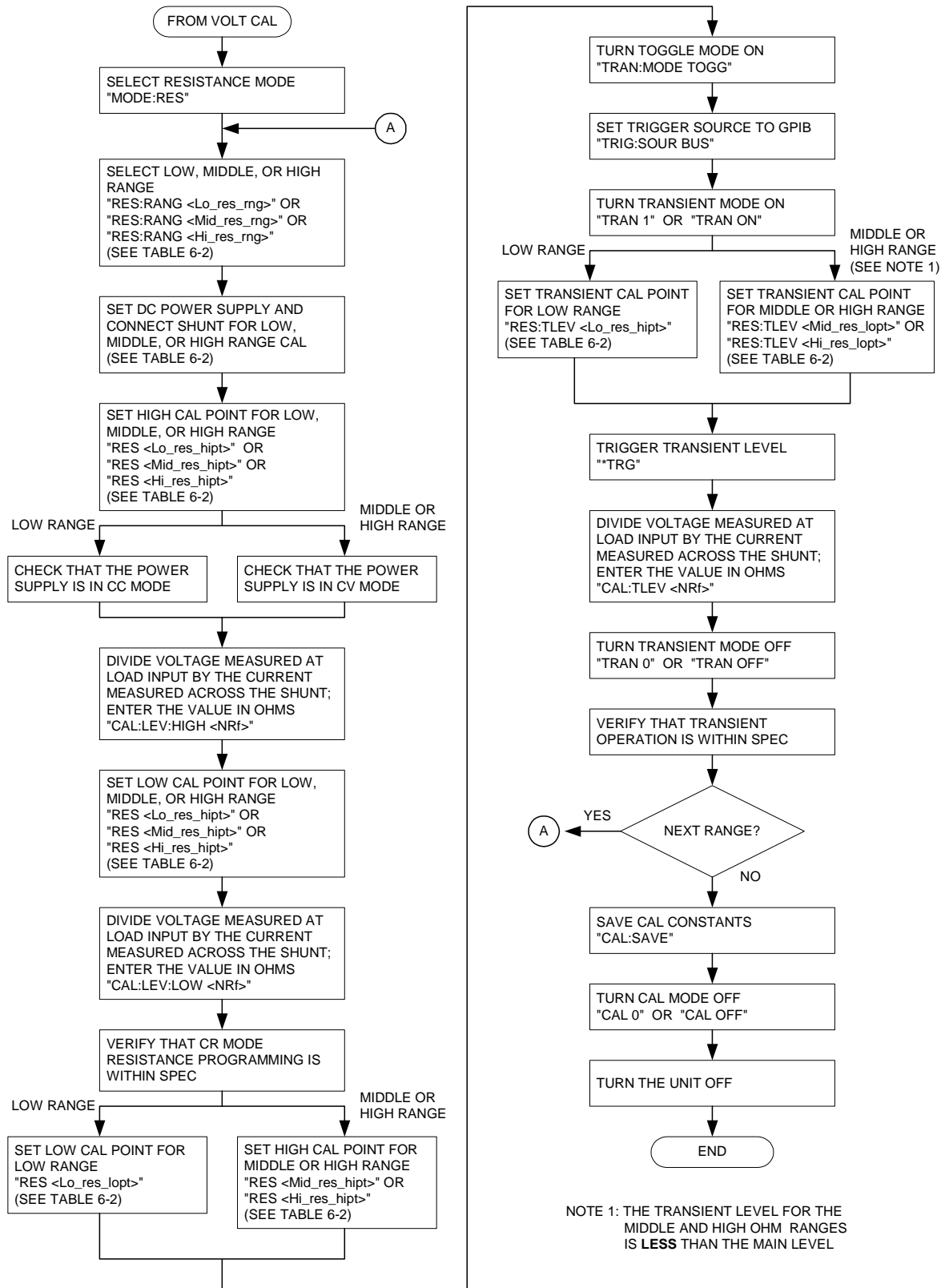

Figure 6-2. Calibration Flowchart (continued)

Program Listing

```
10    ASSIGN @Ld TO 705
20    Chan=l
30    OUTPUT @Ld;"CHAN";Chan;";CAL ON"
40    Cal_curr(@Ld,Chan,Hi_curr_rng,Hi_curr_offset,l)
50    Cal_curr(@Ld,Chan,Lo_curr_rng,Lo_curr_offset,0)
60    Cal_volt(@Ld,Chan,Volt_hipt,Volt_lopt)
70    Cal_res(@Ld,Chan,Lo_res_rng,Lo_res_hipt,Lo_res_lopt,0)
80    Cal_res(@Ld,Chan,Mid_res_rng,Mid_res_hipt,Mid_res_lopt,l)
90    Cal_res(@Ld,Chan,Hi_res_rng,Hi_res_hipt,Hi_res_lopt,1)
100   OUTPUT @Ld;"CAL:SAV"
110   OUTPUT @Ld;"CAL OFF"
120   END
130   !
140   SUB Cal_curr(@Ld,Chan,Curr_rng,Curr_offset,Flag)
150   PRINT "CURRENT CALIBRATION, RANGE ";Curr_rng
160   PRINT "Set power supply according to calibration information table"
170   PRINT "Use the correct current shunt for the range you are calibrating"
180   PRINT "Press CONT when ready"
190   PAUSE
200   OUTPUT @Ld;"CHAN";Chan
210   OUTPUT @Ld;"MODE:CURR"
220   OUTPUT @Ld;"CURR:RANG";Curr_rng
230   OUTPUT @Ld;"CURR";.05*Curr_rng
240   INPUT "Enter current through shunt for low point in amps",Lopt_curr
250   OUTPUT @Ld;"CAL:LEV:LOW";Lopt_curr
260   OUTPUT @Ld;"CURR";.85*Curr_rng
270   IF Flag THEN WAIT 25
280   INPUT "Enter current through shunt for high point in amps",Hipt_curr
290   OUTPUT @Ld;"CAL:LEV:HIGH";Hipt_curr
300   OUTPUT @Ld;"CURR";Curr_rng
310   INPUT "Enter current through shunt for high point in amps",Hipt_curr
320   OUTPUT @Ld;"CAL:LEV:HIGH";Hipt_curr
330   IF Flag THEN OUTPUT @Ld;"CAL:MEAS:HIGH";Hipt_curr
340   IF Flag THEN WAIT 25
350   IF Flag THEN
360   OUTPUT @Ld;"CURR";4*(Curr_rng/3750)
370   WAIT 1
380   INPUT "Enter current through shunt for low point in amps",Lopt_curr
390   OUTPUT @Ld;"CAL:LEV:HIGH";(Lopt_curr-Curr_offset)
400   OUTPUT @Ld;"CAL:MEAS:HIGH";Lopt_curr
410   ELSE
420   OUTPUT @Ld;"CURR";10*(Curr_rng/3750)
430   INPUT "Enter current through shunt for low point in amps",Lopt_curr
440   OUTPUT @Ld;"CAL:LEV:LOW";(Lopt_curr-Curr_offset)
450   END IF
460   PRINT "Test unit to verify that program and readback values are in spec"
470   PRINT "Press CONT when ready to calibrate transient levels"
480   PAUSE
490   OUTPUT @Ld;"CURR";.05*Curr_rng
500   OUTPUT @Ld;"TRAN:STAT ON;MODE TOGG;:TRIG:SOUR BUS"
510   OUTPUT @Ld;"CURR:TLEV";.85*Curr_rng
```

Program Listing (continued)

```
520  OUTPUT @Ld;"*TRG"
530  IF Flag THEN WAIT 30
540  INPUT "Enter current through shunt for high point in amps",Trpt_curr
550  OUTPUT @Ld;"CAL:TLEV";Trpt_curr
560  OUTPUT @Ld;"TRAN OFF"
570  PRINT "Test unit to verify that transient values are in spec"
580  PRINT "Press CONT when ready to calibrate next range or mode"
590  PAUSE
600  SUBEND
610  !
620  SUB Cal_volt(@Ld,Chan,Volt_hipt,Volt_lopt)
630  PRINT "VOLTAGE CALIBRATION"
640  PRINT "Set power supply according to calibration information table"
650  PRINT "Press CONT when ready"
660  PAUSE
670  OUTPUT @Ld;"CHAN";Chan
680  OUTPUT @Ld;"MODE:VOLT"
690  OUTPUT @Ld;"VOLT";.05*Volt_hipt
700  WAIT 3
710  INPUT "Enter voltage across input terminals for low point in volts",Lopt_v
720  OUTPUT @Ld;"CAL:LEV:LOW";Lopt_volts
730  OUTPUT @Ld;"CAL:MEAS:LOW";Lopt_volts
740  OUTPUT @Ld;"VOLT";.85*Volt_hipt
750  WAIT 3
760  INPUT "Enter voltage across input terminals for high point in volts", Hipt_
770  OUTPUT @Ld;"CAL:LEV:HIGH";Hipt_volts
780  OUTPUT @Ld;"CAL:MEAS:HIGH";Hipt_volts
790  OUTPUT @Ld;"VOLT";Volt_lopt
800  WAIT 3
810  INPUT "Enter voltage across input terminals for low point in volts",Lopt_v
820  OUTPUT @Ld;"CAL:LEV:LOW";Lopt_volts
830  OUTPUT @Ld;"CAL:MEAS:LOW";Lopt_volts
840  OUTPUT @Ld;"VOLT";Volt_hipt
850  WAIT 3
860  INPUT "Enter voltage across input terminals for high point in volts", Hipt_
870  OUTPUT @Ld;"CAL:LEV:HIGH";Hipt_volts
880  OUTPUT @Ld;"CAL:MEAS:HIGH";Hipt_volts
890  PRINT "Test unit to verify that program and readback values are in spec"
900  PRINT "Press CONT when ready to calibrate transient level"
910  PAUSE
920  OUTPUT @Ld;"VOLT";Volt_lopt
930  OUTPUT @Ld;"TRAN:STAT ON;MODE TOGG;:TRIG:SOUR BUS"
940  OUTPUT @Ld;"VOLT:TLEV";Volt_hipt
950  OUTPUT @Ld;"*TRG"
960  INPUT "Enter voltage across input terminals for transient point in volts"
970  OUTPUT @Ld;"CAL:TLEV";Trpt_volts
980  OUTPUT @Ld;"TRAN OFF"
990  PRINT "test unit to verify that transient values are in spec"
1000 PRINT "Press CONT when ready to calibrate next mode"
1010 PAUSE
1020 SUBEND
```

Program Listing (continued)

```
1030  !
1040  SUB Cal_res(@Ld,Chan,Res_rng,Res_hipt,Res_lopt,Flag)
1050  PRINT "RESISTANCE CALIBRATION, RANGE";Res_rng
1060  PRINT "Set power supply to calibration information table"
1070  PRINT "Press CONT when ready to continue"
1080  PAUSE
1090  OUTPUT @Ld;"CHAN";Chan
1100  OUTPUT @Ld;"MODE:RES"
1110  OUTPUT @Ld;"RES:RANG";Res_rng
1120  OUTPUT @Ld;"RES";Res_hipt
1130  INPUT "Enter voltage across input terminals in volts",Hipt_volt
1140  INPUT "Enter current through current shunt in amps",Hipt_curr
1150  Hipt_res=Hipt_volt/Hipt_curr
1160  OUTPUT @Ld;"CAL:LEV:HIGH";Hipt_res
1170  OUTPUT @Ld;"RES";Res_lopt
1180  INPUT "Enter voltage across input terminals in volts",Lopt_volt
1190  INPUT "Enter current through current shunt in amps",Lopt_curr
1200  Lopt_res=Lopt_volt/Lopt_curr
1210  OUTPUT @Ld;"CAL:LEV:LOW;Lopt_res
1220  PRINT "Test unit to verify resistance values"
1230  PRINT "Press CONT when ready to calibrate transient level"
1240  PAUSE
1250  IF Flag THEN
1260  OUTPUT @Ld;"RES";Res_hipt
1270  ELSE
1280  OUTPUT @Ld;"RES";Res_lopt
1290  END IF
1300  OUTPUT @Ld;"TRAN:STAT ON;MODE TOGG;:TRIG:SOUR BUS"
1310  IF Flag THEN
1320  OUTPUT @Ld;"RES:TLEV";Res_lopt
1330  ELSE
1340  OUTPUT @Ld;"RES:TLEV";Res_hipt
1350  END IF
1360  OUTPUT @Ld;"*TRG"
1370  INPUT "Enter voltage across input terminals in volts",Tran_volt
1380  INPUT "Enter current through current shunt in amps",Tran_curr
1390  Tran_res=Tran_volt/Tran_curr
1400  OUTPUT @Ld;"CAL:TLEV";Tran_res
1410  OUTPUT @Ld;"TRAN OFF"
1420  PRINT "Test unit to verify transient values are in spec"
1430  PRINT "Press CONT when ready to end program or calibrate next range"
1440  PAUSE
1450  SUBEND
```

Explanation

LINE 10-20	Specify select code, address, and channel (default 705, 1)
LINE 30	Turn calibration mode on
LINE 40-90	Assign variables for subprograms (see module calibration tables)
LINE 100	Store new constants in EEROM when calibration complete
LINE 110	Turn calibration mode off
LINE 140	Current calibration subroutine
LINE 200-220	Select channel, current mode, and range
LINE 230	Set high calibration point
LINE 240	If high current range, wait for internal current shunt to stabilize
LINE 260	Send measurement in amperes for high main calibration point
LINE 270	If high current range, send measurement in amperes for high readback cal point
LINE 280	Set low calibration point
LINE 300	Send measurement in amperes for low main calibration point
LINE 310	If high current range, send measurement in amperes for low readback cal point
LINE 350	Set low calibration point
LINE 360-370	Select transient toggle mode and GPIB trigger source
LINE 380-390	Turn transient mode on and set transient calibration point
LINE 400	Trigger transient level
LINE 410	If high current range, wait for internal current shunt to stabilize
LINE 430	Send measurement in amperes for high transient calibration point
LINE 440	Turn transient mode off
LINE 500	Voltage calibration subroutine
LINE 550-560	Select channel and voltage mode
LINE 570	Set high calibration point
LINE 590	Send measurement in volts for high main calibration point
LINE 600	Send measurement in volts for high readback calibration point
LINE 610	Set low calibration point
LINE 630	Send measurement in volts for low main calibration point
LINE 640	Send measurement in volts for low readback calibration point
LINE 680	Set low calibration point
LINE 690-700	Select transient toggle mode and GPIB trigger source
LINE 710-720	Turn transient mode on and set transient calibration point
LINE 730	Trigger transient level
LINE 750	Send measurement in volts for transient calibration point
LINE 760	Turn transient mode off
LINE 820	Resistance calibration subroutine
LINE 870-890	Select channel, resistance mode, and range
LINE 900	Set high calibration point
LINE 930-940	Calculate and send measurement in ohms for high main calibration point
LINE 950	Set low calibration point
LINE 980-990	Calculate and send measurement in ohms for low main calibration point
LINE 1030-1070	If middle and high range, set high calibration point; otherwise set low point
LINE 1080-1090	Select transient toggle mode and GPIB trigger source
LINE 1100	Turn transient mode on
LINE 1110-1150	If middle and high range, set lower transient point; otherwise set higher point
LINE 1160	Trigger transient level
LINE 1190-1200	Calculate and send measurement in ohms for transient calibration point
LINE 1210	Turn transient mode off

Considerations For Operating In Constant Resistance Mode

The Agilent Electronic Loads implement Constant Resistance. (CR) mode by using either the CV circuits or CC circuits to regulate the input. The low range is regulated with the CV circuits, using the input current monitor as the reference. Therefore, resistance is described by the formula

$$\frac{V}{I} = R$$

in which input current I is the reference, and voltage at the input terminals, V, is the parameter controlled to determine the resistance of the load.

The middle and high ranges are regulated with the CC circuits, using the input voltage monitor as the reference. Resistance is described by the formula

$$\frac{I}{V} = \frac{1}{R}$$

in which input voltage V is the reference, and current through the input terminals, I, is the parameter controlled to determine the resistance of the load. The reciprocal of resistance, 1/R, is conductance, G. Therefore, the two highest ranges are best thought of as constant conductance ranges, with the CC circuit used to control conductance. This affects how the specified accuracy offset errors (in siemens or 1/ohms, formerly mhos) relate to programmed values (in ohms).

Any offset voltages in the op amps that comprise the load's regulator circuits become errors at the input terminals of the load. In both CV and CC modes the offset is constant across the specified operating range, and can be accounted for during calibration.

The effects of offsets on CR mode accuracy are specified as plus-or-minus constant values in milliohms (low range) or millisiemens (middle or high ranges), and are less than 1% of full scale. In the two higher ranges of CR mode (the constant conductance ranges), the effect on the programmed resistance value is not linear over the resistance range, because resistance is the reciprocal of conductance. Also, because

$$G = \frac{I}{V}$$

the effect of an offset in current (I) on conductance (G) is greater at low input voltages and less for large input voltages.

The electronic load designs are optimized for high-current applications. Therefore, the effects of offsets are more pronounced at high resistance (very low current) values. This may not represent a problem in typical applications, such as those in which the load is used to test a power supply. For example, a 5-volt power supply being tested at 1 amp will require a load resistance of 5 ohms, which is equivalent to 0.2 siemens. The worst-case offset of + 0.008 siemens produces a resistance of between 4.8 ohms and 5.2 ohms, which represents a 4% error.

By contrast, a 10,000-ohm load connected to a 60-volt power supply will draw only 6 milliamps. Electronic loads are not designed to regulate such small currents.

If large resistances are required, the accuracy can be improved by reading the voltage and current directly from the load, calculating the actual resistance, and then adjusting the programmed value accordingly. This technique is most practical in applications requiring a fixed resistive load.

The following examples illustrate the worst-case error possibilities resulting from op amp offsets. The examples are based on a 300-watt unit having 1 ohm, 1 kilohm, and 10 kilohm ranges. These examples do not include the effects of gain errors on accuracy (specified in percent).

Note Note that typical performance is far better than the worst-case possibilities shown here.

Example 1: 1 Ω range (0.033 Ω to 1 Ω)

The offset error for this range is specified as + 8 milliohms. Therefore, if 1 ohm is programmed, the actual resistance will be

$$1 \Omega + 0.008 \Omega = 0.992 \text{ to } 1.008 \Omega.$$

Similarly, if 0.033 ohms is programmed, the actual resistance will be

$$0.033 \Omega \pm 0.008 \Omega = 0.025 \text{ to } 0.041 \Omega.$$

Example 2: 1 k Ω range: (1 Ω to 1 k Ω , or 1 S to 0.001 S)

Because this range is, in effect, a constant conductance range, offset is specified in siemens (1/ohms). Resistance, however, is programmed in ohms. Therefore, to compute the contribution of offset error to programmed value error, the programmed value must be reciprocated first. The offset is then applied to the programmed value (in siemens) and the result is once again reciprocated.

Note that 1 ohm equals 1 siemen, and 1 kilohm equals 0.001 siemens. Therefore, the conductance (0.001 siemens) at full scale resistance (1 kilohm) is a very small percentage of scale conductance.

If 1 ohm is programmed, the corresponding conductance value is 1 siemen. The actual resistance will be

$$\begin{aligned} 1 \text{ S} \pm 0.008 \text{ S} &= 1.008 \text{ S to } 0.992 \text{ S} \\ &= 0.992 \Omega \text{ to } 1.008 \Omega \end{aligned}$$

If 1 kilohm is programmed, the corresponding conductance value is 0.001 siemens. The actual resistance will be

$$\begin{aligned} 0.001 \text{ S} \pm 0.008 \text{ S} &= 0.009 \text{ S to } -0.007 \text{ S} \\ &= 111 \Omega \text{ to infinite } \Omega \\ &\text{(typically } 900 \text{ to } 1100 \Omega) \end{aligned}$$

The load cannot provide negative current corresponding to negative siemens. Therefore, zero current translates to zero siemens, which corresponds to infinite ohms. Note also that the resistance can be as low as 111 ohms, which is much lower than 1 kilohm. This is because the current offset is large compared to the small current corresponding to 1 kilohm (0.001 siemens). For instance, 0.001 siemens corresponds to 6 milliamps at 6 volts input, and the offset specification of 0.008 siemens corresponds to 48 milliamps at 6 volts input.

Calculations for the 10 kilohm range are similar.

INDEX

A

aliases	21
ampere-capacity	46
annunciators	52
application connections	45

B

binding posts	42
---------------------	----

C

calibration commands	78
calibration equipment	77
calibration example	79
CC mode example	72
change sheets	37
checkout	38
computed power	55
computed power value	55
connector cover	43
constant current (CC) mode	22
constant resistance (CR) mode	24, 89
constant voltage (CV) mode	25
continuous transient operation	26, 73
control connector	34, 43
cooling fan	21, 38
CR mode example	72
CV mode example	72

D

duty cycle	62
------------------	----

E

enter statement	67
error codes	64
extended power limit	35
extended power operation	22
external programming input	34, 44
external trigger	28, 45

F

factory default settings	32, 68
fan speed	21
fault output	44
frequency	63
front panel display	51, 54
function keys	53-54, 55

INDEX (continued)

G

GPIB address	42, 64, 67
GPIB connector	41
GPIB device	67
GPIB interface	22, 67

H

HPSL commands	22, 67, 68
---------------------	------------

I

immediate current level	23
immediate resistance level	24
immediate voltage level	25
input connections	42
Input Off	55
input on/off	31, 55

K

keypad	51
--------------	----

L

LCD display	51, 52
line fuses	39
line switches	51
line voltage	38
local control	22
local sense connections	45

M

main level	24, 55
measurement	30, 69
measurement overload	69
metering mode	51, 55
minimum transition time	29
modes of operation	22
monitor outputs	34, 44

N

nominal power limit	34
nonvolatile memory	32

INDEX (continued)

O

output statement.....	67
overcurrent.....	33, 55
overload condition.....	55
overpower.....	34, 55
overtemperature.....	34, 55
overvoltage.....	33, 55

P

parallel connections.....	46
port on/off.....	35, 44
power cord.....	37
power test.....	40
power-limit curves.....	22
programmable current protection.....	69
protection features.....	32, 55
protection shutdown.....	55
pulse delay.....	27
pulse width.....	27
pulsed transient operation.....	27, 73

Q

query.....	68
questionable status.....	32

R

rack mounting.....	38
reading remote programming errors.....	32
rear panel.....	42
recalling the factory default values.....	64
remote control.....	22
remote sense connection.....	45, 48
remote sensing.....	34
remote state.....	51
resetting latched protection.....	33
reverse voltage.....	34, 55

S

saving and recalling settings.....	32, 64
selftest.....	40
sense switch.....	42, 45
setting CC values.....	57
setting CR values.....	59
setting CV values.....	61
setting the mode of operation.....	57
shorting the input.....	63
slew rate.....	24, 25, 26, 29

INDEX (continued)

software current limit.....	33
status reporting	32, 55
system keys.....	52, 63

T

toggled transient operation	29
transient current level	23
transient operation	26, 62
transient resistance level	25
transient voltage level	26
transition time	29
trigger connector.....	44
triggered current level.....	23
triggered operation.....	29
triggered resistance level	24
triggered voltage level	26

V

voltage fault	55
---------------------	----

W

wake-up settings	65
wire lengths.....	47

Z

zero-volt loading	46
-------------------------	----

Agilent Sales and Support Offices

For more information about Agilent Technologies test and measurement products, applications, services, and for a current sales office listing, visit our web site: <http://www.agilent.com/find/tmdir>

You can also contact one of the following centers and ask for a test and measurement sales representative.

United States:

Agilent Technologies
Test and Measurement Call Center
P.O. Box 4026
Englewood, CO 80155-4026
(tel) 1 800 452 4844

Latin America:

Agilent Technologies
Latin American Region Headquarters
5200 Blue Lagoon Drive, Suite #950
Miami, Florida 33126
U.S.A.
(tel) (305) 267 4245
(fax) (305) 267 4286

Canada:

Agilent Technologies Canada Inc.
5150 Spectrum Way
Mississauga, Ontario
L4W 5G1
(tel) 1 877 894 4414

Australia/New Zealand:

Agilent Technologies Australia Pty Ltd
347 Burwood Highway
Forest Hill, Victoria 3131
(tel) 1-800 629 485 (Australia)
(fax) (61 3) 9272 0749
(tel) 0 800 738 378 (New Zealand)
(fax) (64 4) 802 6881

Europe:

Agilent Technologies
Test & Measurement European Marketing Organisation
P.O. Box 999
1180 AZ Amstelveen
The Netherlands
(tel) (31 20) 547 9999

Asia Pacific:

Agilent Technologies
24/F, Cityplaza One, 1111 King's Road,
Taikoo Shing, Hong Kong
tel: (852)-3197-7777
fax: (852)-2506-9284

Japan:

Agilent Technologies Japan Ltd.
Measurement Assistance Center
9-1, Takakura-Cho, Hachioji-Shi,
Tokyo 192-8510, Japan
(tel) (81) 426 56 7832
(fax) (81) 426 56 7840

Technical data is subject to change.

Manual Updates

The following updates have been made to this manual since the print revision indicated on the title page.

4/15/00

All references to HP have been changed to Agilent.
All references to HP-IB have been changed to GPIB.

9/20/04

The Declaration of Conformity has been updated.

5/27/09

A URL has been added to the declaration page to obtain the latest declaration of conformity.