

Noise Figure Measurement Accuracy: The Y-Factor Method

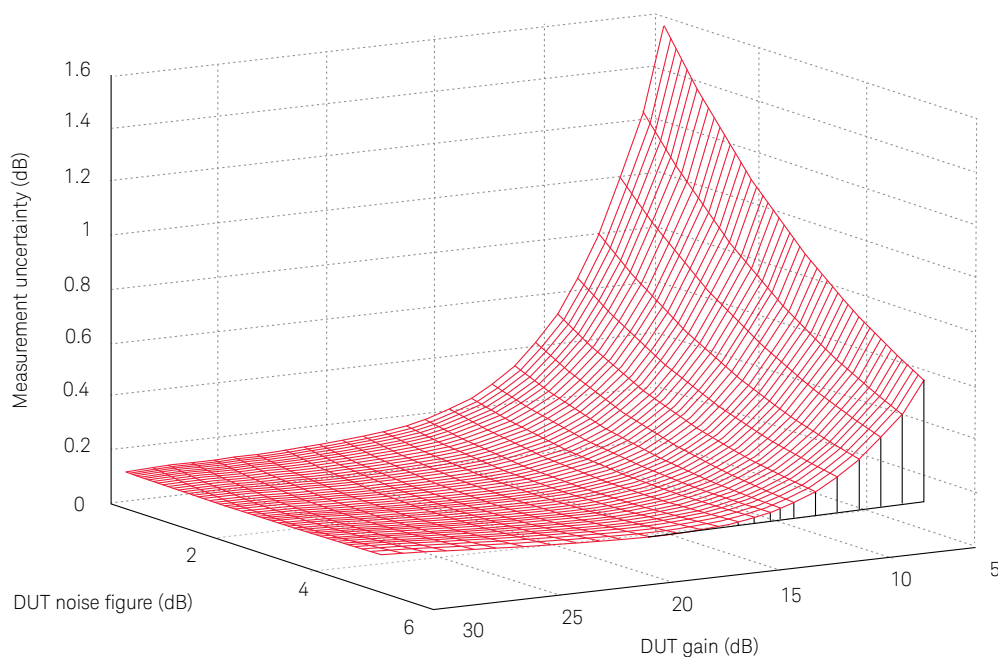

1 Introduction

Why is noise figure important?

Noise figure is a key performance parameter in many RF systems. A low noise figure provides improved signal/noise ratio for analog receivers, and reduces bit error rate in digital receivers. As a parameter in a communications link budget, a lower receiver noise figure allows smaller antennas or lower transmitter power for the same system performance.

In a development laboratory, noise figure measurements are essential to verify new designs and support existing equipment.

In a production environment, low-noise receivers can now be manufactured with minimal need for adjustment. Even so, it is still necessary to measure noise figure to demonstrate that the product meets specifications.

Why is accuracy important?

Accurate noise figure measurements have significant financial benefits. For many products, a guaranteed low noise figure commands a premium price. This income can only be realized, however, if every unit manufactured can be shown to meet its specification.

Every measurement has limits of accuracy. If a premium product has a maximum specified noise figure of 2.0 dB, and the measurement accuracy is ± 0.5 dB, then only units that measure 1.5 dB or lower are marketable. On the other hand, if the accuracy is improved to ± 0.2 dB, all products measuring up to 1.8 dB could be sold at the premium price.

Customers need accurate noise figure measurements to confirm they are getting the performance they have paid for. Using the same example, an accuracy of ± 0.5 dB for measuring a product that a manufacturer has specified as '2.0 dB maximum' would require the acceptance of units measuring as high as 2.5 dB. An improved accuracy of ± 0.2 dB sets the acceptance limit at 2.2 dB.

Speed of measurement is also an issue. High-value products favor accuracy; high-volume products favor speed. Due to the random nature of noise and the statistical aspects of measuring it, there is always a trade-off between speed and accuracy.

To optimize the trade-off, it is necessary to eliminate all avoidable errors and to quantify the uncertainties that remain.

This application note demonstrates how to improve noise figure measurement accuracy by following a three-stage process:

1. Avoid mistakes when making measurements
2. Minimize uncertainties wherever that is possible
3. Quantify the uncertainties that remain

This application note covers the following topics:

- Fundamentals of noise figure measurement using the Y-factor method. (Chapter 2)
- Noise figure mistakes to avoid (Chapter 3)
- Measurement corrections to improve accuracy (Chapter 4)
- Calculation of the remaining uncertainties – including software tools (Chapter 5)
- Other techniques that can reduce uncertainties (Chapter 6)
- Checklist for improving accuracy (Chapter 7).

Keysight's Fundamentals of RF and Microwave Noise Figure Measurements

- *Application Note (5952-8255E)* covers basic concepts behind making noise figure measurements. These basic concepts are expanded on in Chapter 2 of this application note.

This application note is specific to instruments that use the Y-factor method for noise figure measurement. Various features of Keysight Technologies products are mentioned as illustrative examples of the newest generation of noise figure analyzers and noise sources. Other products, however, may be used with the techniques discussed in this document.

2 Noise Figure Measurement

This chapter outlines the fundamental features of the Y-factor measurement technique for noise figure. Many instruments use the Y-factor technique, including:

- Keysight X-Series NFA noise figure analyzers (Figure 1-1)
- Keysight X-Series signal analyzers with noise figure measurement application
- Keysight FieldFox handheld microwave analyzers with noise figure measurements (Figure 1-2)
- Other noise figure analyzers and spectrum analyzers with noise figure measurement personality

The equations developed in this chapter follow the internal calculation route of the Keysight Technologies, Inc. products. The calculation routes of other noise figure instruments that use the Y-factor method are inevitably similar.

This chapter departs from previous explanations of noise figure calculations by making extensive use of the noise temperature concept. Although noise temperature may be less familiar, it gives a truer picture of how the instruments actually work—and most important, how they apply corrections to improve accuracy.

2.1 Fundamentals

2.1.1 What is noise figure?

As explained in *Keysight's Fundamentals of RF and Microwave Noise Figure Measurements*, the fundamental definition of noise figure F is the ratio of:

(signal/noise power ratio at the input of the device under test)

(signal/noise power ratio at the output of the device under test)

Or alternatively:

$$F = \frac{\frac{S_{IN}}{N_{IN}}}{\frac{S_{OUT}}{N_{OUT}}} \quad (\text{Eq. 2-1})$$

(Eq.2-1)



Figure 1-1. Keysight X-Series NFA noise figure analyzers



Figure 1-2. Keysight FieldFox handheld microwave analyzers with noise figure measurements

Noise figure represents the degradation in signal/noise ratio as the signal passes through a device. Since all devices add a finite amount of noise to the signal, F is always greater than 1. Although the quantity F in equation 2-1 has historically been called ‘noise figure’, that name is now more commonly reserved for the quantity NF , expressed in dB:

$$NF = 10 \log_{10} F \text{ [dB]} \quad (\text{Eq.2-2})$$

Keysight Technologies literature follows the contemporary convention that refers to the ratio F as ‘noise factor’, and uses ‘noise figure’ to refer only to the decibel quantity NF .

From the fundamental definition in equation 2-1 a number of useful secondary equations for noise figure can be derived. Equally fundamental is the concept of noise temperature. Many of the internal computations of an automatic noise figure analyzer are carried out in terms of noise temperature, so it is important to understand this concept well (see Section 2.1.2: What is noise temperature?).

Expressed in terms of noise temperature, the noise factor F is given by:

$$F = 1 + \frac{T_e}{T_0} \quad (\text{Eq. 2-3}) \tag{Eq.2-3}$$

T_e is the effective (or equivalent) input noise temperature of the device. Equation 2-3 also introduces a reference temperature T_0 which is defined as 290 K (16.8 °C, 62.2 °F). See “*Fundamentals of RF and Microwave Noise Figure Measurements - Application Note*” (5952-8255E) for details of this derivation. The table below shows a few comparisons between NF , F and T_e .

Noise figure NF	Noise factor F	Noise temperature T_e
0 dB	1	0K (absolute zero)
1 dB	1.26	75.1 K
3.01 dB	2.00	290 K
10 dB	10	2,610 K
20 dB	100	28,710 K

2.1.2 What is noise temperature?

Anyone concerned with noise measurements should thoroughly understand the concepts of noise figure, noise temperature and their relationship.

Any electrical conductor contains electrons which are somewhat free to move around – more so in good conductors, less so in near-insulators. At normal temperatures, electrons are in random motion, although on average there is no net motion unless an electromotive force is applied. This random motion of electrons constitutes a fluctuating alternating current that can be detected as random noise.

At any temperature above absolute zero (where all random motion stops) the thermal noise power generated in a conductor is proportional to its physical temperature on the absolute scale (measured in kelvin, K). Thermal noise is spread evenly over the electromagnetic spectrum (to beyond 5,000 GHz), and therefore the noise power detected by a receiver is proportional to the bandwidth in which the noise is measured.

2.1.2.1 Thermal noise power

The basic relationship between thermal noise power P_N , temperature (T) and bandwidth (B) is:

$$P_N = kTB \quad (\text{Eq.2-4})$$

where

P_N is the noise power (watts)

k is Boltzmann's constant, 1.38×10^{-23} J/K
(joules per kelvin)

B is the bandwidth (hertz)

For example, the thermal noise power generated in a resistor at 290 K (close to room temperature) is $1.38 \times 10^{-23} \times 290 \times B$ watts. This represents a thermal noise power of 4.00×10^{-21} W that is generated in every hertz of the bandwidth B , across the electromagnetic spectrum. P_N is independent of the ohmic value of the resistor. Every circuit component, from near-perfect conductors to near-perfect insulators, generates thermal noise; however, only a tiny fraction of the available noise power is normally detected. This is because the impedances of most individual circuit components are grossly mismatched to typical detection systems.

2.1.2.2 Noise temperature

If a 50Ω resistor at 290 K is connected to the input of a noise-free receiver with a 50Ω input impedance (Figure 2-1), the noise power input to the receiver is:

$$P_N = 1.38 \times 10^{-23} \times 290 \times B \text{ watts} \quad (\text{Eq.2-5})$$

Now imagine a device under test (DUT), such as an amplifier, connected between the 50Ω resistor and the noise-free receiver (Figure 2-2). The noise at the output of the DUT now has two components. One is the amplified thermal noise from the input resistor at 290 K. The second is the noise generated in the DUT itself. Note that the receiver cannot distinguish these two components of noise. To the receiver, the same output noise power density could be measured from a noise-free DUT with its input resistor heated to some higher temperature ($290 + T_e$). In effect the real DUT is modeled as a noise-free equivalent device from which all internal noise sources have been removed. This is combined with an additional thermal noise source T_e at the input. T_e is the effective noise temperature of the DUT (sometimes called the equivalent noise temperature).

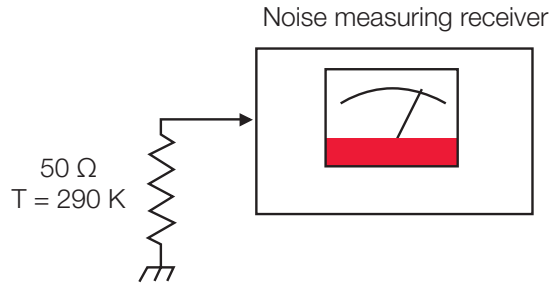

Figure 2-1. A resistor at any temperature above absolute zero will generate thermal noise.

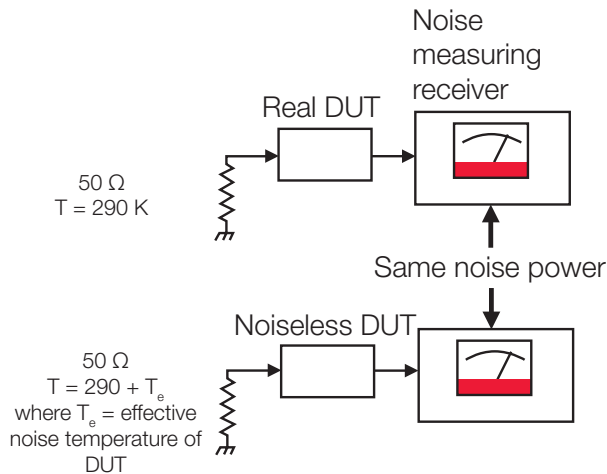

Figure 2-2. Effective noise temperature is the additional temperature of the resistor that would give the same output noise power density as a noiseless DUT.

The advantage of the effective noise temperature concept is that it forms a common basis for measuring random electrical noise from any source, from a GaAsFET to a galaxy. There are many different types of electrical noise, and most of them are not truly thermal in origin. However, all types of random noise can be expressed as the equivalent amount of thermal noise that would be generated at a physical temperature T_e . Generally the word effective (or equivalent) is taken as understood, and the normal term is simply 'noise temperature'.

Since the noise power P_N is directly proportional to temperature T (from equation 2-4), noise temperatures can be added directly in the same way as noise power – provided that the bandwidth (B) does not change.

An example of this is calculating the noise performance of a complete receiving system, including the antenna. As a one-port device that delivers noise power, an antenna has an effective noise temperature T_{ANT} . If the receiver is designed to operate from the source impedance of the antenna (commonly 50 Ω or 75 Ω) T_{ANT} can be added directly to the receiver noise temperature T_{RX} to give the system noise temperature T_{SYS} :

$$T_{SYS} = T_{ANT} + T_{RX} \quad (\text{Eq.2-6})$$

This analysis using noise temperatures provides useful insights into the overall system performance, and can demonstrate whether T_{SYS} is dominated by T_{ANT} (which usually cannot be changed) or by T_{RX} (which often can be improved). Note that such an analysis is not possible using noise figure. This is because the fundamental definition of noise figure cannot apply to a one-port device such as an antenna.

The noise temperature concept also has to be used in the correction of noise figure measurements for resistive losses before or after the device under test (Sections 4.1 and 4.2).

2.1.3 Noise figure in multi-stage systems

The noise figure definition outlined in Section 2.1.1 may be applied to individual components, such as a single transistor, or to complete multi-stage systems such as a receiver.¹ The overall noise figure of the system can be calculated if the individual noise figures and gains of the system components are known.

Figure 2-3 shows how the noise builds up in a two-stage system. The input noise source is shown as a resistor at the reference temperature T_0 (290 K). Each stage is characterized by its bandwidth (B), gain (G) and the noise (N_a) that it adds. The system noise factor F_{12} is then given by:

$$F_{12} = F_1 + \left[\frac{(F_2 - 1)}{G_1} \right] \quad (\text{Eq. 2-7}) \quad (\text{Eq.2-7})$$

See *Fundamentals of RF and Microwave Noise Figure Measurements – Application Note (5952-8255E)* for the detailed derivation.

¹ Note that noise figure of a receiving system can only extend to the receiver input – it does not include the antenna. See “What is noise temperature?” (2.1.2) for explanation.

Notice that the bandwidth (B) has canceled from equation 2-7. This demonstrates one of the advantages of the noise figure and noise temperature concept: it is independent of bandwidth.¹

The quantity $[(F_2 - 1)/G_1]$ in equation 2-7 is often called the second stage contribution. If the first stage gain G_1 is high, that will make the second stage contribution small so that F_{12} will be mostly determined by F_1 alone. This is why a low-noise receiver almost invariably begins with a low-noise, high-gain RF amplifier or preamplifier.

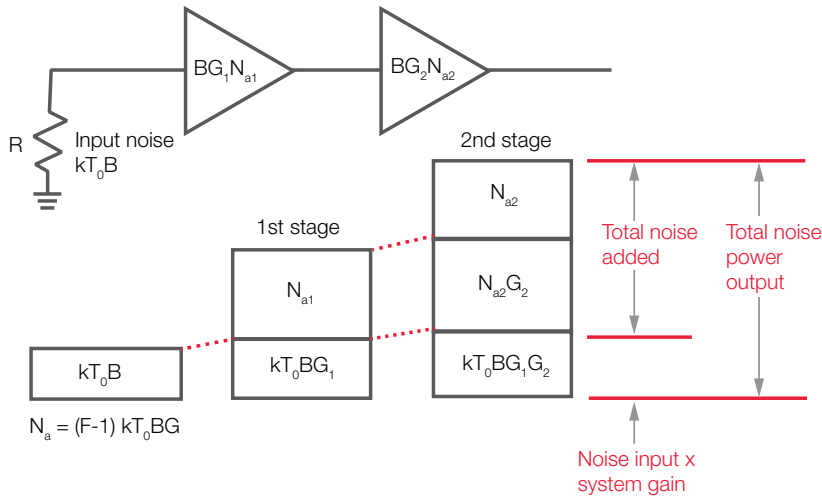

Figure 2-3. How noise builds up in a two-stage system.

Equation 2-7 can be re-written to find F_1 if all the other quantities are known:

$$F_1 = F_{12} - \left[\frac{(F_2 - 1)}{G_1} \right] \quad (\text{Eq. 2-8}) \quad (\text{Eq.2-8})$$

The same equation in terms of noise temperature is:

$$T_1 = T_{12} - \frac{T_2}{G_1} \quad (\text{Eq. 2-9}) \quad (\text{Eq.2-9})$$

Equations 2-8 and 2-9 are the basis for most automatic noise figure analyzers and similar measurement instruments. The device under test (DUT) is always 'Stage 1' and the instrumentation connected to the DUT output is 'Stage 2' (Figure 2-4).

¹ Unless the bandwidth changes within the system being measured (see Section 3.7)

2.2 Y-factor measurement

The Y-factor technique is the most common method of measuring the quantities required by equations 2-8 or 2-9 to calculate the noise factor (F) of the DUT.

This section begins by defining two important quantities: the Excess Noise Ratio (ENR) of a noise source, and the Y-factor itself.

Sections 2.2.3 through 2.2.7 then explain how the complete Y-factor measurement is made.

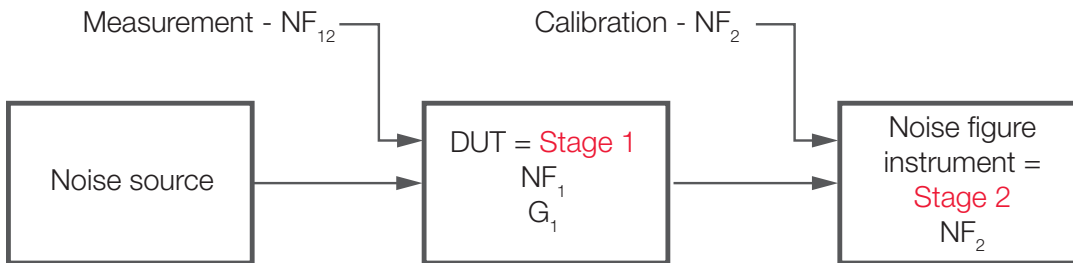

Figure 2-4. Noise figure measurement uses a two-stage system.

2.2.1 Excess Noise Ratio (ENR)

The Y-factor technique involves the use of a noise source that has a pre-calibrated Excess Noise Ratio (ENR). This is defined as:

$$ENR = \frac{(T_s^{ON} - T_s^{OFF})}{T_0} \quad (\text{Eq. 2-10}) \quad (\text{Eq.2-10})$$

or more commonly in decibel terms as:

$$ENR_{dB} = 10 \log_{10} \frac{(T_s^{ON} - T_s^{OFF})}{T_0} \quad (\text{Eq. 2-11}) \quad (\text{Eq.2-11})$$

T_s^{ON} and T_s^{OFF} are the noise temperatures of the noise source in its ON and OFF states. T_0 is the reference temperature of 290 K that appears in the definition of noise figure (equation 2-3).

This definition of ENR supersedes an earlier definition, $ENR = [(T_s^{ON} - T_0) / T_0]$, which implicitly assumed that T_s^{OFF} was always 290 K. The new definition clarifies the fact that T_s^{OFF} and T_0 are usually two different temperatures. Even so, the calibrated ENR of a noise source is always referenced to $T_s^{OFF} = T_0 = 290$ K. Sections 3.10 and 4.4 explain how to correct for the common situation where T_s^{OFF} is higher or lower than the reference temperature.

2.2.2 Y-factor

Y-factor is a ratio of two noise power levels, one measured with the noise source ON and the other with the noise source OFF:

$$Y = \frac{N_2^{ON}}{N_2^{OFF}} \quad (\text{Eq 2-12}) \quad (\text{Eq.2-12})$$

Because noise power is proportional to noise temperature, it can be stated:

$$Y = \frac{T_S^{ON}}{T_S^{OFF}} \quad (\text{Eq 2-13}) \quad (\text{Eq.2-13})$$

The instruments mentioned above are designed to measure Y-factor with the ON measurements very close in time to the OFF measurements, to minimize the effects of drift.

2.2.3 Calibration

The complete Y-factor measurement of DUT noise figure and gain consists of two steps, as shown in Figure 2-5. See section 2.2.3.2 for FieldFox microwave analyzer specific calibration differences.

The first step is called calibration (Figure 2-5a) (or “user calibration” in instruments that have “internal cal” available) and is done without the DUT in place. The noise source is usually connected directly to the input of the instrument.¹

If the noise temperature of the instrument (stage 2) is T_2 then, according to equation (2-12), the Y-factor measured by connecting the noise source directly to its input will be:

$$Y_2 = \frac{N_2^{ON}}{N_2^{OFF}} = \frac{(T_S^{ON} + T_2)}{(T_S^{OFF} + T_2)} \quad (\text{Eq. 2-14}) \quad (\text{Eq.2-14})$$

or

$$T_2 = \frac{(T_S^{ON} - Y_2 T_S^{OFF})}{(Y_2 - 1)} \quad (\text{Eq 2-15}) \quad (\text{Eq.2-15})$$

T_S^{OFF} is the physical temperature of the noise source, and T_S^{ON} is computed from the noise source ENR_{dB} using equation (2-11).

¹ The calibration step is comparable to the normalization step when using a network analyzer – before the DUT is inserted, the instrument first ‘measures itself.’

At the end of calibration, the instrument stores the measured values of N_2^{ON} and N_2^{OFF} , and the computed values of Y_2 and T_2 . It then normalizes its noise figure and gain displays to 0 dB, ready for the next step involving the DUT.

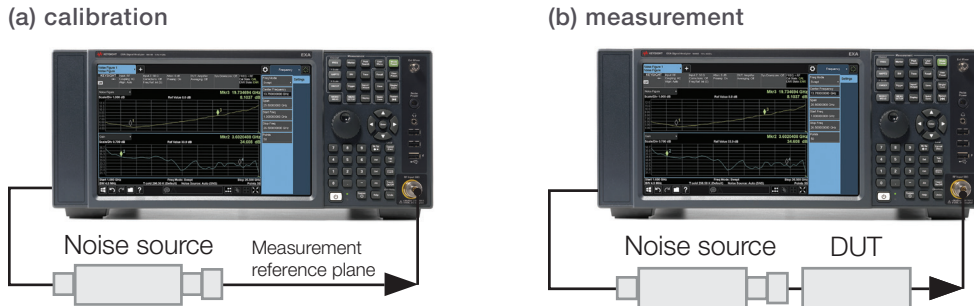

Figure 2-5. The Y-factor noise figure measurement requires two steps: (a) Calibration, (b) Measurement of DUT.

2.2.3.1 Alternatives to calibration

Measurements can be made without calibration for convenience. Generally, this will result in substantially higher errors unless the DUT gain exceeds 30 dB. X-Series NFA noise figure analyzers and X-Series signal analyzers with noise figure measurement application have a feature called “Internal Cal.” This allows the convenience of not performing a calibration, while still substantially reducing the errors due to instrument noise. Generally, Internal Cal will give results that are as accurate as a full calibration when the DUT gain is 15 dB or more.

2.2.3.2 FieldFox microwave analyzer calibration

FieldFox microwave analyzers use the Y-factor measurement technique but employ a slightly varied calibration technique over the X-Series NFA noise figure analyzers and X-Series signal analyzers as described in the preceding sections. The FieldFox noise figure measurement has two types of calibrations: Receiver Cal and User Cal.

a) Receiver Cal

When there is no preamplifier in the measurement, only a receiver calibration is required. The receiver calibration has virtually no influence on the noise figure measurement, either with or without a user calibration. The receiver calibration only effects the gain measurement, and only when there is no user calibration. The receiver calibration measures the measurement bandwidth of the receiver. In most cases, this is set primarily by the digital processing of the receiver. The receiver calibration is needed because it is influenced by the IF analog circuitry of the FieldFox. Additionally, the bandwidth is extremely stable and does not vary significantly with time or temperature. Therefore, once the receiver calibration has been successfully performed there is no need to repeat the receiver calibration, other than with the following exceptions:

1. To re-run the receiver calibration when the FieldFox receiver hardware is changed (factory repair), or
2. In the rare case where a filter is added to the measurement system which has a narrower bandwidth than the receiver (i.e., the external bandwidth is less than the lowest resolution bandwidth (Res BW) setting of 300 kHz).

(B) User Cal

It is important to note that FieldFox microwave analyzers have a unique “User Cal” definition that is not equivalent to the term “user calibration” as defined in the previous Section 2.2.3. In general, a “User Cal” should be performed on FieldFox whenever a preamplifier is used in the noise figure measurement. If there is no preamplifier, the user calibration is not necessary. Although it will be interpolated if other frequencies are used, when a user calibration is performed, it should be made at the same frequencies as the measurement. The user calibration also needs to be performed with the same resolution bandwidth as is used in the measurement. The user calibration determines the noise contribution of the preamplifier, so that it can be removed from the measurement when computing the noise figure of the DUT. Also, the user calibration establishes the power gain of the receiver+preamplifier system so that the reported gain of the DUT will be the gain between input of the DUT (where the noise source is connected during the measurement) and the calibration plane (which is the point where the noise source is connected during the user calibration). Therefore, for the best gain accuracy, the noise source used in the calibration, should be connected at the same point as the DUT will be during the measurement.

2.2.4 Measurement with DUT

Next, the DUT is inserted (Figure 2-5b) and the Y-factor measurement is repeated. The system now comprises the DUT (stage 1) followed by the instrument (stage 2) as shown in Figure 2-4. The combined Y-factor Y_{12} is given by:

$$Y_{12} = \frac{N_{12}^{ON}}{N_{12}^{OFF}} \quad (\text{Eq 2-16}) \quad (\text{Eq.2-16})$$

Following equation (2-15), the combined noise temperature T_{12} of the DUT followed by the instrument is given by:

$$T_{12} = \frac{(T_S^{ON} - Y_{12} T_S^{OFF})}{(Y_{12} - 1)} \quad (\text{Eq 2-17}) \quad (\text{Eq.2-17})$$

2.2.5 Calculation of gain

Since the instrument now has values for N_{12}^{ON} and N_{12}^{OFF} as well as the previously stored values for N_2^{ON} and N_2^{OFF} it can compute the gain of the DUT:

$$G_1 = \frac{(N_{12}^{ON} - N_{12}^{OFF})}{(N_2^{ON} - N_2^{OFF})} \quad (\text{Eq. 2-18}) \quad (\text{Eq.2-18})$$

Usually the instrument displays G_1 in dB:

$$G_1 = 10 \log_{10} G_1 \text{ [dB]} \quad (\text{Eq.2-19})$$

2.2.6 Second stage correction

The instrument has now measured T_2 , T_{12} and G_1 . Equation 2-9 has determined that:

$$T_1 = T_{12} - \frac{T_2}{G_1} \quad (\text{Eq. 2-9}) \quad (\text{Eq.2-20})$$

The instrument now has all the information it needs to compute T_1 , the noise temperature of the DUT, corrected for the noise contribution of the instrument itself.

Most automatic (computing) noise figure instruments can display the results in terms of either noise temperature T (in K), noise factor F (ratio) or noise figure NF (in dB). The conversions are made using equations 2-1, 2-2, and 2-3.

2.2.7 Summary

This section has described in some detail the measurements and internal computations carried out by an automatic noise figure instrument that uses the Y-factor method. This information will help in understanding the information covered in the next three chapters:

- Avoidable measurement errors (Chapter 3)
- Loss and temperature corrections (Chapter 4)
- Calculating unavoidable uncertainties (Chapter 5)

3 Avoidable Measurement Errors

This chapter explains:

- Common errors to avoid when making noise figure measurements
- Routine precautions to minimize common errors
- Practical hints

3.1 Prevent interfering signals

As explained in Chapter 2, all noise figure instruments measure a sequence of different RF noise power levels. Any RF interference, either radiated or conducted, will masquerade as noise power and affect measurement accuracy. Interfering RF signals can cause errors of any size in noise figure and gain. Small errors may escape unnoticed unless an operator is alert to the possibility of interference.

Figure 3-1 shows the kinds of stray signals that could be coupled into the signal path and affect the measurement. Fluorescent lights, nearby instruments and computers, two-way radios, cellular telephones, pocket pagers and local TV or radio transmitters can all interfere with accurate noise measurements.

The path by which RF interference enters the measurement system can be either:

- Direct radiation, with voltages and currents being induced by the electrostatic, magnetic or electromagnetic field
- Conduction through signal, power, and control cables

Measurements on receiver components are especially vulnerable to interference from the transmitters they are designed to receive. For example, if testing a cellular telephone receiver, check particularly for interference from cellular phones and base stations nearby. A frequency-swept measurement is more likely to reveal interference than a single-frequency measurement. This is because the sweep often shows clear anomalies at frequencies where interference is present. The interference may also change between sweeps, so that measurements seem to be unstable at certain frequencies only. Once the possibility of interference has been identified, a spectrum analyzer or a receiver can be used to investigate more closely.

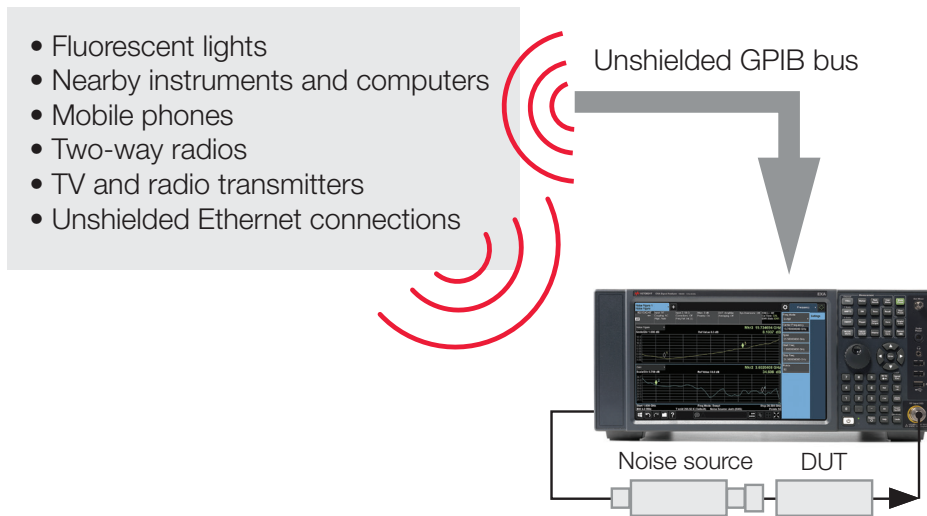

Figure 3-1. Avoid these interference sources that can affect noise figure measurements.

To avoid interference problems, check the following items:

- Use threaded connectors in the signal path whenever possible. (Nonthreaded connectors such as BNC or SMB have lower contact forces on the outer shield, which may affect shielding integrity.)
- Ensure that mating connectors are clean and not worn or damaged. Ensure that readings remain stable when lightly shaking the cables and connectors.
- Use double shielded coaxial cables (some regular coaxial cables have inadequate shielding for these sensitive measurements). Try to avoid using flexible cables at the interface where the signal levels are lowest. If the DUT has gain, connect the noise source directly to its input. If the DUT has loss, connect its output directly to the input of the measurement instrument.
- Avoid making measurements on an open PC breadboard. Use shielding, especially if there is a nearby transmitter that has any output within the measurement bandwidth.
- Relocate the whole setup to a screened room if the DUT and measurement system cannot be shielded adequately on an open bench. It may be necessary to attenuate stray signals as much as 70 to 80 dB.
- Skip over the frequencies of discrete interfering signals when making a swept NF measurement, if the instrumentation and the measurement protocol allow.
- Avoid interference from the instrument itself by using a noise figure analyzer with low RF emissions.¹

3.2 Select the appropriate noise source

Noise sources are available to cover frequencies up to 50 GHz and beyond, with choices of waveguide or co-axial connectors. Most commercial noise sources are supplied with a calibration table of ENR values at specific frequencies.

The ENR calibration uncertainties vary over the frequency range of the noise source, and will contribute to the overall uncertainty in the noise figure measurement – often almost dB-for-dB (see Chapter 5).

For high quality noise sources this uncertainty is about ± 0.1 dB, which is adequate for most purposes. Noise sources can be specially calibrated to reduce this uncertainty. This is not a cost-effective option until all other possibilities for reducing uncertainty have been considered.

¹ Keysight Technologies has designed the noise figure instruments so that RF emissions from the instrument itself can have little or no impact on the *NF* measurement. The instruments are also highly immune to radiated or conducted RF interference – except, of course, through the INPUT port.

3.2.1 Frequency coverage

Use a noise source whose calibration covers the frequency of the measurement.

The ENR of a well designed noise source changes only gradually with frequency, and there are no marked resonances, so linear interpolation between calibrated frequencies is acceptable.

If the DUT is a mixer or other frequency-converting device, the noise source should preferably cover both the input frequency and the output frequency of the DUT. A full-featured noise figure analyzer will select the correct ENR data for the calibration and measurement steps.

If one noise source cannot cover both frequencies, the calibration step and the DUT measurement step must use two different noise sources. The different ENRs must be accounted for. Some automatic noise figure instruments can account for this configuration, but may need to be 'told' when the noise source has been changed.

3.2.2 Identity check

If more than one noise source is available, check that the noise figure instrument is using the correct ENR calibration table.¹

3.2.3 Use low ENR whenever possible

Noise sources are commonly available with nominal ENR values of 15 dB and 6 dB.

Use a 6 dB ENR noise source to measure noise figures up to about 16 to 18 dB, and particularly to minimize measurement uncertainties if:

- The DUT noise figure is very low; and/or the gain of the device is especially sensitive to changes in the noise source impedance.

¹ The latest generation of noise sources, identify themselves to the instrument automatically, and upload their own individual ENR table to the instrument. These noise sources operate with noise figure analyzers such as the X-Series NFA noise figure analyzers and X-Series signal analyzers.

A low ENR noise source has the following advantages:

- If the device noise figure is low enough to be measured with a 6 dB ENR noise source, the noise power levels inside the noise figure instrument will be lower. This reduces potential errors due to instrument nonlinearity (see Section 3.6).
- The impedance match between the noise source and the DUT changes slightly when the source is switched between ON and OFF. The noise output and gain of some active devices (especially GaAsFETs) are particularly sensitive to changes in input impedance. This can cause errors in both gain and noise figure measurement. The 6 dB ENR noise sources contain a built-in attenuator that both reduces the ENR and limits the changes in reflection coefficient between ON and OFF states. Section 3.4.2 gives more details.
- The instrument's own noise figure is a significant contributor to the overall measurement uncertainty (see Chapters 2 and 5). The lower the instrument's internal noise figure, the lower the uncertainty. Many automatic noise figure instruments will insert internal attenuators to handle higher noise input levels. This attenuation will increase the instrument's noise figure. With a low ENR noise source, the instrument will use less internal attenuation, which will minimize this part of the measurement uncertainty.

Avoid overdriving the instrument beyond its calibrated input range when using a 15 dB ENR noise source with a DUT that has very high gain.

A noise figure instrument that is not auto-ranging can be driven into nonlinearity by a DUT with very high gain. This results in the measurement errors described in Section 3.6.1.

Auto-ranging noise figure instruments are less vulnerable to this problem because they automatically insert internal attenuators if necessary. A problem that is commonplace above 40 GHz is that a low ENR noise source might not allow the instrument to self-calibrate on all of its internal attenuation ranges. If the DUT has more than about 40 dB gain, the instrument may have to use higher attenuation ranges that have not been calibrated.¹

In both cases, the solution is still to use the low ENR noise source, but to insert a fixed attenuator after the DUT to reduce its gain. This attenuator must not be included in the calibration loop; it must be accounted for separately (see Section 4.2 for details).

¹ The Keysight X-Series NFA noise figure analyzers and X-Series signal analyzers indicate this condition on the display.

3.2.4 When NOT to use low ENR

Do not use a 6 dB ENR noise source for measurement of noise figures significantly above 16 dB. Use a 15 dB ENR source instead.

When the DUT noise figure is high and the noise source ENR is low, the difference in noise levels between the noise source ON and OFF becomes very small and difficult to measure accurately. This affects the instrument uncertainty ($\delta NF_{\text{Instrument}}$ in Section 5.3, Step 4) in a way that is difficult to quantify. Also, very long averaging times are needed to prevent jitter from making a significant contribution to the overall measuring uncertainty (see Section 3.5).

There is no sharp limit on DUT noise figure where uncertainty suddenly becomes excessive. Accuracy deteriorates progressively with increasing difference between the DUT noise figure and the noise source ENR.

A noise source is suitable for accurate measurement of noise figures up to about (ENR + 10) dB, with increasing care as this level is approached or exceeded. Thus a 6 dB ENR source is generally capable of good accuracy in measuring noise figures up to about 16 dB, and a 15 dB ENR source up to about 25 dB.

If the DUT noise figure is 15 dB above the ENR, or higher, measurement accuracy is likely to be poor.

3.2.5 Avoid adapters

The calibrated ENR of a noise source is quoted at its output connection plane. If it is necessary to use adapters between the noise source and the DUT, a correction must be applied for the adapter losses at the input of the DUT (Section 4.1). Any uncertainty in the value of this correction will contribute dB-for-dB to the overall measurement uncertainty. It is always preferable to obtain a noise source with the correct connector to mate directly to the DUT.

3.3 Use a preamplifier where necessary

This recommendation is closely related to choosing the appropriate noise source. It applies particularly to spectrum analyzers that are used with a noise figure measurement application.¹

This personality can convert a spectrum analyzer into a highly effective noise figure analyzer, except that the instrument noise figure of a spectrum analyzer is significantly higher than that of a modern purpose-built noise figure analyzer. Therefore, if a spectrum analyzer is being used to measure low noise figures using a low ENR noise source, it will generally require the low-noise preamplifier option to minimize measurement uncertainties.

A preamplifier may also be needed with older noise figure meters that have a relatively high instrument noise figure, or with other instruments that can be used to measure noise power level (see *Fundamentals of RF and Microwave Noise Figure Measurements – Application Note [5952-8255E]* for more information about these alternative techniques).

A noise figure analyzer that has a low internal noise figure will not require an external preamplifier unless the DUT has an unfavorable combination of low noise figure and low gain. Section 6.5 will explain how to calculate the uncertainties with or without a preamplifier, and hence how to decide whether the preamplifier is needed.

3.4 Minimize mismatch uncertainties

Mismatch at any interface plane will create reflections of noise power in the measurement path and the calibration path (as shown in Figure 3-2). Mismatch uncertainties will combine vectorially and will contribute to the total measurement uncertainty.

The best measurement technique is to minimize all avoidable mismatch uncertainties, and then use the information in Chapter 5 to account for the uncertainties that remain.

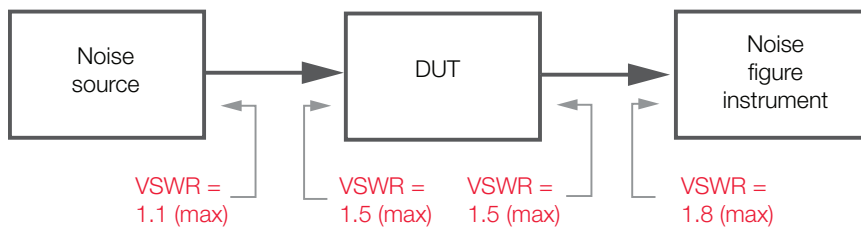

Figure 3-2. Example of mismatch effects.

¹ For example, the Keysight Technologies X-Series spectrum analyzers with noise figure measurement application.

3.4.1 Use an isolator or attenuator pad

An isolator is a one-way device that transmits incident RF power with only a small insertion loss, but absorbs any reflected power in a matched load. Placing an isolator between the noise source and the DUT can prevent reflections from reaching the noise source where they could reflect again and combine with the incident signal. Isolators, however, operate over restricted frequency ranges. A wideband frequency-swept measurement may need to be stopped several times to change isolators, and a continuous frequency sweep will not be possible. Also, each isolator has its own frequency-dependent input/output mismatch and insertion loss. Therefore each isolator must be accurately characterized using a network analyzer, and frequency-dependent corrections applied in the noise figure calculation (see Section 4.1).¹

Another method to reduce mismatch between the noise source and the DUT is to insert a resistive attenuator pad between the two. This has the effect of attenuating reflections each time they pass through the pad. For example, a perfectly matched 10 dB attenuator will have a return loss of 20 dB for reflected signals². Unlike an isolator, a resistive attenuator has the advantage of broadband response. The disadvantage is that an attenuator reduces the ENR of the noise source (as seen by the DUT) by its insertion loss. To avoid ENR uncertainties, the insertion loss of the attenuator must therefore be accurately characterized across the required frequency range, and a correction applied in the noise figure calculation (see Section 4.1).¹

Keysight experience has been that the match of the best attenuators is much better than the match of the best isolators.

Keysight will be publishing a paper on the topic of noise source mismatch on Y-factor noise figure measurements in the millimeter-wave range in 2018, available on a tab in the Excel NF Uncertainty Calculator.

A better alternative, where possible, is to use a low ENR noise source which has a built-in attenuator whose effects are already included in the ENR calibration (see Section 3.2.3). In this case, no loss correction is required.

¹ The Keysight Technologies analyzers with noise figure capability have a loss compensation facility to correct for losses between the noise source and the input of the DUT.

² See section 3.4.3: Measures of mismatch.

3.4.2 Minimize change in ρ of noise source

Some low-noise devices (notably GaAsFETs) have a particularly high input reflection coefficient. Even a small change in the output reflection coefficient of the noise source between its ON and OFF conditions can cause significant errors in the measured noise figure. Even worse, if the input circuit of a low noise amplifier is being adjusted to the minimum noise figure, changes in noise source reflection coefficient can result in a false minimum. To minimize these effects, an attenuator pad or isolator must be used between the noise source and the DUT. Fortunately, low-noise devices are best measured using a low ENR noise source, which already contains a built-in attenuator.

No correction for the change in noise source reflection coefficient is possible without extremely detailed information about the effects of input reflections on the noise and gain performance of the DUT. Usually, the only workable strategy is to minimize the changes.

3.4.3 Measures of mismatch

There are several ways to express how well an RF impedance is matched to the system design impedance (usually $50\ \Omega$ but sometimes some other resistive impedance such as $75\ \Omega$). The four common quantities used are VSWR, reflection coefficient, return loss and the S-parameters S_{11} or S_{22} . RF engineers tend to use these terms interchangeably, depending on the type of device or the network property they wish to emphasize.¹

3.4.3.1 VSWR: voltage standing wave ratio

This relates to the standing wave that is formed on a transmission line by the interaction between the forward and reflected travelling voltage waves. V_{SWR} is literally V_{MAX} / V_{MIN} for the standing wave. At suitable frequencies, V_{SWR} can be measured directly by a slotted-line probe in either a coaxial line or waveguide. Alternatively a bridge or directional coupler can resolve the forward and reflected waves on the line (V_{FWD} and V_{REFL}) and then:

$$VSWR = \frac{V_{FWD} + V_{REFL}}{V_{FWD} - V_{REFL}} \quad (\text{Eq. 3-1}) \quad (\text{Eq.3-1})$$

V_{SWR} is ideally 1 on a matched line, and greater than 1 in practice. V_{SWR} is a scalar quantity – it describes the magnitude of a mismatch but contains no information about the phase.

¹ Please see “*Keysight S-Parameter Design - Application Note*”, dated March 1990 (5952-1087). and “*S-Parameter Techniques for Faster, More Accurate Network Design - Application Note*”, from 1996 (5952-1130).

3.4.3.2 Reflection coefficient

Reflection coefficient ρ (the Greek letter rho) is defined simply as $|V_{REFL} / V_{FWD}|$, so:

$$VSWR = \frac{(1 + \rho)}{(1 - \rho)} \quad \text{or} \quad \text{(Eq.3-2)}$$

$$\rho = \frac{(VSWR - 1)}{(VSWR + 1)} \quad \text{(Eq.3-3)}$$

ρ is a scalar quantity that is ideally zero on a matched line and greater than zero in practice. The quantity (V_{REFL} / V_{FWD}) is the complex reflection coefficient Γ (the Greek capital letter gamma); it is a vector quantity with both magnitude and associated phase angle.

3.4.3.3 Return loss

Return loss is the ratio in dB of forward and reflected power:

$$\begin{aligned} RL_{dB} &= -10 \log_{10} \left(\frac{P_{REFL}}{P_{FWD}} \right) \\ &= -20 \log_{10} \left(\frac{V_{REFL}}{V_{FWD}} \right) \\ &= -20 \log_{10}(\rho) \end{aligned} \quad \text{(Eq.3-4)}$$

The higher the return loss, the better the impedance match. Return loss from an ideally matched line is infinite. A return loss of 0 dB represents total reflection from a complete mismatch. Return loss can either be a scalar quantity or a vector quantity.

3.4.3.4 S-parameters

S (scattering) parameters are a method of describing the behavior of incident and reflected waves at the ports of a network. In a two-port network, S_{11} is the input reflection coefficient and S_{22} is the output reflection coefficient (S_{21} is the forward transfer parameter, and S_{12} describes the reverse transfer). S-parameters are almost invariably measured as vector quantities with both magnitude and an associated phase angle, so S_{11} and S_{22} are complex reflection coefficients like Γ .

3.4.4 Mismatch-related errors

Insertion loss can generally be divided into two parts:

- Dissipative (resistive) loss
- Reflection (mismatch) loss

In noise figure measurements, dissipative mechanisms are recognized as a source of both insertion loss and thermal noise (Sections 4.1-4.3). Reflection mechanisms do not generate thermal noise, but they are a source of uncertainty. This is because scalar measurements of insertion loss and V_{SWR} (or reflection coefficient) cannot predict how the vector reflection coefficients will combine when two imperfectly matched components are connected.

One approach, taken in some network analyzers that also have the capability of noise figure measurement, is to measure the vector mismatches and apply a correction. Unfortunately this is not a full correction because it overlooks an extremely important fact: the mismatch changes the actual noise figure of the DUT. To make a valid correction for mismatch errors, it is necessary to know how the DUT noise figure is affected by a range of complex source and load impedances.

Neither a noise figure analyzer nor a network analyzer with noise figure capability can generate this information on its own. It requires a specialized automated test set that uses stub tuners to present the DUT with a range of complex impedances and incorporates a noise figure analyzer to map the effects on gain and noise figure. As shown in Figure 3-3, a test set can generate a Smith chart showing circular contours of noise figure in the complex impedance. It is important to note that noise figure contours are almost never centered on the $50\ \Omega$ reference impedance at the center of the chart or on the conjugate match to the device input impedance.

Without the complete map of noise figure contours – which cannot be measured by a network analyzer – there is no way to be sure that the correction for a vector impedance mismatch will actually decrease the error of the measurement. The error could even be increased.

It is invalid to attempt mismatch corrections for noise figure measurements made using either a noise figure analyzer or a network analyzer with noise figure capability. Instead, impedance mismatch should be minimized in the design of the measurement, and any residual mismatch should properly be treated as an uncertainty (Chapter 5). Designers of modern noise figure analyzers have concentrated on minimizing all other sources of measurement uncertainty so that the total uncertainty budget can almost always be reduced to acceptably low values.

In uncommon cases where mismatch errors are both unavoidable and significant, the only effective solution requires full mapping of noise figure contours in the complex impedance plane using a test set.

Complete solutions based on the Keysight PNA-X are available.

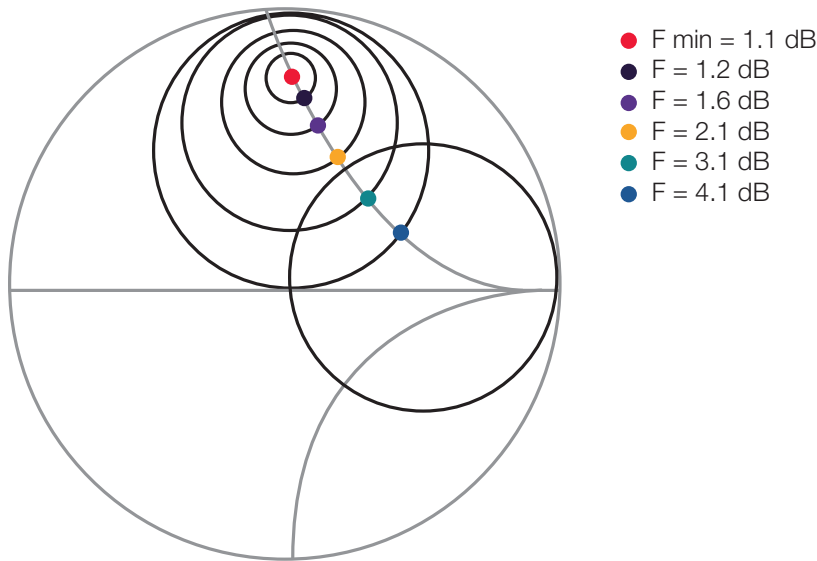

Figure 3-3. The noise figure of most devices depends on the input impedance presented to the device. Without full knowledge of the noise figure contours on a Smith chart, mismatch corrections can be uncertain and may introduce more error.

3.5 Use averaging to reduce display jitter

Noise is a result of a series of random independent electrical events. In principle, the time required to find the true mean noise level would be infinite. Noise measurement captures a finite series of these random events within the measurement bandwidth, and therefore the results inherently display random fluctuations or jitter. Averaging many readings over an extended time period will reduce the displayed jitter, and bring the result closer to the true long-term mean.

There is a trade-off between reduction of jitter and the measurement time required. To obtain a sufficiently accurate result, a suitable number of readings must be averaged. Most computing noise figure instruments have a facility for automatic digital averaging over a selected number of internal readings (N), generally displaying a ‘rolling’ average over the last N readings.

Assuming that the noise being measured has a Gaussian probability distribution, averaging of N readings will decrease the jitter by the square root of N. As shown in the table below, by averaging 10 readings the jitter can be reduced to about 30% of the value for a single reading (see Table 3-1).

As explained in Section 3.7, it is sometimes necessary to make measurements in a reduced bandwidth. In that case, the number of readings averaged must be proportionally increased in order to achieve the same level of jitter. For example, if the bandwidth is reduced from 4 MHz to 100 kHz (a factor of 40), readings must be averaged for 40 times as long to achieve the same level of jitter.

If speed is not the first priority (e.g. in an R&D environment) the instrument should generally be set to average sufficient readings to make the residual jitter a minor component of the overall measurement uncertainty (see Chapter 5). If speed is a high priority (e.g. in a production environment) and the number of readings is low enough to leave a significant uncertainty due to jitter, a jitter contribution must be added to the overall measurement uncertainty.

Jitter in the calibration step will add to the uncertainty of all subsequent measurements. Therefore a long averaging time should be used for calibration in order to reduce this source of uncertainty to a negligible level. This is an efficient use of time because it benefits all subsequent measurements.

Table 3-1. Increased readings reduce uncertainty.

Number of readings averaged	\sqrt{N}	% reduction in jitter	% residual jitter
1	1	0	100
4	2	50.0	50.0
10	3.16	68.4	31.6
16	4	75.0	25.0
64	8	87.5	12.5
100	10	90.0	10.0
256	16	93.75	6.25

In frequency-sweep mode, two modes may be available for updating the display while averaging is taking place.¹ Point averaging takes all the necessary readings for each frequency before averaging them and then moving on to the next frequency. The average at each frequency is not displayed until the measurement at that frequency is complete. 'Trace averaging' takes one reading at each frequency across the whole frequency sweep, and then repeats the whole sweep as many times as necessary, updating the display as it goes. Both modes of averaging give the same result. Trace averaging quickly displays a rough measurement over the entire frequency range. Point averaging is faster overall because the analyzer does not have to change frequency after each reading.

¹ The Keysight noise figure solutions have both averaging modes.

Use trace averaging first. Watch a few sweeps across the display and look for indications of RF interference such as a spike in the response at a single frequency, or even a small step in the response. If there are no problems, change to point averaging for faster measurements.

3.6 Avoid nonlinearity or unstable performance

Accurate noise figure measurements rely on the linearity and stability of the entire measurement system. This includes both the DUT and the noise figure instrument itself.

3.6.1 Nonlinearity

Avoid operating either the DUT or the noise figure instrument in a situation that would cause nonlinear behavior. In particular:

- Do not attempt to measure devices that are specifically designed to be nonlinear, such as logarithmic amplifiers or limiting amplifiers. The techniques described in this application note are not suitable for such devices. Similarly, do not attempt to measure devices that need an input signal in order to operate correctly (e.g. systems that phase-lock to an input signal); these require specialist techniques to measure noise figure.
- Avoid operating the DUT near its saturated output power level where limiting occurs. Accurate measurements require less than 0.05 dB gain difference between the ON and OFF states of the noise source.
- Disable any AGC circuits in the DUT, and take manual control of the gain to establish the required conditions for the measurement. Be aware that AGC-controlled amplifiers may have a limited linear range when operated without AGC. Also, some systems control the gain by techniques that can themselves introduce nonlinearity. If applying a temporary control voltage, do not introduce hum or noise that will modulate the gain.
- Do not attempt to measure circuits that self-oscillate or feed significant levels of local oscillator leakage through to the noise figure instrument; these will cause either RF interference or nonlinearity. Even if far removed from the measurement frequency, all signals of this type should be regarded as RF interference (see Section 3.1) and either suppressed within the DUT or removed by an external filter.
- Use a low ENR noise source whenever the DUT noise figure is low enough to be measured accurately with such a source (see Section 3.2). The noise power levels inside the noise figure instrument will be lower, which reduces potential errors due to instrument nonlinearity.
- Insert in-line attenuation after a DUT with high gain to avoid driving the noise figure instrument beyond its linear range. The instrument specification will indicate the maximum total gain that can be handled between the noise source and the instrument's input. If attenuation is needed after the DUT, it must be accurately characterized using a network analyzer and a correction must be applied in the noise figure calculation (Section 4.2).

- Insert in-line attenuation after a DUT with high gain to avoid driving the noise figure instrument beyond its linear range. The instrument specification will indicate the maximum total gain that can be handled between the noise source and the instrument's input. If attenuation is needed after the DUT, it must be accurately characterized using a network analyzer and a correction must be applied in the noise figure calculation (Section 4.2).¹

3.6.2 Unstable performance

To avoid unstable or drifting performance, use regulated power supplies for the DUT. Allow the DUT and the noise figure instrument to warm up and stabilize before starting measurements.

Consider keeping a 'reference' device that can be measured at the beginning of each day. This will verify that the same result is obtained as on previous days as well as confirm that the measurement instrument is warmed up and has stabilized.

3.7 Choose the appropriate measurement bandwidth

The typical internal bandwidth of a noise figure instrument is 4 MHz. Errors can arise if the DUT contains filters that have a narrower bandwidth than the instrument itself. During calibration the instrument measures the total noise power within its own internal bandwidth. However, during the measurement the bandwidth is restricted by the DUT (see Figure 3-4). This causes an error in the DUT gain measurement, which affects the correction for the instrument's own noise figure (Section 2.2.6).

The error becomes insignificant if the gain of the DUT is high enough to be several orders of magnitude greater than the ratio of the bandwidths during calibration and DUT measurement. The DUT gain criterion is therefore:

$$[G_{\text{DUT, dB}}] \gg \left[10 \log_{10} \left(\frac{B_{\text{CALIBRATION}}}{B_{\text{MEASUREMENT}}} \right) \right] \quad \text{Eq. 3-5} \quad (\text{Eq.3-5})$$

If the DUT gain criterion cannot be met, choose a resolution bandwidth that is significantly less than the bandwidth of the DUT. Take into account the possibility of relative drift between the two passbands during the measurement. Both the calibration and the measurement must use the same bandwidth.

¹ The Keysight Technologies analyzers with noise figure capability have a loss compensation facility to correct for losses between the output of the DUT and the input port of the instrument. As already noted, there is a separate compensation facility for losses between the noise source and the input of the DUT.

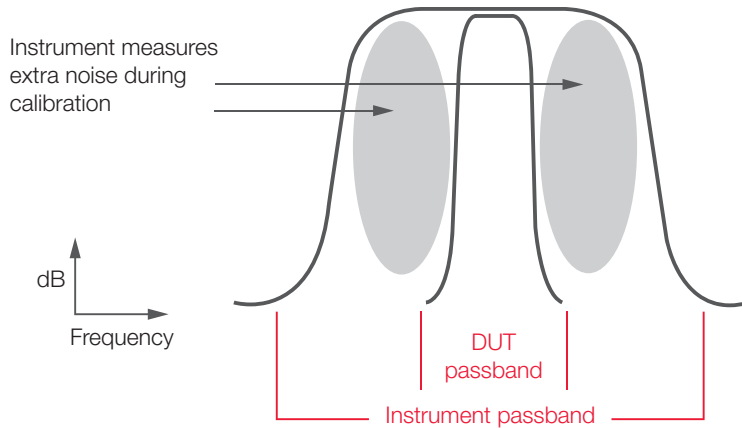

Figure 3-4. A narrowband DUT can cause errors. Use a resolution bandwidth narrower than the bandwidth of the DUT.

3.8 Account for frequency conversion

If the device under test includes a frequency conversion between the input and the output (Figure 3-5) the measurement takes place at a different frequency from the calibration step before the DUT was inserted (Section 2.2). In that case, the following points will need to be carefully considered.

3.8.1 Double sideband or single sideband measurement?

The noise source generates broadband noise. In a double sideband measurement, noise input from both the upper and the lower sideband (USB and LSB) will be converted to the same intermediate frequency (IF), as indicated in Figure 3-6. The noise figure instrument will indicate an average of the USB and LSB responses. If the DUT is designed to accept input signals on both sidebands (e.g. some radio astronomy receivers), then of course a DSB measurement is required.

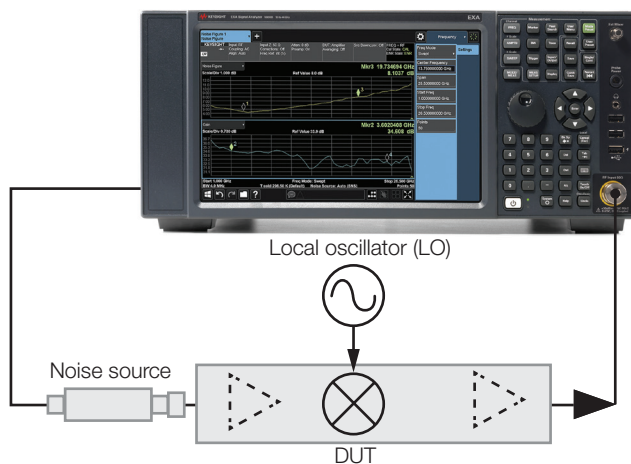

Figure 3-5. Frequency conversion measurement, where the DUT contains a mixer. The local oscillator (LO) may be either internal or external to the DUT.

If the DUT is designed to respond to only one sideband, the noise power input on the unwanted sideband will usually be well suppressed by 'image rejection' filtering within the DUT (Figure 3-7a). As a result the noise figure measurement will be of a single sideband (SSB).

It is sometimes necessary to make an SSB noise figure measurement on a DUT that contains no image rejection filtering. In that case there are two options. One is to insert an external image rejection filter between the noise source and the DUT (Figure 3-7b) and make a correction for the loss in its passband (Section 4.1). The second option is to make a DSB measurement and estimate the SSB noise figure from that.

3.8.2 Estimating SSB noise figure from a DSB measurement

DSB measurements are often seen as easier because they avoid the added burden of image rejection filter design and characterization. In the simplest case, the SSB noise figure will be a factor of 2 (3.0 dB) higher than the DSB measurement. This is only the case when both the ENR of the noise source and the noise figure of the mixer are the same at both the USB and LSB frequencies.

With many types of DUTs (e.g. broadband mixers) the accuracy of this estimate can be improved by lowering the IF at which the measurement is made. This brings the upper and lower sidebands closer together, and minimizes the effect of the frequency difference (compare Figures 3-8 and 3-6).

Before attempting a definitive DSB noise figure measurement that will be converted to SSB, experiment with different IFs to see if frequency variation errors are a problem. If the DSB noise figure values change significantly with the choice of IF, then SSB measurement is recommended.

One practical limit to lowering the IF is the low-frequency limit of the noise figure instrument (typically about 10 MHz for instruments with UHF coverage). Another practical limit is noise sidebands in the local oscillator.

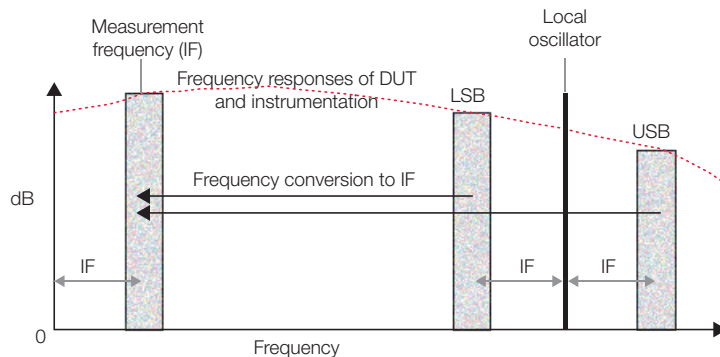

Figure 3-6. A double sideband measurement responds to noise in both sidebands (USB and LSB). Results may be affected by variations in DUT, noise source and instrument performance with frequency.

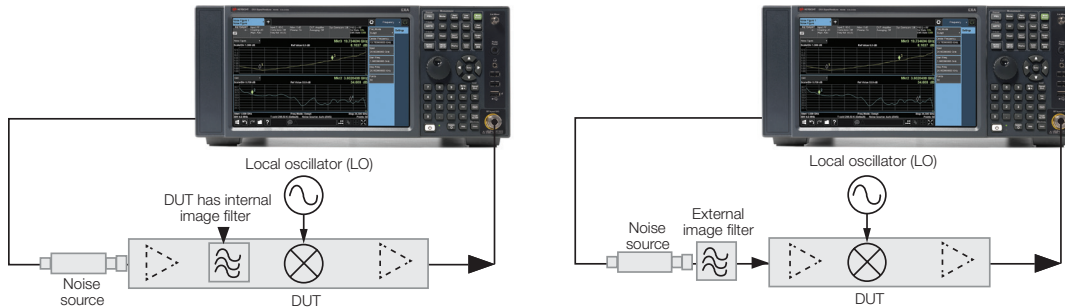

Figure 3-7. Single-sideband noise figure measurements: (a) DUT has internal image rejection filtering. (b) External filter between noise source and DUT.

3.8.3 Local oscillator noise and leakage

No oscillator produces a single, pure frequency. In particular, the LO that is used in a noise figure measurement with frequency conversion will always generate noise sidebands on both sides of the carrier frequency. Typically the noise sideband level reduces with frequency offset from the carrier, eventually reaching an almost constant noise floor level that can be very broadband. As shown in Figure 3-9, high levels of the LO noise sidebands or noise floor may contribute to the measured noise power and may cause erroneous results.

The importance of LO noise entering the noise figure instrument will depend on several factors:

- The noise sideband level (measured in dBc/Hz, i.e. relative to the carrier level and normalized to a 1 Hz bandwidth). The noise sideband power density is a function of:
 - The LO design, and many of its operating parameters, especially level and frequency
 - The IF, which is the offset between the measurement frequency and the LO frequency; the smaller this offset, generally the higher is the noise sideband level
 - The measurement bandwidth
- The broadband noise floor level
- The mixer's LO to IF port isolation. A well-balanced mixer may give a rejection of 30 dB or better for LO noise sidebands, but nonbalanced mixer configurations may have zero LO-IF isolation
- The noise figure and gain of the DUT

As a general rule, the LO noise level at the IF separation from the carrier should not exceed -130 dBm/Hz. More specifically:

[LO power level (dBm) - LO phase noise suppression (dBc/Hz)]

should be well below

$$[-174 \text{ dBm/Hz} + \text{expected NF [dB]} + \text{Gain of DUT [dB]}] \quad (\text{Eq.3-6})$$

Another important factor is the level of LO leakage through the DUT and into the noise figure instrument. As noted in Sections 3.1 and 3.6, this can cause errors by appearing as RF interference and/or by over driving the instrument into an uncalibrated or nonlinear region.

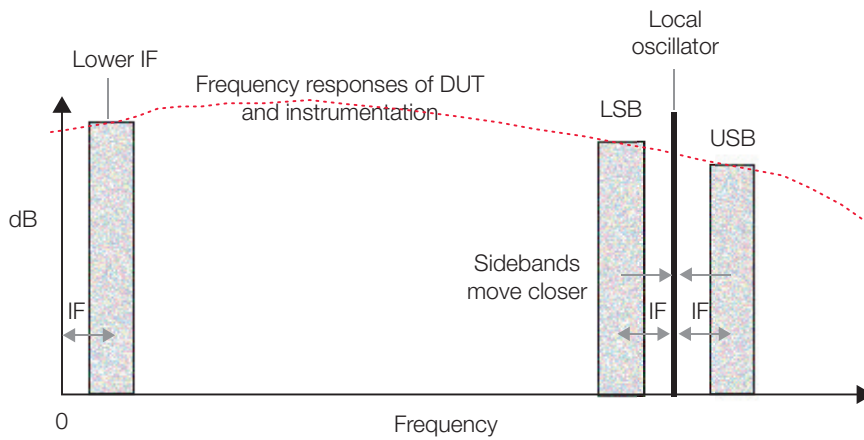

Figure 3-8. Reducing the IF for a DSB measurement can also reduce the effect of differences in noise figure (and/or ENR of noise source) between the LSB and USB. Compare against Figure 3-5.

3.8.4 What to check

When making measurements involving frequency conversion, always check for the causes of error described above. In particular:

- Check whether the apparent DSB noise figure varies with IF frequency
- Check for LO leakage, using a spectrum analyzer at the output of the DUT. Apply filtering if necessary
- Check for the effects of LO noise sidebands
- Apply all relevant corrections mentioned in this chapter for mismatch and losses ahead of and after the DUT. Note that some of these corrections may also be frequency-dependent, and may require close attention in a wideband DSB measurement

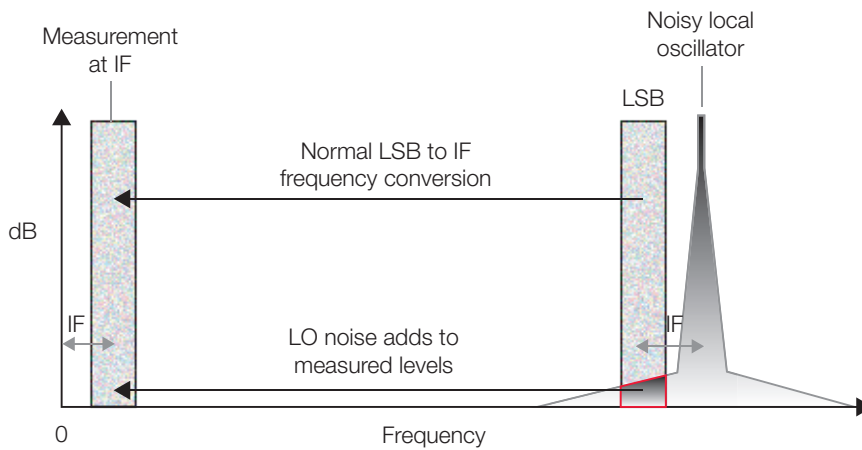

Figure 3-9. In a frequency-converting system, noise sidebands from the LO can affect noise figure measurements.

3.9 Account for any other insertion losses

Previous sections mention several potential sources of loss – both reflective and resistive (dissipative) – before and after the DUT. As a final check before making a definitive measurement, ensure that all relevant losses have been determined.

The calibration step before the measurement will establish the measurement reference plane at the output of the noise source (Figure 2-5a). This automatically takes account of any losses between the output of the DUT and the input of the noise figure instrument. In effect, the losses are ‘absorbed’ into the instrument noise figure NF_2 as explained in Chapter 2.

When the DUT is inserted, the output of the noise source should be connected as directly as possible to the input of the DUT. All components that were included in the calibration loop must still be present between the output of the DUT and the input of the noise figure instrument (Figure 3-10a). If it is necessary to insert components between the noise source and the input of the DUT (Figure 3-10b), these components must not be included in the calibration loop. Their losses must be accounted for separately as shown in Section 4.1.

In many cases it will be necessary to replace the DUT with an equivalent coaxial adapter, which is thus included in the calibration loop. However, as noted in Section 3.2, it is always preferable to use a noise source that has a connector compatible with the input of the DUT, so that the ENR characterization data for the noise source apply exactly at the measurement reference plane. If it is necessary to add or remove an adapter when inserting the DUT into the measurement loop, arrange to do this at the output of the DUT.

If a preamplifier is needed as part of the measurement system (Section 3.3) it should of course be included in the calibration loop. In addition, the input connector of the preamplifier should be compatible with the connector of the noise source in order to establish the correct reference plane. Any necessary adapter should then be placed between the output of the DUT and the input of the preamplifier.

Chapter 4 explains how to correct noise figure measurements for any further losses that have not already been accounted for by the calibration step.

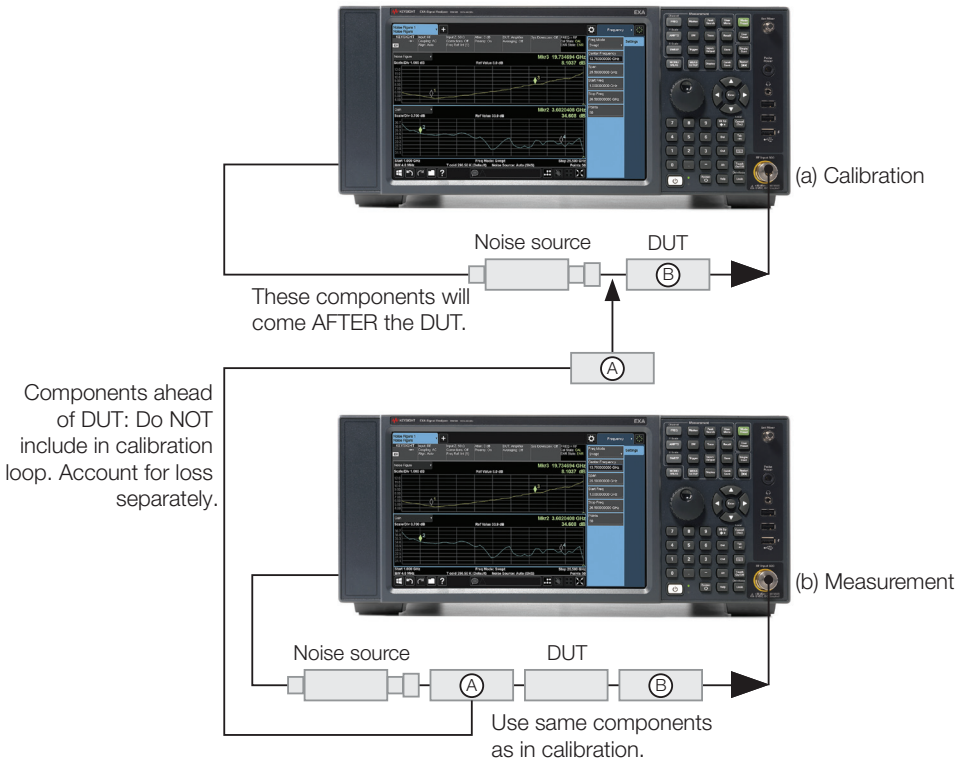

Figure 3-10. Components labeled B that are in the calibration loop (subfigure a) must come after the DUT during the measurement (subfigure b). Components between the noise source and the DUT input (labeled A) must not be included in the calibration loop.

3.10 Correct for physical temperatures

3.10.1 Noise source

Section 2.2.1 defined the ENR of the noise source as:

$$ENR = \frac{T_s^{ON} - T_s^{OFF}}{T_0} \quad (\text{Eq.3-7/2-7})$$

$$ENR_{dB} = 10 \log_{10} ((T_s^{ON} - T_s^{OFF})/T_0) \quad (\text{Eq.3-8/2-8})$$

where T_s^{OFF} is the physical temperature of the noise source (which still emits thermal noise in its OFF condition) and T_0 is the reference temperature of 290 K. The ENR versus frequency tables that characterize each individual noise source are referenced to that temperature; it is assumed that $T_s^{OFF} = T_0$.

If T_s^{OFF} is not 290 K, the ENR will not be correct. This will lead to an error in noise figure as shown in Figure 3-11. The physical temperature of the noise source should then be measured and a temperature correction applied. Most computing noise figure instruments can correct for the actual value of T_s^{OFF} , based on user input from the keypad.¹ (If the value entered is not correct, there will be an error equal to that shown in Figure 3-11.)

For instruments that cannot calculate the correction internally, Section 4.4 describes how to correct the ENR by hand calculation.

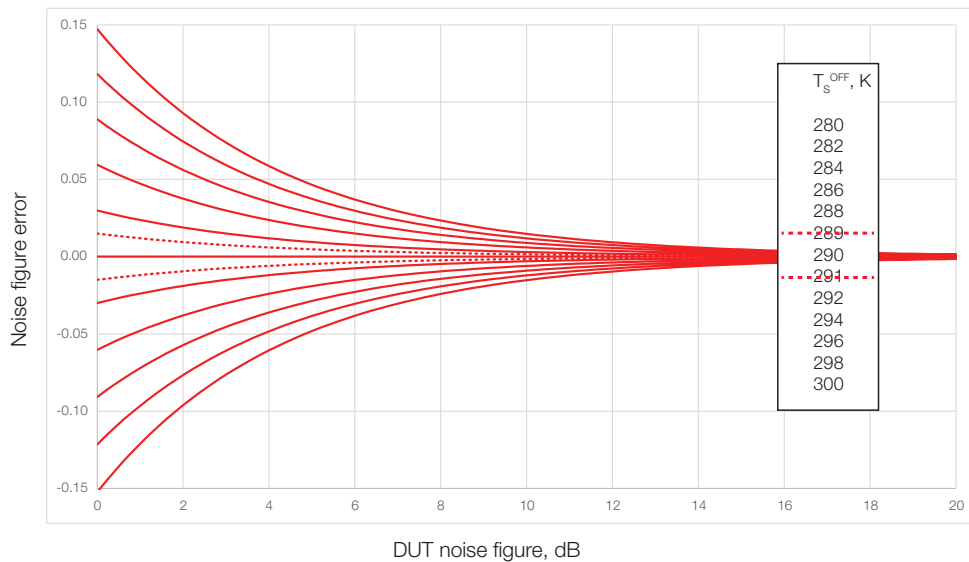

Figure 3-11. Magnitude of error in noise figure measurement if T_s^{OFF} is not 290 K. If the noise figure instrument can correct for the actual value of T_s^{OFF} an equal error arises if the value input to the instrument is not correct.

3.10.2 Noise generated in resistive losses

Any components in the test setup that have resistive losses (attenuators, cables, etc.) will generate thermal noise in their own right. This source of temperature-related error is often overlooked. As well as allowing for the loss itself, a complete correction needs to take account of the noise generation in the components involved. This in turn requires measurement of their physical temperatures. Sections 4.1 and 4.2 show how to make the corrections.

Corrections for physical temperature do not apply to the DUT itself. Its physical temperature is assumed to be part of the DUT test conditions, so the measured noise figure and gain are applicable at that physical temperature.

¹ The latest generation of smart noise sources (SNS) designed for Keysight noise figure analyzers, such as the X-Series NFA noise figure analyzers and X-Series signal analyzers, contain a temperature sensor and the correction is made automatically.

4 Loss and Temperature Corrections

This chapter explains how to make corrections for the residual errors due to losses, either ahead of or following the DUT. Closely related to this is the correction for the physical temperature of the noise source and the temperature of lossy components.

The equations for the corrections are given in terms of noise temperature because that is the parameter most directly affected. For more information on noise temperature, see Chapter 2.

All of the corrections described in this chapter are frequency-dependent. Frequency-swept measurements may need a table of corrections versus frequency. A modern full-featured noise figure analyzer has the capability to make the corrections described in this chapter automatically if it is supplied with frequency-dependent tables of loss data.

4.1 Losses before the DUT

The reference plane for the ENR characterization of the DUT is the output of the noise source (Figure 2-5a). Any additional losses between that reference plane and the input of the DUT must be taken into consideration.

Section 2.2 derived the equation to calculate the noise temperature T_1 of the DUT, with a correction for the ‘second stage’ contribution from the instrument itself (T_2/G_1):

$$T_1 = T_{12} - T_2/G_1 \quad (\text{Eq.3-9/4-1})$$

For this loss correction, the ‘input’ loss L^{IN} needs to be expressed as a ratio greater than 1, so that:

$$L^{IN} = \text{antilog}_{10} \left(\frac{L^{INdB}}{10} \right) \quad (\text{Eq.4-2})$$

The correction for input loss changes the DUT-with-input-loss value of T_{12} to T_{12}^{IN} , and G_1 to G_1^{IN} . If the input loss ahead of the DUT is L^{IN} (as a ratio greater than 1, not dB) then:

$$T_{12}^{IN} = \left[\frac{T_{12}}{L^{IN}} \right] - \left[\frac{(L^{IN}-1)T_L^{IN}}{L^{IN}} \right] \quad (\text{Eq.4-3})$$

$$G_1^{IN} = G_1 L^{IN} \quad (\text{Eq.4-4})$$

where T_{12} , G_1 are the values of system noise temperature and system gain, and T_{12}^{IN} , G_1^{IN} are the new DUT-alone values, corrected for input losses.

Equation 4-3 has two terms. The first represents the direct effect of L^{IN} upon T_{12} . The second term is the added noise contribution from thermal noise in any resistive loss at a physical temperature T_L^{IN} . If L^{IN} is purely reflective (nondissipative) in character, omit the second term.

The corrected values T_{12}^{IN} and G_1^{IN} can be inserted into equation 4-1 to calculate a new value of T_1^{IN} , which is the uncorrected value of T_1 , corrected for input losses:

$$T_1^{IN} = T_{12}^{IN} \left[\frac{T_2}{G_1^{IN}} \right] \quad (\text{Eq.4-5})$$

4.2 Losses after the DUT

As noted in Sections 3-9 and 3-10, correction for losses after the DUT must only be applied to components that had not been included in the calibration loop (Figure 3-10). For output losses the correction is to T_2 , the noise temperature of the instrument (as already modified by components included in the calibration loop).

$$T_2^{OUT} = L^{OUT} T_2 + [(L^{OUT} - 1) T_L^{OUT}] \quad (\text{Eq.4-6})$$

$$G_1^{OUT} = G_1 L^{OUT} \quad (\text{Eq.4-7})$$

As in equation 4-2, L^{OUT} is a ratio greater than 1 and T_L^{OUT} is the physical temperature of any dissipative losses. Once again, if L^{OUT} is purely reflective (nondissipative) in character, omit the second term.

The modified value T_2^{OUT} and G_1^{OUT} can be inserted into equation 4-1 to calculate a new value of T_1^{OUT} , which is the uncorrected value of T_1 , corrected for output losses:

$$T_1^{OUT} = T_{12} \left(\frac{T_2^{OUT}}{G_1^{OUT}} \right) \quad (\text{Eq.4-8})$$

4.3 Combined corrections

The separate corrections for input and output losses can be combined to give $T_1^{IN,OUT}$, the value of T_1 after both corrections have been applied:

$$\begin{aligned}
 T_1^{IN,OUT} &= T_{12}^{IN} - \left[\frac{T_2^{OUT}}{G_1^{IN,OUT}} \right] \\
 &= \left[\frac{T_{12}}{L^{IN}} \right] - \left[(L^{IN} - 1) \frac{T_L^{IN}}{L^{IN}} \right] - \left[\frac{L^{OUT} T_2 + (L^{OUT} - 1) T_L^{OUT}}{G_1^{IN,OUT}} \right]
 \end{aligned}
 \tag{Eq.4-9}$$

where

$$G_1^{IN,OUT} = G_1 L^{IN} L^{OUT} \tag{Eq.4-10}$$

Dedicated noise figure analyzers and noise figure measurement applications for spectrum analyzers can make these corrections when configured with data on before- and after-DUT loss.

4.4 Temperature of noise source

Precision noise sources have an output attenuator to provide a low SWR to minimize mismatch errors in measurements. With this kind of solid-state noise source, T_H will likely be affected by changes in T_C . Because the physical noise source is at a temperature of T_C , the thermal noise due to T_C is added both when the noise source is on and off. Therefore, it is more accurate to assume that the noise change between the on and off state (the excess noise $[T_H - T_C]$), remains constant, than to assume that T_H remains constant, with changes in T_C .

The temperature correction of the noise source may include the following two steps listed.

4.4.1 Temperature at the time of noise source calibration

For noise-diode-based noise sources, the tabulated values of ENR are always referenced to T_0 , not T_C . In other words, ENR is calculated using the following equation at the time of noise source calibration.

$$ENR^{CAL} = \left[\frac{T_H - T_0}{T_0} \right] \tag{Eq.4-11}$$

$$ENR_{dB}^{CAL} = 10 \log_{10} \left[\frac{T_H - T_0}{T_0} \right] \tag{Eq.4-12}$$

where

- ENR^{CAL} , ENR_{dB}^{CAL} are the original calibrated ENR values (ratio or dB, respectively)
- T_H is the hot temperature at the time of noise source calibration
- T_0 is 290 K

However, T_C is not 290 K at the time of noise source calibration. In order to obtain a temperature-independent value of excess noise, the following temperature correction should be applied.

$$ENR^{CORR} = ENR^{CAL} + \left[\frac{T_0 - T_C}{T_0} \right] \quad (\text{Eq.4-13})$$

$$ENR_{dB}^{CORR} = 10 \log_{10} \left\{ \text{antilog}_{10} \left[\frac{ENR_{dB}^{CAL}}{10} \right] + \left[\frac{T_0 - T_C}{T_0} \right] \right\} \quad (\text{Eq.4-14})$$

where

- $ENR^{CORR} = [(T_H - T_C)/T_0]$ is the corrected ENR value, and ENR_{dB}^{CORR} is the corresponding decibel value.
- T_C is the physical temperature at the time of noise source calibration (K).

There are two possible methods to set T_C in this equation:

1. Read it directly from the noise source calibration report, or
2. Use the statistical average value. Specifically, for 18 GHz parts (N4000A and N4001A, 346A and 346B), use $T_C = 302.8\text{K}$; for 26.5 GHz parts (N4002A and 346C), use $T_C = 304.8\text{K}$. Statistical studies show that the error of this process should be negligible compared with the first method.

The first method is rarely feasible, so it is fortunate that the latter works so well.

To understand the challenges with the first method requires an explanation of the calibration process from the NMI (National Metrology Institute) to the final measurement.

In the noise figure business, an NMI calibrates a noise source, such as a Keysight SNS Series noise source, by comparing its noise output level against a primary reference: a hot and a cold resistor pair. As stated above, the NMI references the ENR computation against T_0 , 290 K, not T_C .

The noise source calibrated by the NMI is used as a reference standard for production of new SNS Series noise sources in Keysight. The Keysight process of calibrating new noise sources against a noise source that traces to an NMI means that the appropriate T_c for compensating ENR for the NMI practices is the T_c at the time of calibration at the NMI, not the T_c at the time of calibrating the final noise source against the NMI-supplied reference noise source. The effect of the T_c at the time of calibrating the final customer unit is nominally the same on the reference standard as it is on the noise source to be delivered, which causes the effect to cancel.

Therefore, even though it is the practice of the primary NMI in the noise figure business (the National Physical Laboratory in the United Kingdom) to record the T_c at the time of calibration of their calibrated noise sources on a paper copy of the calibration report, that information is not available to the user of noise sources whose performance is a copy of the NMI noise source performance. That is why the second method of compensation is used in Keysight analyzers.

For the 346 Series at Keysight, the NMI-supplied reference is to create another 346 noise source using our Standards Lab calibration process, and this level of calibrated device is, in turn, used as the reference standard in production. The new 346 Series noise source created with this technique is thus calibrated against a reference that is twice removed from the primary standard. Both of these levels of copying performance serve to maintain the effects of the temperature at which the 346 noise source was calibrated at the NMI. Therefore, the second method of compensation is used for 346 Series noise sources as well with the SNS Series.

4.4.2 Temperature at the time of noise figure measurement

At the time of noise figure measurement, T_S^{OFF} and T_S^{ON} are required for computation of equations 2-15 and 2-17. T_S^{OFF} , the physical temperature at the time of noise figure measurement, may be different from T_c , the physical temperature at the time of noise source calibration. Most computing noise figure instruments can correct for the actual value of T_S^{OFF} , based on user input from the keypad or loaded automatically from the SNS sensor. Since the excess noise remains constant, T_S^{ON} can then be computed as follows.

$$T_S^{ON} = T_0 ENR^{CORR} + T_S^{OFF} \quad (\text{Eq.4-15})$$

5 Calculating Unavoidable Uncertainties

Unavoidable uncertainties are those that remain after all the precautions in the previous chapters have been taken. This chapter describes how the unavoidable uncertainties contribute to the overall measurement uncertainty.

Sections 5.1 through 5.3 give a detailed explanation of uncertainty calculations for an example system. Section 5.4 introduces a spreadsheet calculator to automate the calculation.

5.1 Example system

Figure 5-1 shows the model that is used to illustrate where uncertainties arise in noise figure measurement and how to calculate them. The explanation will use the same basic terms as Chapter 2.

The quantity to be measured is NF_1 , which the instrument indicates as 3.00 dB. The sources of uncertainty in this measurement are:

- The uncertainty of NF_2 as measured in the calibration step (NF_2 is 10 dB for this example, but is normally not displayed)
- The uncertainty of NF_{12} as measured in the DUT measurement step (which also is normally not displayed)
- The impedance mismatch between noise source and instrument, in the calibration step
- The impedance mismatch between noise source and DUT, in the measurement step
- The impedance mismatch between DUT and instrument, in the measurement step
- The uncertainty of the ENR of the noise source.

It is assumed that all other avoidable errors have been minimized (see guidelines in Chapter 3). For example, it is assumed that random jitter has been reduced to a low level by averaging a sufficient number of readings.

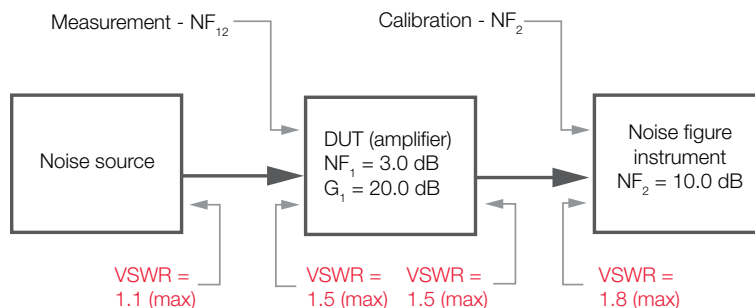

Figure 5-1 Model for uncertainty calculation.

5.2 Example of uncertainty calculation

Uncertainty calculations inevitably involve statistical concepts. This simple example will use RSS (root sum of squares) statistics which assume that all sources of uncertainty are uncorrelated. The equation that will be used to calculate the RSS uncertainty of the noise figure measurement is:

$$\delta NF_1 = \sqrt{\left(\frac{F_{12}}{F_1} \delta NF_{12}\right)^2 + \left(\frac{F_2}{F_1 G_1} \delta NF_2\right)^2 + \left(\frac{F_2 - 1}{F_1 G_1} \delta G_{1,dB}\right)^2 + S \left(\left(\frac{F_{12}}{F_1} - \frac{F_2}{F_1 G_1}\right) \delta ENR\right)^2} \quad (\text{Eq. 5-1/6-1})$$

where

- F_1 is the noise factor of the DUT, as a ratio; NF_1 is the dB quantity
- F_2 is the noise factor of the noise figure instrument, as a ratio; NF_2 is the dB quantity
- F_{12} is the noise factor of the complete system (DUT and instrument), as a ratio; NF_{12} is the dB quantity.
- G_1 is the gain of the DUT, as a ratio; G_1 , dB is the dB quantity
- ENR_{dB} is the Excess Noise Ratio of the noise source, in dB
- The δ terms are the associated uncertainties, always in dB.
- $S = 1$ for a single-frequency measurement;
- $S = 0$ for a measurement involving frequency conversion.

For the derivation of this equation, see Appendix B.

5.3 Step by step

This section works through the uncertainty calculation, step by step. This is usually done by a computer. However, when learning about the process it is valuable to explore the reasoning behind each step.

- Check boxes like this will mark each practical operation. An automatic (computing) noise figure instrument is assumed.

Step 1 – Measurements

- Referring to the user documentation for a noise figure instrument, calibrate the instrument (this will zero the noise figure and gain displays).
- Insert the DUT and measure the DUT gain (G_1) and corrected DUT noise figure (NF_1)
- Determine NF_2 , the noise figure of the instrument. Because the instrument normalizes its noise figure and gain displays to zero after the calibration step, this would not normally be displayed. To gain access to NF_2 , switch off the instrument's auto-ranging with the DUT still in place; this will lock the internal attenuators in their present settings. Remove the DUT and repeat a calibration-type measurement. The instrument will now display its own internal noise figure NF_2 .

Step 2 – Calculate noise figure and gain quantities

- Convert all the dB values into linear equivalents and insert them into the table below:
 - $NF_{12, \text{dB}} \rightarrow$ noise factor F_{12}
 - $NF_{2, \text{dB}} \rightarrow$ noise factor F_2
 - $G_{1, \text{dB}} \rightarrow$ gain ratio G_1
- Also calculate F_{12} as shown in the following table:

Quantity	dB	Ratio = $\text{antilog}_{10}(\text{dB}/10)$
F_1	3	1.995
F_2	10	10
G_1	20	100
$F_{12} = F_1 + (F_2 - 1) / G_1$	3.19	2.085

Calculate the following quantities, for later use in Step 5:

Quantity	Value
F_{12} / F_1	1.045
$F_2 / F_1 G_1$	0.050
$(F_2 - 1) / F_1 G_1$	0.045
$(F_2 - F_1) - (F_2 - F_1 G_1)$	0.995

Step 3 – Calculate mismatch uncertainties

- Convert the maximum *VSWR* at each interface into a reflection coefficient (*r*). Use either measured values or the maximum values quoted in the instrument specifications.

Interface	<i>VSWR</i>	Reflection coefficient $\rho = (VSWR-1) / (VSWR+1)$
Noise source output	1.1	0.048
DUT input	1.5	0.200
DUT output	1.5	0.200
Instrument input	1.8	0.286

- Calculate the various matching uncertainties, based on the reflection coefficients.
- The negative uncertainty is equal to: $-20 \log(1 - \rho_{Source} \rho_{Load})$ dB
- The positive uncertainty is equal to: $+20 \log(1 + \rho_{Source} \rho_{Load})$ dB
- Choose whichever of the two is the greater (underlined).

This process of computing the larger is done for illustration of the concept. The larger will always be the negative uncertainty.

Interface	Negative uncertainty	Positive uncertainty	Maximum uncertainty	Symbol
Noise source to DUT input	<u>0.083</u>	0.082	0.083	δ_{NS-DUT}
Noise source to instrument input	<u>0.119</u>	0.117	0.119	δ_{NS-NFI}
DUT output to instrument input	<u>0.511</u>	0.483	0.511	$\delta_{DUT-NFI}$

Step 4 – Calculate the overall uncertainties

This step requires the maximum matching uncertainties identified above, and the noise figure instrument uncertainties specified by the manufacturer.

The instrument uncertainties are:

- Instrument *NF* (F_2) – for this example, assume $\delta NF_{Instrument} = 0.05$ dB.
- Instrument gain linearity – assume $\delta Gain_{Instrument} = 0.15$ dB.
- ENR of noise source – assume $\delta ENR = 0.1$ dB.

If the calibration and the measurement are at the same frequency, the same δENR applies; the δENR term appears only once, in the main equation 5-1. If the measurement involves a frequency conversion, the δENR at the calibration frequency is separate from the δENR at the measurement frequency; a δENR term appears in each of the equations 5-2, 5-3 and 5-4 below and not in the main equation 5-1.

To simplify this rule, the coefficients S and C are included in equations 5-1 through 5-4:

- Equation 5-1: $S = 1$ for a single-frequency measurement, $S = 0$ for a frequency-conversion measurement.
- Equations 5-2, 5-3 and 5-4: $C = 0$ for a single-frequency measurement, $C = 1$ for a frequency-conversion measurement.

Since this example deals with a single-frequency measurement, $S = 1$ and $C = 0$.

Calculate δNF_{12} [dB]:

$$\begin{aligned}\delta NF_{12} \text{ [dB]} &= \sqrt{(\delta_{NS_DUT})^2 + (\delta NF_{Instrument})^2 + C(\delta ENR)^2} \\ &= \sqrt{0.083^2 + 0.05^2 + 0} \\ &= \underline{0.097}\end{aligned}\tag{Eq.5-2}$$

Calculate δNF_2 [dB]:

$$\begin{aligned}\delta NF_2 \text{ [dB]} &= \sqrt{(\delta_{NS_NFI})^2 + (\delta NF_{Instrument})^2 + C(\delta ENR)^2} \\ &= \sqrt{0.119^2 + 0.05^2 + 0} \\ &= \underline{0.129}\end{aligned}\tag{Eq.5-3}$$

Calculate δG_1 [dB]:

$$\begin{aligned}\delta G_1 \text{ [dB]} &= \sqrt{(\delta_{NS_DUT})^2 + (\delta_{NS_NFI})^2 + (\delta_{DUT_NFI})^2 + (\delta Gain_{Instrument})^2 + C(\delta ENR)^2} \\ &= \sqrt{0.083^2 + 0.119^2 + 0.51^2 + 0.15^2 + 0} \\ &= \underline{0.552}\end{aligned}\tag{Eq.5-4}$$

Step 5 – Calculate uncertainty terms for eq. 5-1

Multiply the ratios found in Step 2 by the appropriate uncertainties.

Term in equation (5-1)	Value [dB]
$(F_{12}/F_1) \times \delta NF_{12}$	0.102
$(F_2/F_1 G_1) \times \delta NF_2$	0.007
$((F_2-1)/(F_1 G_1)) \times \delta G_1$	0.025
$S \times ((F_{12}/F_1) - (F_2/F_1 G_1)) \times \delta ENR$	0.099

Step 6 - Calculate overall uncertainty

There are many ways of calculating the overall uncertainty of a measurement. The conventional Root Sum of Squares (RSS) method will be used here since it is well understood.

RSS should strictly use linear quantities, but with the small dB values that appear in most noise figure uncertainty calculations, the error is only around 0.001 dB.

Insert the appropriate values into equation (5-1). The overall RSS measurement uncertainty is then:

$$\delta NF_{12} = [\text{dB}] = \pm \sqrt{0.102^2 + 0.007^2 + 0.025^2 + 0.099^2} = \pm 0.144 \quad (\text{Eq.5-5})$$

The noise figure of the DUT in this example is therefore 3.00 dB \pm 0.144 dB

The table generated in Step 5 indicates that the δNF_{12} and δENR terms have the most significant influence on the overall uncertainty, followed by the δNF_2 term. Chapter 6 will explore these causes of uncertainty in more detail and explain how they can be minimized.

5.4 Software tools

It is useful to work through the detailed uncertainty calculation in Section 5.3 once, as part of the learning process, but not for everyday application. Keysight Technologies has published a noise figure uncertainty calculator in the form of a Microsoft Excel spreadsheet.¹ The spreadsheet is downloadable from www.keysight.com/find/nfu.

¹ An on-line version of the spreadsheet is also available at the Keysight Technologies web site (www.keysight.com/find/nfu), and the noise figure measurement personality of the X-Series NFA noise figure analyzers and X-Series signal analyzers has a built-in version.

5.4.1 RSS calculations

Figure 5-2 shows the spreadsheet in use for the same RSS uncertainty calculation as detailed in Section 5.3. The uncertainty result is of course the same as in the hand calculation.

Enter the input data in the outlined yellow cells on the spreadsheet. Compare Figures 5-1 and 5-2 to see where to enter each item. In the “Impedance Mismatch” area, the spreadsheet will correctly interpret numerical entries in the form of VSWR ($\check{Z}1$), reflection coefficient (< 1) or return loss (negative, no dB units required).

If the box labeled *Frequency-converting DUT?* is checked, the spreadsheet ensures that the *ENR* uncertainty is applied correctly. This is equivalent to changing coefficients S and C in equations (5-1) through (5-4).

5.4.2 TAG4 calculations

The RSS method of calculation assumes that all the random variables are uncorrelated. This is probably correct, but is normally an unverified assumption. The TAG4 method offers potentially more accurate estimation of uncertainties by calculating and using any correlations that are present. The disadvantage of the TAG4 method is that a full implementation requires data from several sets of readings in order to extract the correlations.

The Keysight Technologies noise figure uncertainty calculator offers a simplified method of TAG4 calculation, using statistically justifiable assumptions to calculate standard uncertainties and covariance when multiple data sets are not available. In most cases the RSS and simplified TAG4 results will be almost identical – compare Figures 5-2 and 5-3.

The data for the TAG4 calculation are entered in the same way as for the RSS calculation (Figure 5-2). A third tabbed page on the spreadsheet gives the results from both methods from the same set of input data.

Keysight Technologies will continue to develop methods of uncertainty calculation for noise figure methods, so it is advisable to check the web site periodically.

5.5 Effects of loss corrections on uncertainty

The loss corrections described in Chapter 4 will introduce further uncertainties of their own.

The uncertainty in correcting for the input loss L^{IN} (Section 4.1) will add directly to δENR , the calibration uncertainty of the noise source. The uncertainty in correcting for the output loss L^{OUT} (Section 4.2) will add directly to the gain uncertainty δG , and also to the instrument noise figure uncertainty δNF_2 . If the DUT has significant gain, both of these terms will be small.

5.6 Other uncertainties

There are other uncertainties that are not included in the analysis so far.

One is the uncertainty of the cold temperature of the noise source. This might be the uncertainty with which the user estimates the temperature, or that with which the SNS noise source measures the temperature. The latter is characterized in the Operating and Service Guide for the noise sources. Analysis shows this error for the SNS is negligible when statistically combined with the other error sources for even the best possible measurements. When using noise sources other than the SNS Series, this error source can be significant, especially when the DUT input connector temperature is very different from the ambient temperature.

A second uncertainty is the interpolation of ENR between the calibration points provided. Analysis of one example noise source showed this error to have a standard deviation of 0.0057 dB RMS. When combined statistically with other uncertainties, this is a negligible contributor.

A third uncertainty is the difference in the DUT gain between the hot and cold measurements due to changes in the match at the noise source output. This difference incorrectly affects the computed noise figure. The mathematics and measurements for this issue are beyond the scope of this application note. But the low ENR noise sources (346A and N4000A) are recommended for handling this situation by virtue of having very low differences in reflection coefficient (less than 0.01) between the hot and cold states.

A fourth uncertainty is the difference between the ENR at the calibration temperature and at the operation temperature. This error will not be significant in general when the ambient temperature is kept close to the ambient temperature used in noise source calibration processes, 23 °C. When the DUT is at a significantly different temperature, that temperature will likely conduct through the DUT-to-noise-source thermal and electrical connection to affect the ENR calibration.

Analysis of an example noise source showed this uncertainty to have a consistent temperature coefficient of +0.0043 dB/K, which agrees with theory for the reverse voltage of the diode used. Because this is not a Gaussian distributed random variable, it is not simple to handle. But Keysight would recommend the following process as being a good approximation for temperatures within $\pm 15^\circ$ of 23 °C: Multiply this temperature coefficient by the difference in temperature between the noise source and 23 °C, and root-sum-square that result with the other uncertainties.



Figure 5-2. X-Series NFA noise figure analyzers and X-Series signal analyzers with noise figure measurement application have a built-in uncertainty calculator with graphical results that can auto-populate instrument, preamplifier and noise source parameters.

Noise Figure Measurement Uncertainty Calculator				
© Keysight Technologies, Inc. 1999, 2012, 2015-6				
		Differences from legacy calculator	Other NFUCs	
			Specification	Styl. Distribution
Device Under Test	DUT NF, NF1	2.831 dB	Fixed	
	DUT Gain, G1	24.392 dB	Fixed	
	DUT Input Match*	1.5 VSWR	Fixed	Fixed
	DUT Output Match*	0.24 reflection	Fixed	Fixed
	Freq Converting DUT?	Non-con'ving (e.g. Amplifier, Attenuator)		
Noise Source	ENR Uncertainty	0.116 dB	95th %ile (2σ)	Gaussian
	Noise Source Match*	0.053 reflection (Maximum)		Rayleigh
Instrument	Instrument Noise Fig	26.2 dB	Fixed	
	Instrument Uncertainty for NF	0.025 dB	Maximum (3σ)	Gaussian
	Instrument Uncertainty for Gain	0.15 dB	Maximum (3σ)	Gaussian
	Input Match*	1.52 VSWR	95th %ile	Rayleigh
	NFE Improvement/Int Cal	9 dB	95th %ile (2σ)	Gaussian
External Preamp	Configuration	In use		
	Noise Figure, Preamp Alone	5.076 dB	Fixed	
	Gain	20.665 dB	Fixed	
	Input Match*	-22.411 Return Loss	Fixed	Fixed
	NFE Improvement/Int Cal	9 dB	95th %ile (2σ)	Gaussian
* Match terms may be entered as the return loss (RL) in dB (Sxx), or VSWR, or as a reflection coefficient, ρ. Example: RL = -15 dB is equivalent to VSWR = 1.43 is equivalent to ρ = 0.178. For a perfect match, enter 1 for VSWR = 1; for a total reflection, enter 0 for RL = 0 dB.				
Computed Uncertainty	Style:			
	Calibration Used	2σ: Expanded Coverage	Level of Confidence	
	Normal (User Cal)	Uncertainty Factor, k		
	Internal Cal	±0.129 dB	2	≈95%
	Uncalibrated	±0.149 dB	2	≈95%

Figure 5-3. An alternative manner to obtain the result would be to utilize the noise figure spreadsheet calculator. Using the same data as Figure 5-2 both methods provide the same results, and can be found at <http://www.keysight.com/find/nfu>. The difference being that the built-in noise figure uncertainty calculator can be used to provide graphic results allowing a number of the modeled parameters to be swept, while the spreadsheet provides all the information on a single page.

6 Practical Implications

This chapter demonstrates how the unavoidable measurement uncertainties described in Chapter 5 affect the overall uncertainty of measurements. It will also present practical solutions that are available to help minimize those uncertainties.

6.1 Sources of uncertainty

The master equation for RSS uncertainty (equation 5-1/6-1) can be used to analyze the sources of practical uncertainty. There are four terms under the square-root sign:

$$\delta NF_1 = \sqrt{\left(\left(\frac{F_{12}}{F_1}\right) \delta NF_{12}\right)^2 + \left(\frac{F_2}{F_1 G_1}\right) \delta NF_2\right)^2 + \left(\frac{F_2 - 1}{F_1 G_1}\right) \delta G_1 [\text{dB}] + S \left(\left(\frac{F_{12}}{F_1} - \frac{F_2}{F_1 G_1}\right) \delta ENR\right)^2}$$

(Eq.6-1/5-1)

The four terms are:

- The δNF_{12} term, consisting partly of the mismatch uncertainty between the noise source and the DUT, and a contribution from the instrument uncertainty which is usually small (equation 5-2).
- The two middle terms which together represent the ‘second stage’ correction for the instrument’s own noise figure, as detailed in equations 5-3 and 5-4.
- The δENR term which represents noise source ENR uncertainty (equation 5-5).¹

The following sections examine how these terms affect the uncertainty in practical measurements. The spreadsheet calculator (Section 5.4) can be used to verify all the quoted results, and to investigate any other combinations of variables.

¹ This chapter will continue to use the amplifier example from Chapter 5. Therefore $S = 1$ which activates the δENR term in equation 5-1/6-1.

6.2 Instrument noise figure and instrument errors

In cases where the second-stage correction is important, usually because the DUT gain is low, the instrument's own noise figure can make a significant contribution to the overall uncertainty. In equation 5-1/6-1 this appears mostly in the uncertainty term δNF_2 .

Figure 6-1 shows a typical trend of uncertainty increasing with the instrument noise figure (note that the overall uncertainty is shown on an unusual log-decibel scale to expand the detail at lower values). Figure 6-1 uses mostly the default values in the spreadsheet calculator. This means that the minimum possible uncertainty is determined largely by the ENR uncertainty of 0.1 dB, plus combined mismatch uncertainties of about 0.04 dB. The spreadsheet calculator can be used to investigate other combinations of parameter values.

The main conclusion from Figure 6-1 is that a high instrument noise figure can be a significant contribution to the total uncertainty. The solutions to this are either to use an instrument with a lower noise figure, or to reduce the instrument noise figure by means of either an internal or external low-noise preamplifier. There are limits however to the effectiveness of the preamplifier solution.

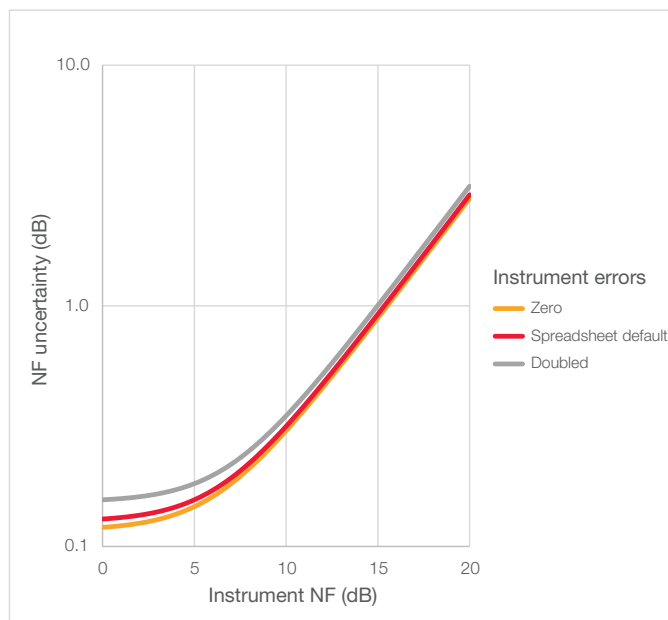

Figure 6-1. Uncertainty versus instrument NF and instrument errors (DUT gain 10 dB, other variables at default values used in spreadsheet).

This will as will be addressed in more detail in Section 6.5. Figure 6-1 shows that the noise figure instrument's own errors are almost always a small part of the total uncertainty. In equation 6-1 these errors appear mostly in the δNF_{12} term. The main sources of instrument errors are:

- In the measurement of noise figure, first during calibration and then when measuring the DUT.
- In the measurement of gain, which is also used in the correction for the instrument noise figure.

The lowest curve in Figure 6-1 represents the idealized case where instrument errors are zero. The curve marked 'Spreadsheet default' is for typical error levels in the NFA instrument (0.05 dB in noise figure, 0.15 dB in gain). Comparing the 'Spreadsheet default' curve against the 'zero errors' curve, the contribution to the total uncertainty is almost negligible. The third curve is for doubled values of those two instrument errors. Even with this pessimistic assumption the contribution to the total uncertainty is small.

6.3 Uncertainty versus DUT noise figure and gain

Figure 6-2 shows how the RSS uncertainty of a typical noise figure measurement depends on the noise figure and gain of the DUT. The data were derived using the noise figure spreadsheet, using the default values for the other parameters.

The 3-D surface in Figure 6-2 has a large region of low uncertainty where the DUT noise figure and gain are both reasonably high. The uncertainty increases when both of these parameters are low. In the most favorable region, the uncertainty is dominated by:

- The δENR term which represents noise source ENR uncertainty equation 5-5.
- The δNF_{12} term in equation 5-1/6-1. Equation 5-2 shows this is partly due to the mismatch uncertainty between the noise source and the DUT, with a generally small contribution from instrument errors.

In the most favorable region of Figure 6-2, the two middle terms in equation 5-1/6-1 are relatively small. Together these two terms represent the 'second stage' correction for the instrument noise figure, as detailed in equations 5-3 and 5-4. This situation represents almost the lowest uncertainty achievable, since it is difficult to improve on the two remaining terms, δNF_{12} and δENR .

If the DUT gain G_r is quite high (e.g. 20 dB), the total uncertainty remains quite low, down to very low values of DUT noise figure. However, if G_r is low, the uncertainty increases dramatically because the second-stage correction grows larger. All the terms in equation 5-1/6-1, especially the δG_r term, will then increase. In extreme cases the uncertainty can even exceed the measured value of noise figure, so these regions are clearly to be avoided.

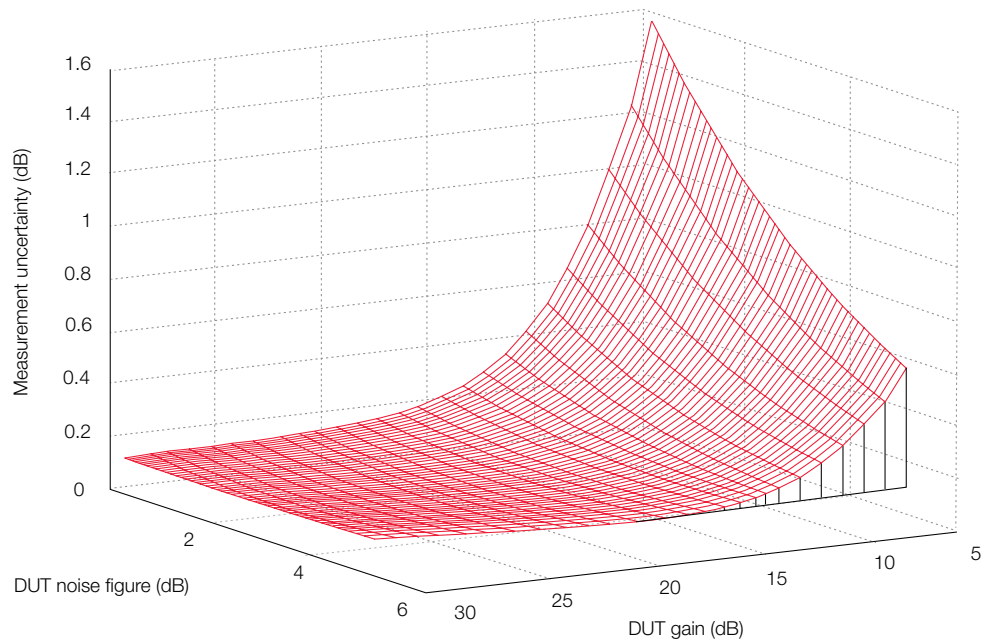

Figure 6-2. 3-D plot of typical RSS uncertainty versus DUT noise figure and gain.

6.4 A possible solution: re-define the DUT

There is sometimes a very simple solution to the problem of low gain in the DUT—change the definition of “what is the DUT”.

For example, if a diode ring mixer (with negative gain) is always followed by an IF preamplifier, uncertainties can be reduced by making the measurement on the combined module rather than the low-gain mixer on its own.

6.5 How to use a preamplifier

Alternatively, a low-noise preamplifier can be inserted at the input of the noise figure instrument, as shown in Figure 6-3. The effect of a preamplifier can be regarded in two different ways. One viewpoint is that it reduces the effective instrument noise figure, which moves down the uncertainty curves of Figure 6-1. The alternative viewpoint is that the preamplifier increases the effective DUT gain, and moves the system down into the more favorable region of Figure 6-2.

6.5.1 When to use a preamplifier

- Spectrum analyzers are primarily designed for high dynamic range rather than low noise.
- A spectrum analyzer with noise figure capability will therefore require a preamplifier in order to produce good quality measurements for the vast majority of applications.
- A low-noise preamplifier may be beneficial if the DUT has low or negative gain and also the noise figure instrument has a high noise figure.

$$F_{2, \text{reduced}} = F_{\text{preamp}} + \left[\frac{F_{2, \text{normal}} - 1}{G_{\text{preamp}}} \right] \quad (\text{Eq.6-2})$$

$$NF_{2, \text{reduced}} = 10 \log_{10} \left\{ \text{antilog}_{10} \left(\frac{NF_{\text{preamp}}}{10} \right) + \frac{\text{antilog}_{10} \left(\frac{NF_{2, \text{normal}}}{10} \right) - 1}{\text{antilog}_{10} \left(\frac{G_{\text{preamp}}}{10} \right)} \right\} [\text{dB}] \quad (\text{Eq.6-3})$$

For example, if using a spectrum analyzer with a specified noise figure of 33 dB, Figure 6-1 shows that this results in unacceptable uncertainties.



Figure 6-3. If the instrument noise figure is high, a low noise preamplifier will reduce the effective instrument noise figure. If the preamplifier is external, ensure it is included in the calibration loop.

A low-noise preamplifier is therefore mandatory for accurate noise figure measurements. A typical system preamplifier for use with this type of instrument¹ has a specified gain of 22 to 27 dB and noise figure of 6.5 dB. According to equation 6-3 it can reduce the effective instrument noise figure to about 12 dB.

¹ For example the Keysight Technologies 87405B.

6.5.2 When not to use a preamplifier

Do not use a preamplifier in the following situations:

- With a modern noise figure analyzer that already has a low instrument noise figure. The instrument noise figure may already be lower than that of preamplifier, so the preamplifier would only make matters worse.
- With a DUT that has significant positive gain. Adding further preamplifier gain will increase the input noise levels. This may drive the instrument into the nonlinear region where the overall measurement uncertainty starts to increase again. Grossly excessive gain in the preamplifier and/or the DUT can also exceed the specified limit for total incident power at the input of the instrument.

6.5.3 How to calibrate the system

If using a preamplifier, it should be included in the calibration loop (in the location of item B in Figure 3-10a). Since the measurement reference plane is at the output of the noise source, the gain and noise figure of the preamplifier are automatically 'absorbed' into the instrument. No further correction is necessary.

6.6 Solutions – reduce ENR uncertainty

ENR uncertainties of most Keysight noise sources are near 0.1 dB. This is adequate for most measurement purposes. But there are opportunities to improve this source of uncertainty.

This section will represent the state of the business in early 2017. The business is in flux, though, so changes are likely. The ENR uncertainty of a noise source traces to an NMI (National Metrology Institute) through a number of generations of calibration until the NMI compares a noise source against a primary reference. Keysight currently uses the British National Physical Laboratory (NPL) as the NMI for both the 346 series and the SNS series.

Keysight achieves superior uncertainty with the SNS devices, about 0.06 dB better at 9 GHz and above and lesser amounts at lower frequencies. So they are recommended for the most critical applications. One of the reasons for this superiority is that new SNS devices are calibrated against a reference that was itself calibrated by NPL against their primary reference. For the 346 series, there is one additional generation of calibration between the primary reference and the final device.

However, field recalibrations of SNS devices are not available to the same two-generations-removed capability. Therefore, for the best ENR uncertainty, you have to replace the noise source every two years.

For the best Y-factor uncertainty, it has been possible to get an SNS noise source calibrated directly against NPL's primary standard. At this time, that can be arranged directly through NPL.

7 Checklist for Improving Measurement Accuracy

- Prevent interfering signals (Section 3.1).
 - Use threaded connectors whenever possible.
 - Ensure that mating connectors are clean, sound and not worn (see Appendix C, Connector care).
 - Lightly shake all cables and connectors, and ensure that readings remain stable.
 - Use double shielded coaxial cables. If the DUT has gain, be sure to connect the noise source directly to its input.
 - Use shielded GP-IB cables to prevent radiation or pickup of interference on the control network.
 - Avoid making measurements on an open PC breadboard.
 - Use a screened room if necessary.
 - If allowable, skip over the frequencies of interfering signals when making a swept NF measurement.
- Select the appropriate noise source (Section 3.2).
 - Check frequency coverage.
 - Confirm correct noise source identity.
 - Use a low ENR noise source whenever possible.
 - Do not use a low ENR source if the DUT noise figure is significantly greater than $(ENR + 10)$ dB.
 - Avoid adapters between the noise source and the DUT.
- Use a preamplifier where necessary (Section 3.3, 6.5).
- Minimize mismatch uncertainties (Section 3.4).
 - Use an isolator or attenuator pad.
 - Minimize change in ρ of noise source.
- Use averaging to avoid display jitter (Section 3.5, 3.7).
- Avoid nonlinearity or unstable performance (Section 3.6).
- Choose the appropriate measurement bandwidth (Section 3.7).
- Account for frequency conversion (Section 3.8).
 - Double sideband or single sideband measurement?
 - Check whether the apparent DSB noise figure varies with IF frequency.
 - Check for LO leakage, using a spectrum analyzer at the output of the DUT. Apply filtering if necessary.
 - Check for the effects of LO noise sidebands.
 - Apply all relevant corrections for losses ahead of and after the DUT. Note that some of these corrections may also be frequency-dependent.
- Account for any other insertion losses (Section 3.9, Chapter 4).
- Correct for physical temperatures (Section 3.10, Chapter 4).

Appendix A: Symbols and Abbreviations

This list includes major symbols only. Other symbols are defined locally where used. For a complete Glossary of terms related to noise figure measurement, see “*Keysight Fundamentals of RF and Microwave Noise Figure Measurements - Application Note*” (5952-8255E).

AGC	Automatic gain control
B	Bandwidth (Hz)
C	‘Switch’ coefficient for dENR; 0 or 1
dB _c	Decibels relative to carrier power
DSB	Double sideband
DUT	Device under test
ENR	Excess noise ratio (power ratio)
ENR _{dB}	Excess noise ratio [dB]
F	Noise factor (power ratio)
F ₁	Noise factor (power ratio) of first stage (DUT)
F ₁₂	Combined noise factor (power ratio) of cascaded first and second stages (DUT and noise figure instrument)
F ₂	Noise factor (ratio) of second stage (often noise figure instrument)
G	Gain (power ratio)
G ₁	Gain (power ratio) of first stage (DUT)
G _{1,dB}	Gain [dB] of first stage (DUT)
K	kelvin (unit of absolute temperature)
k	Boltzmann’s constant, 1.38 x 10 ⁻²³ J/K
L _{IN} / L _{OUT}	Losses before the DUT input/after the DUT output
LO	Local oscillator
N	Noise power
N _{ON} / N _{OFF}	Noise powers measured when noise source is ON/OFF
NF, NF _{dB}	Noise figure [dB]
P	Power
P _N	Noise power
RL _{dB}	Return loss [dB]
RSS	Root sum of squares
S	‘Switch’ coefficient for dENR; 1 or 0
S ₁₁ / S ₂₂	Input/output scattering parameters (reflection coefficients)
SSB	Single sideband
T, T _e	Effective (or equivalent) noise temperature
T ₀	Reference temperature (290 K)
T ₁	Noise temperature of first stage (often DUT)

T_1^{IN}	T_1 corrected for the effects of LIN (uncalibrated losses between the noise source and the input of the DUT)
T_1^{OUT}	T_1 corrected for the effects of LOU (uncalibrated losses between the output of the DUT and the input of the noise figure instrument)
$T_1^{\text{IN, OUT}}$	T_1 corrected for the effects of both LIN and LOU
T_{12}	Combined noise temperature of cascaded first and second stages (DUT and noise figure instrument)
T_2	Noise temperature of second stage (often noise figure instrument)
T_L	Physical temperature of a component with dissipative (resistive) loss
$T_{\text{ON}} / T_{\text{OFF}}$	Noise temperatures measured when noise source is ON/OFF
T_S^{ON}	Noise temperature of noise source in its ON state
T_S^{OFF}	Noise temperature of noise source in its OFF state, equal to its physical temperature
TAG4	ISO statistical method
VSWR	Voltage standing wave ratio
Y	Y-factor: ratio of noise power levels when noise source is ON/OFF
δ terms	Uncertainties associated with the respective quantities [dB] (delta)
Γ	Complex reflection coefficient (capital gamma)
ρ	Scalar reflection coefficient (rho); magnitude of Γ

Appendix B: Derivation of the RSS Uncertainty Equation

The general equation for the noise figure of two cascaded stages is:

$$F_{12} = F_1 + \frac{F_2 - 1}{G_1} \quad (\text{Eq.B-1})$$

We are interested in the uncertainty of F_1 , the noise figure of the DUT, so re-arranging:

$$F_1 = F_{12} - \frac{F_2 - 1}{G_1} \quad (\text{Eq.B-2})$$

Because F_1 is dependent on the three independent variables F_{12} , F_2 and G_1 , Taylor's Theorem can be applied to find the uncertainty of F_1 :

$$\delta F_1 = \frac{\delta F_{12}}{\delta F_{12}} \delta F_{12} + \frac{\delta F_1}{\delta F_2} \delta F_2 + \frac{\delta F_1}{\delta G_1} \delta G_1 \quad (\text{Eq.B-3})$$

From equation 2:

$$\frac{\delta F_1}{\delta F_{12}} = 1 \quad \frac{\delta F_1}{\delta F_2} = \frac{1}{G_1} \quad \frac{\delta F_1}{\delta G_1} = \frac{F_2 - 1}{G_1^2} \quad (\text{Eq.B-4})$$

So:

$$\delta F_1 = \delta F_{12} - \frac{1}{G_1} \delta F_2 + \frac{F_2 - 1}{G_1^2} \delta G_1 \quad (\text{Eq.B-5})$$

What is required is an equation which gives the uncertainty relative to F_1 . To achieve this, all the noise factors (F , ratio) in Equation 5 are first converted into noise figures (NF , dB) and G_1 is likewise converted into dB. The terms in Equation 5 can then be manipulated into the desired form using the following standard differential coefficient for a log quantity:

$$\log_{10} x = \frac{1}{x \log_e 10} = \frac{0.434}{x} \quad (\text{Eq.B-6})$$

Therefore:

$$\begin{aligned} \delta NF_1 &= \frac{4.34}{F_1} \delta F_3 & \delta F_{12} &= \frac{\delta NF_{12} F_{12}}{4.34} \\ \delta F_2 &= \frac{\delta NF_2 F_2}{4.34} & \delta G_1 &= \frac{\delta G_1 [\text{dB}] G_1}{4.34} \end{aligned} \quad (\text{Eq.B-7a, b, c, d})$$

Substituting the above into Equation 4 and simplifying:

$$\delta NF_1 = \frac{F_{12}}{F_1} \delta NF_{12} - \frac{F_2}{F_1 G_1} \delta NF_2 + \frac{F_2 - 1}{F_1 G_1^2} \delta G_1 [\text{dB}] \quad (\text{Eq.B-8})$$

The three δ terms in Equation B-8 are due to the noise figure instrument and the DUT. However, noise figure instruments rely on a calibrated noise source with a specified Excess Noise Ratio (ENR). Clearly there will be an uncertainty associated with this ENR (δENR) and this will contribute to the overall uncertainty equation.

If the calibration and the measurement are at the same frequency, the same δENR applies, so the following term appears in the overall uncertainty equation 9:

$$\left(\frac{F_{12}}{F_1} - \frac{F_2}{F_1 G_1} \right) \delta ENR \quad (\text{Eq.B-9})$$

If the measurement involves a frequency conversion, the δENR at the calibration frequency is separate from the δENR at the measurement frequency. A single δENR term is no longer possible, so a δENR contribution appears in each of the other terms instead. See the main text for further details.

Since the causes of the uncertainties in the four δ terms are different, the terms can be combined in a RSS (Root Sum of Squares) fashion, which gives a realistic overall uncertainty value. The equation for the overall RSS noise figure uncertainty is therefore:

$$\delta NF = \sqrt{\left(\frac{F_{12}}{F_1} \delta NF_{32}\right)^2 + \left(\frac{F_2}{F_1 G_1} \delta NF_2\right)^2 + \left(\frac{F_2 - 1}{F_1 G_1} \delta G_1 [\text{dB}]\right)^2 + \left(\left(\frac{F_{12}}{F_1} - \frac{F_2}{F_1 G_1}\right) \delta ENR\right)^2}$$

(Eq.B-10)

Equation 9 is the source of equations (5-1) and (6-1) in the main text.

Appendix C: Connector Care

Avoid dirt

Even a small amount of dirt on a connector can cause poor contact that will:

- Cause a mismatch
- Attenuate wanted signals
- Invalidate instrument calibration
- Allow interference to enter

It only takes one dirty connector to spread dirt to many others. If there is visible dirt on a connector, clean it with a cotton swab and isopropyl alcohol.

Avoid damage

A damaged connector can cause all the same problems as a dirty one. Likewise, it can spread damage to many other connectors, and the only solution is replacement.

Avoid wear

Connectors do not last forever – they wear, and eventually they wear out. Connectors with worn plating on the mating surfaces of the inner and outer conductors should be replaced before they start to cause intermittent connections or physical damage to other connectors.

With threaded connectors:

- Always mate the threads carefully – take care not to spread thread damage to other connectors
- Never rotate the body of a component to tighten the connector thread – keep the two component bodies still and rotate only the connector nut
- Always use the correct wrench to tighten a connector nut
- Always finish tightening the connector nut with a torque wrench adjusted to the correct value

For further information, see *Principles of Microwave Connector Care (for Higher Reliability and Better Measurements) - Application Note*; literature number 5954-1566.

Learn more at: www.keysight.com

For more information on Keysight Technologies' products, applications or services, please contact your local Keysight office. The complete list is available at: www.keysight.com/find/contactus

