

D9050PCIC

PCI Express 5.0 (Gen5) Electrical Performance Validation and Compliance Software for Z-Series and UXR Series Real-Time Oscilloscopes

Version 0.9

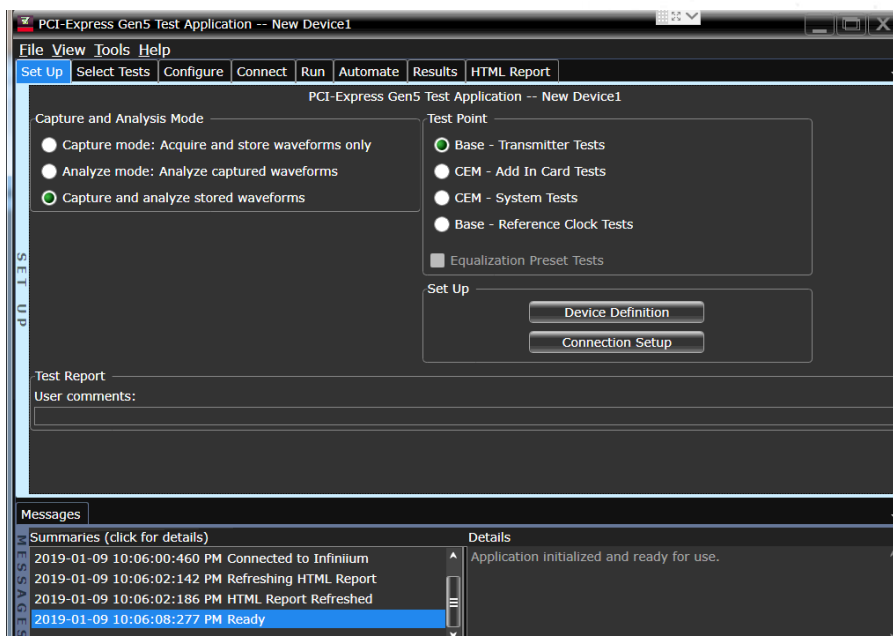

Key Features

The Keysight N9050PCIC PCI Express 5.0 electrical transmitter (TX) test software represents the latest PCI Express TX test tool that supports testing of PCI Express 5.0 devices with speeds of up to 32 GT/s.

Table of Contents

| | |
|---|----|
| Key Features* | 3 |
| Description | 3 |
| PCI Express compliance testing | 4 |
| Benefits | 4 |
| Easy Test Definition | 4 |
| PCI Express 5.0 | 5 |
| Reports with Margin Analysis | 7 |
| Measurement Connection Requirements | 8 |
| Bandwidth Requirements for PCIe 5.0 Tx Testing | 9 |
| Recommended Test Accessories | 9 |
| Ordering Information | 10 |
| Required hardware and software | 10 |
| Flexible Software Licensing and KeysightCare Software Support Subscriptions | 10 |
| Selecting your license | 11 |

Key Features*

The Keysight N9050PCIC PCI Express 5.0 electrical transmitter (TX) test software represents the latest PCI Express TX test tool that supports testing of PCI Express 5.0 devices with speeds of up to 32 GT/s. Below is a list of a few of the key features of this software package.

- Supports Transmitter Testing under the PCIe 5.0 (v0.9) BASE Specification at 32, 16, 8, 5, and 2.5GT/s
- PCIe® 5.0 BASE TX measurements including uncorrelated TJ, DJ, and PWJ, pseudo package loss and other parameters defined in the 0.9 version of the PCI Express BASE specification.
- PCI 5.0 reference clock measurements as defined in v0.9 of the PCIe 5.0 BASE spec.
- Support for de-embedding of test fixtures, high speed switches and cables².
- Supports both real-time data capture as well as off-line analysis of previously captured waveforms
- Test setup wizard for ease-of-use.
- Pass/fail margin analysis
- Support for both full-swing and low-power, half-swing devices
- Supported on Keysight Z-Series and UXR Series real time oscilloscopes having a minimum bandwidth of 50GHz.

Description

The D9050PPCIC PCI Express electrical performance validation and compliance software for PCI Express 5.0 provides you with a fast and easy way to verify and debug your PCI Express 5.0 design for both silicon validation (as per the PCIe® BASE specification) as well as for PCI Express 5.0 add-in cards and motherboard systems (as per the PCIe CEM specification)².

The PCI Express electrical test software allows you to automatically execute PCI Express electrical transmitter tests, and it displays the results in a flexible report format. In addition to the measurement data, the report provides a margin analysis that shows how closely your device passed or failed each test.

The D9050PCIC PCI Express electrical performance validation and compliance software performs a wide range of electrical tests as per the PCI Express PCI Express 5.0 specification only and supports testing transmitters that operate at 32, 16, 8, 5, and 2.5GT/s.

In addition to full swing (800 mV) testing, the software also supports testing for low-power, half-swing devices (400 mV).

*Preliminary document. Features subject to change without notice

1. Requires the purchase of the optional Keysight InfiniiSim Waveform Transformation Toolset for Infiniium oscilloscopes.
2. CEM testing support for PCIe 5.0 not available at introduction and is dependent upon finalization of CEM testing tools and procedures from the PCISIG.

PCI Express compliance testing

To pass signal quality testing at a PCI-SIG-sponsored compliance workshop, your product must successfully pass “Gold Suite” testing, based on the PCI-SIG SigTest application. The SigTest application tests your device against the minimum signal-quality performance requirements for PCI. If you are developing receivers and transmitters for add-in boards and system motherboards, the D9050PCIC PCI Express electrical test software helps you execute the SigTest tests and additional oscilloscope already completed tests.

While SigTest tests provide a good overview of PCI Express electrical signal quality, they address only a small subset of the electrical compliance measurements specified in the PCI-SIG specification. The SigTest application also provides minimal reporting capability with pass/fail indication and measurement values and has limited debugging capabilities to decipher eye mask violations or excessive jitter.

For PCI Express 5.0 measurements, the software automatically calculates uncorrelated total jitter, uncorrelated deterministic jitter, uncorrelated PWJ necessary for validating new PCIe 5.0 compliant chipsets.

Benefits

PCI Express electrical test software benefits

The D9050PCIC PCI Express electrical test software saves you time by setting the stage for automatic execution of PCI Express electrical tests. Part of the difficulty of performing electrical tests for PCI Express is hooking up the oscilloscope, loading the proper setup files, and then analyzing the measured results by comparing them to limits published in the specification. The PCI Express electrical test software does much of this work for you. In addition, if you discover a problem with your device, robust debug tools are available to aid in root-cause analysis. These debug tools are provided by the Keysight high-speed serial data analysis software, which you must install on your oscilloscope to use the PCI Express electrical test software.

The D9050PCIC software also has an integrated interface for controlling the InfiniiSim Waveform Transformation Toolset for de-embedding of test fixtures. Introduced with PCIe 2.0, de-embedding of test fixtures utilizes S-parameters as input to create a de-embed model that helps to restore high frequency signal content that is often lost or significantly attenuated by test

fixtures and cables. This can help to recover significant jitter margin normally lost to fixtures used in a test setup. This helps ensure consistent run-to-run setup of the instrumentation, saving you time and providing consistent and accurate receive test results.

Easy Test Definition

The D9050PCIC PCI Express electrical test software extends the ease-of-use advantages of Keysight's Infiniium oscilloscopes to testing PCI Express designs. The Keysight automated test engine walks you quickly through the steps required to define the tests, set up the tests, perform the tests, and view the test results. You can select a category of tests all at once or specify individual tests. You can save tests and configurations as project files and recall them later for quick testing and review of previous test results. Straightforward menus let you perform tests with a minimum of mouse clicks.

Select one test or a group of tests with a single mouse click

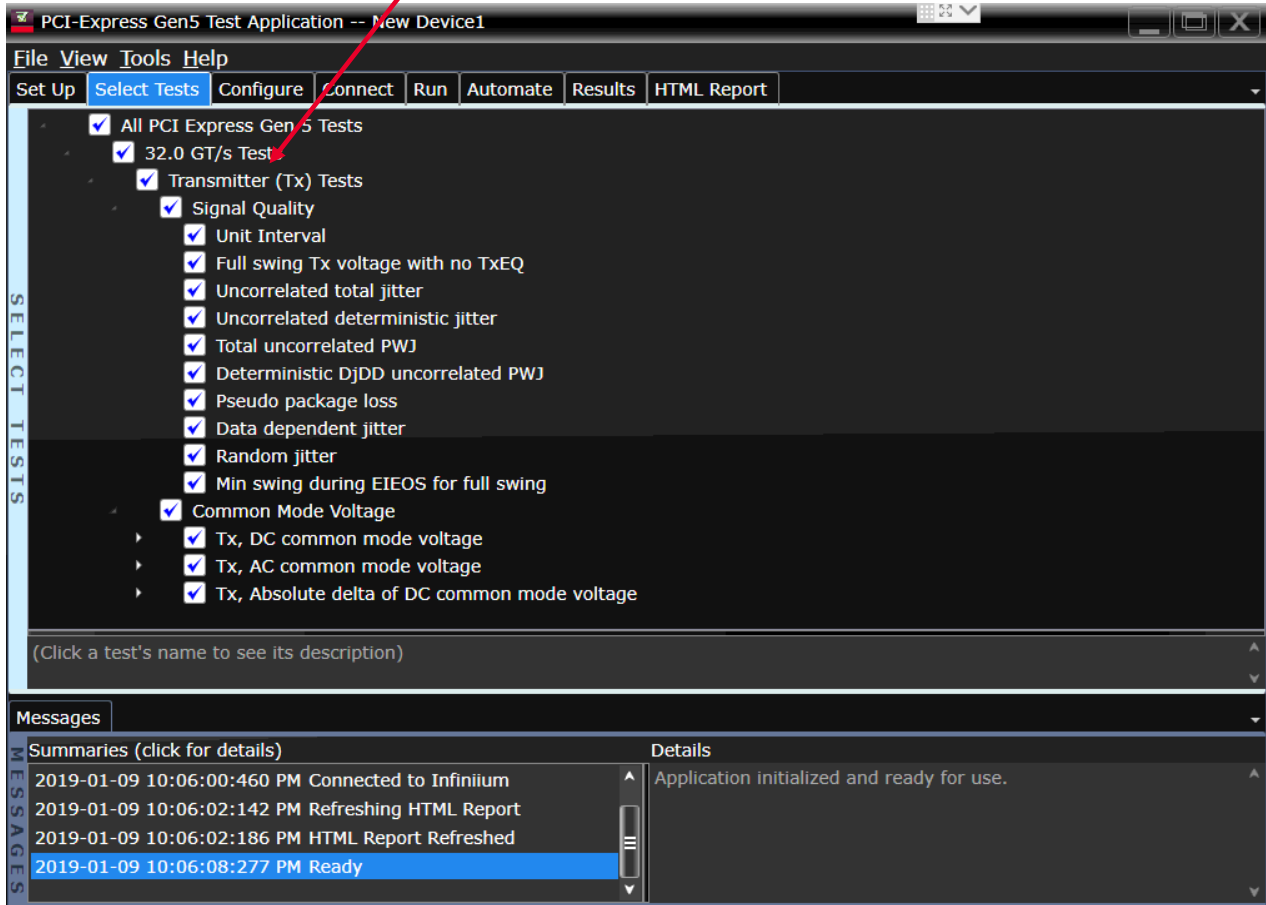

Figure 1. The Keysight automated test engine guides you quickly through selecting tests, configuring tests, setting up the connection, running the tests and viewing the results. Individual tests or groups of tests are easily selected with a mouse click.

PCI Express 5.0

The D9050PCIC compliance application includes support for testing PCI Express 5.0 integrated circuits. This specification elevates the data rate for PCIe 5.0 devices to 32 GT/s. This results in a maximum throughput of approximately 4 GB/s per lane and up to ~128GB/s bidirectionally. PCIe 5.0 shares many elements in common with PCIe 4.0 including 128/130 bit encoding. Nevertheless, at 32 GT/s, the signal is significantly attenuated after even a short length of channel. Many designers may choose to go with lower loss materials when designing with PCIe 5.0 technology which increases the importance of making sure your design has the best signal integrity possible. With Keysight oscilloscopes, you can rest assured that you are using instruments with the lowest noise floor in the industry which helps you to perform your compliance tests with the greatest margin possible.

Specify the InfiniiSim de-embed transfer function to compensate for breakout channel losses.

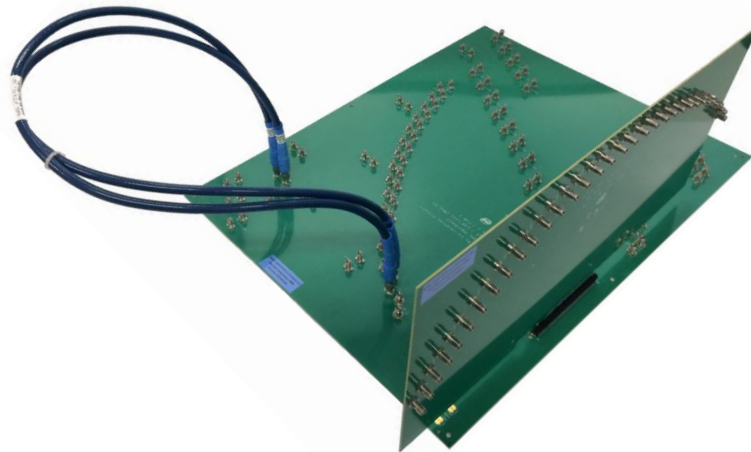
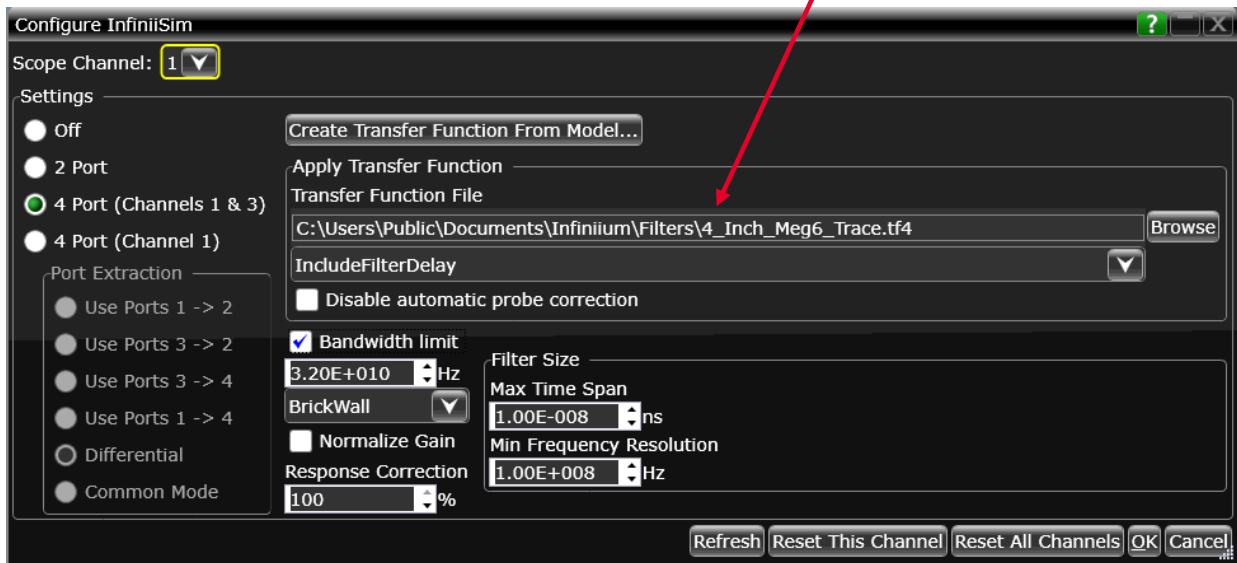

Figure 2. The D9050PCIC PCI Express 5.0 electrical performance validation and compliance software provides you with integrated access to Keysight's Infiniisim waveform transformation toolset (separate license required) for de-embedding of ASIC test channels.

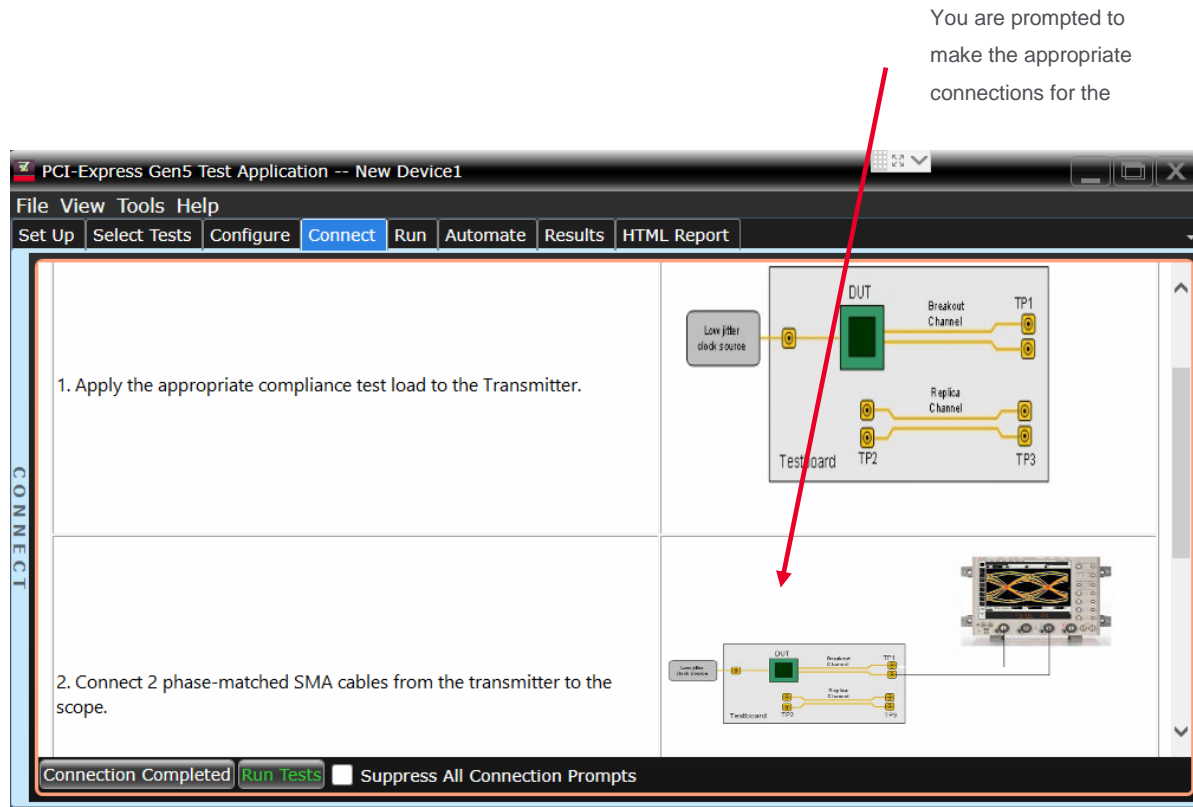

Figure 3. The D9050PCIC PCI Express 5.0 compliance application software includes connection diagrams to assist you with connecting your DUT to the oscilloscope.

Reports with Margin Analysis

In addition to providing you with measurement results, the PCI Express electrical test software provides a report format that shows you not only where your product passes or fails, but also reports how close you are to the limits specified for a particular test assertion. You can select the margin test report parameter, which means you can specify the level at which warnings are issued to alert you to electrical tests where your product is operating close to the official test limits defined by the PCI Express 5.0 specification.

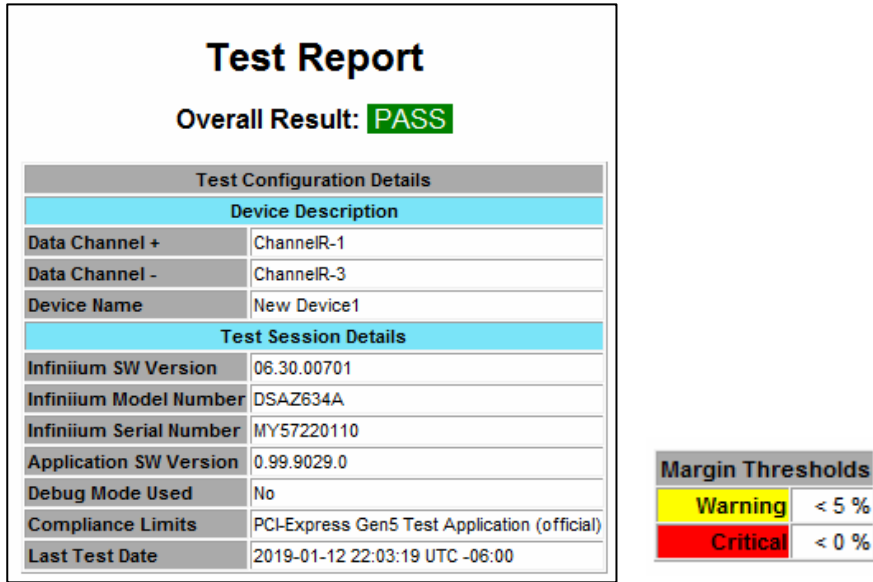

Figure 4. The D9050PCIC PCI Express 5.0 electrical test software results report documents your test results, indicates the pass/fail status, the measured values, and shows you how much margin you have.

Measurement Connection Requirements

The D9050PCIC PCI Express 5.0 electrical performance validation and compliance software requires the E2688A high-speed serial data analysis software, the N5465A InfiniiSim Waveform Transformation Toolset, at least two test cables of appropriate bandwidth. Some of the measurements performed by the D9050PCIC software require that you build or acquire a custom test board, assembly, or other test fixture for your DUT.

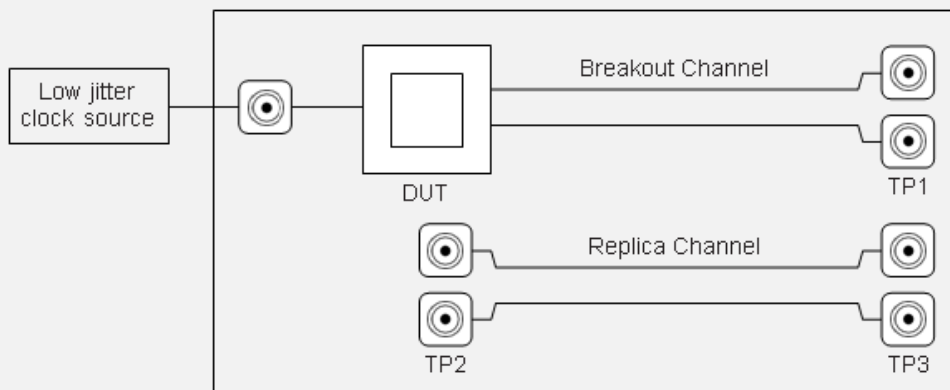

Figure 4. In order to test the transmitter of your PCIe 5.0 silicon, you will need to build or acquire a break-out board that allows you to connect high bandwidth test cables between your ASIC or DUT and your test instrumentation.

Bandwidth Requirements for PCIe 5.0 Tx Testing

PCI Express 5.0 technology operates at speeds up to 32GT/s. The table below provides guidelines to the minimum bandwidth requirements for testing each speed of a PCI Express 5.0 device. While the maximum speed of any PCIe 5.0 is 32GT/s, it is not required that a PCIe 5.0 support that speed; rather, a PCIe 5.0 device need only support any supported PCIe gear maximum but must support every intermediate speed up to that maximum including 2.5GT/s.

In addition to transmitter measurements, phase jitter measurements of the PCIe 100 MHz reference clock also call for a minimum sample rate be used to measure the clock as is also shown below. Use this information to help you select the proper oscilloscope for your specific requirements. Also, remember that receiver testing requires adequate bandwidth to ensure the most accurate calibration of your bit error ratio tester (BERT). Automated receiver calibration using the N5990A Automated Compliance and Device Characterization tool and the Keysight M8040A J-BERT high performance BERT includes integration and control of Keysight high performance oscilloscopes for fast BERT calibration for receiver stressed jitter and stressed voltage testing.

PCI Express Bandwidth requirements by data rate for transmitter measurements and receiver calibration.

| Data Rate | TX Bandwidth Required | Minimum Sample Rate | Minimum Bandwidth required for RX Calibration |
|-----------|-----------------------|---------------------|---|
| 2.5 GT/s | 6 GHz | 20 GSa/s | 12 GHz |
| 5 GT/s | 12 GHz | 40 GSa/s | 12 GHz |
| 8 GT/s | 12 GHz | 40 GSa/s | 25 GHz |
| 16 GT/s | 25 GHz | 80 GSa/s | 25 GHz |
| 32 GT/s | 50 GHz | 160 GSa/s | 50 GHz |

Recommended Test Accessories

In Test accessories for PCIe 5.0 TX testing are largely dependent upon your test requirements, your test fixture design, and a host of other factors. Here are some Keysight products which may be useful.

Cables:

| 40 GHz Electrical (2.92 mm) (K connector) [mates with 3.5 mm] | |
|---|--|
| Part Number | Description |
| N2812B | 50-ohm cable, 2.92 mm (m-m) 1 meter |
| N2823A | 50-ohm cable, 2.92 mm (m-m) matched pair 1 meter |
| N5448B | 50-ohm cable, 2.92 mm (m-m) matched pair 25 cm |

| 50 GHz Electrical (2.4 mm) | |
|----------------------------|--|
| Part Number | Description |
| N4910A | 50-ohm cable, 2.4 mm (m-m), matched pair |

| 67 GHz Electrical (1.85 mm) (V connector) [mates with 2.4 mm] | |
|---|--|
| Part Number | Description |
| N8045A-801 | 50-ohm cable, 1.85 mm (M-m) +/-1 ps 0.16 m |
| N2814A | 50-ohm cable, 1.85 mm(m-m) 1 meter |

Ordering Information

Required hardware and software

D9050PCIC is compatible with Z-Series and UXR Series oscilloscopes with software version 6.30 or greater.

Flexible Software Licensing and KeysightCare Software Support Subscriptions

Keysight offers a variety of flexible licensing options to fit your needs and budget. Choose your license term, license type, and KeysightCare software support subscription.

License Terms

Perpetual – Perpetual licenses can be used indefinitely.

Time-based – Time-based licenses can be used through the term of the license only (6, 12, 24, or 36 months).

License Types

Node-locked – License can be used on one specified instrument/computer.

Transportable – License can be used on one instrument/computer at a time but may be transferred to another using Keysight Software Manager (internet connection required).

USB Portable – License can be used on one instrument/computer at a time but may be transferred to another using a certified USB dongle (available for additional purchase with Keysight part number E8900-D10).

Floating (single site) – Networked instruments/computers can access a license from a server one at a time. Multiple licenses can be purchased for concurrent usage.

KeysightCare Software Support Subscriptions

Perpetual licenses are sold with a 12 (default), 24, 36, or 60-month software support subscription. Support subscriptions can be renewed for a fee after that.

Time-based licenses include a software support subscription through the term of the license.

Selecting your license

Step 1. Choose your software product (eg. D9050PCIC).

Step 2. Choose your license term: perpetual or time-based.

Step 3. Choose your license type: node-locked, transportable, USB portable, or floating.

Step 4. Depending on the license term, choose your support subscription duration.

If you are interested in obtaining a quote for this product, please contact your Keysight representative for pricing and availability.

Learn more at: www.keysight.com

For more information on Keysight Technologies' products, applications or services, please contact your local Keysight office. The complete list is available at: www.keysight.com/find/contactus

