

# Keysight 2-Port and 4-Port PNA Network Analyzer

N5224A 10 MHz to 43.5 GHz

N5225A 10 MHz to 50 GHz

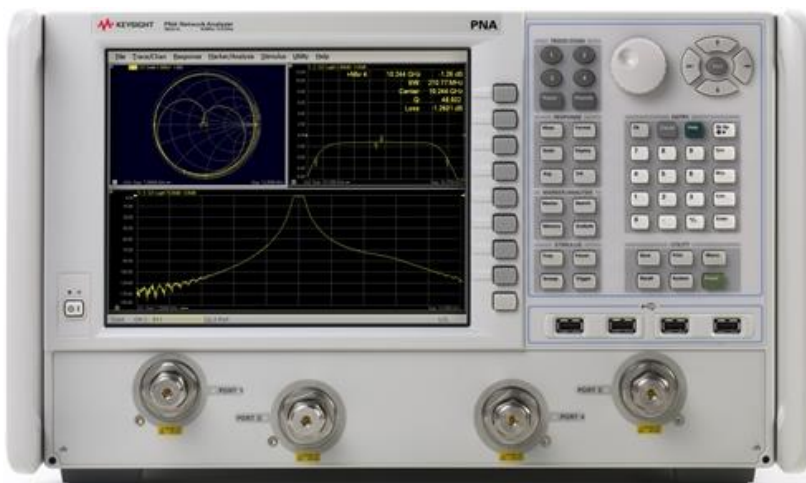

Data Sheet and  
Technical  
Specifications for  
Option 210 and 410

## Documentation Warranty

THE MATERIAL CONTAINED IN THIS DOCUMENT IS PROVIDED "AS IS," AND IS SUBJECT TO BEING CHANGED, WITHOUT NOTICE, IN FUTURE EDITIONS. FURTHER, TO THE MAXIMUM EXTENT PERMITTED BY APPLICABLE LAW, KEYSIGHT DISCLAIMS ALL WARRANTIES, EITHER EXPRESS OR IMPLIED WITH REGARD TO THIS MANUAL AND ANY INFORMATION CONTAINED HEREIN, INCLUDING BUT NOT LIMITED TO THE IMPLIED WARRANTIES OF MERCHANTABILITY AND FITNESS FOR A PARTICULAR PURPOSE. KEYSIGHT SHALL NOT BE LIABLE FOR ERRORS OR FOR INCIDENTAL OR CONSEQUENTIAL DAMAGES IN CONNECTION WITH THE FURNISHING, USE, OR PERFORMANCE OF THIS DOCUMENT OR ANY INFORMATION CONTAINED HEREIN. SHOULD KEYSIGHT AND THE USER HAVE A SEPARATE WRITTEN AGREEMENT WITH WARRANTY TERMS COVERING THE MATERIAL IN THIS DOCUMENT THAT CONFLICT WITH THESE TERMS, THE WARRANTY TERMS IN THE SEPARATE AGREEMENT WILL CONTROL.

## U.S. Government Rights

U.S. Government Rights. The Software is "commercial computer software," as defined by Federal Acquisition Regulation ("FAR") 2.101. Pursuant to FAR 12.212 and 27.405-3 and Department of Defense FAR Supplement ("DFARS") 227.7202, the U.S. government acquires commercial computer software under the same terms by which the software is customarily provided to the public. Accordingly, Keysight provides the Software to U.S. government customers under its standard commercial license, which is embodied in its End User License Agreement (EULA), a copy of which can be found at <http://www.keysight.com/find/sweula>. The license set forth in the EULA represents the exclusive authority by which the U.S. government may use, modify, distribute, or disclose the Software. The EULA and the license set forth therein, does not require or permit, among other things, that Keysight: (1) Furnish technical information related to commercial computer software or commercial computer software documentation that is not customarily provided to the public; or (2) Relinquish to, or otherwise provide, the government rights in excess of these rights customarily provided to the public to use, modify, reproduce, release, perform, display, or disclose commercial computer software or commercial computer software documentation. No additional government requirements beyond those set forth in the EULA shall apply, except to the extent that those terms, rights, or licenses are explicitly required from all providers of commercial computer software pursuant to the FAR and the DFARS and are set forth specifically in writing elsewhere in the EULA. Keysight shall be under no obligation to update, revise or otherwise modify the Software. With respect to any technical data as defined by FAR 2.101, pursuant to FAR 12.211 and 27.404.2 and DFARS 227.7102, the U.S. government acquires no greater than Limited Rights as defined in FAR 27.401 or DFAR 227.7103-5 (c), as applicable in any technical data.

<b>Corrected System Performance .....</b>	<b>6</b>
System Dynamic Range and Receiver Dynamic Range.....	6
Table 1a. System Dynamic Range and Receiver Dynamic Range, N5224A, Option 210, 410 .....	7
Table 1b. System Dynamic Range and Receiver Dynamic Range, N5225A, Option 210, 410 .....	8
N5224A and N5225A Corrected System Performance, Option 210, 410 .....	9
Table 2a. N5224A and N5225A with 85056A Calibration Kit .....	9
Table 2b. N5224A and N5225A with N4693A 2-Port Electronic Calibration Module.....	12
<b>Uncorrected System Performance .....</b>	<b>14</b>
Table 3a. Error Terms (dB), All Ports, Option 210, 410 - Specifications .....	14
Table 3b. Error Terms (dB), All Ports, Option 210, 410 - Typical .....	15
<b>Test Port Output.....</b>	<b>16</b>
Table 4. Frequency Information, Option 210, 410 .....	16
Table 5. Maximum Leveled Power (dBm), All Ports, Option 210, 410.....	16
Table 6. Power Level Accuracy (dB), Option 210, 410.....	17
Table 7a. Power Level Linearity (dB), Option 210, 410 - Specification .....	17
Table 7b. Power Level Linearity (dB), Option 210, 410 - Specification.....	17
Table 8. N5224 and N5225A Power Sweep Range (dB), All Ports, Option 210, 410.....	18
Table 9. Nominal (Preset) Power (dBm).....	18
Table 10. Power Resolution and Maximum/Minimum Settable Power, All Models, Option 210, 410 .....	18
Table 11. 2 <sup>nd</sup> and 3 <sup>rd</sup> Harmonics at Max Specified Power (dBc).....	19
Table 12. Non-Harmonic Spurs at Nominal Power (dBc).....	19
Table 13. Phase Noise (dBc/Hz), Option 210, 410 - Typical .....	20
<b>Test Port Input .....</b>	<b>21</b>
Table 14. Test Port Noise Floor (dBm) @ 10 Hz IFBW, Option 210, 410 .....	21
Table 15a. 0.1 dB Receiver Compression at Test Port (dBm), Option 210, 410 - Typical .....	21
Table 15b. Receiver Compression at Test Power - Specification.....	22
Table 16. Trace Noise Magnitude (dB rms).....	22
Table 17. Trace Noise Phase (deg rms).....	23
Table 18. Reference Level Magnitude, Option 210, 410 - Specification.....	23
Table 19a. Stability vs. Temperature, Option 210, 410 - Typical .....	23
Table 19b. Stability vs. Time, Option 210, 410 - Specification .....	24
Table 20. Damage Input Level, All ports.....	24

Dynamic Accuracy .....	25
Table 21. N5224A and N5225A Dynamic Accuracy .....	25
Table 22. Group Delay - Typical.....	29
<b>General Information .....</b>	<b>30</b>
Table 23. Miscellaneous Information .....	30
Table 24. Front Panel Information, Option 210, 410 .....	30
Table 25. Rear Panel Information, Option 210, 410 .....	31
Table 26. Analyzer Dimensions and Weight .....	35
Regulatory and Environmental Information .....	35
<b>Measurement Throughput Summary .....</b>	<b>36</b>
Table 27a. Typical Cycle Time (ms) for Measurement Completion, All Models and Options .....	36
Table 27b. N5224A/25A Typical Cycle Time (ms) for Full-Span Measurement Completion.....	37
Table 27c. N5224A/25A Typical Cycle Time (ms) for Full-Span Measurement Completion.....	37
Table 28. Cycle Time vs. IF Bandwidth - Typical .....	38
Table 29. Cycle Time vs. Number of Points - Typical .....	39
Table 30. Data Transfer Time (ms) - Typical.....	40
<b>Test Set Block Diagrams.....</b>	<b>41</b>
N5224A and N5225A Option 210 (2-port metrology configuration).....	41
N5224A and N5225A Option 410 (4-port metrology configuration).....	41
Receiver Block Diagram .....	42

This is a complete list of the technical specifications for the N5224A and N5225A PNA network analyzers with the following options:

#### 2-Port Model

**Option 210** – 2-port, single source, with metrology configuration

#### 4-Port Model

**Option 410** – 4-port, dual source, with metrology configuration

See block diagrams on page 38.

#### Notes

This document provides technical specifications for the 85056A and N4693A calibration kits.

Please download our free Uncertainty Calculator from [http://www.keysight.com/find/na\\_calculator](http://www.keysight.com/find/na_calculator) to generate the curves for your calibration kit and PNA setup.

For all tables in this data sheet, the specified performance at the exact frequency of a break is the degraded value of the two specifications at that frequency.

#### Definitions

All specifications and characteristics apply over a 25 °C ±5 °C range (unless otherwise stated) and 90 minutes after the instrument has been turned on.

**Specification (spec.):** Warranted performance. Specifications include guardbands to account for the expected statistical performance distribution, measurement uncertainties, and changes in performance due to environmental conditions.

**Characteristic (char.):** A performance parameter that the product is expected to meet before it leaves the factory, but that is not verified in the field and is not covered by the product warranty. A characteristic includes the same guardbands as a specification.

**Typical (typ.):** Expected performance of an average unit which does not include guardbands. It is not covered by the product warranty.

**Nominal (nom.):** A general, descriptive term that does not imply a level of performance. It is not covered by the product warranty.

**Calibration:** The process of measuring known standards to characterize a network analyzer's systematic (repeatable) errors.

**Corrected (residual):** Indicates performance after error correction (calibration). It is determined by the quality of calibration standards and how well "known" they are, plus system repeatability, stability, and noise.

**Uncorrected (raw):** Indicates instrument performance without error correction. The uncorrected performance affects the stability of a calibration.

**Standard:** When referring to the analyzer, this includes no options unless noted otherwise.

## Corrected System Performance

The specifications in this section apply for measurements made with the N5224A and N5225A PNA network analyzers with the following conditions:

- 10 Hz IF bandwidth
- No averaging applied to data
- Isolation calibration with an averaging factor of 8

### System Dynamic Range and Receiver Dynamic Range

- **System Dynamic Range** is defined as the specified source maximum output power (spec) minus the noise floor (spec).
- **Receiver Dynamic Range** is defined as the test port compression at 0.1 dB (typical) minus the noise floor (typical).

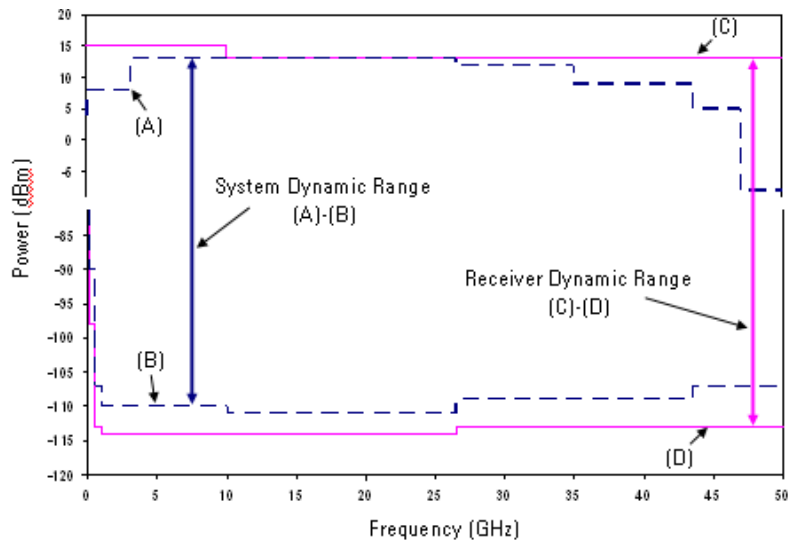

#### NOTE

The effective dynamic range must take measurement uncertainties and interfering signals into account. This set-up should only be used when the receiver input will never exceed its maximum receiver input. When the analyzer is in segment sweep mode, it can have predefined frequency segments which will output a higher power level when the extended dynamic range is required (i.e. devices with high insertion loss), and reduced power when the maximum receiver input level will occur (i.e. devices with low insertion loss). The extended range is only available in one-path transmission measurements.

It may typically be degraded at particular frequencies below 500 MHz due to spurious receiver residuals.

Table 1a. System Dynamic Range and Receiver Dynamic Range, N5224A, Option 210, 410

Description	Specification			Typical			
	System Dynamic Range (dB) (A)-(B)	Max Leveled Output Power (dBm) (A)	Test Port Noise Floor (dBm) (B)	System Dynamic Range (dB)	Receiver Dynamic Range (dB) (C)-(D)	0.1 dB Compression at Test Port (dBm) (C)	Test Port Noise Floor (dBm) (D)
10 MHz to 50 MHz	76	6	-70	87	90	15	-75
50 MHz to 100 MHz	92	7	-85	103	106	15	-91
100 MHz to 250 MHz	102	7	-95	112	112	12	-100
250 MHz to 500 MHz	109	7	-102	119	119	12	-107
500 MHz to 1 GHz	113	7	-106	124	124	12	-112
1 GHz to 2 GHz	121	7	-114	131	130	12	-118
2 GHz to 3.2 GHz	121	7	-114	129	130	12	-118
3.2 GHz to 10 GHz	121	7	-114	132	130	12	-118
10 GHz to 13.5 GHz	121	7	-114	131	132	12	-120
13.5 GHz to 16 GHz	121	7	-114	132	132	12	-120
16 GHz to 26.5 GHz	121	7	-114	130	132	12	-120
26.5 GHz to 30 GHz	117	7	-110	126	128	12	-116
30 GHz to 35 GHz	117	7	-110	124	128	12	-116
35 GHz to 40 GHz	112	4	-108	122	128	12	-116
40 GHz to 43.5 GHz	112	4	-108	120	124	10	-114

Table 1b. System Dynamic Range and Receiver Dynamic Range, N5225A, Option 210, 410

Description	Specification			Typical			
	System Dynamic Range (dB) (A)-(B)	Max Leveled Output Power (dBm) (A)	Test Port Noise Floor (dBm) (B)	System Dynamic Range (dB)	Receiver Dynamic Range (dB) (C)-(D)	0.1 dB Compression at Test Port (dBm) (C)	Test Port Noise Floor (dBm) (D)
10 MHz to 50 MHz	76	6	-70	87	90	15	-75
50 MHz to 100 MHz	92	7	-85	103	106	15	-91
100 MHz to 250 MHz	102	7	-95	112	112	12	-100
250 MHz to 500 MHz	109	7	-102	119	119	12	-107
500 MHz to 1 GHz	113	7	-106	124	124	12	-112
1 GHz to 2 GHz	121	7	-114	131	130	12	-118
2 GHz to 3.2 GHz	121	7	-114	129	130	12	-118
3.2 GHz to 10 GHz	121	7	-114	132	130	12	-118
10 GHz to 13.5 GHz	121	7	-114	131	132	12	-120
13.5 GHz to 16 GHz	121	7	-114	132	132	12	-120
16 GHz to 26.5 GHz	121	7	-114	130	132	12	-120
26.5 GHz to 30 GHz	117	7	-110	126	128	12	-116
30 GHz to 35 GHz	117	7	-110	124	128	12	-116
35 GHz to 40 GHz	112	4	-108	122	128	12	-116
40 GHz to 43.5 GHz	112	4	-108	120	124	10	-114
43.5 GHz to 47 GHz	109	0	-109	117	126	10	-116
47 GHz to 50 GHz	101	-8	-109	116	126	10	-116



## N5224A and N5225A Corrected System Performance, Option 210, 410

For any  $S_{ii}$  reflection measurement:

- $S_{jj} = 0$ .

For any  $S_{ij}$  transmission measurement:

- $S_{ji} = S_{ij}$  when  $S_{ij} \leq 1$
- $S_{ji} = 1/S_{ij}$  when  $S_{ij} > 1$
- $S_{kk} = 0$  for all  $k$

Applies to the N5224A/5A Option 210 or 410 analyzers, 85133F flexible test port cable set, and a full 2-port calibration. Also applies to the following condition:

Environmental temperature  $23^\circ \pm 3^\circ \text{C}$ , with  $< 1^\circ \text{C}$  deviation from calibration temperature

Table 2a. N5224A and N5225A with 85056A Calibration Kit

Description	Specification (dB)						
	10 MHz to 50 MHz	50 MHz to 2 GHz	2 GHz to 10 GHz	10 GHz to 20 GHz	20 GHz to 30 GHz	30 GHz to 40 GHz	40 GHz to 50 GHz
Directivity	42	42	42	42	38	38	36
Source Match	41	41	38	38	33	33	31
Load Match	42	42	42	42	38	38	35
Reflection Tracking							
Mag	0.001	0.001	0.008	0.008	0.020	0.020	0.027
Phase (degree)	0.009	0.009	0.054	0.054	0.133	0.133	0.180
Transmission Tracking							
Mag	0.019	0.012	0.022	0.035	0.078	0.078	0.128
Phase (degree)	0.127	0.080	0.147	0.232	0.513	0.513	0.845

# Transmission Uncertainty, Option 210, 410

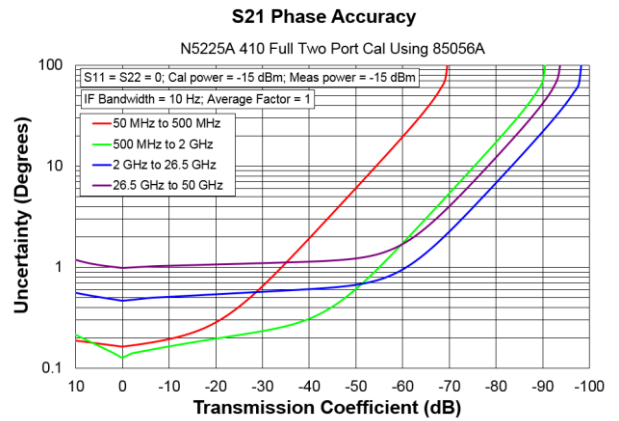
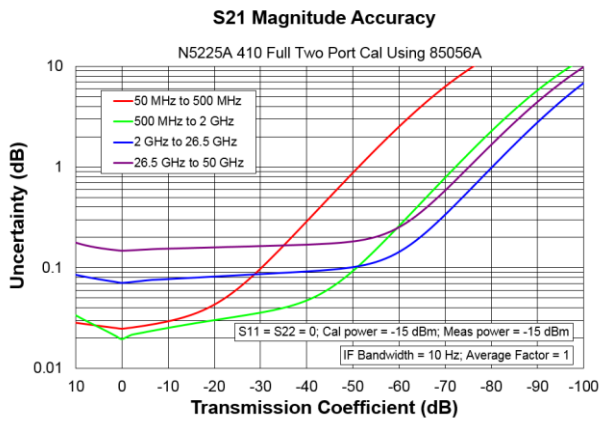
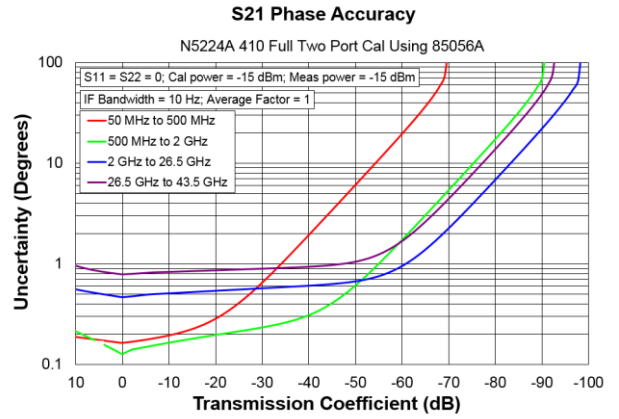
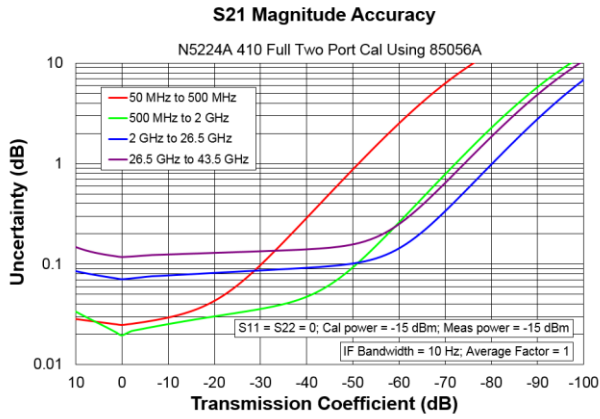

# Reflection Uncertainty, Option 210, 410

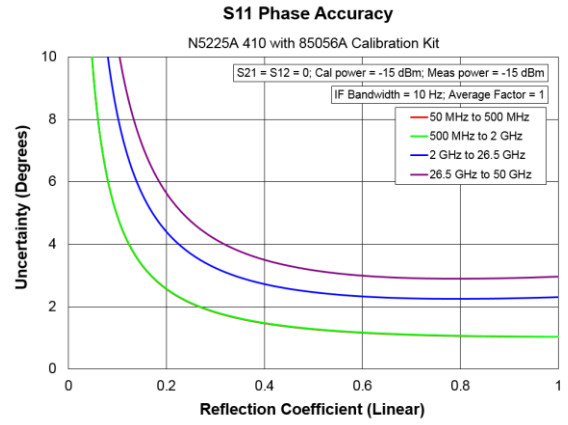
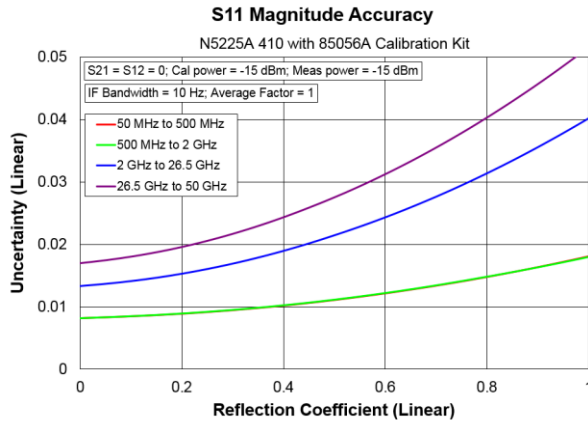
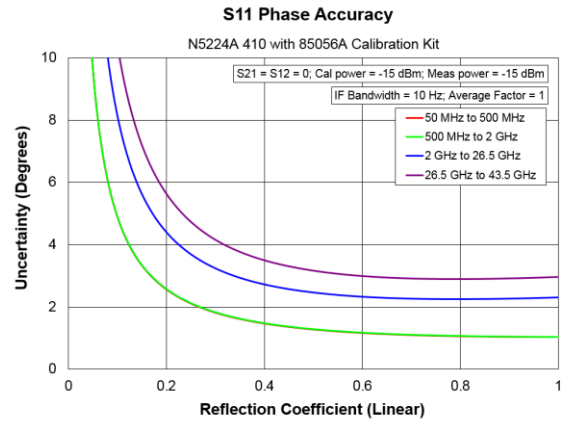
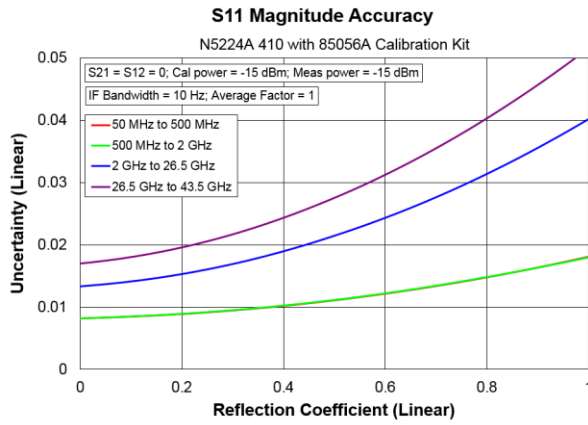
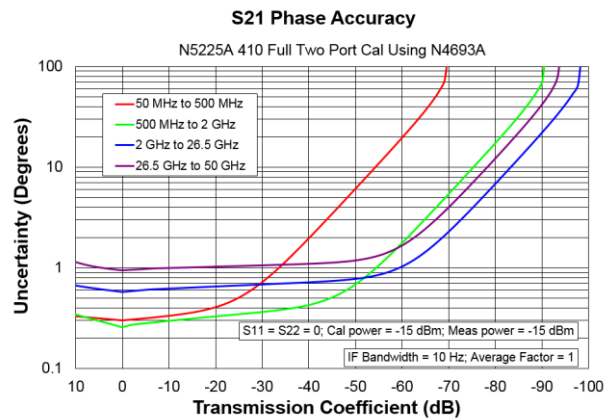
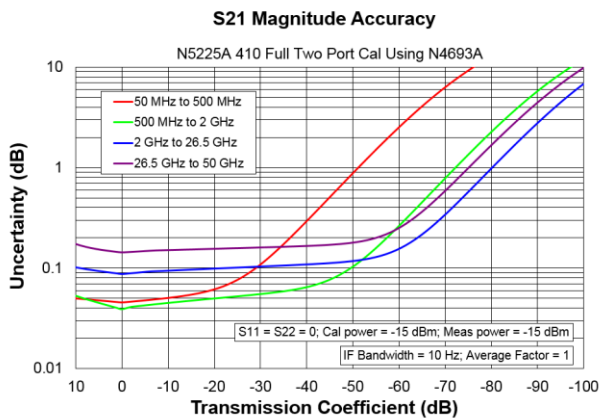
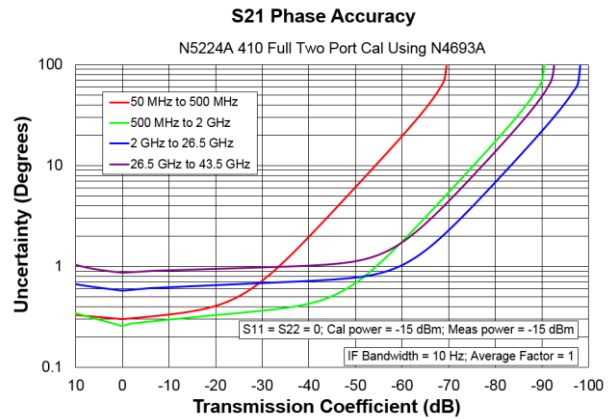
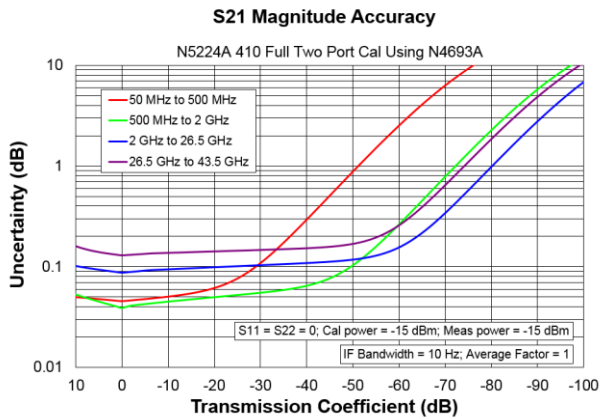

Table 2b. N5224A and N5225A with N4693A 2-Port Electronic Calibration Module

Description	Specification (dB)						
	10 MHz to 50 MHz	50 MHz to 2 GHz	2 GHz to 10 GHz	10 GHz to 20 GHz	20 GHz to 30 GHz	30 GHz to 40 GHz	40 GHz to 50 GHz
Directivity	32	55	49	49	38	38	36
Source Match	25	46	42	42	33	33	31
Load Match	25	45	41	41	38	38	35
Reflection Tracking							
Mag	0.050	0.030	0.040	0.040	0.020	0.020	0.027
Phase (degree)	0.330	0.198	0.264	0.264	0.133	0.133	0.180
Transmission Tracking							
Mag	0.081	0.031	0.043	0.045	0.078	0.078	0.128
Phase (degree)	0.532	0.207	0.287	0.300	0.513	0.513	0.845

Transmission Uncertainty, Option 210, 410



# Reflection Uncertainty, Option 210, 410

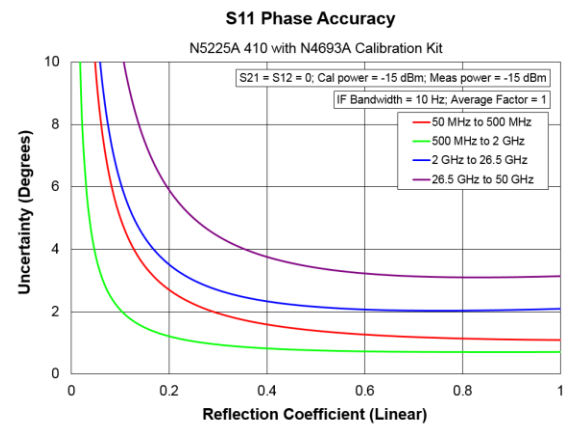
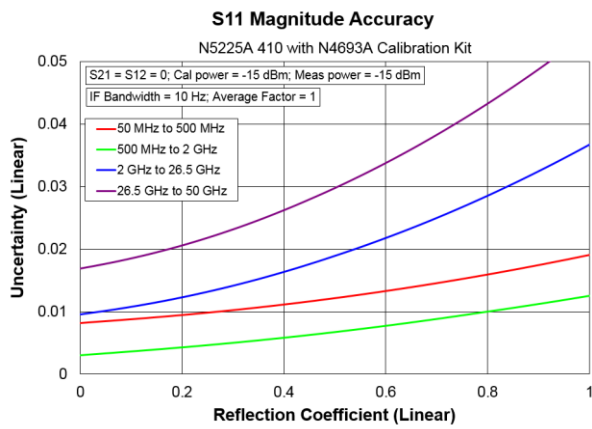
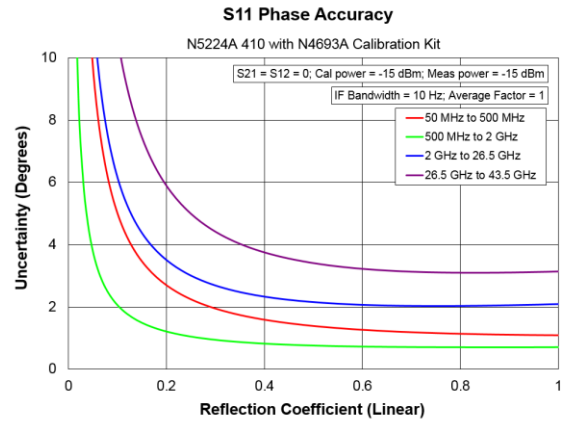
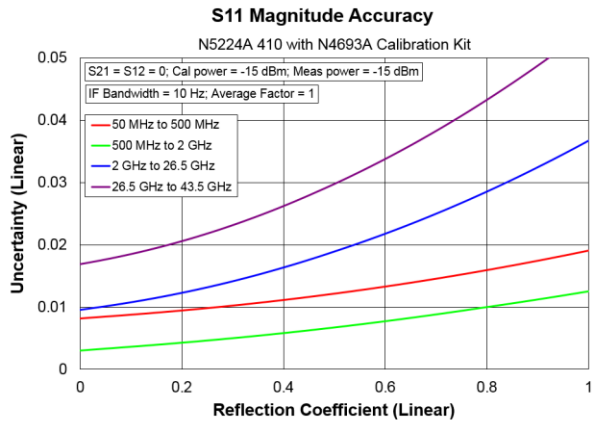

## Uncorrected System Performance

Specifications apply to following conditions:

- Cable loss not included in Transmission Tracking.
- Crosstalk measurement conditions: normalized to a thru, measured with shorts on all ports, 10 Hz IF bandwidth, averaging factor of 8, alternate mode, source power set to the specified maximum power.

Table 3a. Error Terms (dB), All Ports, Option 210, 410 - Specifications

Description	Directivity	Source Match	Load Match	Transmission Tracking	Reflection Tracking	Crosstalk
10 MHz to 50 MHz	18	18	17	--	--	--
50 MHz to 200 MHz	22	22	22	--	--	--
200 MHz to 500 MHz	24	26	26	--	--	--
500 MHz to 3.2 GHz	25	22	21	--	--	--
3.2 GHz to 10 GHz	22	17	19	--	--	--
10 GHz to 13.5 GHz	18	14	17			
13.5 GHz to 16 GHz	18	14	15			
16 GHz to 20 GHz	18	13	15	--	--	--
20 GHz to 24 GHz	16	14	15			
24 GHz to 26.5 GHz	16	14	15	--	--	--
26.5 GHz to 43.5 GHz	16	10	13	--	--	--
43.5 GHz to 46 GHz	15	10	13			
46 GHz to 50 GHz	15	9	10	--	--	--

Table 3b. Error Terms (dB), All Ports, Option 210, 410 - Typical

Description	Directivity	Source Match	Load Match	Transmission Tracking	Reflection Tracking	Crosstalk
10 MHz to 50 MHz	21	26	24	+/- 1.0	+/- 0.7	-82
50 MHz to 200 MHz	28	30	28	+/- 1.0	+/- 0.7	-85
200 MHz to 500 MHz	33	30	30	+/- 1.0	+/- 0.7	-110
500 MHz to 3.2 GHz	30	27	26	+/- 1.0	+/- 0.7	-120
3.2 GHz to 10 GHz	25	22	24	+/- 1.0	+/- 0.7	-120
10 GHz to 13.5 GHz	23	22	23	+/- 1.0	+/- 0.7	-120
13.5 GHz to 16 GHz	20	21	20	+/- 1.0	+/- 0.7	-120
16 GHz to 20 GHz	19	19	21	+/- 1.0	+/- 0.7	-120
20 GHz to 24 GHz	20	20	21	+/- 1.0	+/- 0.7	-120
24 GHz to 26.5 GHz	21	19	20	+/- 1.0	+/- 0.7	-120
26.5 GHz to 35 GHz	19	16	18	+/- 1.0	+/- 0.7	-120
35 GHz to 43.5 GHz	19	16	18	+/- 1.0	+/- 0.7	-115
43.5 GHz to 46 GHz	19	18	18	+/- 1.0	+/- 0.7	-105
46 GHz to 50 GHz	19	14	15	+/- 1.0	+/- 0.7	-100

## Test Port Output

See Block diagrams for all models and options.

Table 4. Frequency Information, Option 210, 410

Description	Specification	Typical
N5224A Frequency Range	10 MHz to 43.5 GHz	--
N5225A Frequency Range	10 MHz to 50 GHz	--
Frequency Resolution	1 Hz	--
Frequency Accuracy	+/- 1 ppm	--
Frequency Stability	--	+/-0.05 ppm, -10° to 70° C <sup>1</sup> +/-0.1 ppm/yr maximum <sup>2</sup>

<sup>1</sup> Assumes no variation in time.

<sup>2</sup> Assumes no variation in temperature.

Table 5. Maximum Leveled Power (dBm), All Ports, Option 210, 410

Description	Specification	Typical
10 MHz to 50 MHz	6	12
50 MHz to 1 GHz	7	12
1 GHz to 2 GHz	7	13
2 GHz to 3.2 GHz	7	11
3.2 GHz to 10 GHz	7	14
10 GHz to 13.5 GHz	7	11
13.5 GHz to 16 GHz	7	12
16 GHz to 20 GHz	7	11
20 GHz to 24 GHz	7	10
24 GHz to 26.5 GHz	7	10
26.5 GHz to 30 GHz	7	10
30 GHz to 35 GHz	7	8
35 GHz to 43.5 GHz	4	6
43.5 GHz to 47 GHz	0	1
47 GHz to 50 GHz	-8	0



Table 6. Power Level Accuracy (dB), Option 210, 410

Description	Specification	Typical
10 MHz to 50 MHz	+/- 1.5	+/- 0.5
50 MHz to 1 GHz	+/- 1.0	+/- 0.4
1 GHz to 3.2 GHz	+/- 1.2	+/- 0.1
3.2 GHz to 13.5 GHz	+/- 1.5	+/- 0.3
13.5 GHz to 20 GHz	+/- 1.5	+/- 0.2
20 GHz to 26.5 GHz	+/- 1.8	+/- 0.2
26.5 GHz to 43.5 GHz	+/- 2.2	+/- 0.3
43.5 GHz to 50 GHz	+/- 3.2	+/- 0.5

Table 7a. Power Level Linearity (dB), Option 210, 410 – Specification

Description	Port 1 or 3 <sup>1</sup> -25dBm ≤ P < -20dBm	Port 1 or 3 <sup>1</sup> -20dBm ≤ P < -15dBm	Port 1 or 3 <sup>1</sup> P ≥ -15dBm
10 MHz to 50 MHz	+/-2.5	+/-1.5	+/-1.5
50 MHz to 500 MHz	+/-2.0	+/-1.5	+/-1.5
500 MHz to 50 GHz	+/-1.5	+/-1.5	+/-1.5

<sup>1</sup> Either port can be used as the source port.

Table 7b. Power Level Linearity (dB), Option 210, 410 – Specification

Description	Port 2 or 4 <sup>1</sup> -25dBm ≤ P < -20dBm	Port 2 or 4 <sup>1</sup> -20dBm ≤ P < -15dBm	Port 2 or 4 <sup>1</sup> P ≥ -15dBm
10 MHz to 50 MHz	+/-2.5	+/-1.5	+/-1.5
50 MHz to 3.2 GHz	+/-2.0	+/-1.5	+/-1.5
3.2 GHz to 50 GHz	+/-1.5	+/-1.5	+/-1.5

<sup>1</sup> Either port can be used as the source port.

Table 8. N5224 and N5225A Power Sweep Range (dB), All Ports, Option 210, 410

Description	Specification	Typical
10 MHz to 50 MHz	31	39
50 MHz to 1 GHz	32	39
1 GHz to 2 GHz	32	40
2 GHz to 3.2 GHz	32	39
3.2 GHz to 10 GHz	32	41
10 GHz to 13.5 GHz	32	39
13.5 GHz to 16 GHz	32	41
16 GHz to 26.5 GHz	32	39
26.5 GHz to 30 GHz	32	40
30 GHz to 35 GHz	32	39
35 GHz to 43.5 GHz	29	36
43.5 GHz to 47 GHz	25	33
47 GHz to 50 GHz	17	29

Table 9. Nominal (Preset) Power (dBm)

Description	N5224A	N5225A
Preset Power	-5	-15

Table 10. Power Resolution and Maximum/Minimum Settable Power, All Models, Option 210, 410

Description	Specification (dB)	Typical (dBm)
Power Resolution	0.01	
Maximum Settable Power	--	30
Minimum Settable Power	--	-30

Table 11. 2<sup>nd</sup> and 3<sup>rd</sup> Harmonics at Max Specified Power (dBc)

Option 210, 410 - Typical

Listed frequency is harmonic frequency; test at max specified power.

Description	N5224A	N5225A
20 MHz to 4 GHz	-15	-15
4 GHz to 6 GHz	-18	-18
6 GHz to 24 GHz	-19	-19
24 GHz to 27 GHz	-21	-21
27 GHz to 40.5 GHz	-29	-29
40.5 GHz to 43.5 GHz	-60	-60
43.5 GHz to 50 GHz	--	-60

Table 12. Non-Harmonic Spurs at Nominal Power (dBc)

Option 210, 410 - Typical

Description	Based on 8kHz offset Frac-N	Based on 100kHz offset Frac-N
10 MHz to 500 MHz	-50	-50
500 MHz to 2 GHz	-60	-42
2 GHz to 4 GHz	-57	-45
4 GHz to 8 GHz	-51	-39
8 GHz to 16 GHz	-45	-33
16 GHz to 32 GHz	-39	-27
32 GHz to 50 GHz	-33	-21

Table 13. Phase Noise (dBc/Hz), Option 210, 410 - Typical

Description	1 kHz Offset	10 kHz Offset	100 kHz Offset	1 MHz Offset
10 MHz to 50 MHz	-100	-95	-95	-120
50 MHz to 1 GHz	-107	-117	-112	-127
1 GHz to 2 GHz	-101	-111	-106	-121
2 GHz to 4 GHz	-95	-105	-100	-115
4 GHz to 8 GHz	-89	-99	-94	-109
8 GHz to 16 GHz	-83	-93	-88	-103
16 GHz to 32 GHz	-77	-87	-82	-97
32 GHz to 50 GHz	-71	-81	-76	-91

## Test Port Input

Table 14. Test Port Noise Floor (dBm) @ 10 Hz IFBW, Option 210, 410

Total average (rms) noise power calculated as the mean value of a linear magnitude trace expressed in dBm. May typically be degraded at particular frequencies below 500 MHz due to spurious receiver residuals.

Description	Specification		Typical	
	N5224A	N5225A	N5224A	N5225A
10 MHz to 50 MHz	-70	-70	-75	-75
50 MHz to 100 MHz	-85	-85	-91	-91
100 MHz to 250 MHz	-95	-95	-100	-100
250 MHz to 500 MHz	-102	-102	-107	-107
500 MHz to 1 GHz	-106	-106	-112	-112
1 GHz to 10 GHz	-114	-114	-118	-118
10 GHz to 26.5 GHz	-114	-114	-120	-120
26.5 GHz to 35 GHz	-110	-110	-116	-116
35 GHz to 40 GHz	-108	-108	-116	-116
40 GHz to 43.5 GHz	-108	-108	-114	-114
43.5 GHz to 50 GHz	--	-109	--	-116

Table 15a. 0.1 dB Receiver Compression at Test Port (dBm), Option 210, 410 - Typical

Description	N5224A	N5225A
10 MHz to 100 MHz	15	15
100 MHz to 40 GHz	12	12
40 GHz to 43.5 GHz	10	10
43.5 GHz to 50 GHz	--	10

Table 15b. Receiver Compression at Test Power - Specification

Description	Test Port Power (dBm)	Receiver Compression	
	Option 210, 410	Magnitude (dB)	Phase (degrees)
10 MHz to 500 MHz <sup>1</sup>	--	--	--
500 MHz to 10 GHz	8	0.11	0.60
10 GHz to 20 GHz	8	0.11	0.65
20 GHz to 26.5 GHz	8	0.12	0.7
26.5 GHz to 30 GHz	8	0.13	0.8
30 GHz to 35 GHz	5	0.13	0.7
35 GHz to 40 GHz	3	0.14	0.7
40 GHz to 43.5 GHz	2	0.14	0.75
43.5 GHz to 47 GHz	2	0.14	1.25
47 GHz to 50 GHz	2	0.14	1.25

<sup>1</sup>Test port receiver compression at specified input levels below 500 MHz due to coupler roll off in this frequency range.

Table 16. Trace Noise Magnitude (dB rms)

Ratioed measurement, nominal power at test port.

Description	Specification	Typical		
	1 kHz IFBW	1 kHz IFBW	100 kHz IFBW	600 kHz IFBW
10 MHz to 50 MHz	0.200	0.071	0.667	1.612
50 MHz to 100 MHz	0.020	0.009	0.088	0.209
100 MHz to 500 MHz	0.020	0.004	0.040	0.098
500 MHz to 1 GHz	0.003	0.001	0.009	0.022
1 GHz to 26.5 GHz	0.003	0.001	0.006	0.015
26.5 GHz to 43.5 GHz	0.003	0.001	0.009	0.021
43.5 GHz to 50 GHz	0.004	0.002	0.007	0.018

Table 17. Trace Noise Phase (deg rms)

Ratioed measurement, nominal power at test port.

Description	Specification	Typical		
	1 kHz IFBW	1 kHz IFBW	100 kHz IFBW	600 kHz IFBW
10 MHz to 50 MHz	1.000	0.485	4.681	11.310
50 MHz to 100 MHz	1.000	0.062	0.614	1.456
100 MHz to 500 MHz	0.500	0.029	0.276	0.680
500 MHz to 1 GHz	0.020	0.006	0.061	0.149
1 GHz to 26.5 GHz	0.020	0.008	0.040	0.100
26.5 GHz to 43.5 GHz	0.030	0.014	0.067	0.159
43.5 GHz to 50 GHz	0.030	0.015	0.061	0.142

Table 18. Reference Level Magnitude, Option 210, 410 - Specification

Description	Magnitude (dB)	Phase (degrees)
Range	+/- 500	+/- 500
Resolution	0.001	0.01

Table 19a. Stability vs. Temperature, Option 210, 410 - Typical

Description	Magnitude (dB/°C)	Phase (°/°C)
10 MHz to 50 MHz	0.020	0.200
50 MHz to 3.2 GHz	0.010	0.100
3.2 GHz to 10 GHz	0.010	0.200
10 GHz to 16 GHz	0.010	0.250
16 GHz to 20 GHz	0.015	0.300
20 GHz to 26.5 GHz	0.015	0.400
26.5 GHz to 35 GHz	0.020	0.600
35 GHz to 43.5 GHz	0.020	0.650
43.5 GHz to 47 GHz	0.025	0.700
47 GHz to 50 GHz	0.027	0.750

**Table 19b. Stability vs. Time, Option 210, 410 – Specification**

The specifications below are observations of the maximum drift performance over +/- 0.5 °C and a period of 24 hours subsequent to a 48 hours warm up period, with ideal load for reflections and ideal thru for transmission measurements.

Description	Magnitude (dB/24 hours)		
	S11, S22, S33, S44	S21, S12, S43, S34	S31, S13, S41, S14, S42, S24, S32, S23
10 MHz to 12 MHz <sup>1</sup>	-52	0.025	0.025
12 MHz to 500 MHz <sup>1</sup>	-60	0.013	0.018
500 MHz to 3.2 GHz	-65	0.010	0.014
3.2 GHz to 10 GHz	-65	0.012	0.017
10 GHz to 13.5 GHz	-65	0.019	0.027
13.5 GHz to 16 GHz	-65	0.019	0.027
16 GHz to 20 GHz	-65	0.022	0.031
20 GHz to 24 GHz	-65	0.028	0.040
24 GHz to 26.5 GHz	-65	0.028	0.040
26.5 GHz to 32 GHz	-60	0.035	0.049
32 GHz to 40 GHz	-60	0.045	0.064
40 GHz to 43.5 GHz	-60	0.055	0.078
43.5 GHz to 47 GHz	-60	0.055	0.078
47 GHz to 50 GHz	-60	0.059	0.083

<sup>1</sup> Performance may be degraded at frequencies below 500 MHz due to spurious receiver residuals.

**Table 20. Damage Input Level, All ports**

Description	Option 210, 410
RF, DC	27 dBm, 40 V



## Dynamic Accuracy

Dynamic accuracy is verified with the following measurements:

Compression over frequency

IF linearity at a single frequency of 1.998765GHz using a reference level of -20 dBm for an input power range of 0 to -60 dBm. For values below -60 dBm, refer to [VNA Receiver Dynamic Accuracy Specifications and Uncertainties](#).

Table 21. N5224A and N5225A Dynamic Accuracy

### N5224A/25A Dynamic Accuracy, 50 MHz - Specification

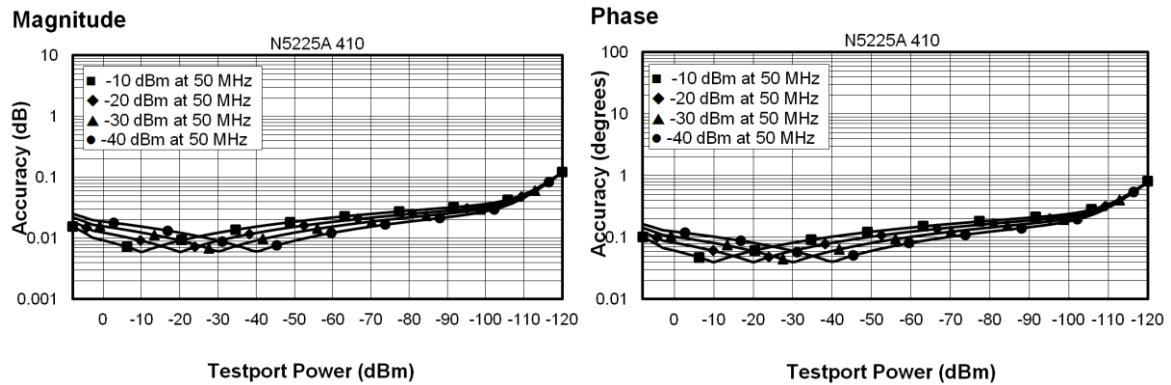

### N5224A/25A Dynamic Accuracy, 500 MHz - Specification

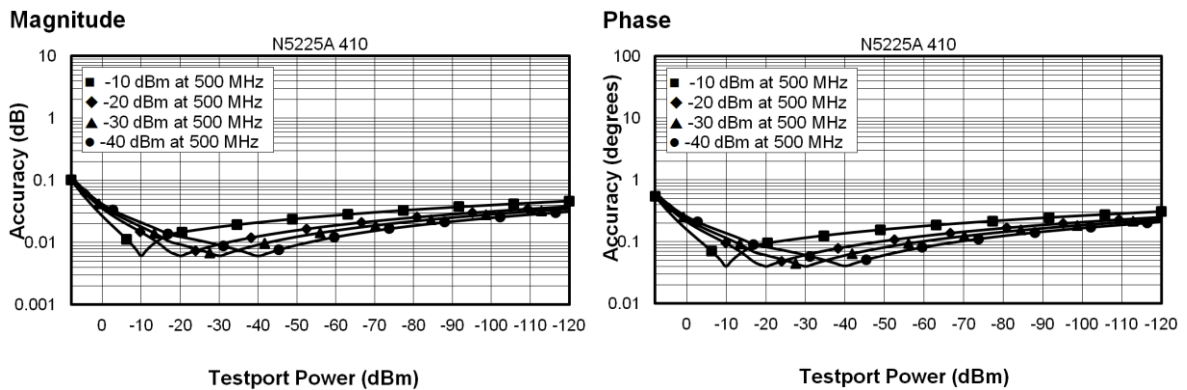

## N5224A/25A Dynamic Accuracy, 1 GHz - Specification

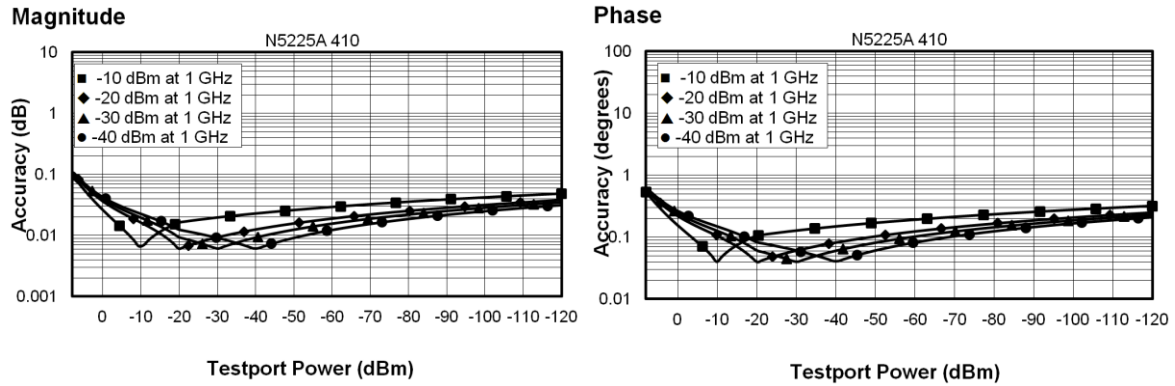

## N5224A/25A Dynamic Accuracy, 2 GHz - Specification

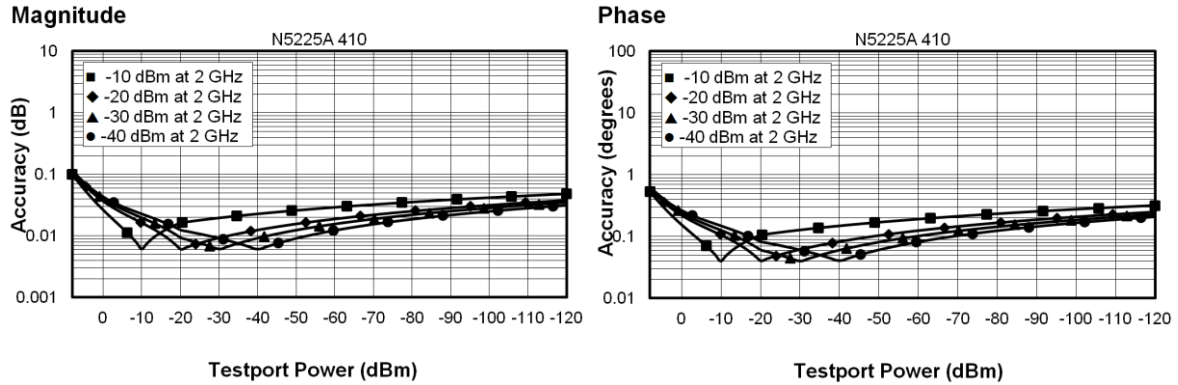

## N5224A/25A Dynamic Accuracy, 20 GHz - Specification

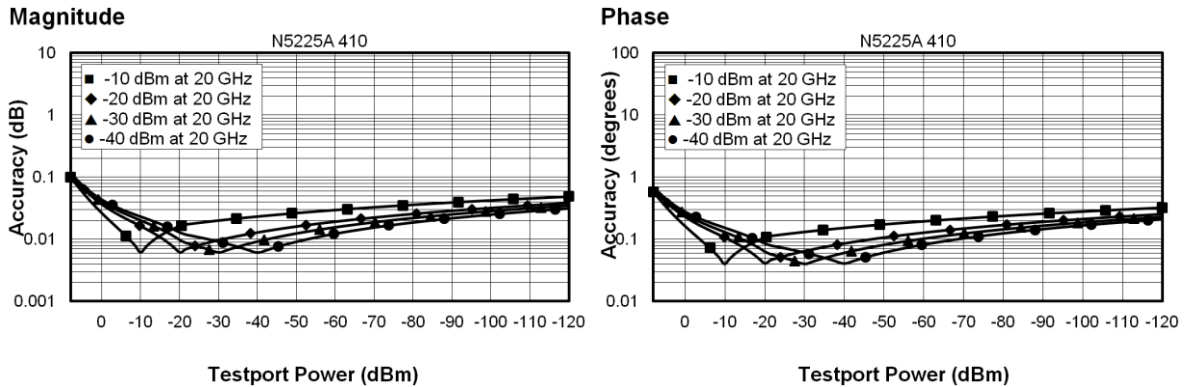

## N5224A/25A Dynamic Accuracy, 26.5 GHz - Specification

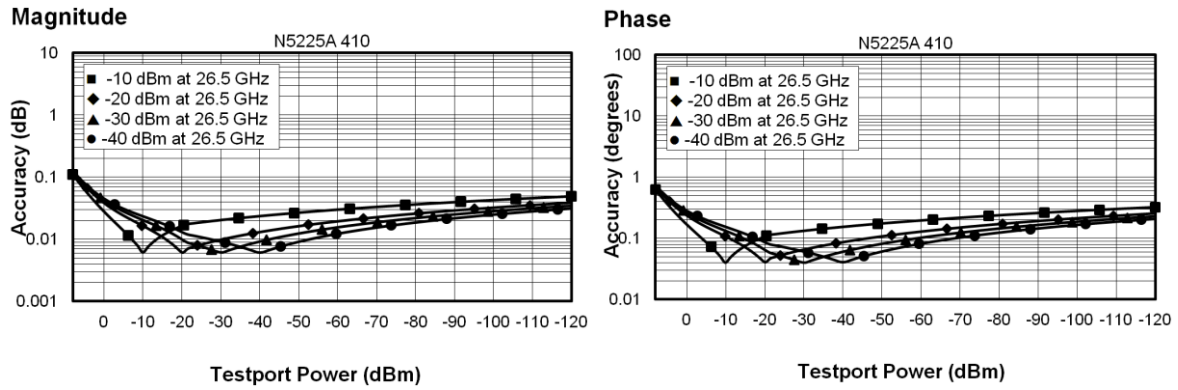

## N5224A/25A Dynamic Accuracy, 35 GHz - Specification

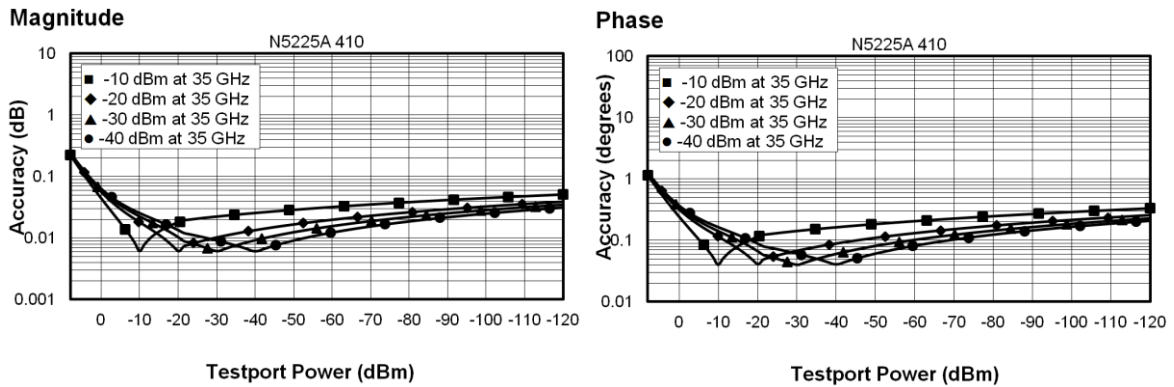

## N5224A/25A Dynamic Accuracy, 40 GHz - Specification

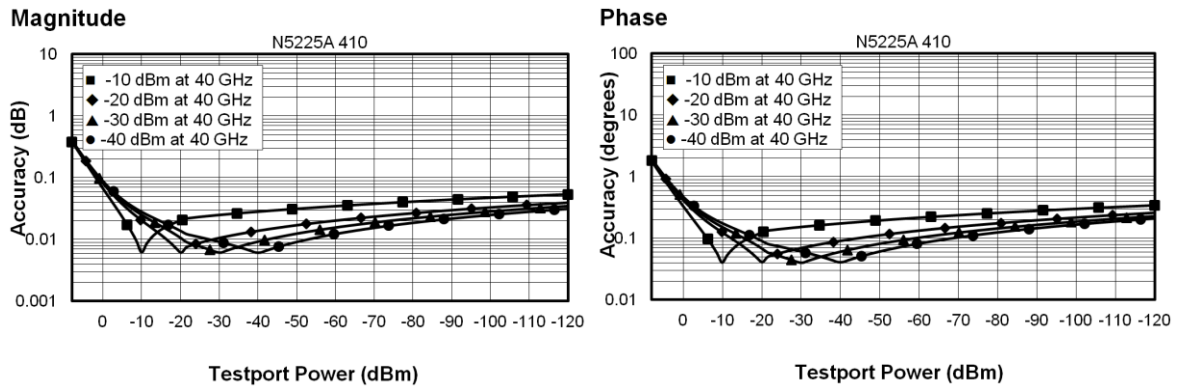

# N5224A/25A Dynamic Accuracy, 50 GHz - Specification

### Magnitude

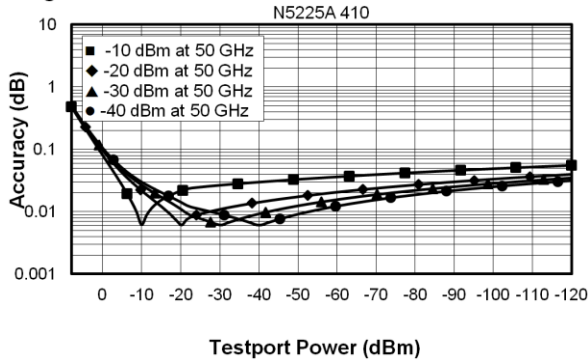

### Phase

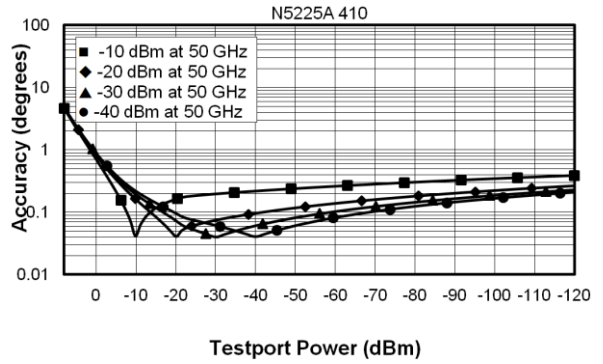

**Table 22. Group Delay - Typical**

Group delay is computed by measuring the phase change within a specified frequency step (determined by the frequency span and the number of points per sweep). In general, the following formula can be used to determine the accuracy, in seconds, of specific group delay measurement:

$$\pm \text{Phase Accuracy (deg)} / [360 \times \text{Aperture (Hz)}]$$

Depending on the aperture and device length, the phase accuracy used is either incremental phase accuracy or worst-case phase accuracy

Description	Typical Performance
Aperture (selectable)	(frequency span)/(number of points -1)
Maximum Aperture	20% of frequency span
Range	0.5 x (1/minimum aperture)
Maximum Delay	Limited to measuring no more than 180° of phase change within the minimum aperture.)

The following graphs show characteristic group delay accuracy with full 2-port calibration and a 10 Hz IF bandwidth. Insertion loss is assumed to be < 2 dB and electrical length to be ten meters.

For any  $S_{ij}$  Group Delay measurement,  $S_{ii} = 0$ ,  $S_{ij} = 1$ ,  $S_{ji} = 0$ ,  $S_{kl} = 0$  for all  $kl \neq ij$

### Group Delay (Typical)

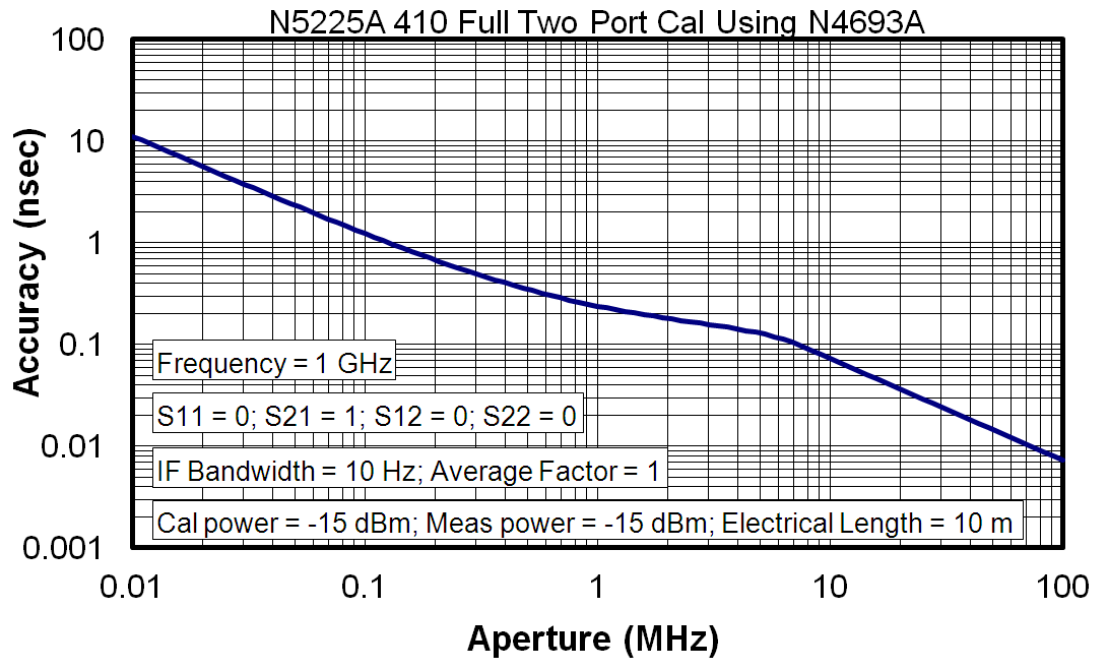

## General Information

- Miscellaneous Information
- Front Panel
- Rear Panel
- Environment and Dimensions

Table 23. Miscellaneous Information

Description	Supplemental Information
System IF Bandwidth Range	1 Hz to 15 MHz, nominal
CPU	For the latest information on CPUs and associated hard drives, visit: <a href="http://na.support.keysight.com/pna/hdnumbers.html">http://na.support.keysight.com/pna/hdnumbers.html</a>
LXI	Class C

Table 24. Front Panel Information, Option 210, 410

Description	Typical Performance
<b>RF Connectors</b>	
Type	2.4 mm (male), 50 ohm, (nominal)
Center Pin Recession	0.002 in. (characteristic)
<b>USB 2.0 Ports - Master (4 ports)</b>	
Standard	Compatible with USB 2.0
Connector	USB Type-A female
<b>Display</b>	
Size	26.3 cm (10.4 in) diagonal color active matrix LCD; 1024 (horizontal) X 768 (vertical) resolution
Refresh Rate	Vertical 60 Hz; Horizontal 46.08 kHz
Pixels	Any of the following would cause a display to be considered faulty: <ul style="list-style-type: none"> <li>• A complete row or column consists of “stuck” or “dark” pixels.</li> <li>• More than six “stuck on” pixels (but not more than three green) or more than 0.002% of the total pixels are within the LCD specifications.</li> <li>• More than twelve “dark” pixels (but no more than seven of the same color) or more than 0.004% of the total pixels are within the LCD specifications.</li> <li>• Two or more consecutive “stuck on” pixels or three or more consecutive “dark” pixel (but no more than one set of two consecutive dark pixels)</li> <li>• “Stuck on” “dark” pixels are less than 6.5 mm apart (excluding consecutive pixels)</li> </ul>

Table 24. (Continued) Front Panel Information, Option 210, 410

Description	Typical Performance
<b>Display Range</b>	
Magnitude	+/-2500 dB (at 500 dB/div), max
Phase	+/-2500° (at 500 degrees/div), max
Polar	10 pUnits, min 10,000 Units, max
<b>Display Resolution</b>	
Magnitude	0.001 dB/div, min
Phase	0.01°/div, min
<b>Marker Resolution</b>	
Magnitude	0.001 dB, min
Phase	0.01°, min
Polar	10 pUnit, min

Table 25. Rear Panel Information, Option 210, 410

Description	Typical Performance
<b>10 MHz Reference In</b>	
Connector	BNC, female
Input Frequency	10 MHz ± 10 ppm
Input Level	-15 dBm to +20 dBm
Input Impedance	200 Ω, nom.
<b>10 MHz Reference Out</b>	
Connector	BNC, female
Output Frequency	10 MHz ± 1 ppm
Signal Type	Sine Wave
Output Level	+10 dBm ± 4 dB into 50 Ω
Output Impedance	50 Ω, nominal
Harmonics	<-40 dBc, typical

Table 25. (Continued) Rear Panel Information, Option 210, 410

Description	Typical Performance
<b>External IF Inputs</b>	
Function	Allows use of external IF signals from remote mixers, bypassing the PNA's first converters
Connectors	SMA (female); A, B, C, D, R (4-port); A, B, R1, R2 (2-port)
Input Frequency	
Normal IF path	RF < 53 MHz: IF = 826.446 KHz RF >= 53 MHz: IF = 7.438 MHz
Narrowband IF path	IF = 10.70 MHz
Input Impedance	50 $\Omega$
RF Damage Level	+23 dBm
DC Damage Level	5.5 VDC
0.1 dB Compression Point	
Normal IF path	-9.0 dBm at 7.438 MHz
Narrowband IF path	-17 dBm at 10.70 MHz
<b>Pulse Inputs (IF Gates)</b>	
Function	Internal receiver gates used for point-in-pulse and pulse-profile measurements
Connectors	15-pin mini D-sub
Input Impedance	1 K Ohm
Minimum Pulse Width, Source Modulators	33 ns
Minimum Pulse Width, Receiver Gates	20 ns
DC Damage Level	5.5 VDC
Drive Voltage	0 V (off), +3.3 V (on), nominal
<b>RF Pulse Modulator Input (Source Modulator)</b>	
<b>On/Off Ratio</b>	
10 MHz to 3.2 GHz	-64
3.2 GHz to 50 GHz	-80
<b>Pulse Period</b>	
Minimum	33 ns
Maximum	70 s



Table 25. (Continued) Rear Panel Information, Option 210, 410

Description	Typical Performance	
<b>Pulse Outputs</b>		
Voltage (TTL)	High: 3.3V to 3.5V Low: <1V	
Impedance	50 Ohm	
<b>External Test Set Driver</b>		
Function	Used for driving remote mixers	
Connections	3.5 mm (female)	
RF Output Frequency Range	3.2 GHz to 19 GHz	
LO Output Frequency Range	1.76 GHz to 26.5 GHz	
<b>Rear Panel LO Power<sup>1</sup></b>		
	<b>Upper Limit, Typical (dBm)</b>	<b>Lower Limit, Typical (dBm)</b>
1.7 GHz to 6.78 GHz	5	-3
6.78 GHz to 15.4 GHz	0	-6
15.4 GHz to 26.5 GHz	4	-5
<b>Rear Panel RF Power</b>		
	<b>Upper Limit, Typical (dBm)</b>	<b>Lower Limit, Typical (dBm)</b>
3.2 GHz to 19 GHz	-3	-8
<b>Devices Supported</b>		
	<b>Resolutions</b>	
Flat Panel (TFT)	1024 X 768, 800 X 600, 640 X 480	
Flat Panel (DSTN)	800 X 600, 640 X 480	
CRT Monitor	1280 X 1024, 1024 X 768, 800 X 600, 640 X 480	
Simultaneous operation of the internal and external displays is allowed, but with 640 X 480 resolution only. If you change resolution, you can only view the external display (internal display will "white out").		

<sup>1</sup> LO output available in full analyzer's frequency range. The power is tested only from 3.2 GHz to 26.5 GHz.

Table 25. (Continued) Rear Panel Information, Option 210, 410

<b>Description</b>	<b>Typical Performance</b>
Trigger Inputs/Outputs	BNC(f), TTL/CMOS compatible
Test Set IO	25-pin D-Sub connector, available for external test set control.
Power IO	9-pin D-Sub, female; analog and digital IO
Handler IO	36-pin parallel I/O port; all input/output signals are default set to negative logic; can be reset to positive logic via GPIB command.
Pulse I/O	15-pin D connector provides access to Pulse Modulators and Generators
GPIB	Two ports - dedicated controller and dedicated talker/listener. 24-pin D-sub (Type D-24), female; compatible with IEEE-488.
PCIe	Cabled PCIe x4 connector is a 4-lane slot (not currently used)
USB Ports	Two SuperSpeed USB ports (900 mA each), one USB port below LAN connector, and one USB device port. There are also four USB ports (500 mA each) on the front panel. The total current limit for all rear panel USB ports is 2.3 amps. The total current limit for all front panel USB ports is 2 amps.
LAN	10/100/1000 BaseT Ethernet, 8-pin configuration; auto selects between the data rates
VGA Video Output	15-pin mini D-Sub; Drives VGA compatible monitors
Mini DisplayPort	Miniature DisplayPort connector for connection to external displays
Line Power	
Frequency, Voltage	50/60/400 Hz for 100 to 120 VAC 50/60 Hz for 220 to 240 VAC
	Power supply is auto switching
Max	450 watts

Table 26. Analyzer Dimensions and Weight

All models are shipped with handles.

<b>Cabinet Dimensions</b>	<b>Metric (mm)</b>	<b>Imperial (inches)</b>
<b>Height</b>		
Without bottom feet: <sup>1</sup> EIA RU = 6	266.1	10.5
With bottom feet	279.1	11.0
<b>Width</b>		
Without handles or rack-mount flanges	425.6	16.8
With handles, without rack-mount flanges	458.7	18.1
With handles and rack-mount flanges	482.9	19.0
<b>Depth</b>		
Without front and rear panel hardware	582.3	22.9
With front and rear panel hardware, handles	649.6	25.6

<sup>1</sup>Electronics Industry Association rack units. 1 RU = 1.75 in.

See detailed PNA dimension drawings at: <http://na.tm.keysight.com/pna/PNADimensions.pdf>

<b>Weight (nominal)</b>	<b>Net</b>	<b>Shipping</b>
2-port model (Option 210)	39.1 kg (86 lb)	55 kg (121 lb)
4-port model (Option 410)	41.8 kg (92 lb)	58.2 kg (128 lb)

#### Regulatory and Environmental Information

For Regulatory and Environmental information, refer to the PNA Series Installation and Quick Start Guide, located online at <http://literature.cdn.keysight.com/litweb/pdf/E8356-90001.pdf>.

## Measurement Throughput Summary

- Typical Cycle Time for Measurement Completion
- Cycle Time vs. IF Bandwidth
- Cycle Time vs. Number of Points
- Data Transfer Time

Cycle time Includes sweep time, retrace time and band-crossing time. Analyzer display turned off with DISPLAY:ENABLE OFF. Add 21 ms for display on. Data for one trace (S<sub>11</sub>) measurement.

Table 27a. Typical Cycle Time (ms) for Measurement Completion, All Models and Options

Sweep Range	IF Bandwidth		Number of Points				
			201	401	1601	16001	32001
9 GHz to 10 GHz	600 kHz	Uncorrected	5.5	5.5	9.4	59.4	116
		2-Port cal	17.2	18.0	16.6	132	250
	10 kHz	Uncorrected	28.1	53.1	203	1995	3988
		2-Port cal	65.6	116	414	4003	7991
	1 kHz	Uncorrected	227	445	1744	17028	33828
		2-Port cal	461	898	3150	30669	67680
10 GHz to 20 GHz	600 kHz	Uncorrected	17.2	18.8	23.4	68.8	120
		2-Port cal	43.8	46.9	56.3	155	259
	10 kHz	Uncorrected	67.2	127	259	2003	3995
		2-Port cal	144	261	523	4016	8003
	1 kHz	Uncorrected	233	456	1781	17375	34516
		2-Port cal	475	922	3570	34758	69055

Table 27b. N5224A/25A Typical Cycle Time (ms) for Full-Span Measurement Completion

<b>10 MHz to 13.5 GHz</b>		<b>Number of Points</b>				
<b>IF Bandwidth</b>		<b>201</b>	<b>401</b>	<b>1601</b>	<b>16001</b>	<b>32001</b>
600 kHz	Uncorrected	48.4	59.4	78.1	156	206
	2-Port cal	105	127	164	317	428
10 kHz	Uncorrected	84.4	147	505	2172	4188
	2-Port cal	175	302	1016	4350	8384
1 kHz	Uncorrected	250	477	1822	17617	34984
	2-Port cal	505	959	3647	35250	69992

Table 27c. N5224A/25A Typical Cycle Time (ms) for Full-Span Measurement Completion

<b>10 MHz to 26.5 GHz</b>		<b>Number of Points</b>				
<b>IF Bandwidth</b>		<b>201</b>	<b>401</b>	<b>1601</b>	<b>16001</b>	<b>32001</b>
600 kHz	Uncorrected	55.5	67.2	85.9	166	223
	2-Port cal	116	141	175	334	443
10 kHz	Uncorrected	87.5	151	512	2182	4203
	2-Port cal	180	307	1027	4364	8422
1 kHz	Uncorrected	252	480	1825	17648	35031
	2-Port cal	509	966	3656	35305	70086

**Table 28. Cycle Time vs. IF Bandwidth - Typical**

Applies to the Preset condition (201 points, correction off) except for the following changes:

- CF = 10 GHz
- Span = 100 MHz
- Display off (add 21 ms for display on)

Cycle time includes sweep and retrace time.

<b>Description</b>		<b>N5224A/25A</b>
<b>IF Bandwidth (Hz)</b>	<b>Cycle Time (ms)</b>	<b>Trace Noise Magnitude (dB rms)</b>
600,000	5.5	0.005
100,000	5.5	0.0024
30,000	8.6	0.0017
10,000	28.9	0.0014
3,000	70.3	0.001
1,000	223	0.0008
300	642	0.0006
100	1823	0.0005
30	5977	0.0005
10	17836	0.0005
3	59289	0.0004

**Table 29. Cycle Time vs. Number of Points - Typical**

Applies to the Preset condition (correction off) except for the following changes:

- CF = 10 GHz
- Span = 100 MHz
- Display off (add 21 ms for display on)

Cycle time includes sweep and retrace time.

Description	IF Bandwidth (Hz)			
	1,000	10,000	30,000	600,000
3	6.3	4.7	4.7	4.7
11	15.6	5.5	4.7	4.7
51	59.4	10.2	4.7	4.7
101	113	15.6	6.3	4.7
201	222	28.1	8.6	4.7
401	436	53.1	14.1	5.5
801	859	103	23.4	6.3
1,601	1706	203	43.8	9.4
6,401	6719	800	166	26.6
16,001	16656	1995	408	60.2
32,001	33086	3988	812	116

**Table 30. Data Transfer Time (ms) - Typical**

Measured with the analyzer display off.

Values will increase slightly if the analyzer display is on.

Description	Number of Points				
	201	401	1601	16,001	32,001
<b>SCPI over GPIB</b> (Program executed on external PC <sup>2</sup> )					
32-bit floating point	4.6	9.3	38	352	720
64-bit floating point	9.4	18.8	73.4	730	1455
ASCII	36.7	72.5	288	2882	5762
<b>SCPI over SICL/LAN or TCP/IP Socket</b> <sup>1</sup> (Program executed in the analyzer)					
32-bit floating point	<1	<1	<1	1.2	2.4
64-bit floating point	<1	<1	<1	2.3	4.6
ASCII	2.1	4	15	148	295
<b>COM</b> <sup>1</sup> (Program executed in the analyzer)					
32-bit floating point	<1	<1	<1	<1	<1
Variant type	<1	<1	1.4	12.4	25.5
<b>DCOM over LAN</b> <sup>1</sup> (Program executed on external PC)					
32-bit floating point	<1	<1	<1	2.3	4.4
Variant type	<1	1.6	5.3	52	105.5

<sup>1</sup> Values are for real and imaginary pairs, with the analyzer display off, using Gigabit Ethernet.

**NOTE**

Specifications for Recall & Sweep Speed are not provided for the N522xA analyzers.



# Test Set Block Diagrams

**NOTE** For best readability, use a color printer for printing the following graphics.

## Legend

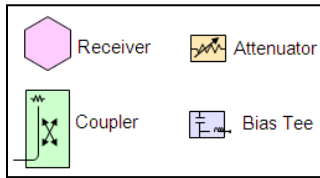

N5224A and N5225A Option 210 (2-port metrology configuration)

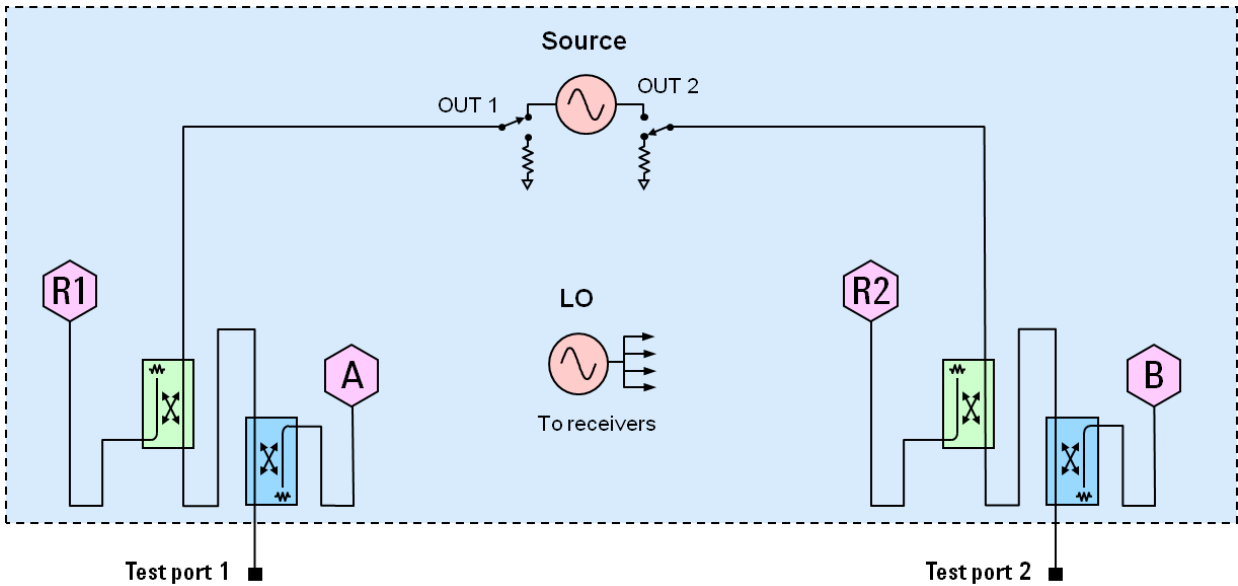

N5224A and N5225A Option 410 (4-port metrology configuration)

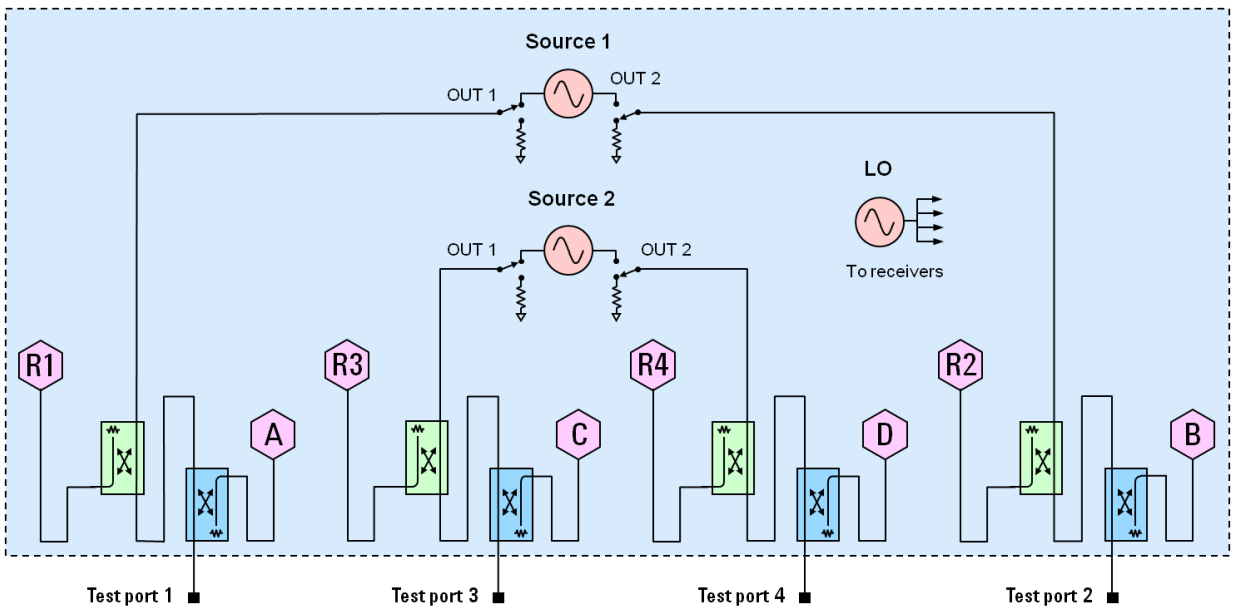

# Receiver Block Diagram

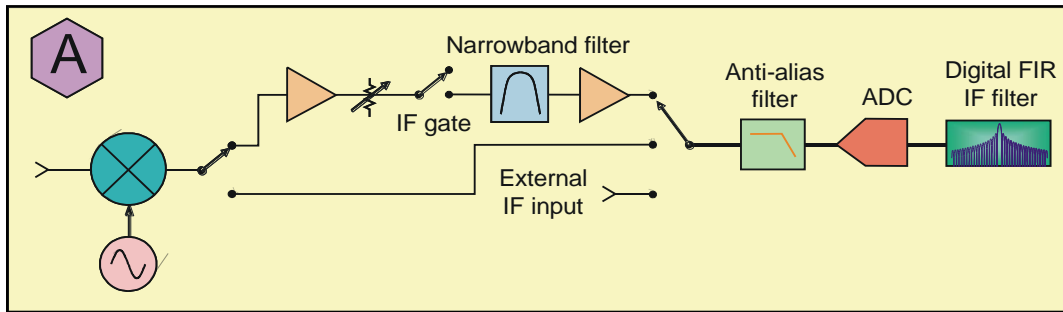



This information is subject to change without notice.

© Keysight Technologies 2014-2018

Print Date: October 30, 2018



N5224-90002

[www.keysight.com](http://www.keysight.com)