

Keysight X-Series Signal Analyzers

N9094AK Processor Assembly Upgrade Windows 10

Notice: This document contains references to Agilent. Please note that Agilent's Test and Measurement business has become Keysight Technologies. For more information, go to www.keysight.com.

Notices

© Copyright 2018 Keysight Technologies, Inc.

The information contained in this document is subject to change without notice.

Keysight Technologies makes no warranty of any kind with regard to this material, including but not limited to, the implied warranties of merchantability and fitness for a particular purpose.

Keysight Technologies shall not be liable for errors contained herein or for incidental or consequential damages in connection with the furnishing, performance, or use of this material.

Manual Part Number

N9094-90004

Edition

Edition 1, March 2018

Printed in USA/Malaysia

Published by:

Keysight Technologies, Inc.
1400 Fountaingrove Parkway
Santa Rosa, CA 95403

Processor Assembly Upgrade

Products Affected:	EXA N9010A MXA N9020A PXA N9030A MXE N9038A
Requirements:	None
To Be Performed By:	(X) Keysight Service Center (X) Advanced User () User
Estimated Installation Time:	1.0 Hours
Estimated Adjustment and Verification Time:	0 Hours

This document provides detailed instructions for the installation of an upgraded processor assembly in an X-Series Signal Analyzer. Please be sure to read this entire document before attempting to put this upgraded processor into use.

Contents

Quantity	Description
1	Installation Note
1	Processor Board Assembly with Programmed Solid State Disk Drive Assembly
1	Option Upgrade Entitlement Certificate ^a

a.not included for MXE

Tools Required

- Torx Driver T-10
- USB Mouse
- USB Keyboard
- USB storage device with > 2 GB free memory

What you will find in this Document

Overview	page 5
Instrument Configuration Data	page 5
Instrument Calibration Data	page 5
User Data	page 5
Miscellaneous Considerations	page 6
Installation Instructions	page 7
Calibration Data Backup and Restore	page 9
Data Backup.....	page 9
S/W Revision Less Than A.01.55.....	page 9
S/W Revision Greater Than or Equal To A.01.55 and Less Than A.02.00	page 10
S/W Revision Greater Than A.02.00.....	page 11
Data Restore to Replacement Processor	page 12
License Key Backup and Restore	page 13
Installing N9060B License Key	page 15
Alternate Installation Procedure.....	page 16
Verify the Installation	page 16
Processor Assembly Removal and Installation	page 17
Removal.....	page 17
Installation	page 17
Initializing the Instrument Operating System	page 18
Software Updates.....	page 21
FPGA Code Compatibility	page 21
FPGA Code Update	page 22
Updating the Instrument FPGA Code	page 22
BIOS Setting Verification	page 23
Verifying Boot Priority.....	page 23
Adjustments and Performance Verification	page 24
Adjustments Required	page 24
Performance Testing Required.....	page 24

Overview

This option provides an upgraded central processing unit (CPU) as well as a removable solid state disk drive. This option could have been purchased for one of the following reasons:

1. To upgrade the instrument CPU.
2. To upgrade the instrument operating system when a CPU upgrade is also required

While there may be other reasons to have purchased this processor upgrade, this document will specifically cover the requirements needed for putting this new processor into use for the reasons listed above.

Instrument Configuration Data

The instrument model and serial numbers will not need to be transferred to the new disk drive while performing this upgrade, as the master copy of all of these is stored on the instrument A7 Midplane board assembly and will be automatically copied to the new disk drive when the instrument first boots up.

Instrument Calibration Data

With the disk drive being replaced the instrument calibration data will need to be transferred to the new disk drive during this upgrade process. Once the instrument calibration data has been transferred to the new disk drive the instrument performance will remain as it was prior to the upgrade.

NOTE

Should an incorrect version of the X Series calibration file be installed in an instrument, no error messages will be displayed. The instrument may however perform outside of the warranted specifications for that instrument. It is therefore extremely important to ensure that the instrument specific calibration data is properly copied onto this drive before the instrument is used for making any measurements.

License Keys

In most cases, the license keys stored on the Midplane board assembly will be automatically copied to the new disk drive when the instrument first boots up. However, this cannot always be guaranteed to occur. Therefore, the license keys will also be backed up from the original disk drive so they can later be restored to the new disk drive.

User Data

This upgrade procedure does not cover the transferring of any user data from the existing disk drive to the new one. It is up to the end user to have backed up their data before sending it in for servicing.

Miscellaneous Considerations

Before using this processor assembly upgrade in any instrument there are two areas of concern that will need to be addressed.

1. The new disk drive included with this upgrade will have been shipped with the currently shipping version of the instrument software, which may be a different version from what is currently being used in the instrument for which it was purchased.

While an instrument may function properly with different software versions, the software stored on the different measurement boards within the instrument (FPGA code) may not be compatible with both versions. Also, the factory calibration data file used by the different instrument software versions could be incompatible.

2. The new disk drive included with this upgrade will have been shipped with a default factory calibration data file. Before using this drive the instrument specific calibration data file will need to be copied to it.

Even if the instrument software version that the new disk drive was shipped with is the same as what is in the instrument the instrument specific factory calibration data will still need to be copied and transferred onto the new disk drive.

Following the instructions included in this document closely will ensure that this new processor assembly will be properly configured for operation in the instrument being upgraded.

Installation Instructions

This section will outline what steps are required to properly configure the new processor assembly **before** putting it into use.

1. Power the instrument on and verify that it will not only boot up, but that the instrument application software will load properly. This would include verifying that there are no error messages displayed in the Status Bar of the application window.

If there are any problems with the instrument at this point, including the presence of any error messages, either repair the instrument prior to proceeding with this upgrade or make detailed notes of the instrument status in the space provided below and address them once this upgrade has been completed if they persist.

2. With the original processor assembly still installed in the instrument, determine what version of the instrument software is currently installed on it. For instructions on how to verify the currently installed software version see the **Software Updates** section in this document for instructions. Record the currently installed software version below.

Instrument S/W Revision: _____

3. Backup the instrument factory calibration data to a USB storage device. See the **Calibration Data Backup and Restore** section in this document for instructions.
4. Backup the license keys to a USB storage device. See the **“License Key Backup and Restore”** section in this document for instructions.
5. If an option upgrade entitlement certificate was included with this upgrade, redeem and install the license. See the **Installing N9060B License Key** section in this document for instructions.
6. Replace the original processor assembly with the assembly supplied with this kit. See the **Processor Assembly Removal and Installation** section in this document for instructions.
7. Turn the instrument on with the new processor assembly installed and see the **Initializing the Instrument Operating System** section in this document for instructions.
8. Ignore any hardware related error messages that might appear at this time, as they may be related to software version incompatibilities that will be resolved in the following steps of this procedure.
9. Restore the license keys that were previously backed up from the original processor assembly. See the **“License Key Backup and Restore”** section in this document for instructions.
10. Determine what version of the instrument software is currently installed on the new processor assembly. Record the installed software version below.

Instrument S/W Revision: _____

11. Compare the instrument software revision as recorded in [step 10](#) to that which was recorded in [step 2](#).
12. If the instrument software versions are exactly the same skip to [step 13](#) in this procedure.

If the instrument software revision recorded in [step 10](#) is older than that which was recorded in [step 2](#) update the instrument software on the new processor assembly to the latest version. See the [Software Updates](#) section of this document for instructions on how to obtain and install the latest instrument software revision

If the instrument software revision recorded in [step 10](#) is newer than that which was recorded in [step 2](#) update the instrument FPGA code. See the [FPGA Code Update](#) section in this document for instructions on how this is done.
13. Restore the instrument factory calibration data that was previously backed up from the original processor assembly. See the [Calibration Data Backup and Restore](#) section in this document for instructions.

If for some reason the instrument calibration data could not be successfully backed up and restored to the new processor assembly all of the instrument adjustments and performance verification testing must be performed to ensure that the instrument meets is specified performance parameters. See the [Adjustments and Performance Verification](#) section of this document for instructions on how this is done.
14. Verify that the BIOS settings of the new processor assembly are configured properly. See the [BIOS Setting Verification](#) section of this document for instructions on how this is done.
15. Cycle the instrument power and verify that the instrument will not only boot up, but that the signal analyzer application software will load properly. This would include verifying that there are no error messages displayed in the Status Bar of the application window.
16. The replacement processor contains an internal SD memory card, and it is necessary to create a backup of the calibration data to this SD card. Refer to the [“Calibration Data Backup to SD Card”](#) section on [page 25](#) of this document for instructions on how this is done.
17. The instrument is now ready for use.

Calibration Data Backup and Restore

In order for the instrument being upgraded to not need all of the instrument adjustments and performance verification tests to be run after this upgrade is completed the calibration data will need to be backed up onto an external drive prior to removing the existing processor / disk drive assembly.

NOTE

While the backing up and restoring of the calibration data to the new disk drive will return the instrument performance to the state that it was prior to this upgrade this does not guarantee that all instrument performance parameters meet their specified values. A full instrument calibration would be required to verify this.

Data Backup

There are three different backup procedures that might need to be followed. Which backup procedure to be run will depend on the software version that currently exists in the instrument being upgraded.

To determine which calibration data backup procedure needs to be run compare the current instrument software version that was recorded in the **Installation Instructions** section **step 2** of this document and follow the steps outlined below for that version.

S/W Revision Less Than A.01.55

Instruments with a software version older than A.01.55 will first need to have the software updated to the latest version prior to being able to backup the instrument calibration data. See the **Software Updates** section of this document for instructions on updating the instrument software.

Once the software has been updated, use the calibration data backup procedure under the heading "S/W Revision Greater Than A.02.00."

S/W Revision Greater Than or Equal To A.01.55 and Less Than A.02.00

1. Close the instrument application software by pressing **File, Exit, Enter**.
2. Connect a USB mouse to one of the instrument USB ports.
3. Connect a USB memory device to another instrument USB port.
4. Using the mouse select **Start, My Computer** and navigate to the following folder:
C:\Program Files\Agilent\SignalAnalysis\Physics
5. Double-click on **BackupAndRestore.exe** and the window shown in **Figure 1** will appear.

Figure 1 Calibration Data Backup

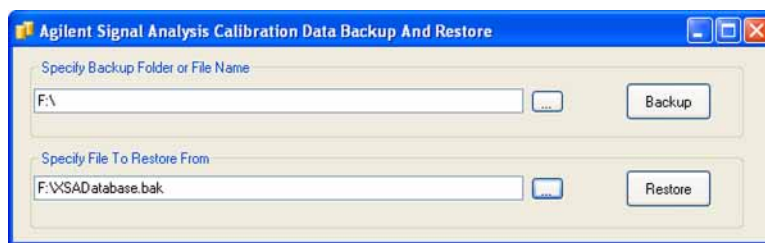

6. Under the “Specify Backup Folder or File Name” use the mouse to select the “...” button to open the “Browse For Folder” dialog box.
7. Select the USB memory device and press **OK**.

NOTE

While you can use the “Make New Folder” button in the “Browse For Folder” dialog box to create a sub-folder on the USB memory device, and you can specify a filename in the “Specify Backup Folder or File Name” window, you can also just use the root directory on the drive and let the instrument select a default filename for you.

8. Select **“Backup”** and wait for confirmation that the calibration database has been backed up.
9. When the backup has completed close the Calibration Data Backup And Restore window. The file will be saved with a .bak file suffix.

S/W Revision Greater Than A.02.00

1. With the instrument turned on and the signal analyzer application running as normal, connect a USB mouse to one of the instrument USB ports.
2. Connect a USB memory device to one of the instrument USB ports.
3. Press **System, Alignments, Backup or Restore Align Data**.
4. The Alignment Data Wizard window as shown in **Figure 2** will appear.

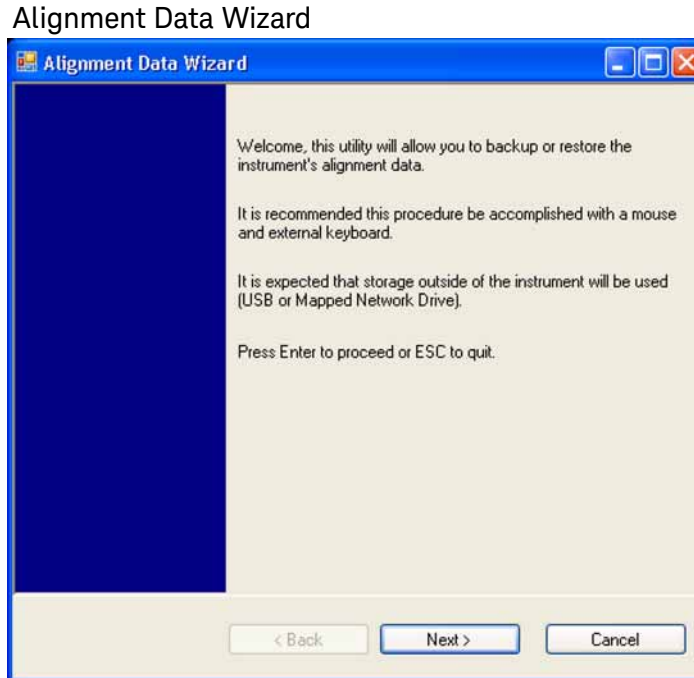
Figure 2

5. Follow the on-screen instruction to **Backup** the calibration data to the USB memory device. The file will be saved with a .bak file suffix.

Data Restore to Replacement Processor

1. With the instrument turned on and the signal analyzer application running as normal, connect a USB mouse to one of the instrument USB ports.
2. Connect the USB memory device that was earlier used to backup the instrument calibration data to one of the instrument USB ports.
3. Press **System, Alignments, Backup or Restore Align Data**.
4. If prompted for administrator password, enter Keysight4u!.
5. Click **OK** to close the analyzer program.
6. The Alignment Data Wizard window as shown in **Figure 2** will appear.
7. Follow the on-screen instruction to **Restore** the calibration data from the USB memory device.

No matter how the instrument calibration data was backed up prior to this upgrade, any further backing up of the data will now be done through the instrument's Alignment Data Wizard.

License Key Backup and Restore

In order for the instrument being upgraded to keep the same option configuration that it had prior to the upgrade, it is mandatory that the licenses be transferred from the original disk drive to the new disk drive. In most cases, these licenses will be automatically copied from the Midplane board assembly. However, there may be instances where the automatic copying process will not work. Therefore, the license keys will also be backed up for later restoration on the new disk drive.

License Key Backup

1. Locate a USB storage device. Perform a virus scan on this device before use.
2. Create a folder on the USB storage device with the folder name “Licenses” followed by the model number and serial number of the analyzer being upgraded. For example, “Licenses_N9020A_MY49100101”
3. Insert the USB storage device into one of the instruments USB ports.
4. Using a mouse, navigate to the folder C:\Program Files\Agilent\licensing.
5. Change the folder’s properties so that hidden files can be viewed.
 - a. If the operating system is WinXP, click on Tools and select Folder Options. Select the View tab. In the Advanced Settings window, under Hidden files and folders, select "Show hidden files and folders".
 - b. If the operating system is Windows Embedded Standard 7 (WES7), click on Organize and select Folder and search options. Select the View tab. In the Advanced Settings window, under Hidden files and folders, select "Show hidden files and folders".
6. Copy the contents of the C:\Program Files\Agilent\licensing folder to the Licenses... folder created on the USB storage device.
 - a. To select all of the licenses in the folder, click on any of the licenses and then press Ctrl-A on the external keyboard.
 - b. To copy the selected files, press Ctrl-C.
 - c. Navigate to the “Licenses_...” folder on the USB storage device for the instrument being upgraded and press Ctrl-V to paste all the licenses into the folder.

License Key Restore

1. Insert the USB storage device containing the backed-up license key.
2. Navigate to the “Licenses_...” folder on the USB storage device that is for the instrument being upgraded.
3. Click on one of the licenses in the folder and press Ctrl-A to select all license key files.
4. Press Ctrl-C to copy all the selected license key files.
5. Navigate to the C:\Program Files\Agilent\licensing folder.
6. Press Ctrl-V to copy all the license key files to the ~\licensing folder.
7. As each license is installed, you will see a message saying “Successful License Installation” in the lower right corner of the instrument display.
8. If you see a “Feature Already Licensed” message for each of the licenses being restored in the lower right corner of the instrument display, this most likely indicates that the licenses had already been automatically copied from the Midplane board assembly and the License Key Restore process was not required.

Installing N9060B License Key

1. Locate the Option Upgrade Entitlement Certificate from the kit.
2. Redeem the Option Upgrade Entitlement Certificate by following the instructions on the Certificate.
3. After redeeming your Option Upgrade Entitlement Certificate you will receive an email with an attached License File.
4. Locate a USB storage device. Perform a virus scan on this device before use.
5. Save the License File to the root directory of the USB storage device.
6. Connect the USB storage device to one of the instrument USB ports. The instrument will detect the new hardware and may display the configuration menu shown in **Figure 3**. Press ESC and this window will go away.

Figure 3 USB Storage Device Configuration Menu



7. The instrument will automatically consume the License File. (This may take a few minutes) When the License File is consumed the Keysight License Manager will display a “Successful License Installation” message as shown in **Figure 4**.

Figure 4 Successful License Installation

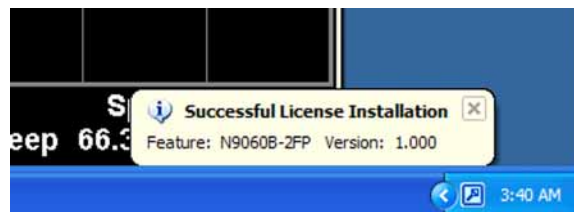

Processor Assembly Upgrade

Alternate Installation Procedure

The License File can be manually installed over USB or LAN by placing the license file in the following folder on the instrument

C:\Program Files\Agilent\licensing

Verify the Installation

1. Press **System, Show, System** to display a list of installed options.
2. Verify that the newly installed option number appears on the list.

Processor Assembly Removal and Installation

CAUTION

Electrostatic discharge (ESD) can damage or destroy electronic components. All work on electronic assemblies should be performed at a static-safe workstation. Refer to the documentation that pertains to your instrument for information about static-safe workstations and ordering static-safe accessories.

Removal

1. Turn off the instrument and remove the power cord from the rear panel.
2. Refer to **Figure 5**. Remove the existing CPU assembly from the instrument by removing the 6 rear panel screws (1). The CPU assembly can be removed from the chassis by using the two ejectors to pull it straight out the back.

Figure 5 CPU Assembly Removal

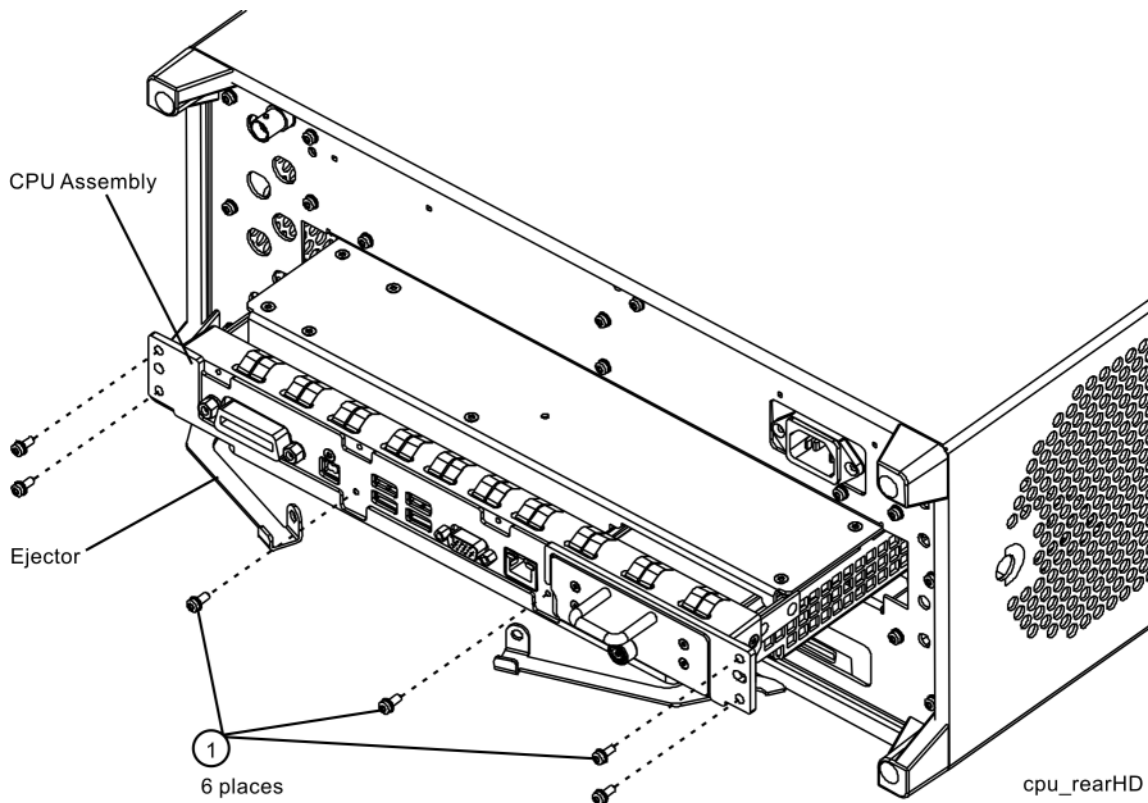

Installation

1. Refer to **Figure 5**. With the ejectors pulled out, slide the new CPU assembly into the slot at the rear of the instrument and push on the assembly to mate the connectors. Gently secure the CPU assembly to the instrument with the ejectors.
2. Replace the six screws (1) that attach the CPU assembly to the chassis. Torque to 9 inch-pounds.

Initializing the Instrument Operating System

NOTE

During the initial power-on process, the instrument may turn itself off and restart a number of times. This is normal and only happens during the initial installation process.

1. Connect a mouse to one of the instrument USB ports.

NOTE

This process may take 20 minutes to complete.

2. The Keysight Technologies screen appears followed by a screen that automatically loads the operating system.
3. The License Agreement dialog box as shown in **Figure 6** appears, providing information regarding the instrument software licensing.

Figure 6 License Agreement Dialog Box

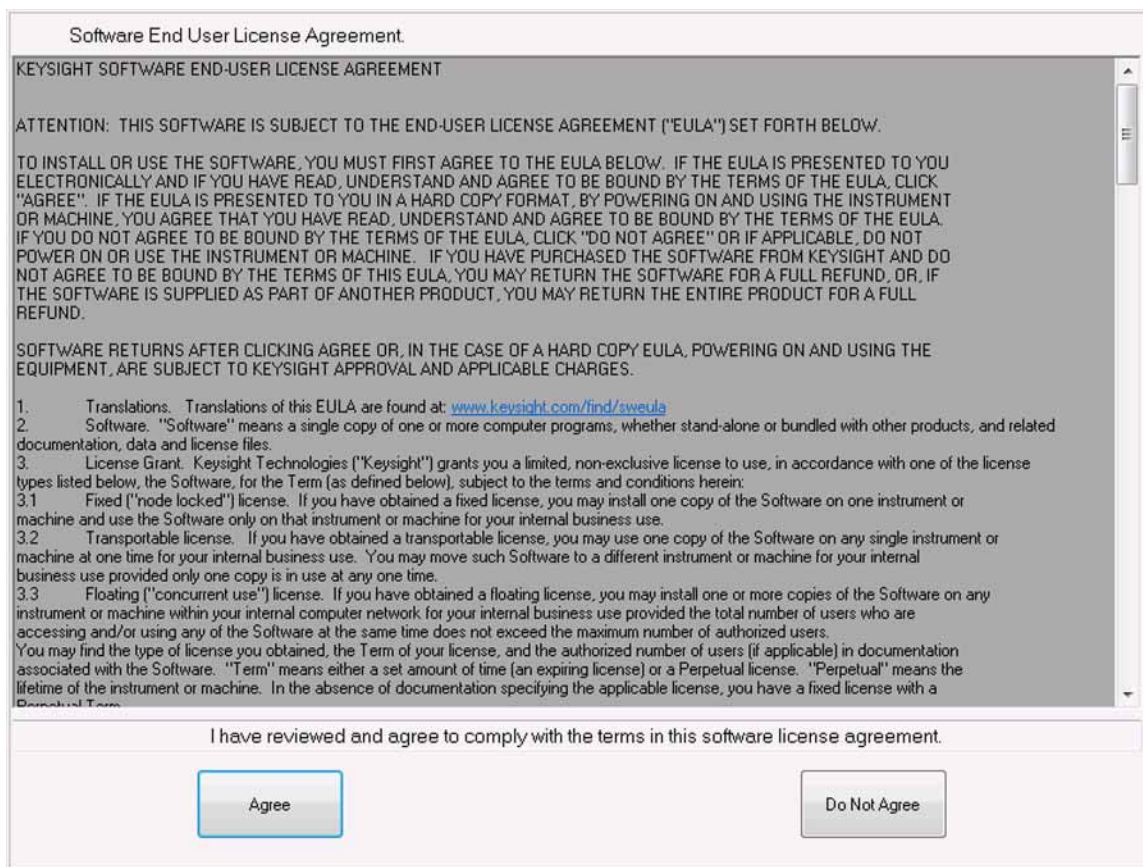

Select **Agree** to continue, or **Do Not Agree** to turn off the instrument before initializing the software.

CAUTION

After launching the setup, do not turn off the instrument or remove power before the setup routine completes and the system restarts. Turning off the instrument may corrupt the system and the instrument software may need to be recovered.

4. Several windows appear regarding getting devices ready and first boot customizations.
5. A message may appear that more recent calibration data is available. Select Yes and follow on-screen prompts to load data from back up file.
6. After the instrument restarts, a status window as shown in **Figure 7** appears while the instrument application software loads:

Figure 7 Application Launch Status Window

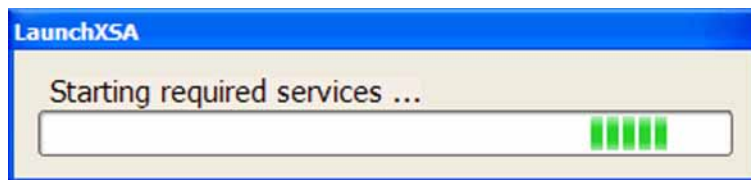

7. The anti-virus notification as shown in **Figure 8** will then appear.

Figure 8 Anti-Virus Message

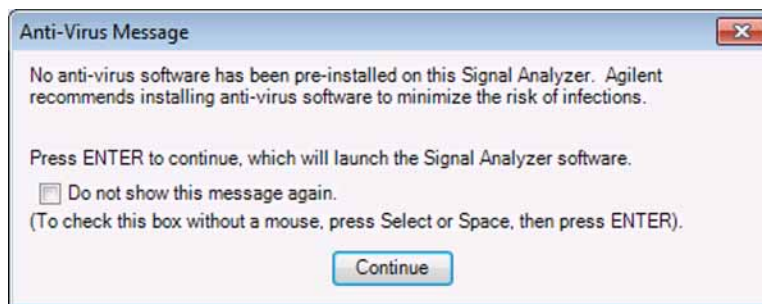
**NOTE**

If you do not check the “Do not show this message again” check box, this message will be displayed each time the instrument is turned on. No application will start while this message is displayed. Before continuing, make sure that you carefully read the Anti-Virus message and determine what action is appropriate.

8. Select Continue.

9. Once the instrument application software completes loading the instrument initialization will be completed.

A screen will appear as shown in **Figure 9**. The instrument may reboot one more time, and then the initialization will be complete.

Figure 9 Instrument Initialization

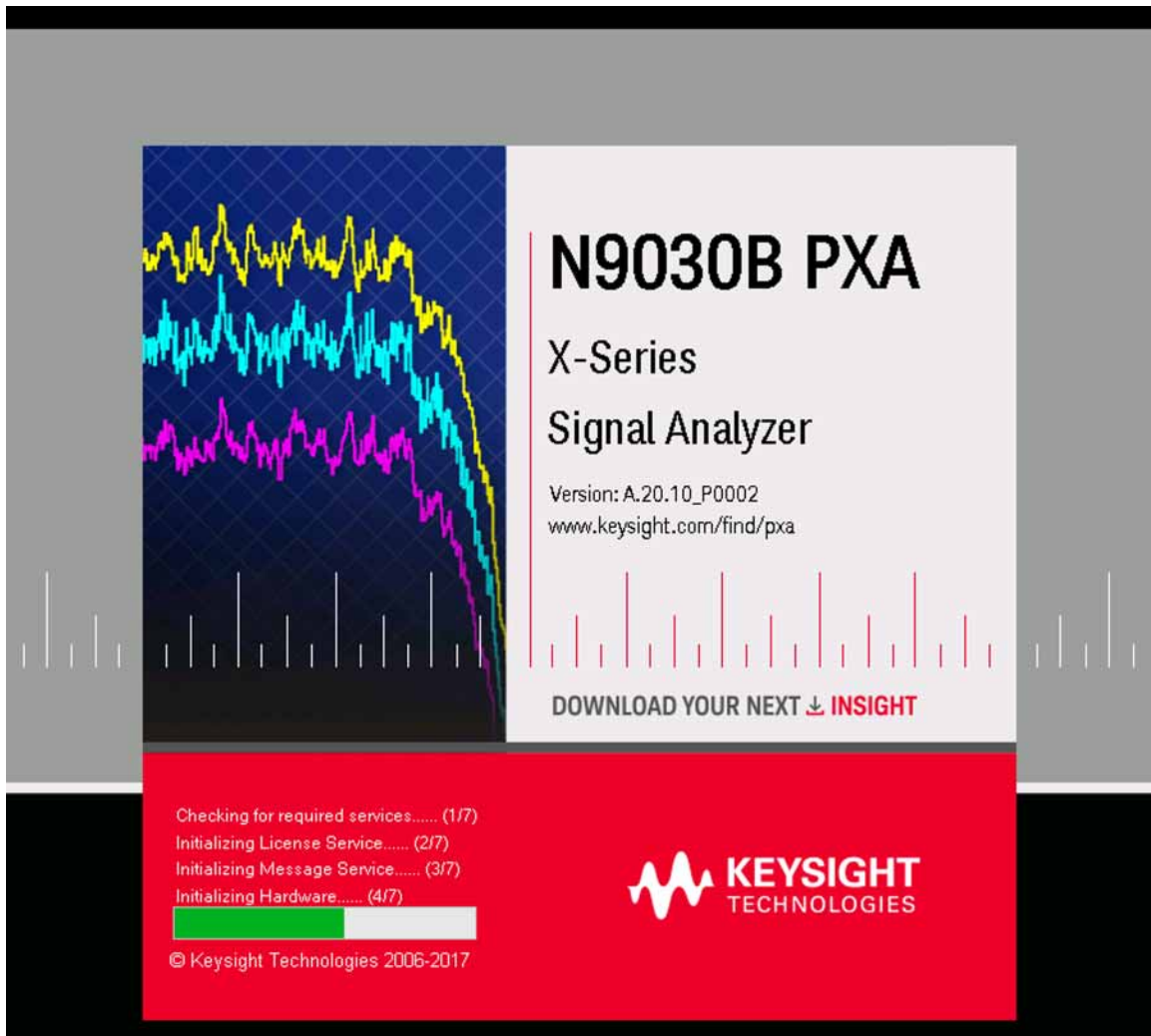

Software Updates

The currently installed instrument software version can be easily determined by pressing the following front panel keys:

System, Show, System

The software revision can be found on this screen as the:

Instrument S/W Revision

Updating the Instrument Software:

If an instrument software update is required, the latest revision of the X-Series signal analyzer software may be downloaded from:

http://www.keysight.com/find/xseries_software

FPGA Code Compatibility

One of the main reasons that the instrument application software must be the same version on all disk drives used in a particular instrument, in addition to factory calibration data compatibility issues, is that there is FPGA program code on multiple assemblies inside the instrument that must be compatible with the version of instrument software being used. The only way to ensure compatibility for all disk drives is to use the same instrument application software on all drives.

FPGA Code Update

There is FPGA program code on many different assemblies inside of the instrument, and all of these must be a compatible version with the instrument software revision. In order to ensure that this requirement is met you need to either install the latest software version on all disk drives used with the instrument or run an FPGA update program. If this program detects that there are assemblies that need to be updated it will update them to the correct version.

CAUTION

Once you start the FPGA programming process you **MUST NOT** interrupt the process for any reason. This would include turning the instrument off or unplugging the power cord to the instrument. Doing so will result in an inoperative instrument, requiring the affected assembly to be replaced.

Updating the Instrument FPGA Code

1. Connect a USB mouse and keyboard to available instrument USB ports.
2. Using the mouse, select **Start, My Computer**. Navigate to the following folder:
C:\Program Files\Agilent\SignalAnalysis\Physics
3. In this folder find and execute the file named:
FPGA_Prog.bat
4. The FPGA Programming Utility will start and a window as shown in **Figure 10** will appear.

Figure 10 FPGA Programming Utility

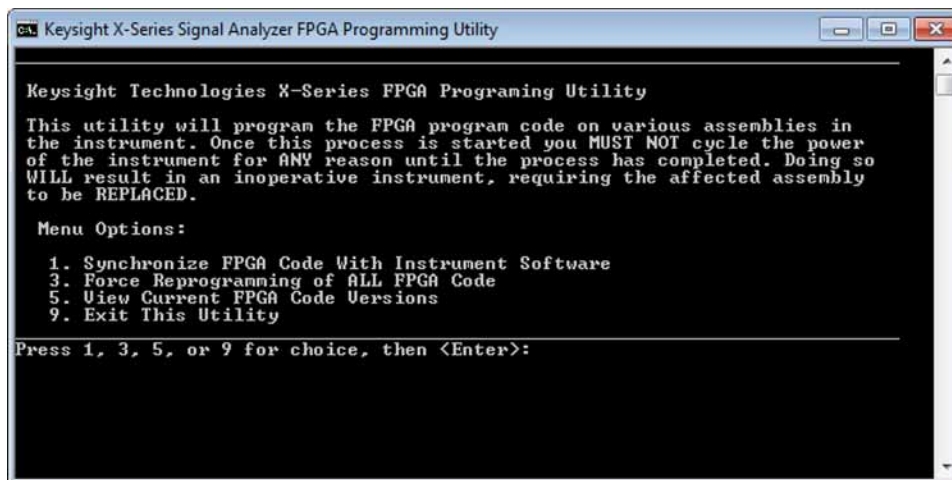

5. To program the FPGA code enter **1** and press **Enter**. You will need to confirm this selection by selecting **1** and **Enter** one more time.
6. The programming of the FPGA code could take a few minutes to complete. Once it has finished the instrument will reboot itself to use the new code.

BIOS Setting Verification

The default boot device used by the instrument CPU BIOS must be verified and may require changing when the CPU assembly is replaced. This setting needs to be correct in order for the instrument to always boot up correctly.

Since the different CPU assembly options available for the X-Series signal analyzers could have different CPU BIOS versions the exact instructions for each of these may be slightly different. However, the instructions below should give general enough directions needed to verify that this is correct for any version.

Verifying Boot Priority

1. Connect a USB keyboard and mouse to two of the instrument USB ports.
2. Turn the instrument power on.
3. Confirm Keysight Technologies splash screen comes up within a few seconds.
4. The splash screen should display instructions as to what key to press to enter the BIOS Setup utility. Press it while the Keysight Technologies splash screen is still displayed.
Typical key used to enter the BIOS Setup utility is: **Delete (DEL)**
5. Using the keyboard or instrument arrow keys navigate to the Boot tab in the BIOS Setup utility.
6. Verify that the #1 boot device is set to the internal instrument disk drive, Intel SSD for example, and not to a USB device.
7. Once the #1 boot device is set to the internal disk drive exit the BIOS Setup utility by selecting **Save & Exit** under the Exit tab.

Adjustments and Performance Verification

Adjustments and performance verification testing requires the use of the calibration software. The latest software information and downloads are available at:

<http://www.keysight.com/find/calibrationsoftware>

NOTE

The X-Series Signal Analyzer Calibration Files are located on the disk drive. Therefore, replacement of the disk drive will invalidate the current instrument calibration if the original calibration file has not been backed-up and restored. However, a full calibration is required to assure that the instrument meets all specifications. Arrangements regarding the level of calibration must be made between the end user and the calibration provider.

Adjustments Required

All (if the Calibration data file could not be backed-up and restored).

None (if the Calibration data file was backed-up and restored).

Performance Testing Required

All (if the Calibration data file could not be backed-up and restored).

None (if the Calibration data file was backed-up and restored).

Calibration Data Backup to SD Card

The PC6 and PC7 processor assemblies contain an internal SD card for the purpose of providing a location to back up the calibration data. After the PC6 or PC7 assembly is installed and the calibration data from the previously installed processor assembly has been restored (or after the appropriate adjustments have been performed if the previous calibration data could not be restored), another backup should be performed, this time to the SD card.

1. Remove any USB memory devices from the instrument.
2. With the instrument turned on and the signal analyzer application running as normal, press **System, Alignments, Backup or Restore Align Data**.
3. The Alignment Data Wizard window as shown in **Figure 2 on page 11** will appear.
4. Follow the on-screen instructions to backup the calibration data to the internal SD card, which will appear as the F: drive. The Alignment Data Wizard should default to F:/ Alignment Backup... The file will be saved with a .bak file suffix.
5. Create a directory if prompted.
6. Click **Save**.
7. After the backup has been completed, the signal analyzer application will be restarted.

For assistance, contact your nearest Keysight Technologies Sales and Service Office. To find your local Keysight office access the following URL:

<http://www.keysight.com/find/assist>



This information is subject to change without notice.

© Keysight Technologies 2018

Edition 1, March 2018

N9094-90004

www.keysight.com