

Keysight U2000 Series USB Power Sensors



Operating and
Service Guide

Notices

Copyright Notice

© Keysight Technologies 2007 - 2020
No part of this manual may be reproduced in any form or by any means (including electronic storage and retrieval or translation into a foreign language) without prior agreement and written consent from Keysight Technologies as governed by United States and international copyright laws.

Manual Part Number

U2000-90405

Edition

Edition 18, October 22, 2020

Printed in:

Printed in Malaysia

Published by:

Keysight Technologies
Bayan Lepas Free Industrial Zone,
11900 Penang, Malaysia

Technology Licenses

The hardware and/or software described in this document are furnished under a license and may be used or copied only in accordance with the terms of such license.

Declaration of Conformity

Declarations of Conformity for this product and for other Keysight products may be downloaded from the Web. Go to <http://www.keysight.com/go/conformity>. You can then search by product number to find the latest Declaration of Conformity.

U.S. Government Rights

The Software is “commercial computer software,” as defined by Federal Acquisition Regulation (“FAR”) 2.101. Pursuant to FAR 12.212 and 27.405-3 and Department of Defense FAR Supplement (“DFARS”) 227.7202, the U.S. government acquires commercial computer software under the same terms by which the software is customarily provided to the public. Accordingly, Keysight provides the Software to U.S. government customers under its standard commercial license, which is embodied in its End User License Agreement (EULA), a copy of which can be found at <http://www.keysight.com/find/sweula>. The license set forth in the EULA represents the exclusive authority by which the U.S. government may use, modify, distribute, or disclose the Software. The EULA and the license set forth therein, does not require or permit, among other things, that Keysight: (1) Furnish technical information related to commercial computer software or commercial computer software documentation that is not customarily provided to the public; or (2) Relinquish to, or otherwise provide, the government rights in excess of these rights customarily provided to the public to use, modify, reproduce, release, perform, display, or disclose commercial computer software or commercial computer software documentation. No additional government requirements beyond those set forth in the EULA shall apply, except to the extent that those terms, rights, or licenses are explicitly required from all providers of commercial computer software pursuant to the FAR and the DFARS and are set forth specifically in writing elsewhere in the EULA. Keysight shall be under no obligation to update, revise or otherwise modify the Software. With respect to any technical data as defined by FAR 2.101, pursuant to FAR 12.211 and 27.404.2 and DFARS 227.7102, the U.S. government acquires no greater than Limited Rights as defined in FAR 27.401 or DFAR 227.7103-5 (c), as applicable in any technical data.

Warranty

THE MATERIAL CONTAINED IN THIS DOCUMENT IS PROVIDED “AS IS,” AND IS SUBJECT TO BEING CHANGED, WITHOUT NOTICE, IN FUTURE EDITIONS. FURTHER, TO THE MAXIMUM EXTENT PERMITTED BY APPLICABLE LAW, KEYSIGHT DISCLAIMS ALL WARRANTIES, EITHER EXPRESS OR IMPLIED, WITH REGARD TO THIS MANUAL AND ANY INFORMATION CONTAINED HEREIN, INCLUDING BUT NOT LIMITED TO THE IMPLIED WARRANTIES OF MERCHANTABILITY AND FITNESS FOR A PARTICULAR PURPOSE. KEYSIGHT SHALL NOT BE LIABLE FOR ERRORS OR FOR INCIDENTAL OR CONSEQUENTIAL DAMAGES IN CONNECTION WITH THE FURNISHING, USE, OR PERFORMANCE OF THIS DOCUMENT OR OF ANY INFORMATION CONTAINED HEREIN. SHOULD KEYSIGHT AND THE USER HAVE A SEPARATE WRITTEN AGREEMENT WITH WARRANTY TERMS COVERING THE MATERIAL IN THIS DOCUMENT THAT CONFLICT WITH THESE TERMS, THE WARRANTY TERMS IN THE SEPARATE AGREEMENT SHALL CONTROL.

Safety Information

CAUTION

A CAUTION notice denotes a hazard. It calls attention to an operating procedure, practice, or the like that, if not correctly performed or adhered to, could result in damage to the product or loss of important data. Do not proceed beyond a CAUTION notice until the indicated conditions are fully understood and met.

WARNING

A WARNING notice denotes a hazard. It calls attention to an operating procedure, practice, or the like that, if not correctly performed or adhered to, could result in personal injury or death. Do not proceed beyond a WARNING notice until the indicated conditions are fully understood and met.

Certification

Keysight Technologies certifies that this product met its published specifications at the time of shipment from the factory. Keysight Technologies further certifies that its calibration measurements are traceable to the United States National Institute of Standard and Technology, to the extent allowed by the Institute's calibration facility, and to the calibration facilities of other International Standard Organization members.

Limitation of Warranty

















The foregoing warranty shall not apply to defects resulting from improper or inadequate maintenance by Buyer, Buyer-supplied software or interfacing, unauthorized modification or misuse, operation outside of the environmental specifications for the product, or improper site preparation or maintenance. NO OTHER WARRANTY IS EXPRESSED OR IMPLIED. KEYSIGHT TECHNOLOGIES SPECIFICALLY DISCLAIMS THE IMPLIED WARRANTIES OF MERCHANTABILITY AND FITNESS FOR A PARTICULAR PURPOSE.

Exclusive Remedies

THE REMEDIES PROVIDED HEREIN ARE BUYER'S SOLE AND EXCLUSIVE REMEDIES. KEYSIGHT TECHNOLOGIES SHALL NOT BE LIABLE FOR ANY DIRECT, INDIRECT, SPECIAL, INCIDENTAL, OR CONSEQUENTIAL DAMAGES, WHETHER BASED ON CONTRACT, TORT, OR ANY OTHER LEGAL THEORY.

Safety Symbols

The following symbols on the instrument and in the documentation indicate precautions which must be taken to maintain safe operation of the instrument.

	Direct current (DC)		Alternating current (AC)
	Off (mains supply)		On (mains supply)
	Caution, risk of electric shock		Caution, risk of danger (refer to this manual for specific Warning or Caution information)
	Earth (ground) terminal		Frame or chassis (ground) terminal
	Protective earth (ground) terminal		Equipment protected throughout by double insulation or reinforced insulation
	Both direct and alternating current		Out position of a bi-stable push control
	Caution, hot surface		In position of a bi-stable push control
	Three-phase alternating current		Equipotentiality

Safety Considerations

Read the information below before using this instrument.

The following general safety precautions must be observed during all phases of operation, service, and repair of this instrument. Failure to comply with these precautions or with specific warnings elsewhere in this manual violates safety standards for design, manufacture, and intended use of the instrument. Keysight Technologies assumes no liability for the customer's failure to comply with these requirements.

WARNING

BEFORE CONNECTING THE POWER SENSOR TO OTHER INSTRUMENTS ensure that all instruments are connected to the protective (earth) ground. Any interruption of the protective earth grounding will cause a potential shock hazard that could result in personal injury.

CAUTION

- Use the device with the cables provided.
 - Repair or service that is not covered in this manual should only be performed by qualified personnel.
-

Environmental Conditions

The U2000 Series USB power sensors are designed for indoor use and in an area with low condensation. The table below shows the general environmental requirements for this instrument.





Environmental condition	Requirement
Temperature	Operating condition – 0 °C to 55 °C
	Storage condition – -30 °C to +70 °C
Humidity	Operating condition – Up to 95% RH at 40 °C (non-condensing)
	Storage condition – Up to 90% RH at 65 °C (non-condensing)
Altitude	Operating condition – Up to 4.600 meters (15,000 feet)
	Storage condition – Up to 4.600 meters (15,000 feet)
Pollution	Degree 2

Regulatory Information

The U2000 Series USB power sensors comply with the following safety and Electromagnetic Compatibility (EMC) compliances:

- IEC 61010-1:2001 / EN 61010-1:2001 (2nd edition)
- IEC 61326:2002 / EN61326:1997+A1:1998+A2:2001+A3:2003
- Canada: ICES-001:2004
- Australia/New Zealand: AS/NZS CISPR11:2004

Regulatory Markings

 <p>ESD Sensitive</p>	<p>This symbol indicates that a device, or part of a device, may be susceptible to electrostatic discharges (ESD) which can result in damage to the product. Observe ESD precautions given on the product, or its user documentation, when handling equipment bearing this mark.</p>	<p>ICES/NMB-001</p> <p>ICES/NMB-001 indicates that this ISM device complies with the Canadian ICES-001. Cet appareil ISM est conforme a la norme NMB-001 du Canada.</p>
	<p>The RCM mark is a registered trademark of the Australian Communications and Media Authority.</p>	 <p>This instrument complies with the WEEE Directive (2002/96/EC) marking requirement. This affixed product label indicates that you must not discard this electrical or electronic product in domestic household waste.</p>
	<p>The CE mark is a registered trademark of the European Community. This CE mark shows that the product complies with all the relevant European Legal Directives.</p>	<p style="background-color: #cccccc;"> </p>

Waste Electrical and Electronic Equipment (WEEE) Directive

This instrument complies with the WEEE Directive marking requirement. This affixed product label indicates that you must not discard this electrical or electronic product in domestic household waste.

Product category

With reference to the equipment types in the WEEE directive Annex 1, this instrument is classified as a “Monitoring and Control Instrument” product.

The affixed product label is as shown below.



Do not dispose in domestic household waste.

To return this unwanted instrument, contact your nearest Keysight Service Center, or visit <http://about.keysight.com/en/companyinfo/environment/takeback.shtml> for more information.

Sales and Technical Support

To contact Keysight for sales and technical support, refer to the support links on the following Keysight websites:

- www.keysight.com/find/usbsensor
(product-specific information and support, software and documentation updates)
- www.keysight.com/find/assist
(worldwide contact information for repair and service)

THIS PAGE HAS BEEN INTENTIONALLY LEFT BLANK.

Table of Contents

Certification	3
Limitation of Warranty	3
Exclusive Remedies	3
Safety Symbols	4
Safety Considerations	5
Environmental Conditions	6
Regulatory Information	7
Regulatory Markings	8
Waste Electrical and Electronic Equipment (WEEE) Directive	9
Product category	9
Sales and Technical Support	9
1 Getting Started	
Introduction	20
Power Sensor Overview	21
LED indicator guide	22
Principles of Operation	24
The U2000 Series USB Power Sensors in Detail	27
Initial Inspection	29
Package contents checklist	29
Hardware Installation and Configuration	30
System requirements	30
Connect the power sensor	30
Using the U2000 Series with the Keysight BenchVue	33
Checking the Power Sensor Firmware	35
Keysight IO Libraries Suite 17	35
Keysight BenchVue Power Meter application	36
2 Operating Information	

Measurement Mode	38
Average only mode	38
Normal mode	38
Power Sensor Configuration Settings	41
Measurement Accuracy and Speed	43
Setting the range	43
Measurement considerations	44
Internal and External Zeroing	46
Power Sweep and Frequency Sweep	48
Step Detection	49
Pulse Power Measurement in Average only Mode	50
3 Performance Verification and Adjustments	
Introduction	52
Equipment List	53
Voltage Standing Wave Ratio (VSWR) Performance Verification	55
Equipment	55
Procedure to perform VSWR verification	55
Zero Set Performance Verification	56
Procedure	56
Sensor Accuracy Performance Verification	59
Equipment	59
Procedure to perform test system calibration	60
Procedure to perform DUT power accuracy measurement	64
Adjustments	67
4 Specifications and Characteristics	
5 Service	
General Information	72
Cleaning	72
Connector cleaning	72
Replaceable Parts	73

Service	75
Troubleshooting	75
Repairing a defective sensor	75
Disassembly and reassembly procedure	76
Attenuator disassembly and reassembly procedure for U2000B and U2001B	77
A Zero Set, Zero Drift, and Measurement Noise	
Zero Set, Zero Drift, and Measurement Noise	82

THIS PAGE HAS BEEN INTENTIONALLY LEFT BLANK.

List of Figures

Figure 1-1	Keysight U2000 Series USB power sensor family	20
Figure 1-2	LED indicator sequence during power-up	23
Figure 1-3	Block diagram of the RF/microwave USB power sensor 26	
Figure 1-4	. Simplified block diagram of diode pair/attenuator/diode pair	27
Figure 1-5	Connect the power sensor to the PC	30
Figure 1-6	Auto-locate a USB instrument in Keysight Connection Expert	31
Figure 1-7	Keysight Interactive IO dialog box	31
Figure 1-8	Identification of your connected power sensor displayed 32	
Figure 1-9	Launch the Keysight BenchVue	33
Figure 1-10	Access the Keysight BenchVue help documentation . . .	34
Figure 1-11	Keysight IO Libraries Suite	35
Figure 1-12	BenchVue Power Meter Instrument Setup panel	36
Figure 2-1	Example of trace graph display for GSM signal	39
Figure 2-2	Measurement gate	40
Figure 2-3	Auto-averaging settings	42
Figure 2-4	Select either INT or EXT from the Zero Type option . .	47
Figure 3-1	Equipment setup for zero set verification for U2000 Series models except U2000B and U2001B	56
Figure 3-2	Equipment setup for zero set verification for U2000B and U2001B	57
Figure 3-3	Power meter calibration	60
Figure 3-4	Sensor accuracy test setup calibration for U200xA . .	60
Figure 3-5	Sensor accuracy test setup calibration for U200xB . .	61
Figure 3-6	Sensor accuracy test setup calibration for U200xH . .	62
Figure 3-7	Sensor accuracy measurement setup for U200xA . . .	64
Figure 3-8	Sensor accuracy measurement setup for U200xB . . .	65
Figure 3-9	Sensor accuracy measurement setup for U200xH . . .	65

THIS PAGE HAS BEEN INTENTIONALLY LEFT BLANK.

List of Tables

Table 1-1	States of LED indicator and its description	22
Table 2-1	Sensor ranges	43
Table 2-2	Range crossover values	44
Table 3-1	Equipment list for performance verification	53
Table 5-1	Replaceable parts	73
Table 5-2	Disassembly procedure	76
Table 5-3	Attenuator disassembly procedure	78
Table 5-4	Attenuator reassembly procedure	79
Table A-1	Zero set, zero drift, and measurement noise for Average only mode	82

THIS PAGE HAS BEEN INTENTIONALLY LEFT BLANK.

1 Getting Started

Introduction	20
Power Sensor Overview	21
Principles of Operation	24
The U2000 Series USB Power Sensors in Detail	27
Initial Inspection	29
Hardware Installation and Configuration	30
Checking the Power Sensor Firmware	35

This chapter introduces the Keysight U2000 Series USB power sensor with detailed information on the principles of operation, initial inspection, hardware installation and configuration, and a brief introduction of the Keysight BenchVue Power Meter application.

Introduction

The Keysight U2000 Series USB power sensors are standalone power sensors used for measuring the average power of continuous wave (CW) and modulated signals in 9 GHz to 24 GHz frequency range and -60 dBm to $+44$ dBm power range. The power sensors provide an easy plug-and-play USB connectivity to a PC or laptop, thus eliminating the need for a separate conventional power meter. The power sensors also compatible with some selected USB-based instruments from Keysight.

The figure below shows the Keysight U2000 Series USB power sensor family.



Figure 1-1 Keysight U2000 Series USB power sensor family

Power Sensor Overview

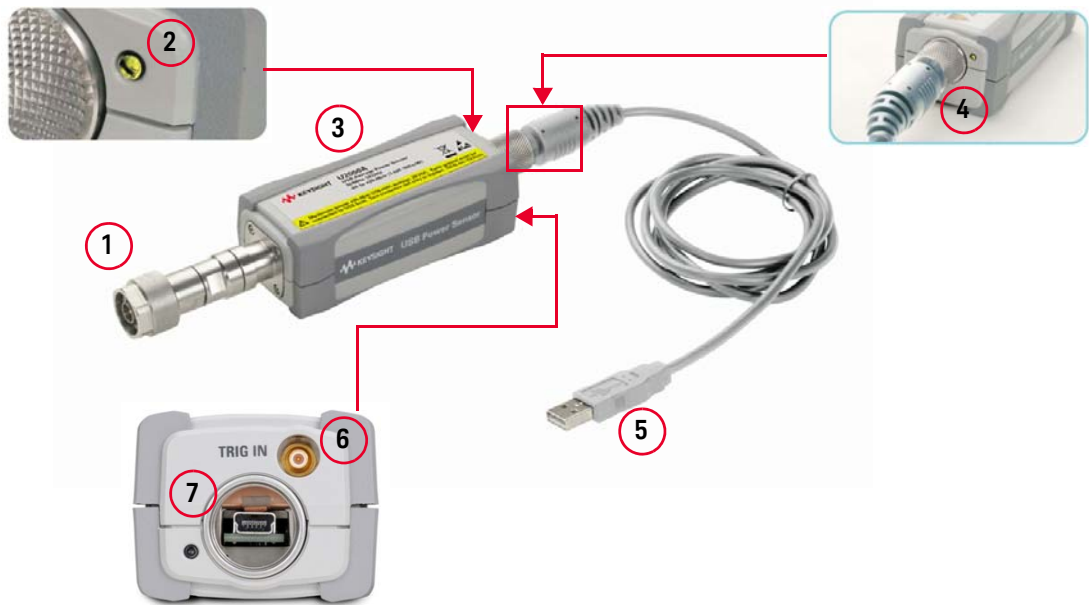

No.	Part	Functions
1	RF input port	Allows RF/microwave input signal
2	LED indicator	Indicates the states of the power sensor. Refer to “ LED indicator guide ” on page 22 for more information.
3	Sensor body	Contains the core components of the power sensor
4	Physical lock mechanism	Enables secure locking mechanism
5	USB compliant cable	Connects the power sensor to the PC or other instruments
6	External trigger port	Enables synchronization with external instruments or events
7	USB port	Enables USB connectivity

CAUTION

DO NOT remove or disassemble the gold connector on the U2002H. This is a fixed body part of the U2002H. Removing this connector will make the sensor defective.

LED indicator guide

The LED indicator is found at the rear panel of the power sensor. The following table shows the states of the LED indicator and its description.

Table 1-1 States of LED indicator and its description

LED indicator	Description
GREEN blinking	Device in communication mode. Example: Sending SCPI commands or reading data.
RED blinking	Error - Highest priority event The error is due to HW/OS/Self-test. All other LED indicators will not function while having this error. The error message can be read by sending SYST:ERR? command. Users are advised to return the power sensor to Keysight.
RED	Error. Use SYST:ERR? to read the error message. Reading the error message will also clear the LED indication. Users are advised to read the message as some of the error might cause measurement errors. Example of error cause: <ul style="list-style-type: none"> - SCPI command syntax error - Invalid Zero
AMBER	Zeroing is in progress. Sending SCPI commands during the zeroing process will cause error. This will cause the LED indicator to turn RED.

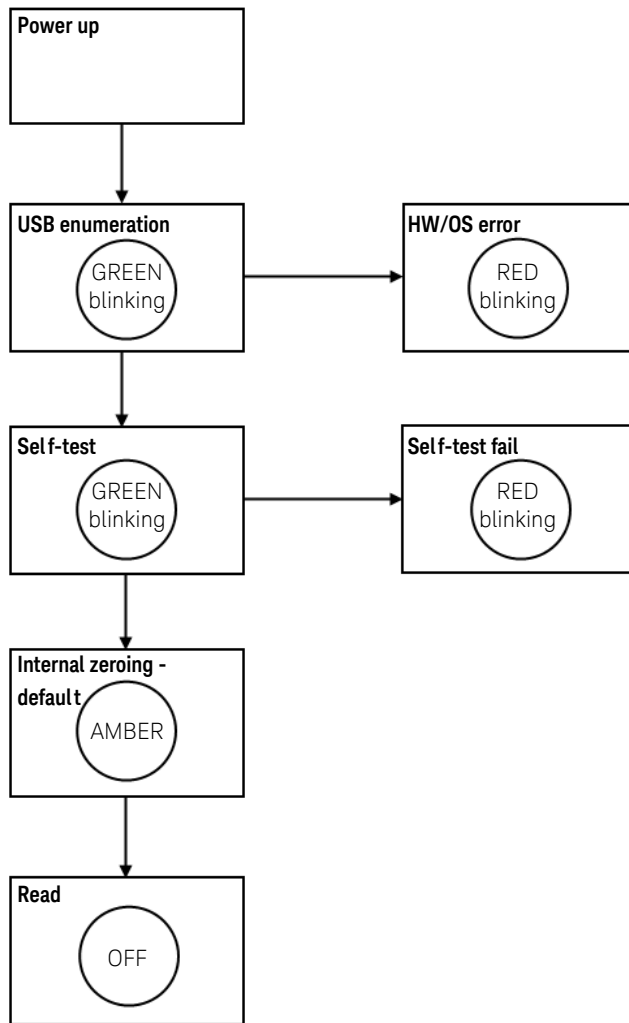

Figure 1-2 LED indicator sequence during power-up

Principles of Operation

The U2000 Series USB power sensor functions as a power meter and power sensor in one device. The power sensor has the capability of sensing the signal, acquiring the data and signal conditioning, processing the data, and fulfilling communication functions as in other Keysight test instruments.

The low power measurement path is a 2-diode stack and the high power path contains 5-diode stacks which extend the dynamic range square-law detection. The range selection is performed automatically by the U2000 Series based on the measured power levels. The sensing element technology has been previously used in the popular E9300 Series power sensors. The new U2000 Series includes all the signal conditioning and analog-to-digital formatting functions that have been in use for several years. Thus, you can be assured that the U2000 Series USB power sensor will deliver highly predictable results.^[1]

The main component for the sensing element of the U2000 Series is the RF input port assembly which provides a 50 Ω load to the RF signal applied to the power sensor. A dual range GaAs diode pair/attenuator/diode pair assembly in the RF input port rectifies the applied RF signal to produce dc voltages (high and low ranges) which vary with the RF power across the 50 Ω load. Thus, the voltage varies with the RF power dissipated in the load.

The low-level dc voltage from the RF input port assembly is picked up by the signal conditioning part of the sensor which consists of high isolation switches, chopper circuitry, and high gain amplifier. Differential electronics is maintained from the sensing element up to the 14-bit Analog-to-Digital Converter (ADC) for signal integrity and noise immunity. Amplification and signal conditioning assure that drift and gain stability are not compromised before hitting the high performance 14-bit ADC modules. From there, the digitized power data enters the processor which operates as an on-board computer for the self-contained sensor.

Sensor control and processing is provided by an embedded processor with Digital Signal Processing (DSP) capability which is supported by a 64 MB SDRAM. The available processing power enables the implementation of correction algorithms such as linearity correction, calibration factor, temperature compensation algorithm, and internal zeroing algorithm. The correction factors for the sensors

[1] Keysight Fundamentals of RF and Microwave Power Measurements (Part 2), Power Sensors and Instrumentation, Literature Number 5988-9214EN

Anderson, Alan B., October, 2000, Measuring Power Levels in Modern Communication Systems, MW/RF Magazine

are stored in a 3 MB Flash memory. In the temperature compensation algorithm and internal zeroing algorithm implementation, the processor continuously monitors sensor temperatures using a thermistor which is located in the vicinity of the diode sensing element as shown in [Figure 1-4](#). The trigger input port which is based on TTL enables the sensor to synchronize with events. The U2000 Series supports high data rate transfer of 480 Mb/s through the Universal Serial Bus (USB) connectivity which is USB-TMC compliance.

External zeroing is performed similar to other power sensors – the RF power is removed from the sensor by the user and then the sensor is zeroed. Internal zeroing is a new type of zeroing whereby the RF power can be left connected to the sensor while it is being zeroed. The power sensor will remove the RF power from the diode sensor internally in the sensor.

During the external zeroing process, the data from the front end circuitry which includes the RF diode sensing element, signal conditioning, and data acquisition circuit will be acquired. The zero information is then used. Do not apply any RF/microwave signals to the bulkhead during external zeroing process. Any RF/microwave signals pick-up by the diode sensor during the external zeroing will be considered as part of the noise.

During internal zeroing process, high isolation switches are opened in the sensor to isolate the diode sensor from the electronic circuitry. With the available processing power from the embedded DSP in the power sensor, the internal zeroing algorithm is applied to the internal zero data. The internal zeroing process simplifies the product operation by removing the circuitry noise without requiring the RF signal to be removed from the power sensor. Hence, internal zeroing is able to provide the convenience of performing a zero with the RF/microwave signal present.

RF/ μ W USB Power Sensor Block Diagram

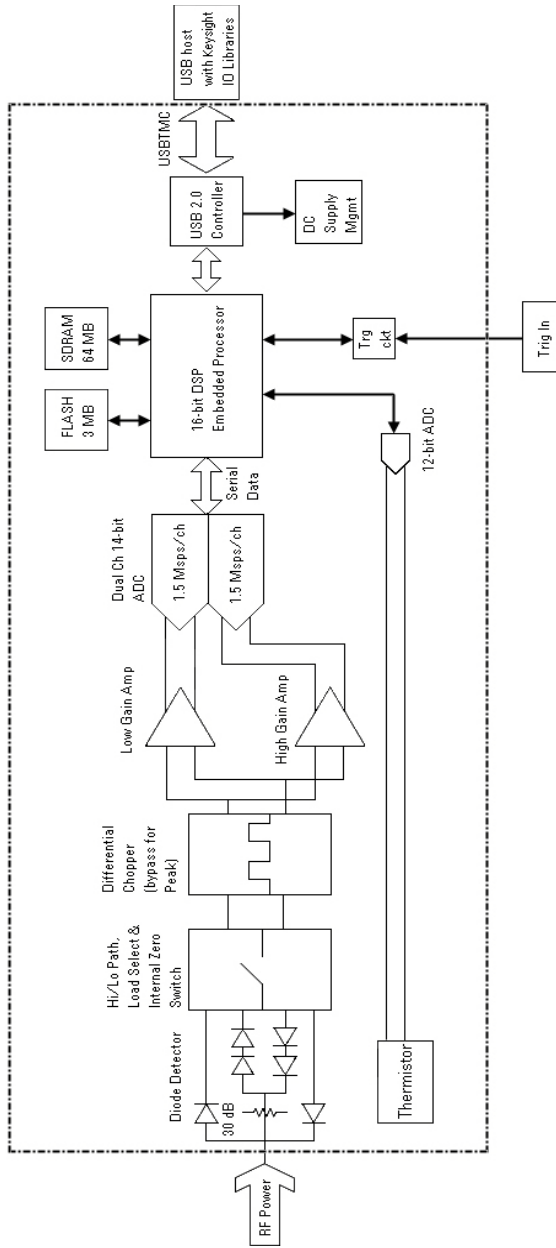

Figure 1-3 Block diagram of the RF/microwave USB power sensor

The U2000 Series USB Power Sensors in Detail

Most of the power sensors used for measuring average power employ either thermocouple or diode technology. Diode-based sensors frequently rely on the application of correction factors to extend their dynamic range beyond their square law response region, typically from -70 dBm to -20 dBm. While this technique achieves a wide dynamic range capability, however, it is limited to continuous wave (CW) signals outside the square law region. Modulated signals must be padded down or at low levels, with their average and peak power levels within the diode square law region, to be measured accurately. Accurate average power measurement of high-level signals carrying modulation cannot be obtained using a CW correction factor technique. Specialized modulation sensors are able to provide accurate measurements but are limited by the bandwidth.

The U2000 Series USB power sensor are true average, wide dynamic range RF/microwave power sensors. They are based on a dual sensor diode pair/attenuator/diode pair as proposed by Szente et. al. in 1990^[1]. Figure 1-4 shows a block diagram of this technique.

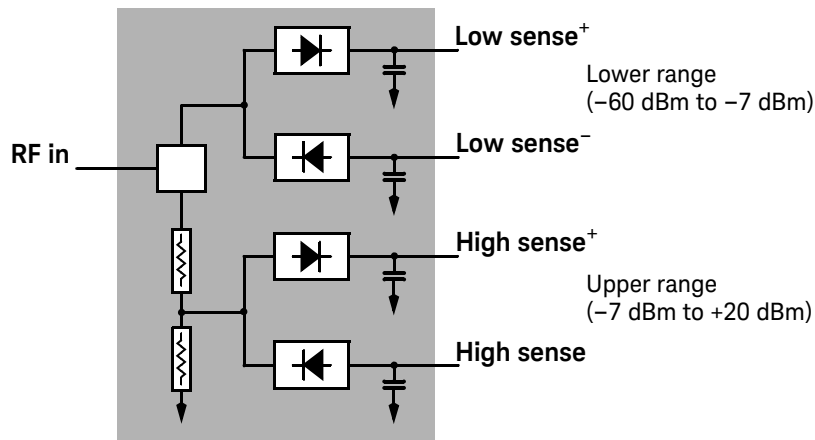

Figure 1-4 Simplified block diagram of diode pair/attenuator/diode pair

[1] US Patent #4943764, assigned to Hewlett-Packard Company

This technique will ensure the diodes in the selected signal path are kept in their square law region, thus the output current (and voltage) is proportional to the input power. The diode pair/attenuator/diode pair assembly can yield the average of complex modulation formats across a wide dynamic range, irrespective of the signal bandwidth. The dual range Modified Barrier Integrated Diode (MBID)^[1] package includes further refinements to improve power handling allowing accurate measurement of high level signals with high crest factors without incurring damage^[2] to the sensor.

These sensors measure average RF power on a wide variety of modulated signals and are independent of the modulation bandwidth. They are ideally suited to the average power measurement of multi-tone and spread spectrum signals such as CDMA, W-CDMA, and digital television formats.

[1] November 1986 Hewlett-Packard Journal pages 14-2, "Diode Integrated Circuits for Millimeter-Wave Applications.

[2] Refer to [Chapter 4, "Specifications and Characteristics"](#) for maximum power handling specifications.

Initial Inspection

Inspect the shipping container for damages. If the shipping container or packaging material is damaged, it should be kept until the contents of the shipment have been checked mechanically and electrically. If there is any mechanical damage, notify the nearest Keysight Technologies office. Keep the damaged shipping materials (if any) for inspection by the carrier and a Keysight Technologies representative.

Package contents checklist

Inspect and verify the following items for the standard purchase of the U2000 Series USB power sensor. If there are missing items, contact the nearest Keysight Sales Office.

- Trigger cable BNC Male to SMB female 50 Ω , 1.5 m
- Power sensor cable, 1.5 m
- Certificate of Calibration
- U2000 Series USB Power Sensors Documentation CD
- Keysight Automation-Ready CD (contains Keysight IO Libraries Suite)

Hardware Installation and Configuration

System requirements

Prior to using the U2000 Series USB power sensor, please ensure that the following minimum requirements are met:

- PC or any device that has USB host capability
- Keysight IO Libraries Suite 15.5 or higher had been installed. Users are encouraged to obtain the latest version of Keysight Libraries Suite for better performance.
- *Optional:* Keysight BenchVue Power Meter application is installed.
- The U2000 Series can also be programmed using remote programming software such as Keysight VEE, LabVIEW, and Microsoft Visual Basics

Connect the power sensor

- 1** Connect the power sensor to the PC. The sensor driver is detected and installed automatically.

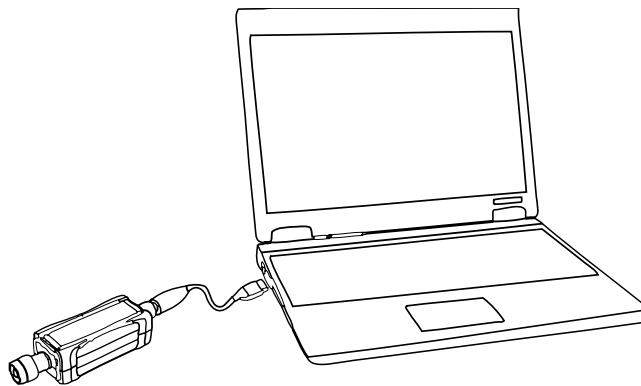



Figure 1-5 Connect the power sensor to the PC

- 2 Launch the Keysight Connection Expert by selecting the IO icon (). Auto-locate the sensor as shown in [Figure 1-6](#). Click **Rescan** to start searching.

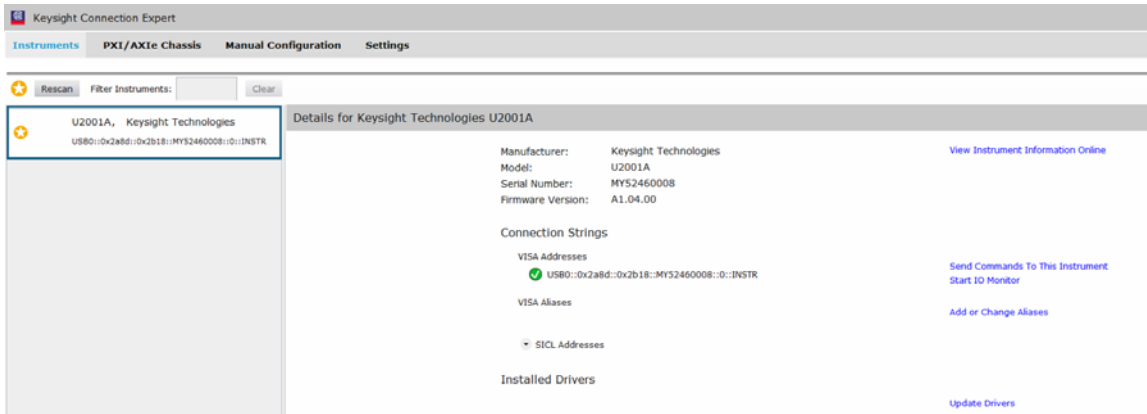

Figure 1-6 Auto-locate a USB instrument in Keysight Connection Expert

- 3 Select **Send Command To This Instrument** and the Keysight Interactive IO dialog box will appear as shown below.

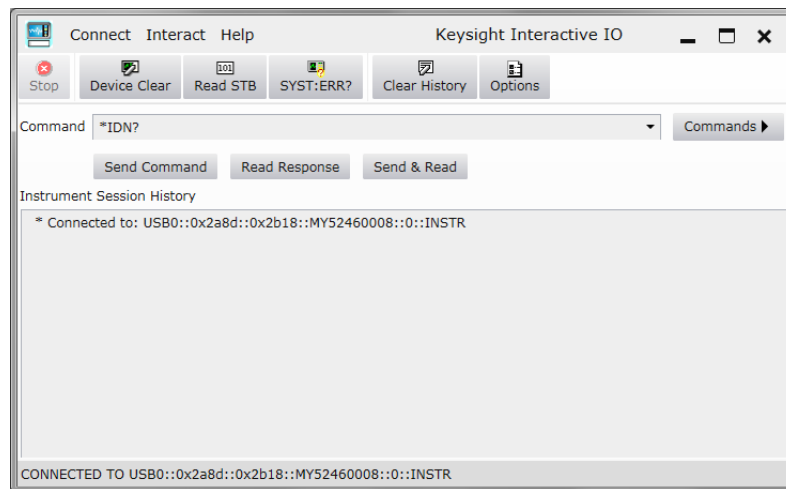

Figure 1-7 Keysight Interactive IO dialog box

- 4 To verify your connected power sensor, send the default SCPI command ***IDN?** to the power sensor by clicking **Send & Read**. The device's response will appear in the **Instrument Session History** panel as shown in the following figure.

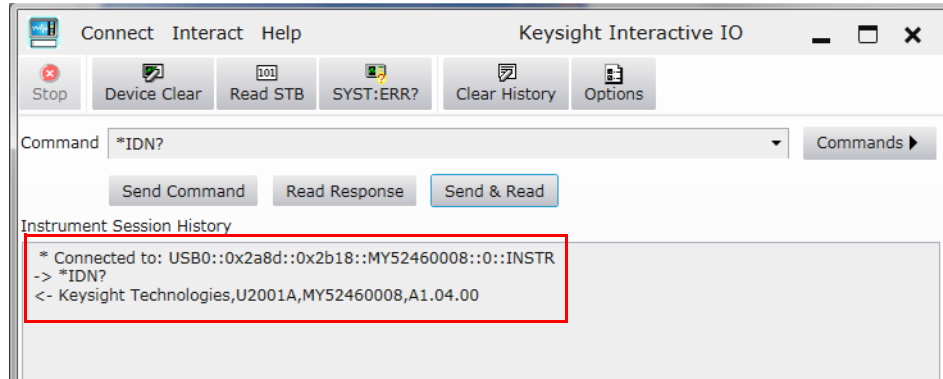

Figure 1-8 Identification of your connected power sensor displayed

- 5 This verify that your U2000 Series USB power sensor has been connected and properly installed on your PC.
- 6 When the sensor is connected, refer to [“Using the U2000 Series with the Keysight BenchVue”](#) on page 33 to launch the BenchVue Power Meter application, or proceed to operate the sensor via remote programming.

Operating the sensor remotely using SCPI commands

You can send SCPI commands to operate the sensor. Refer to the *Keysight U2000 Series USB Power Sensors Programming Guide* for details.

Using the U2000 Series with the Keysight BenchVue

The BenchVue Power Meter application provides a virtual operating interface for the U2000 Series.

NOTE

For more information on how to configure each U2000 Series function or use each BenchVue Power Meter feature, refer to the Keysight BenchVue Power Meter help documentation.

Go to **Start > All Programs > Keysight > Keysight BenchVue > Keysight BenchVue** to launch the BenchVue Power Meter application.

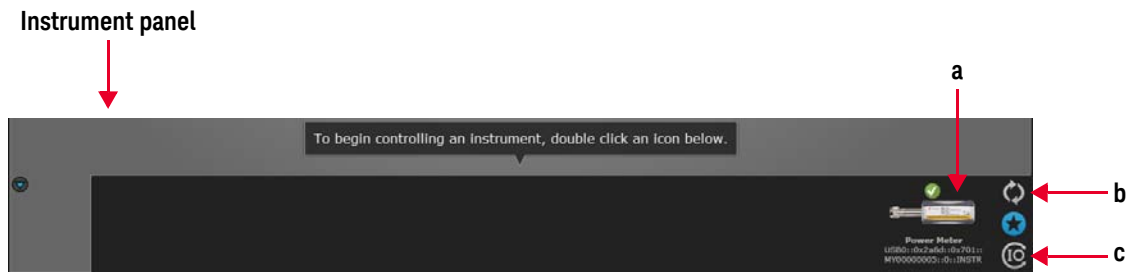





Figure 1-9 Launch the Keysight BenchVue

- a** Double-click the connected sensor () at the Instrument panel to start controlling the power sensor.
- b** If the sensor is found in the Keysight Connection Expert but is not shown in the BenchVue Instrument panel, select the refresh icon () to refresh the instrument list.
- c** If the sensor is not found, select the IO icon () to launch the Keysight Connection Expert to verify that the power sensor is connected properly.

When you launch the BenchVue Power Meter application, the Digital Meter is displayed by default.

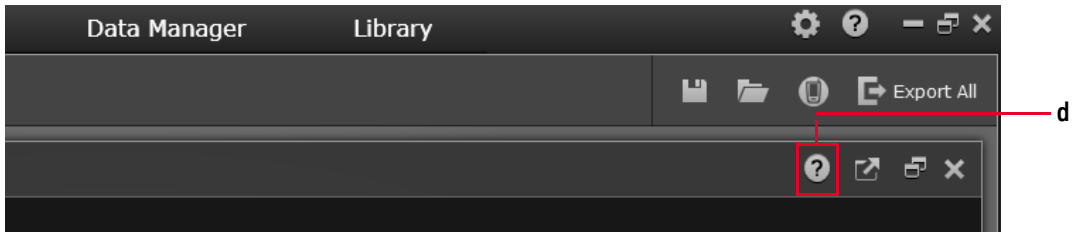

Figure 1-10 Access the Keysight BenchVue help documentation

- d** Click (?) to access the BenchVue Power Meter help documentation.

Checking the Power Sensor Firmware

There are two ways that can be used to check the firmware revision of the power sensor:

Keysight IO Libraries Suite 17

By using the Keysight IO Libraries Suite version 17 or higher, you can check the manufacturer, model, serial number, firmware version, and USB address. The VISA address is the USB address (see below).

VISA Addresses

 **USB0::0x2a8d::0x2b18::MY52460008::0::INSTR**

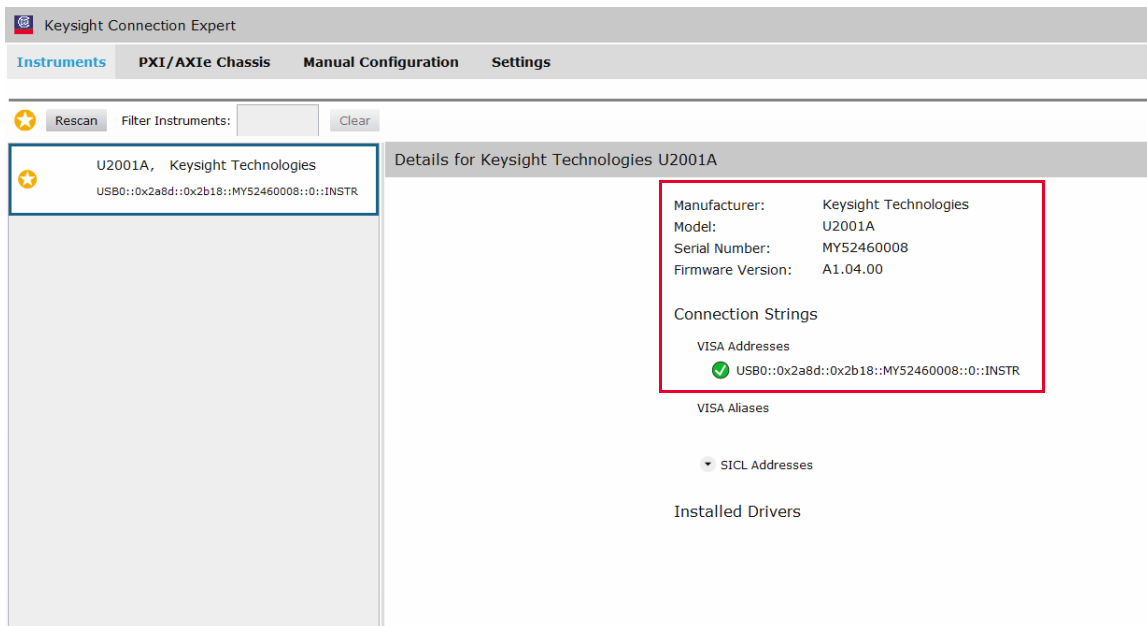

Figure 1-11 Keysight IO Libraries Suite

1 Getting Started

Keysight BenchVue Power Meter application

By using the BenchVue Power Meter application, you can check the system description consisting of the model number, serial number, firmware revision, and resource ID as shown below:

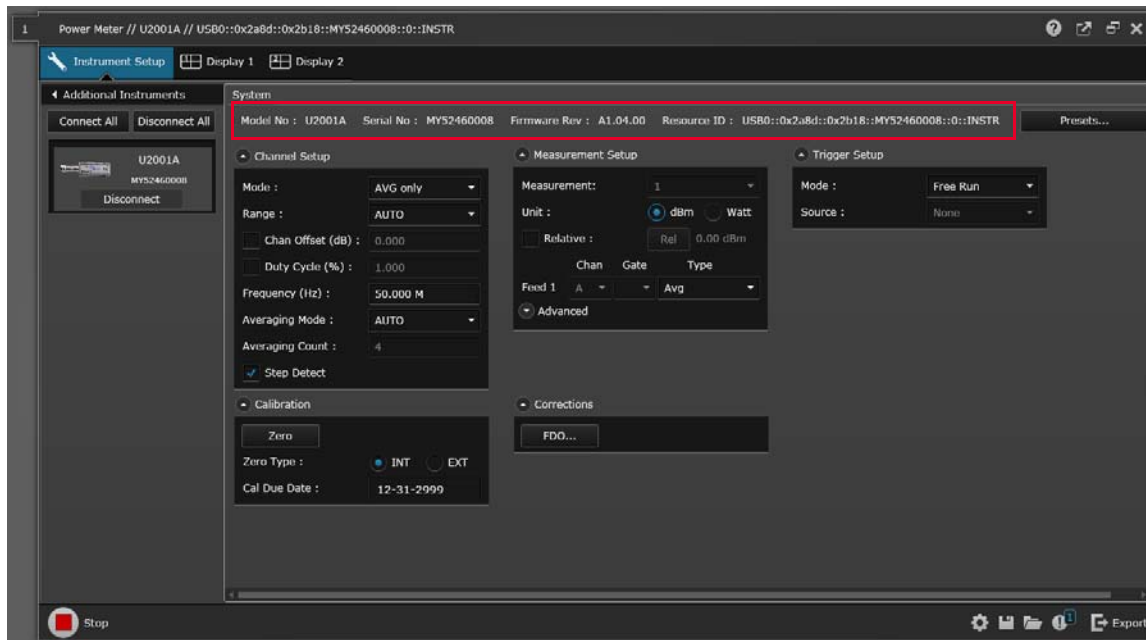

Figure 1-12 BenchVue Power Meter Instrument Setup panel

2 Operating Information

Measurement Mode	38
Power Sensor Configuration Settings	41
Measurement Accuracy and Speed	43
Internal and External Zeroing	46
Power Sweep and Frequency Sweep	48
Step Detection	49
Pulse Power Measurement in Average only Mode	50

This chapter describes some general operating information of the U2000 Series USB power sensors.

Measurement Mode

The U2000 Series USB power sensors have two measurement modes: Average only (chopper-based measurement) and Normal^[1] (sample-based measurement) mode.

Average only mode

The Average only mode (default mode) is optimized for wide dynamic range. In this measurement mode, a trigger can be controlled externally via TTL input.

Normal mode

The Normal mode is used for making average power measurement in a defined time interval (also known as time-gated measurement) with reduced dynamic range. A trigger can be derived from an RF signal (internal trigger) or controlled externally via TTL input (external trigger).

Trace display

The U2000 Series USB power sensor can also be configured to display measurement results in trace format using SCPI commands or the BenchVue Power Meter application when the power sensors are set to Normal mode.

To create the trace graph display using SCPI commands, refer to the programming example available in the *Keysight U2000 Series USB Power Sensors Programming Guide*.

To set up the trace graph display using the BenchVue Power Meter application, refer to the software help file for a step-by-step procedure.

Figure 2-1 shows the illustration of the trace graph if the BenchVue Power Meter application is used.

[1] Not applicable for U2004A.

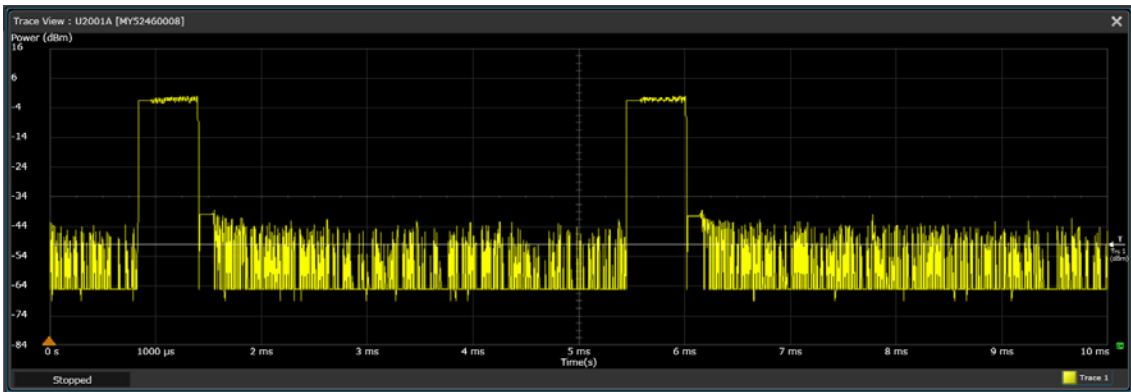

Figure 2-1 Example of trace graph display for GSM signal

Measurement gate

A gate, controlled by and referenced to a trigger point, is used to extract measurement data from the captured trace. You can measure the gated average power of pulsed signals with the gate setup as shown in [Figure 2-2](#).

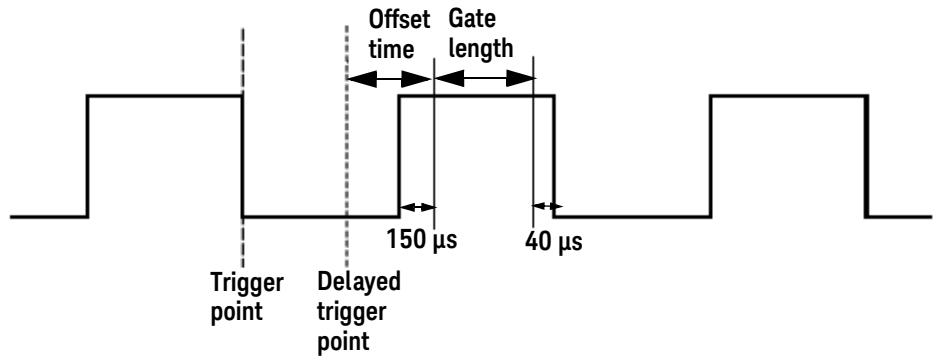

Figure 2-2 Measurement gate

NOTE

It is strongly recommended for the gate to have 150 μs (range settling time) offset from the pulse rising edge and 40 μs (fall time) offset from the pulse falling edge to achieve higher accuracy measurements. Samples collected during range settling time are discarded. Thus, fewer samples are used for generating a measurement.

Power Sensor Configuration Settings

The auto-averaging settings shown in [Figure 2-3](#) are automatically configured when the U2000 Series USB power sensors are connected.

NOTE

Averaging settings can also be manually configured.

In [Figure 2-3](#), the dotted-line arrow  indicates the internal range based on the internal circuitry of the power sensor. The ranges will be automatically selected in correspondence with the power level to best fit the operating conditions and settings.

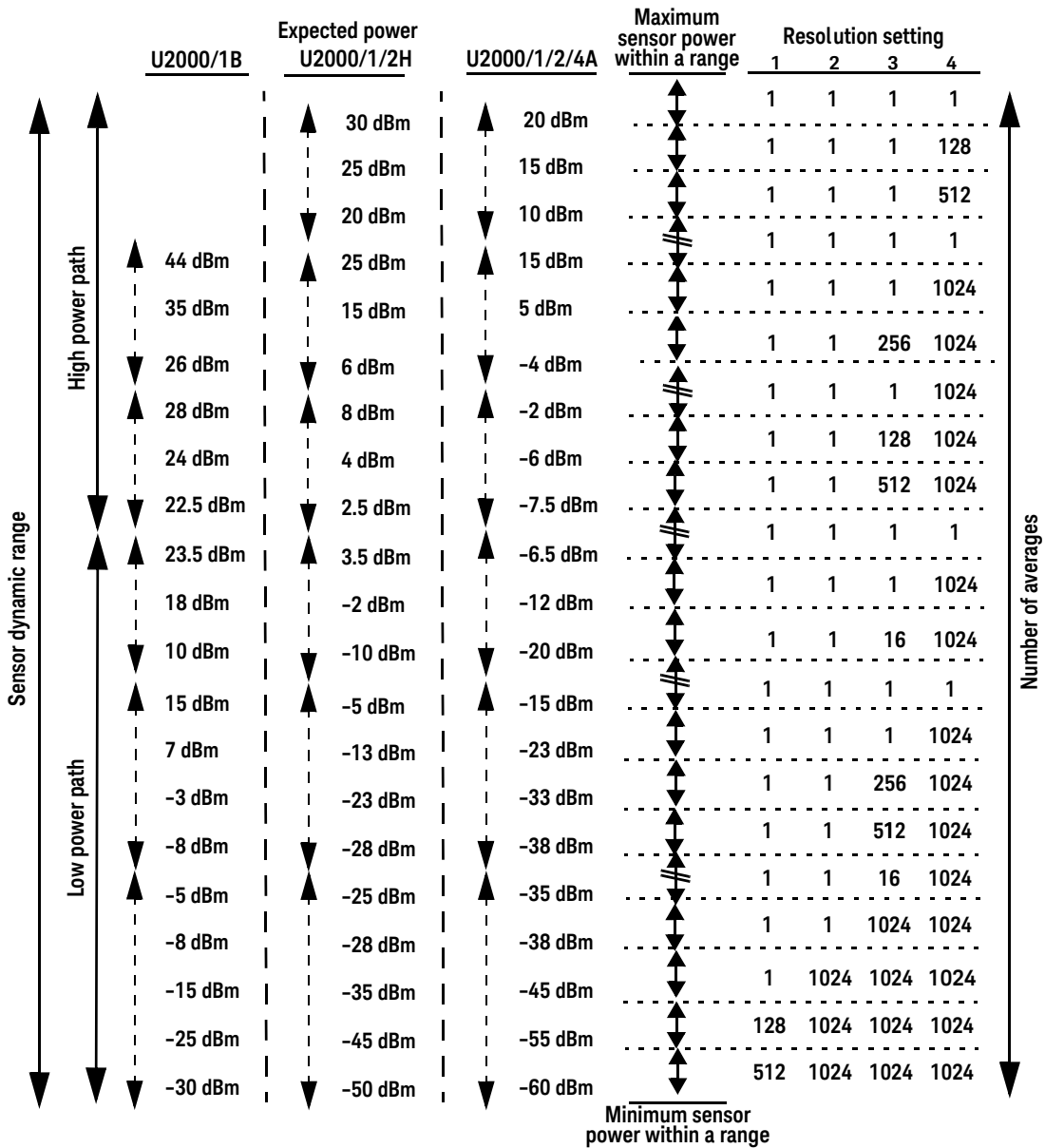

Figure 2-3 Auto-averaging settings

Measurement Accuracy and Speed

With U2000 Series USB power sensor, the range can be set either automatically or manually. Use auto-ranging when you are not sure of the power level you are about to measure.

The DC coupling of the U2004A USB power sensor input allows excellent low frequency coverage. However, the presence of any DC voltages mixed with the signal will have an adverse effect on the accuracy of the power measurement, see [Chapter 4, "Specifications and Characteristics"](#).

CAUTION

To prevent damage to your sensor, do not exceed the power levels specified in [Chapter 4, "Specifications and Characteristics"](#).

The U2004A USB power sensor is DC coupled. DC voltages in excess of the maximum value (5 VDC) can damage the sensing diode.

Setting the range

There are two manual settings, "LOWER" and "UPPER". The LOWER range uses the more sensitive path and the UPPER range uses the attenuated path in the U2000 Series USB power sensor (see [Table 2-1](#)).

Table 2-1 Sensor ranges

Sensor	LOWER range	UPPER range
U2000A, U2001A, U2002A, U2004A	-60 dBm to -7 dBm	-7 dBm to +20 dBm
U2000H, U2001H, U2002H	-50 dBm to +3 dBm	+3 dBm to +30 dBm
U2000B, U2001B	-30 dBm to +23 dBm	+23 dBm to +44 dBm

The default is “AUTO”. In AUTO the range crossover value depends on the sensor model being used (see [Table 2-2](#)).

Table 2-2 Range crossover values

Sensor	Range crossover values
U2000A, U2001A, U2002A, U2004A	-7 dBm \pm 1 dB
U2000H, U2001H, U2002H	+3 dBm \pm 1 dB
U2000B, U2001B	+23 dBm \pm 1 dB

Measurement considerations

While auto-ranging is a good starting point, it is not ideal for all measurements. Signal conditions such as crest factor or duty cycle may cause the power sensor to select a range which is not the optimum configuration for your specific measurement needs. Signals with average power levels close to the range switch point require you to consider your needs for measurement accuracy and speed.

For example, a U2000/1/4A sensor, where the range switch point is -7 ± 1 dBm in a pulsed signal, should be configured as follows:

Characteristic	Value
Peak amplitude	-6 dBm
Duty cycle	25%

The calculated average power is -12 dBm.

Accuracy

The value of -12 dBm lies in the lower range of the U2000/1/4A sensor. In auto-ranging mode (“AUTO”), the U2000/1/4A sensor determines the average power level is below -7 dBm and selects the low power path. However, the peak amplitude of -6 dBm is beyond the specified square law response range of the low power path diodes. The high power path (-7 dBm to $+20$ dBm) should be used to ensure a more accurate measurement of this signal. However, range holding in “UPPER” (the high power path), for a more accurate measurement, results in a considerably increased number of filtering processes.

Speed and averaging

The same signal also requires a specific consideration of the measurement speed. As shown above, in auto-ranging mode, the U2000/1/4A sensor determines the average power level is below -7 dBm and selects the low power path. With auto-averaging configured, minimal filtering is applied. Values of one to four for average power levels above -20 dBm are used in the low power path. (Refer to “Auto-averaging settings” on page 42.)

If the range is held in “UPPER” for more accuracy, the measurement is slower. More filtering is applied due to the increase in noise susceptibility at the less sensitive area of the high power path. Values of one to 128 for average power levels less than -7 dBm are used. (Again, refer to “Auto-averaging settings” on page 42.) Manually lowering the filter settings speeds up the measurement but can result in an unwanted level of jitter.

Summary

Attention must be paid to signals where the average power levels are in the low power path range while the peaks are in the high power path range. You can achieve best accuracy by selecting the high power path or achieve best speed by selecting the low power path.

Internal and External Zeroing

Zeroing a power sensor is performed in order to reduce zero measurement offset and noise impact to improve the accuracy of RF power measurement. The U2000 Series USB power sensor have two types of zeroing; internal zeroing and external zeroing.

Internal zeroing is a new type of zeroing process whereby RF/Microwave power can be left connected to the sensor while it is being zeroed. High isolation switches are opened in the sensor to isolate the diode sensor from the electronic circuitry. With the available processing power from the embedded DSP in the sensor, the internal zeroing algorithm is applied to the internal zeroing data. Hence, internal zeroing provides the convenience of performing a zero with the RF/microwave signal present. This feature makes internal zeroing more convenient, but one may only use internal zeroing if zero set (internal) is within the user's application requirements.

External zeroing process is a two-step process. The RF/Microwave signal to be measured must be removed from the sensor and then the sensor can be zeroed. Do not apply any RF/microwave signals to the RF input port during external zeroing process. Any RF/microwave signals pick-up by the diode sensor during external zeroing will be considered as part of the noise. External zeroing generally has better zero set performance. The internal or external zeroing selection should be made based on the measurement needs.

Users can choose to use either internal zeroing or external zeroing. The sensor is defaulted with internal zero every time it is powered up. [Figure 2-4](#) shows the illustration on how to set the external zeroing if the BenchVue Power Meter application is used.

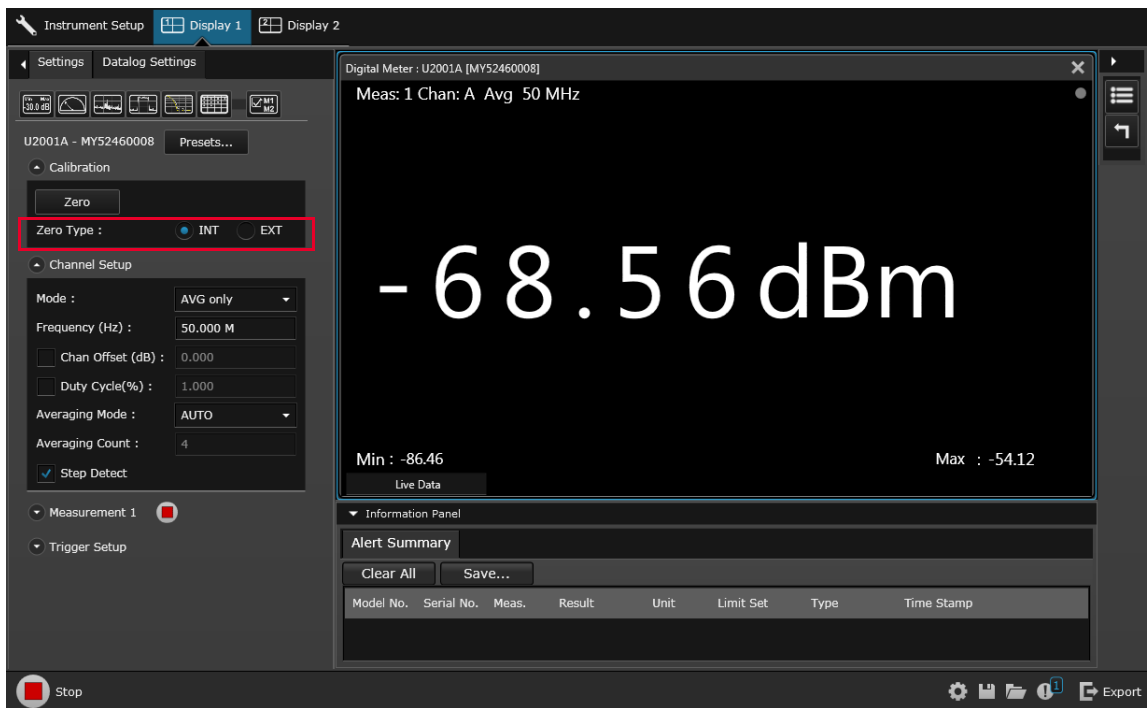

Figure 2-4 Select either INT or EXT from the Zero Type option

Power Sweep and Frequency Sweep

The frequency sweep and power sweep features provide measurement automation between the U2000 Series USB power sensor and the signal source. This feature reduces the communication path and improves test time by eliminating the need of PC-instrument communication.

To perform frequency sweep operation, users are required to set the start frequency, stop frequency and number of step for the signal source. By default, the step value is set to 0. The number of step ranges from 0 to 2048.

Connect the signal source TRIG OUT to the power sensor TRIG IN. Once the sweeping operation starts, the signal source will step through each frequency point within the preset range. Each step will send a TTL signal to the power sensor notifying it to measure the signal power. Only a one-way synchronization occurs in this process which is from the signal source to the power sensor.

A proper dwell time must be set in the signal generator to ensure all the measurement readings in the power sensor are settled before stepping through the next frequency point. The same process is applicable to the power sweep operation.

Step Detection

To reduce the filter settling time after a significant step in the measured power, the filter can be set to re-initialize upon detection of a step increase or decrease in the measured power. Step detection can be set in both manual and automatic filter modes. Refer to the *Keysight U2000 Series USB Power Sensors Programming Guide* for more details on how to enable or disable the step detection.

Pulse Power Measurement in Average only Mode

The U2000 Series USB power sensor provide capability of performing average power measurements of pulsed signals in Average only mode with the signal profile as shown below:

- Pulse width $\geq 30 \mu\text{s}$
- Pulse period $\leq 8 \text{ ms}$
- Duty cycle $\geq 1\%$

To perform accurate average power measurements of pulsed signals, preset the sensor to Burst mode or using “**SYSTem:PRESet BURST**” SCPI command. It is recommended to disable the step detection and set the average count to ≥ 256 .

The U2000 Series USB power sensor are designed to perform average power measurements over dynamic range of -60 dBm to $+44 \text{ dBm}$. The supported power range for each sensor model is shown as follows:

Model	Power range
U2000/1/2A	-60 dBm to $+20 \text{ dBm}$
U2000/1/2H	-50 dBm to $+30 \text{ dBm}$
U2000/1B	-30 dBm to $+44 \text{ dBm}$

Regular external zeroing and higher average count are required when the pulsed signal is under one of the following circumstances:

- The pulse power takes place within the last 10 dB of the sensor’s lower dynamic range (for example, -60 dBm to -50 dBm for U2000/1/2A model)
- The pulse width is from $30 \mu\text{s}$ to $40 \mu\text{s}$
- The duty cycle is $< 2\%$

NOTE

The pulse power measurement in Average only mode is not applicable for U2004A.

3 Performance Verification and Adjustments

Introduction	52
Equipment List	53
Voltage Standing Wave Ratio (VSWR) Performance Verification	55
Zero Set Performance Verification	56
Sensor Accuracy Performance Verification	59
Adjustments	67

This chapter contains the performance verification procedures which verify that the U2000 Series is operating within its published specifications.

Introduction

The performance verification procedures described in this chapter verify the U2000 Series USB power sensors performance against the specifications detailed in the datasheet. Use the performance verification procedures for incoming inspection during the calibration cycle (also called periodic maintenance), or after repairs have been made.

NOTE

- This document does not provide a complete breakdown for these verification procedures. A brief overview of each verification procedure is described in this document. Keysight N7800 Series calibration software should be used at all times when performing these verification procedures.
 - Performance verification is limited to measuring and verifying warranted specifications.
 - Measurement uncertainty will not be addressed in this document (this is handled by the N7800 Series software).
-

Equipment List

The following equipment are required for performance verification:

Table 3-1 Equipment list for performance verification

Equipment	Critical specification	Recommended Keysight model
Network analyzer	10 MHz to 24 GHz (dependent on U2000 Series sensor model) frequency range	E8361A/1C/4B/4C or N5230A/30C/45A
	9 kHz to 6 GHz (for U2004A) frequency range	E5071C
Calibration kit	Type-N calibration kits	85054D or 85032F
	3.5 mm type calibration kits	85052B
Spectrum analyzer	Operating range: 50 MHz Scale fidelity: $\pm(0.009 \text{ dB} + 0.003 \text{ dB per } 10 \text{ dB step})$ Option 1DS (RF internal preamplifier)	E4440A/3A/5A/6A/8A
Signal generator	Power range: -55 dBm to $+6 \text{ dBm}$ at 50 MHz Option 1E1 (Step Attenuator)	E8257D
Power supply for amplifier	Output range Voltage: 24 VDC Current (maximum): 0.9 A	E3632A
	Output range Voltage: 24 VDC Current (maximum): 10.5 A	N5745A
Power meter	Average power meter, compatible with 8480 Series and N8480 Series power sensors Absolute accuracy: $\pm 0.8\%$	E4418B/9B or N1913A/4A or E4416A/7A
Power sensor	Frequency: 10 MHz or above Standing wave ratio (SWR): ≤ 1.15 at 50 MHz	N8481A/N8481H/N8485A
Fixed attenuators	Attenuation: 6 dB	8491A option 006
	Attenuation: 10 dB	8491A option 010

Table 3-1 Equipment list for performance verification (continued)

Equipment	Critical specification	Recommended Keysight model
Directional RF coupler	Frequency range: 50 MHz Directivity: ≥ 20 dB to 40 dB (dependent on U2000 Series sensor model)	-
Amplifier	Maximum output power: ≥ 50 dBm	-

Voltage Standing Wave Ratio (VSWR) Performance Verification

VSWR is a measure of how efficiently RF power is transmitted from an RF power source. In real systems, mismatched impedances between the RF source and load can cause some of the power to be reflected back towards the source and vary the VSWR.

Equipment

The following lists the required equipment:

- Network analyzer (E8361A/1C/4B/4C or N5230A/30C/45A or E5071C)
- Mechanical calibration kit (85054B/52B/32F)

Procedure to perform VSWR verification

- 1** Turn on the network analyzer and allow it to warm up for approximately an hour.
- 2** Set the start and stop frequency of the network analyzer accordingly to the U2000 Series models.
- 3** Calibrate the network analyzer using the appropriate calibration kit. Perform calibration for the open, short, and load circuits of the network analyzer.
- 4** After calibration, connect the U2000 Series to the test port of the network analyzer. Turn on Correction on the network analyzer to perform the VSWR measurement.
- 5** Compare the measured results to the specifications in the data sheet. If the verification fails, refer to **“Adjustments”** on page 67.

Zero Set Performance Verification

This performance verification is carried out to verify that a minimal amount of residual offset error is present after zeroing has been performed. The offset error is caused by contamination from several sources including the noise of the device-under-test (DUT) itself. Zero set is the difference between the power levels indicated by the DUT, after executing zeroing and the true zero power. This difference should ideally be zero.

This performance verification requires a computer with the Keysight IO Libraries Suite installed.

Procedure

- 1 Connect the DUT to your PC as shown in [Figure 3-1](#) (U2000 Series models except U2000B and U2001B) or [Figure 3-2](#) (U2000B and U2001B models).

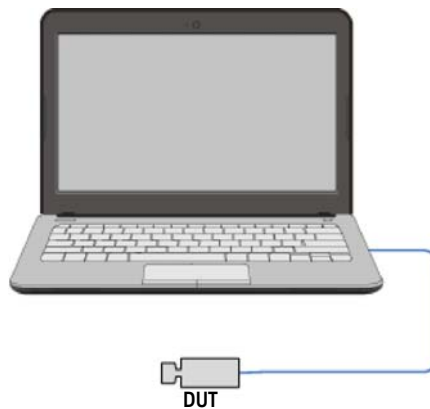

Figure 3-1 Equipment setup for zero set verification for U2000 Series models except U2000B and U2001B

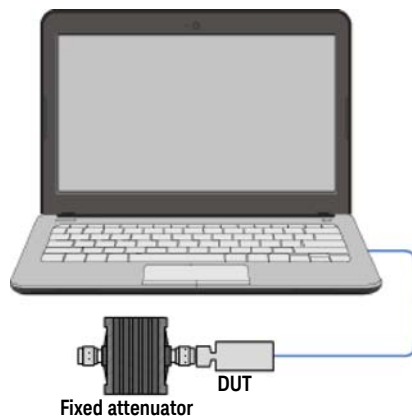

Figure 3-2 Equipment setup for zero set verification for U2000B and U2001B

- 2 Launch the Keysight IO Libraries Suite on your PC.
- 3 Warm up the DUT for approximately an hour.
- 4 Launch the **Interactive IO** on the Keysight IO Libraries Suite to send SCPI commands to the DUT.
- 5 Set the frequency of the DUT to 50 MHz by sending the SCPI command `FREQ 50 MHz`.
- 6 Perform external zeroing for the DUT for Zero Set (External) by sending the SCPI commands `CAL:ZERO:TYPE EXT` and `CAL:ZERO:AUTO ONCE`.
- 7 Enable auto-averaging for the DUT by sending the SCPI command `AVER:COUN:AUTO ON`.
- 8 Change the power measurement unit of the DUT to watt by sending the SCPI command `UNIT:POW W`.
- 9 Set the DUT to the single trigger mode by sending the SCPI command `INIT:CONT OFF`.
- 10 Read the noise level of the DUT by sending the SCPI command `READ?` and then record the reading.
- 11 Repeat **step 10** for 10 times, and then calculate the mean value of the readings.

3 Performance Verification and Adjustments

- 12** Perform internal zeroing for the DUT for Zero Set (Internal), by sending the SCPI commands `CAL:ZERO:TYPE INT` and `CAL:ZERO:AUTO ONCE`.
- 13** Repeat [step 6](#) to [step 11](#).
- 14** Compare the calculated mean value results to the specifications in the data sheet. If the verification fails, refer to [“Adjustments”](#) on page 67.

Sensor Accuracy Performance Verification

The purpose of this verification is to verify the accuracy of the U2000 Series after a period of usage to ensure that the U2000 Series is still within its published specifications.

Equipment

The following lists the required equipment:

- Spectrum analyzer (E4440A/3A/5A/6A/8A with Option 1DS)
- PSG analog signal generator (E8257D with option 520 with 1E1)
- Power supply for power amplifier (E3632A and N5745A)
- Power meter (E4419B/N1914A)
- Power sensor (N8481A/N8485A/N8481H)
- Fixed attenuator (8491A option 006 and 8491A option 010)
- Directional RF coupler
- Power amplifier
- Low-pass filter
- Adapters^[1]

[1] Optional as indicated by the dotted connection in the following figures.

Procedure to perform test system calibration

- 1 Connect the standard power sensor to the power meter Power Ref port to perform zeroing and calibrating.

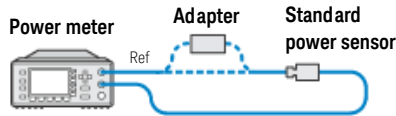

Figure 3-3 Power meter calibration

- 2 Connect the standard sensor (use an adapter if required) to the test port. Connect the equipment as shown in [Figure 3-4](#) (U200xA Series), [Figure 3-5](#) (U200xB Series), and [Figure 3-6](#) (U200xH Series).

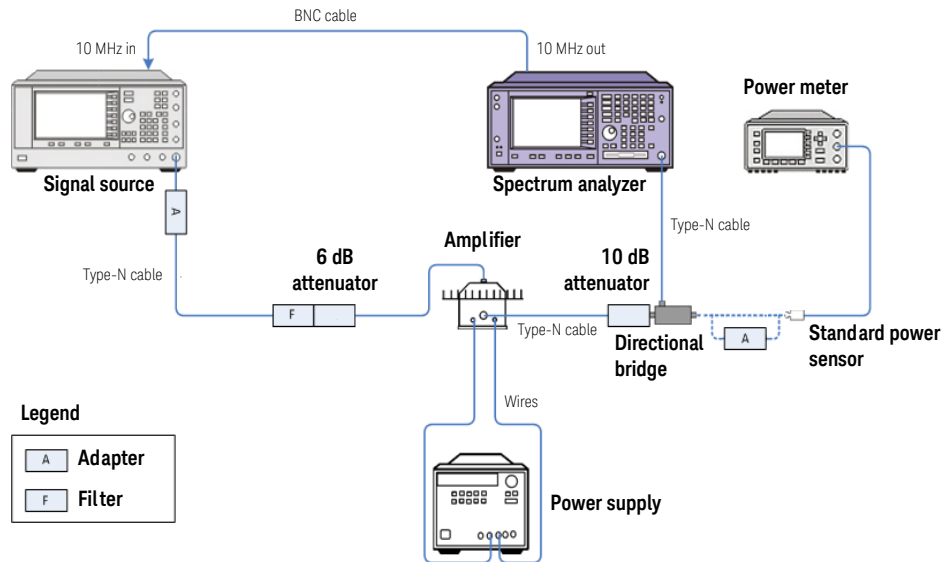

Figure 3-4 Sensor accuracy test setup calibration for U200xA

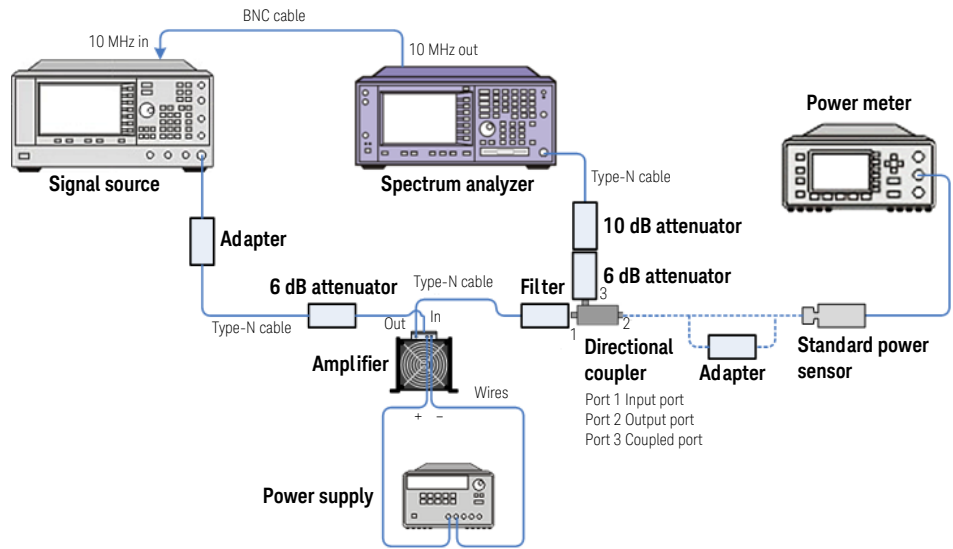

Figure 3-5 Sensor accuracy test setup calibration for U200xB

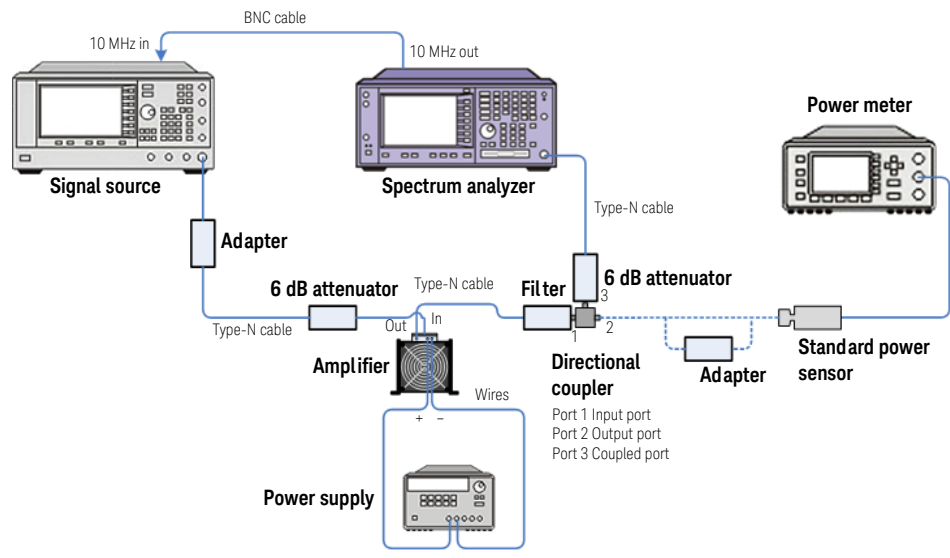

Figure 3-6 Sensor accuracy test setup calibration for U200xH

- 3** For the E3632A power supply, perform the following steps to power up the amplifier.
 - a** Turn on the power supply.
 - b** Connect the + power supply output to the amplifier +24 V.
 - c** Connect the - power supply output to the amplifier GND.
 - d** Set the power supply range to 30 V, 4 A.
 - e** Set the power supply Over Voltage Protection to 24.5 V.
 - f** Set the power supply Display Limit for voltage to 24 V and current to 0.9 A.
 - g** Turn on the power supply output, and then monitor to ensure the power supply is in constant voltage mode.
- 4** For the N5745A power supply, perform the following steps to power up the amplifier.
 - a** Turn on the power supply.
 - b** Connect the + power supply output to the amplifier +24 V.

- c** Connect the – power supply output to the amplifier GND.
 - d** Set the voltage to 24 V.
 - e** Turn on the power supply output, and then monitor to ensure the power supply is in constant voltage mode.
- 5** Set the signal generator to the test point frequency of 50 MHz.
 - 6** Set the spectrum analyzer frequency to 50.0025 MHz.
(center frequency = signal frequency + 2500 Hz, as recommended in the PSA Series Spectrum Analyzers Guide)
 - 7** Adjust the signal generator power so that the power meter reads 0 +/- 0.1 dBm.
 - 8** Take note of the power level that is set on the signal generator for this frequency, Pset. Pset will be used to aid setting the initial power level during measurements. Refer to [step 7](#) of the “[Procedure to perform DUT power accuracy measurement](#)” on page 64.
 - 9** Record the reference power meter reading for this frequency, Pref_{PM}.
 - 10** Take a reading on the spectrum analyzer by pressing **[Single]**. Record the reference spectrum analyzer reading for this power level: Pref_{SA}.
 - 11** Calculate the tracking calibration for this frequency:
$$Ptrk = Pref_{PM} - Pref_{SA}$$

Procedure to perform DUT power accuracy measurement

- 1 Perform test system calibration first before performing DUT power accuracy measurement. Refer to “[Procedure to perform test system calibration](#)” on page 60 for complete steps.
- 2 Perform DUT zeroing (External zeroing estimated at 35 seconds, Internal zeroing estimated at 15 seconds) by sending the SCPI command `CAL:ZERO:AUTO ONCE`.
- 3 Turn off the power supply output.
- 4 Disconnect the standard power sensor from test port and connect the standard power sensor with the DUT. Connect the equipment as shown in [Figure 3-7](#) (U200xA Series), [Figure 3-8](#) (U200xB Series), and [Figure 3-9](#) (U200xH Series) depending on sensor models before turning on the power supply output.

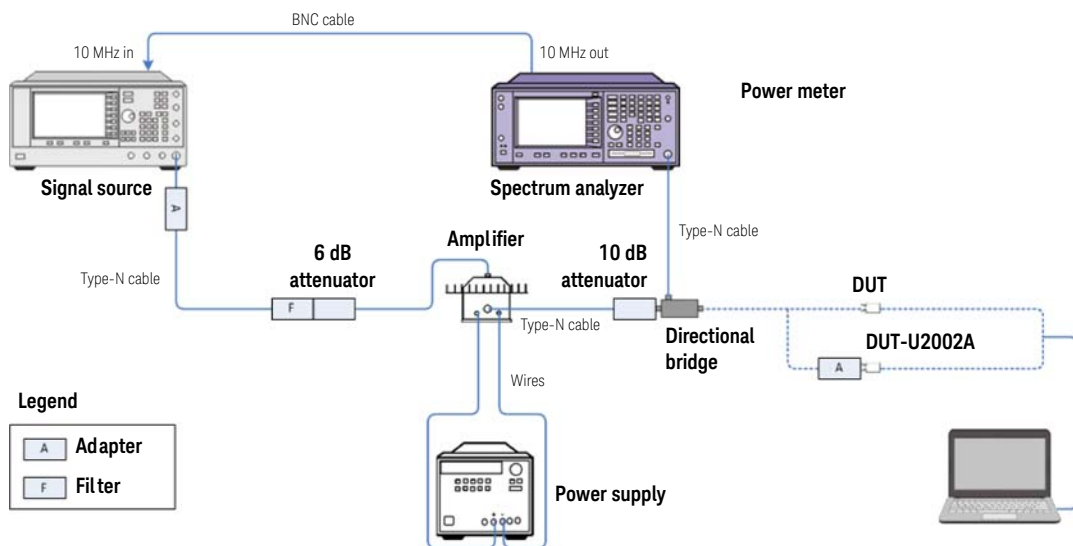

Figure 3-7 Sensor accuracy measurement setup for U200xA

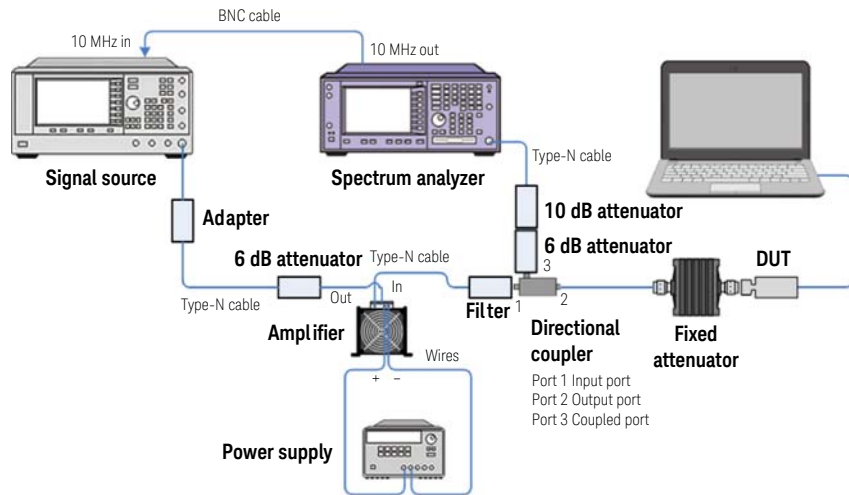

Figure 3-8 Sensor accuracy measurement setup for U200xB

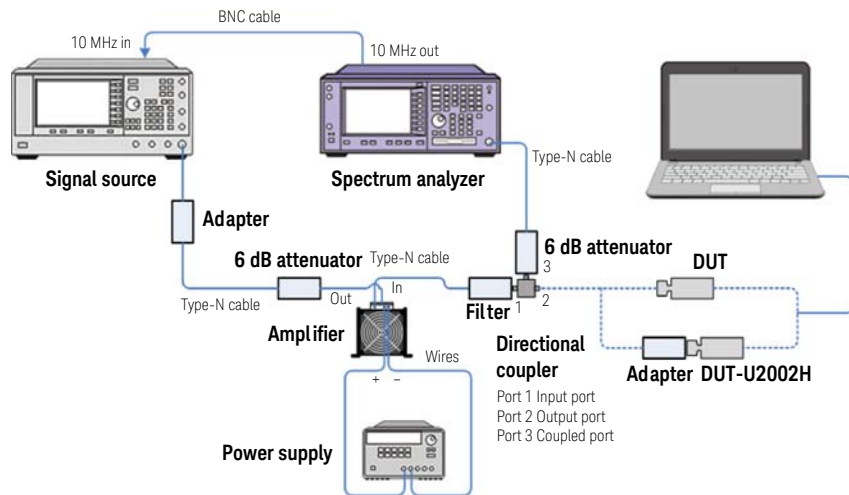

Figure 3-9 Sensor accuracy measurement setup for U200xH

- 5 Set the spectrum analyzer to the test point frequency of 50.025 MHz.

- 6 Set the signal generator frequency to the test point frequency of 50 MHz.
- 7 Set the desired test port power.
 - a Set the signal generator power amplitude, P_{sg} by using the P_{set} (refer to [step 8](#) of the “[Procedure to perform test system calibration](#)” on page 60) as a reference power level.
$$P_{sg} = P_{set} + P_{testport} \text{ (desired test port power)}$$
 - b Calculate the PSA desired measured power, P_{SA}
$$P_{testport} = P_{SA} + P_{trk}$$
$$P_{SA} = P_{testport} - P_{trk}$$
 - c Take a reading on the spectrum analyzer by pressing [Single]. Adjust the signal generator power and re-measure using the spectrum analyzer until the reading of the spectrum analyzer power is within ± 0.05 dB of PSA desired measured power (P_{SA}). Record the final spectrum analyzer reading for this test point as P_{SA} .
- 8 Read the power at DUT, P_{DUT} by sending the SCPI command [READ?](#).
$$\begin{aligned} \text{Power accuracy error} &= P_{DUT} - P_{testport} \\ &= P_{DUT} - P_{SA} - P_{trk} \\ &= P_{DUT} - P_{SA} - Pref_{PM} + Pref_{SA} \\ &= P_{DUT} + (Pref_{SA} - P_{SA}) - Pref_{PM} \end{aligned}$$
- 9 Repeat [step 7](#) and [step 8](#) according to the power range of the model in the data sheet. Compare the measured results to the specifications in the data sheet. If the verification fails, refer to “[Adjustments](#)” on page 67.

Adjustments

Adjustments are usually required on a yearly basis. They are normally performed only after a performance verification has indicated that some parameters are out of specification. Performance verification must be completed after any repairs that may have altered the characteristics of the U2000 Series.

The U2000 Series can be adjusted using the Keysight N7800 Series calibration software or can be returned to Keysight for adjustments. To arrange the return, contact the Keysight Service Center.

THIS PAGE HAS BEEN INTENTIONALLY LEFT BLANK.

4 Specifications and Characteristics

For the characteristics and specifications of the U2000 Series USB power sensors, refer to the datasheet at

<http://literature.cdn.keysight.com/litweb/pdf/5989-6278EN.pdf>

THIS PAGE HAS BEEN INTENTIONALLY LEFT BLANK.

5 Service

General Information	72
Replaceable Parts	73
Service	75
Troubleshooting	75

This chapter describes the performance test and provides information on replaceable parts as well as on service details.

General Information

This chapter contains information about general maintenance, performance tests, troubleshooting and the repair of U2000 Series USB power sensors.

Cleaning

Use a clean, damp cloth to clean the body of the U2000 Series USB power sensors.

Connector cleaning

CAUTION

The RF connector beads deteriorate when contacted with hydrocarbon compounds such as acetone, trichloroethylene, carbon tetrachloride, and benzene.

CAUTION

Clean the connector only at a static free workstation. Electrostatic discharge to the center pin of the connector will render the power sensor inoperative.

Keeping in mind its flammable nature, a solution of pure isopropyl or ethyl alcohol can be used to clean the connector.

Clean the connector face using a cotton swab dipped in isopropyl alcohol. If the swab is too big use, use a round wooden toothpick wrapped in a lint-free cotton cloth dipped in isopropyl alcohol.

Refer to *Keysight Application Note 326, Principles of Microwave Connector Care (5954-1566)* for proper cleaning methods.

Replaceable Parts

Table 5-1 contains a list of replaceable parts. To order a part, quote the Keysight part number, specify the quantity required, and address the order to the nearest Keysight office.

NOTE

Within the USA, it is better to order directly from the Keysight Parts Center in Roseville, California. Ask your nearest Keysight office for information and forms for the “Direct Mail Order System.” Also your nearest Keysight office can supply toll free telephone numbers for ordering parts and supplies.

Table 5-1 Replaceable parts

Model	Keysight Part Number	Qty	Description
U2000A	U2000-60006	1	U2000A replacement module
	5190-0062	1	Top label for U2000A
U2001A	U2001-60006	1	U2001A replacement module
	5190-0650	1	Top label for U2001A
U2002A	U2002-60006	1	U2002A replacement module
	5190-0651	1	Top label for U2002A
U2004A	U2004-60006	1	U2004A replacement module
	5190-0652	1	Top label for U2004A
U2000B	U2000-60007	1	U2000B replacement module
	5190-1710	1	Top label for U2000B
U2001B	U2000-60009	1	U2001B replacement module
	5190-1708	1	Top label for U2001B
U2000H	U2000-60008	1	U2000H replacement module
	5190-1709	1	Top label for U2000H
U2001H	U2000-60010	1	U2001H replacement module
	5190-1711	1	Top label for U2001H

Table 5-1 Replaceable parts (continued)

Model	Keysight Part Number	Qty	Description
U2002H	U2000-60011	1	U2002H replacement module
	5190-1712	1	Top label for U2002H
All models	5190-0061	2	Middle label
	5190-0060	1	Bottom label
	U2000-20001	1	Top cover
	U2000-20003	1	Bottom cover

Service

The following service instructions consist of information on troubleshooting, and repairs.

Troubleshooting

The U2000 Series USB power sensors represent a combination of a power meter and power sensor in one unit. If the LED is red and blinking, it indicates that there is a hardware error or operating system (OS) error in the power sensor. The LED will only be blinking red if the power sensor failed in the self-test. The command **SYSTEM:ERROr** is used to read the exact error messages which occur on the power sensor. Please kindly send the power sensor back to the nearest service center for repair. Refer to the “LED indicator guide” on page 22 for more information.

The maximum measurable power of a power sensor varies depending on the sensor model. Incidentally, Keysight Technologies’ service centers receive a high number of power sensor that have been damaged due to overpowering of the sensor bulkhead, resulting in the damage of the internal thin film circuit. Subjecting a power sensor module above its maximum allowable power rating is considered a misuse or self-abuse and is excluded from Keysight Technologies’ standard warranty coverage.

Refer to the *Power Sensor Overpower Failure Verification Guideline* at <https://literature.cdn.keysight.com/litweb/pdf/5992-4039EN.pdf>

CAUTION

Electrostatic discharge will render the power sensor inoperative. Do not, under any circumstances, open the power sensor unless you and the power sensor are in a static free environment.

Repairing a defective sensor

There are no serviceable parts inside the U2000 Series USB power sensors. If the sensor is defective, please send it back to the nearest Keysight Service Center for repair. The entire module of the defective sensor will be replaced with the appropriate replacement module. See [Table 5-1](#).

Disassembly and reassembly procedure



Disassembly procedure

Disassemble the power sensor by performing the following steps:

CAUTION

Disassemble the power sensor only in a static free workstation. Electrostatic discharge renders the power sensor inoperative.

Table 5-2 Disassembly procedure

	<p>1 Remove the top label.</p>
	<p>2 Loosen three screws by using M2 to remove the housing.</p>
	<p>3 Replace the defective sensor module with a new sensor module. Please refer to Table 5-1.</p>

Reassembly procedure

Tools required for reassembly:

Tools	Purpose	Qty	Torque value
M2 Torx	To fit the housing	1	3.98 lbs.in

Reassembly instructions:

The reassembly procedures are simply the reverse of the disassembly procedures.

Attenuator disassembly and reassembly procedure for U2000B and U2001B

Disassembly procedure

Tools required for disassembly:

Tools	Purpose	Torque value
¾" torque wrench	To loosen the attenuator	80 lbs.in
½" wrench	To prevent rotation	N/A

NOTE

The attenuator for U2000B and U2001B must not be disassembled under any circumstances except during annual calibration. Removing the attenuator for U2000B and U2001B will void the calibration.

Table 5-3 Attenuator disassembly procedure



- 1 Loosen the connector using the torque wrench.
- 2 After that clean the connector's threads with IPA. Ensure that the crystallized Loctite® adhesive is cleaned properly.

Reassembly procedure

Tools required for reassembly:

Tools	Purpose	Torque value
Loctite® Threadlocker Blue 242®	To secure the connection between the attenuator and the sensor's connector	N/A
3/4" torque wrench	To tighten the attenuator	12 lbs.in

Table 5-4 Attenuator reassembly procedure

- 1 Apply one drop of Loctite® adhesive on the first, second, and third threads of the connector.



- 2 Tighten the connector using the torque wrench.

THIS PAGE HAS BEEN INTENTIONALLY LEFT BLANK.

A Zero Set, Zero Drift, and Measurement Noise

Zero Set, Zero Drift, and Measurement Noise [82](#)

Zero Set, Zero Drift, and Measurement Noise

The following specifications in [Table A-1](#) are only applicable to the U2000 Series USB power sensors with the serial prefix as shown below:

Model	Serial prefix
U2000A	Serial Prefix MY470/SG470 and below
U2001A	Serial Prefix MY471/SG471 and below
U2002A	Serial Prefix MY472/SG472 and below
U2004A	Serial Prefix MY474/SG474 and below

Table A-1 Zero set, zero drift, and measurement noise for Average only mode

Range ^[a]	Zero set	Zero drift ^[b]	Measurement noise ^[c]
-60 dBm to -35 dBm	±651 pW	996 pW	1.91 nW
-38 dBm to -15 dBm	±1.13 nW	400 pW	2.24 nW
-20 dBm to -9 dBm	±12.8 nW	6.01 nW	40.8 nW
-11 dBm to -5 dBm	±445 nW	155 nW	1.63 μW
-7 dBm to 15 dBm	±4.26 μW	3.20 μW	861 nW
10 dBm to 20 dBm	±6.84 μW	3.39 μW	19.5 μW

[a] Condition: (i) 0 °C to 55 °C and (ii) 40 °C, 95% relative humidity.

[b] Within one hour after zero set, at a constant temperature, after 24-hour warm-up of the power sensor.

[c] The number of averages at 16 for Normal speed, measured over one minute interval and two standard deviations.



This information is subject to change without notice. Always refer to the Keysight website for the latest revision.

© Keysight Technologies 2007 - 2020
Edition 18, October 22, 2020

Printed in Malaysia



U2000-90405

www.keysight.com