X-Series Power Sensors

U2040 X-Series Wide Dynamic Range

Notices

Copyright Notice

© Keysight Technologies 2015-2022
No part of this manual may be reproduced in any form or by any means (including electronic storage and retrieval or translation into a foreign language) without prior agreement and written consent from Keysight Technologies as governed by United States and international copyright laws.

Manual Part Number

U2041-90003

Edition

Edition 7, November 24, 2022

Printed in:

Printed in Malaysia

Published by:

Keysight Technologies
Bayan Lepas Free Industrial Zone,
11900, Penang, Malaysia

Technology Licenses

The hardware and/or software described in this document are furnished under a license and may be used or copied only in accordance with the terms of such license.

Declaration of Conformity

Declarations of Conformity for this product and for other Keysight products may be downloaded from the Web. Go to <http://www.keysight.com/go/conformity>. You can then search by product number to find the latest Declaration of Conformity.

U.S. Government Rights

The Software is “commercial computer software,” as defined by Federal Acquisition Regulation (“FAR”) 2.101. Pursuant to FAR 12.212 and 27.405-3 and Department of Defense FAR Supplement (“DFARS”) 227.7202, the U.S. government acquires commercial computer software under the same terms by which the software is customarily provided to the public. Accordingly, Keysight provides the Software to U.S. government customers under its standard commercial license, which is embodied in its End User License Agreement (EULA), a copy of which can be found at <http://www.keysight.com/find/sweula>. The license set forth in the EULA represents the exclusive authority by which the U.S. government may use, modify, distribute, or disclose the Software. The EULA and the license set forth therein, does not require or permit, among other things, that Keysight: (1) Furnish technical information related to commercial computer software or commercial computer software documentation that is not customarily provided to the public; or (2) Relinquish to, or otherwise provide, the government rights in excess of these rights customarily provided to the public to use, modify, reproduce, release, perform, display, or disclose commercial computer software or commercial computer software documentation. No additional government requirements beyond those set forth in the EULA shall apply, except to the extent that those terms, rights, or licenses are explicitly required from all providers of commercial computer software pursuant to the FAR and the DFARS and are set forth specifically in writing elsewhere in the EULA. Keysight shall be under no obligation to update, revise or otherwise modify the Software. With respect to any technical data as defined by FAR 2.101, pursuant to FAR 12.211 and 27.404.2 and DFARS 227.7102, the U.S. government acquires no greater than Limited Rights as defined in FAR 27.401 or DFAR 227.7103-5 (c), as applicable in any technical data.

Warranty

THE MATERIAL CONTAINED IN THIS DOCUMENT IS PROVIDED “AS IS,” AND IS SUBJECT TO BEING CHANGED, WITHOUT NOTICE, IN FUTURE EDITIONS. FURTHER, TO THE MAXIMUM EXTENT PERMITTED BY APPLICABLE LAW, KEYSIGHT DISCLAIMS ALL WARRANTIES, EITHER EXPRESS OR IMPLIED, WITH REGARD TO THIS MANUAL AND ANY INFORMATION CONTAINED HEREIN, INCLUDING BUT NOT LIMITED TO THE IMPLIED WARRANTIES OF MERCHANTABILITY AND FITNESS FOR A PARTICULAR PURPOSE. KEYSIGHT SHALL NOT BE LIABLE FOR ERRORS OR FOR INCIDENTAL OR CONSEQUENTIAL DAMAGES IN CONNECTION WITH THE FURNISHING, USE, OR PERFORMANCE OF THIS DOCUMENT OR OF ANY INFORMATION CONTAINED HEREIN. SHOULD KEYSIGHT AND THE USER HAVE A SEPARATE WRITTEN AGREEMENT WITH WARRANTY TERMS COVERING THE MATERIAL IN THIS DOCUMENT THAT CONFLICT WITH THESE TERMS, THE WARRANTY TERMS IN THE SEPARATE AGREEMENT SHALL CONTROL.

Safety Information

CAUTION

A CAUTION notice denotes a hazard. It calls attention to an operating procedure, practice, or the like that, if not correctly performed or adhered to, could result in damage to the product or loss of important data. Do not proceed beyond a CAUTION notice until the indicated conditions are fully understood and met.

WARNING

A WARNING notice denotes a hazard. It calls attention to an operating procedure, practice, or the like that, if not correctly performed or adhered to, could result in personal injury or death. Do not proceed beyond a WARNING notice until the indicated conditions are fully understood and met.

Table of Contents

1	U2040 X-Series Remote Operation	
	Configuring the USB/LAN Interface	19
	Introduction to the SCPI Language	20
	Zeroing and Calibrating the U2040 X-Series	25
	Making Measurements	26
	Using Frequency-Dependent Offset Tables	37
	Setting the Averaging	44
	Setting Offsets	47
	Setting Measurement Limits	49
	Getting the Best Speed Performance	51
	How Measurements are Calculated	54
	Status Reporting	55
	Saving and Recalling U2040 X-Series Configurations	65
	Using Device Clear to Halt Measurements	66
	Making Measurements on Wireless Communication Standards	67
2	IEEE-488 Common Commands	
	*CLS	70
	*DDT	71
	*ESE	73
	*ESR?	74
	*IDN?	75
	*LRN?	76
	*OPC	77
	*OPT?	78
	*RCL	79
	*RST	80
	*SAV	81
	*SRE	82
	*STB?	83
	*TRG	84
	*TST	85
	*WAI	86

3	ABORt Subsystem	
	ABORt[1]	88
4	CALCulate Subsystem	
	CALCulate[1] 2 3 4:FEED[1] 2	90
	CALCulate[1] 2 3 4:GAIN:STATe	92
	CALCulate[1] 2 3 4:GAIN[:MAGNitude]	93
	CALCulate[1] 2 3 4:LIMit:CLEar:AUTO	94
	CALCulate[1] 2 3 4:LIMit:CLEar[:IMMEDIATE]	95
	CALCulate[1] 2 3 4:LIMit:FAIL?	96
	CALCulate[1] 2 3 4:LIMit:FCOunt?	97
	CALCulate[1] 2 3 4:LIMit:LOWer[:DATA]	99
	CALCulate[1] 2 3 4:LIMit:STATe	101
	CALCulate[1] 2 3 4:LIMit:UPPer[:DATA]	102
	CALCulate[1] 2 3 4:MATH [:EXPReSSion]	104
	CALCulate[1] 2 3 4:MATH [:EXPReSSion]:CATalogue?	105
	CALCulate[1] 2 3 4:PHOLD:CLEar	106
	CALCulate[1] 2 3 4:RELative:STATe	107
	CALCulate[1] 2 3 4:RELative[:MAGNitude]:AUTO	108
5	CALibration Subsystem	
	CALibration Subsystem	110
	CALibration[1]:AUTO	111
	CALibration[1]:ZERO:AUTO	112
	CALibration[1]:ZERO:TYPE	113
	CALibration[1]:ZERO:NORMal:AUTO	114
	CALibration[1][:ALL]	115
6	CONFigure Subsystem	
	CONFigure[1] 2 3 4[:SCALar][:POWer][:AC]	118
	CONFigure[1] 2 3 4[:SCALar][:POWer][:AC]:DIFFerence	119
	CONFigure[1] 2 3 4[:SCALar][:POWer][:AC]:DIFFerence:RELative	120
	CONFigure[1] 2 3 4[:SCALar][:POWer][:AC]:RATio	122
	CONFigure[1] 2 3 4[:SCALar][:POWer][:AC]:RATio:RELative	123
	CONFigure[1] 2 3 4[:SCALar][:POWer][:AC]:RELative	124
	CONFigure[1] 2 3 4?	125

7	FEtCh Subsystem	
	FEtCh[1]2 3 4[:SCALAr][:POWer][:AC]?	128
	FEtCh[1]2 3 4[:SCALAr][:POWer][:AC]:DIFFerence?	130
	FEtCh[1]2 3 4[:SCALAr][:POWer][:AC]:DIFFerence:RELative?	132
	FEtCh[1]2 3 4[:SCALAr][:POWer][:AC]:RATio?	134
	FEtCh[1]2 3 4[:SCALAr][:POWer][:AC]:RATio:RELative?	136
	FEtCh[1]2 3 4[:SCALAr][:POWer][:AC]:RELative?	138
8	FORMat Subsystem	
	FORMat[:READings]:BORDer	142
	FORMat[:READings][:DATA]	143
9	INITiate Subsystem	
	INITiate[1]:CONTInuous	146
	INITiate[1]:CONTInuous:ALL	147
	INITiate[1]:CONTInuous:SEQuence[1]	148
	INITiate[1][:IMMediate]	149
	INITiate[1][:IMMediate]:ALL	150
	INITiate[1][:IMMediate]:SEQuence[1]	151
10	INPut Subsystem	
	INPut:TRIGGer:IMPedance	154
11	LXI Subsystem	
	LXI:IDENTify[:STATe]	156
12	MEASure Subsystem	
	MEASure[1]2 3 4[:SCALAr][:POWer][:AC]?	158
	MEASure[1]2 3 4[:SCALAr][:POWer][:AC]:DIFFerence?	159
	MEASure[1]2 3 4[:SCALAr][:POWer][:AC]:DIFFerence:RELative?	160
	MEASure[1]2 3 4[:SCALAr][:POWer][:AC]:RATio?	161
	MEASure[1]2 3 4[:SCALAr][:POWer][:AC]:RATio:RELative?	162
	MEASure[1]2 3 4[:SCALAr][:POWer][:AC]:RELative?	163
13	MEMory Subsystem	
	MEMory:CATalog:STATe?	166
	MEMory:CATalog:TABLE?	167
	MEMory:CATalog[:ALL]?	168

MEMory:CLear:TABLE	169
MEMory:CLear[:NAME]	170
MEMory:FREE:STATe?	171
MEMory:FREE:TABLE?	172
MEMory:FREE[:ALL]?	173
MEMory:NStates?	174
MEMory:NTABles?	175
MEMory:STATe:CATalog?	176
MEMory:STATe:DEFine	177
MEMory:TABLE:FREQuency	178
MEMory:TABLE:FREQuency:POINts?	180
MEMory:TABLE:MOVE	181
MEMory:TABLE:GAIN[:MAGNitude]	182
MEMory:TABLE:GAIN[:MAGNitude]:POINts?	184
MEMory:TABLE:SElect	185
MEMory:TABLE:SGAMma	186
MEMory:TABLE:SGAMma:POINts?	187
MEMory:TABLE:SPARam	188
MEMory:TABLE:SPARam:POINts?	189

14 OUTPut Subsystem

OUTPut:TRIGger[1][:STATe]	192
---------------------------	-----

15 READ Subsystem

READ[1] 2 3 4[:SCALar][:POWer][:AC]?	194
READ[1] 2 3 4[:SCALar][:POWer][:AC]:DIFFerence?	196
READ[1] 2 3 4[:SCALar][:POWer][:AC]:DIFFerence:RELative?	198
READ[1] 2 3 4[:SCALar][:POWer][:AC]:RATio?	200
READ[1] 2 3 4[:SCALar][:POWer][:AC]:RATio:RELative?	202
READ[1] 2 3 4[:SCALar][:POWer][:AC]:RELative?	204

16 SENSE Subsystem

[:SENSe[1]:]AVERAge2:COUNT	209
[:SENSe[1]:]AVERAge2[:STATe]	210
[:SENSe[1]:]AVERAge:COUNT	211
[:SENSe[1]:]AVERAge:COUNT:AUTO	213

[[:SENSe[1]:]AVERage:RESet	215
[[:SENSe[1]:]AVERage:SDETect	216
[[:SENSe[1]:]AVERage[:STATe]	217
[[:SENSe[1]:]BANDwidth BWIDth:VIDeo	218
[[:SENSe[1]:]BANDwidth BWIDth:VIDeo:STATe	219
[[:SENSe[1]:]BUFFer:COUNT	220
[[:SENSe[1]:]BUFFer:MTYPe	221
[[:SENSe[1]:]CORRection:CSET2:STATe	222
[[:SENSe[1]:]CORRection:CSET3:STATe	223
[[:SENSe[1]:]CORRection:CSET4:STATe	224
[[:SENSe[1]:]CORRection:CSET2[:SElect]	225
[[:SENSe[1]:]CORRection:CSET3[:SElect]	227
[[:SENSe[1]:]CORRection:CSET4[:SElect]	228
[[:SENSe[1]:]CORRection:DCYClE GAIN3:STATe	229
[[:SENSe[1]:]CORRection:DCYClE GAIN3[:INPut][:MAGNitude]	230
[[:SENSe[1]:]CORRection:FDOFFset GAIN4[:INPut][:MAGNitude]?]	232
[[:SENSe[1]:]CORRection:GAIN2[:INPut]:STATe	233
[[:SENSe[1]:]CORRection:GAIN2[:INPut][:MAGNitude]	234
[[:SENSe[1]:]CORRection:LOSS2[:INPut]:STATe	235
[[:SENSe[1]:]CORRection:LOSS2[:INPut][:MAGNitude]	236
[[:SENSe[1]:]CORRection:SGAMma?	237
[[:SENSe[1]:]CORRection:SGAMma:STATe	238
[[:SENSe[1]:]CORRection:SGAMma:MAGNitude	239
[[:SENSe[1]:]CORRection:SGAMma:PHASe	240
[[:SENSe[1]:]CORRection:SPARam?	241
[[:SENSe[1]:]DETEctor:FUNCTion	242
[[:SENSe[1]:]FREQUency[:CW]:FIXed]	243
[[:SENSe[1]:]FREQUency[:CW]:FIXed]:START	244
[[:SENSe[1]:]FREQUency[:CW]:FIXed]:STOP	246
[[:SENSe[1]:]FREQUency[:CW]:FIXed]:STEP	248
[[:SENSe[1]:]LIST:FREQUency:START	250
[[:SENSe[1]:]LIST:FREQUency:STOP	251
[[:SENSe[1]:]LIST:MTYPe	252
[[:SENSe[1]:]LIST:POINts	253

[:SENSe[1:]]LIST:STATe	254
[:SENSe[1:]]LIST:TSCoUnt	255
[:SENSe[1:]]LIST:TSLot:EXCLude:OFFSet:TIME	257
[:SENSe[1:]]LIST:TSLot:EXCLude:TIME	258
[:SENSe[1:]]LIST:TSLot:TIME	259
[:SENSe[1:]]LIST:TSLot:TREF1	260
[:SENSe[1:]]LIST:TSLot:TREF2	261
[:SENSe[1:]]MRATe	262
[:SENSe[1:]]SWEEp:[1] 2 3 4:AUTO	264
[:SENSe[1:]]SWEEp:[1] 2 3 4:AUTO:REF1 REF2	265
[:SENSe[1:]]SWEEp[1] 2 3 4:OFFSet:TIME	266
[:SENSe[1:]]SWEEp[1] 2 3 4:TIME	267
[:SENSe[1:]]SWEEp:APERture	268
[:SENSe[1:]]SWEEp:APERture:AUTO	270
[:SENSe[1:]]TEMPerature?	271
[:SENSe[1:]]TRACe:MEMemory:SIZE	272
[:SENSe[1:]]TRACe:OFFSet:TIME	274
[:SENSe[1:]]TRACe:TIME	275
[:SENSe[1:]]TRACe:UNIT	276
[:SENSe[1:]]TRACe:AUToscale	277

17 SERVICE Subsystem

SERVICE:BIST:CW:ZSET:NUMber?	280
SERVICE:BIST:PEAK[1]:LINearity	281
SERVICE:BIST:PEAK[1]:LINearity:PERRor?	282
SERVICE:BIST:PEAK[1]:ZSET	283
SERVICE:BIST:PEAK[1]:ZSET:NUMber?	284
SERVICE:BIST:RAM:MODE <character_data>	285
SERVICE:BIST:TBASE:STATe	286
SERVICE:LAN:PHOStname	287
SERVICE:SECure:ERASe	288
SERVICE:SENSor[1]:CDATe?	289
SERVICE:SENSor[1]:CPLace?	290
SERVICE:SENSor[1]:FREQUency:MAXimum?	291
SERVICE:SENSor[1]:FREQUency:MINimum?	292

SERvice:SENSor[1]:POWer:AVERAge:MAXimum?	293
SERvice:SENSor[1]:POWer:PEAK:MAXimum?	294
SERvice:SENSor[1]:POWer:USABLE:MAXimum?	295
SERvice:SENSor[1]:POWer:USABLE:MINimum?	296
SERvice:SENSor[1]:RADc?	297
SERvice:SENSor[1]:SNUMber?	298
SERvice:SENSor[1]:TYPE?	299
SERvice:SNUMber?	300

18 STATus Subsystem

STATus Subsystem	302
Status Register Set Commands	304
Device Status Register Sets	307
Operation Register Sets	308
STATus:OPERation	309
STATus:OPERation:CALibrating[:SUMMARY]	310
STATus:OPERation:LLFail[:SUMMARY]	311
STATus:OPERation:MEASuring[:SUMMARY]	312
STATus:OPERation:SENSe[:SUMMARY]	313
STATus:OPERation:TRIGger[:SUMMARY]	314
STATus:OPERation:ULFail[:SUMMARY]	315
STATus:PRESet	316
Questionable Register Sets	317
STATus:QUEStionable	318
STATus:QUEStionable:CALibration[:SUMMARY]	319
STATus:QUEStionable:POWer:CHA	320
STATus:QUEStionable:POWer[:SUMMARY]	321
Status Block Diagram	322

19 SYSTem Subsystem

SYSTem:COMMunicate:LAN:AIP[:STATe]	324
SYSTem:COMMunicate:LAN:DHCP[:STATe]	325
SYSTem:COMMunicate:LAN:ADDResS	326
SYSTem:COMMunicate:LAN:DGATeway	327
SYSTem:COMMunicate:LAN:DNAMe	328

SYSTem:COMMunicate:LAN:HNAME	329
SYSTem:COMMunicate:LAN:MAC	330
SYSTem:COMMunicate:LAN:SMASK	331
SYSTem:COMMunicate:LAN:REStart	332
SYSTem:COMMunicate:LAN:CURRent:ADDRes?	333
SYSTem:COMMunicate:LAN:CURRent:DGATeway?	334
SYSTem:COMMunicate:LAN:CURRent:DNAMe?	335
SYSTem:COMMunicate:LAN:CURRent:SMASK?	336
SYSTem:COMMunicate:LAN:KEEPAlive	337
SYSTem:COMMunicate:TCPIP:CONTRol?	339
SYSTem:ERRor?	340
SYSTem:HELp:HEADers?	345
SYSTem:PRESet	346
SYSTem:SET	403
SYSTem:VERSion?	404

20 TRACe Subsystem

TRACe[1]:STATe	406
TRACe[1]:UNIT	407
TRACe[1][:DATA]?	408
TRACe[1]:DEFine:DURation:REFerence	411
TRACe[1]:DEFine:TRANSition:REFerence	412
TRACe[1]:MEASurement:REFerence?	413
TRACe[1]:MEASurement:INSTant:REFerence?	414
TRACe[1]:MEASurement:PULSe[1] 2 3 4 5 6 7 8 9 ..20:AM?	415
TRACe[1]:MEASurement:PULSe[1] 2 3 4 5 6 7 8 9 ..20:AT?	416
TRACe[1]:MEASurement:PULSe[1] 2 3 4 5 6 7 8 9 ..20:DCYCLe?	417
TRACe[1]:MEASurement:PULSe[1] 2 3 4 5 6 7 8 9 ..20:DURation?	418
TRACe[1]:MEASurement:PULSe[1] 2 3 4 5 6 7 8 9 ..20:PERiod?	419
TRACe[1]:MEASurement:PULSe[1] 2 3 4 5 6 7 8 9 ..20:SEPARation?	420
TRACe[1]:MEASurement:PULSe[1] 2 3 4 5 6 7 8 9 ..20:TILT?	421
TRACe[1]:MEASurement:TRANSition[1] 2 3 4 5 6 7 8 9 ..20:NEGative:DURation?	422
TRACe[1]:MEASurement:TRANSition[1] 2 3 4 5 6 7 8 9 ..20:NEGative:OCCurrence?	423

TRACe[1]:MEASurement:TRANSition[1] 2 3 4 5 6 7 8 9 ..20:POSitive:DURati on?	424
TRACe[1]:MEASurement:TRANSition[1] 2 3 4 5 6 7 8 9 ..20:POSitive:OCCur ence?	425
TRACe[1]:MEASurement:TILT:UNIT	426
TRACe[1]:OFFSet:TIME	427
TRACe[1]:TIME	428
TRACe[1]:AUToscale	429

21 TRIGger Subsystem

TRIGger[1]:SEQuence[1]:COUNT	432
TRIGger[1]:SEQuence[1]:DELay	434
TRIGger[1]:SEQuence[1]:DELay:AUTO	436
TRIGger[1]:SEQuence[1]:HOLDoff	437
TRIGger[1]:SEQuence[1]:HYSTeresis	438
TRIGger[1]:SEQuence[1]:[IMMEDIATE]	439
TRIGger[1]:SEQuence[1]:LEVel	440
TRIGger[1]:SEQuence[1]:LEVel:AUTO	441
TRIGger[1]:SEQuence[1]:QUALifier:TIME	442
TRIGger[1]:SEQuence[1]:SLOPe	443
TRIGger[1]:SEQuence[1]:SOURce	444

22 UNIT Subsystem

UNIT[1] 2 3 4:POWer	448
UNIT[1] 2 3 4:POWer:RATio	449

23 Programming Examples

Example 1: Two Time Slot GSM Measurement	452
Example 2: Achieve Measurement Speed of >20000 Readings/s ...	453
Example 3: Achieve Fast Measurement Speed of 50000 Readings/s .	455
Example 4: Capture Every Timeslot in GSM Frames	456

THIS PAGE HAS BEEN INTENTIONALLY LEFT BLANK.

List of Figures

Figure 1-1	Frequency-dependent offset tables	38
Figure 1-2	Typical averaged readings	45
Figure 1-3	Typical averaged readings (continued)	46
Figure 1-4	Dynamic range hysteresis	46
Figure 1-5	Limits checking results	49
Figure 1-6	How measurements are calculated	54
Figure 1-7	Generalized status register model	55
Figure 1-8	Typical status register bit changes	56
Figure 1-9	Status system	58
Figure 19-1	IEEE-488.2 arbitrary block program data format	345

THIS PAGE HAS BEEN INTENTIONALLY LEFT BLANK.

List of Tables

Table 1-1	MEASure? and CONFIgure preset states	26
Table 1-2	Range of values for limits	49
Table 1-3	Bit definitions - Status byte register	59
Table 1-4	Bit definitions - Standard event register	60
Table 1-5	Bit definitions - Questionable status registers	61
Table 1-6	Bit change conditions for questionable status register	61
Table 1-7	Bit definitions - Operation status	62
Table 1-8	Bit change conditions for operation status	62
Table 1-9	Bit definitions - Device status register	63
Table 1-10	Bit change conditions for device status register	63
Table 2-1	*ESE mapping	73
Table 2-2	*ESR? mapping	74
Table 2-3	*SRE mapping	82
Table 2-4	*STB? mapping	83
Table 4-1	Measurement units	99
Table 4-2	Measurement units	102
Table 13-1	Frequency and offset factor list	182
Table 18-1	Commands and events affecting the status register	302
Table 19-1	DEFAult: U2040 X-Series presets	348
Table 19-2	GSM900: U2040 X-Series presets	350
Table 19-3	GSM900: U2040 X-Series presets for calc setup	351
Table 19-4	EDGE: U2040 X-Series presets	352
Table 19-5	EDGE: U2040 X-Series presets for calc setup	353
Table 19-6	NADC: U2040 X-Series presets	355
Table 19-7	NADC: U2040 X-Series presets for calc setup	356
Table 19-8	BLUetooth: U2040 X-Series presets	358
Table 19-9	BLUetooth: U2040 X-Series presets for calc setup	359
Table 19-10	CDMAone: U2040 X-Series presets	360
Table 19-11	CDMAone: U2040 X-Series presets for calc setup	361
Table 19-12	W-CDMA: U2040 X-Series presets	363
Table 19-13	W-CDMA: U2040 X-Series presets for calc setup	364
Table 19-14	CDMA2000: U2040 X-Series presets	366
Table 19-15	CDMA2000: U2040 X-Series presets for calc setup	367
Table 19-16	iDEN: U2040 X-Series presets	369
Table 19-17	iDEN: U2040 X-Series presets for calc setup	370
Table 19-18	MCPa: U2040 X-Series presets	372
Table 19-19	MCPa: U2040 X-Series presets for calc setup	373
Table 19-20	RADar: U2040 X-Series presets	374

Table 19-21	RADar: U2040 X-Series presets for calc setup	375
Table 19-22	WL802DOT11A: U2040 X-Series presets	376
Table 19-23	WL802DOT11A: U2040 X-Series presets for calc setup	377
Table 19-24	WL802DOT11B: U2040 X-Series presets	378
Table 19-25	WL802DOT11B: U2040 X-Series presets for calc setup	379
Table 19-26	XEVDO: U2040 X-Series presets	380
Table 19-27	XEVDO: U2040 X-Series presets for calc setup	381
Table 19-28	XEVDV: U2040 X-Series presets	382
Table 19-29	XEVDV: U2040 X-Series presets for calc setup	383
Table 19-30	TDSCdma: U2040 X-Series presets	384
Table 19-31	TDSCdma: U2040 X-Series presets for calc setup	385
Table 19-32	DVB: U2040 X-Series presets	386
Table 19-33	TDVB: U2040 X-Series presets for calc setup	387
Table 19-34	HIPERLAN2: U2040 X-Series presets	388
Table 19-35	HIPERLAN2: U2040 X-Series presets for calc setup	389
Table 19-36	WIMAX: U2040 X-Series presets	390
Table 19-37	WIMAX: U2040 X-Series presets for calc setup	391
Table 19-38	HSDPA: U2040 X-Series presets	392
Table 19-39	HSDPA: U2040 X-Series presets for calc setup	393
Table 19-40	DME: U2040 X-Series presets	394
Table 19-41	DME: U2040 X-Series presets for calc setup	395
Table 19-42	DMEPRT: U2040 X-Series presets	396
Table 19-43	DMEPRT: U2040 X-Series presets for calc setup	397
Table 19-44	LTEFDD: U2040 X-Series presets	398
Table 19-45	LTEFDD: U2040 X-Series presets for calc setup	399
Table 19-46	LTETDD: U2040 X-Series presets	400
Table 19-47	LTETDD: U2040 X-Series presets for calc setup	401

Keysight U2040 X-Series
Wide Dynamic Range Power Sensors
Programming Guide

1 U2040 X-Series Remote Operation

Configuring the USB/LAN Interface	19
Introduction to the SCPI Language	20
Mnemonic forms	20
Using a colon “:”	20
Using a semicolon “;”	20
Using a comma “,”	21
Using whitespace	21
Using “?” commands	21
Using “*” commands	21
Syntax conventions	22
SCPI data types	22
Input message terminators	24
Zeroing and Calibrating the U2040 X-Series	25
Zeroing	25
Calibration	25
Making Measurements	26
Using MEASure?	26
Using the CONFigure command	29
Using the lower-level commands	36
Using Frequency-Dependent Offset Tables	37
Setting the Averaging	44
Overview	37
Editing frequency-dependent offset tables	39
Selecting a frequency-dependent offset table	42
Enabling a frequency-dependent offset table	42
Making the measurement	42
Setting Offsets	47
Averaging	44
Auto-averaging mode	44
Filter length	46
Setting Measurement Limits	49
Channel offsets	47

CALCulate offsets	47
Getting the Best Speed Performance	51
Setting limits	49
Checking for limit failures	50
How Measurements are Calculated	54
Measurement rate	51
Trigger mode	51
Output format	53
Units	53
Command used	53
Fast mode	53
Status Reporting	55
Saving and Recalling U2040 X-Series Configurations	65
The general status register model	55
How to use registers	57
Device Status register	63
Using the Operation Complete commands	64
Using Device Clear to Halt Measurements	66
How to save and recall a configuration	65
Making Measurements on Wireless Communication Standards	67
Starting a preset example	68

This chapter describes the parameters that configure the U2040 X-Series, and helps you determine the settings to optimize performance.

Configuring the USB/LAN Interface

The USB interface requires no front panel or remote configuration.

Before connecting the USB/LAN cable, make sure that the Keysight IO Libraries software is installed on your PC.

NOTE

For further information on connecting and verifying the U2040 X-Series via USB/LAN, refer to the *U2040 X-Series User's Guide*.

NOTE

- For more information on configuring the USB/LAN remote interface connectivity, refer to the *Keysight USB/LAN/GPIB Interfaces Connectivity Guide*.
 - If you have installed the IO Libraries Suite, you can access the Connectivity Guide via the IO Libraries Control icon or via the Web at www.keysight.com/find/connectivity.
 - If you have installed other I/O software, refer to the documentation that accompanies the software.
-

Introduction to the SCPI Language

Standard Commands for Programmable Instruments (SCPI) is an ASCII-based instrument command language designed for test and measurement instruments. SCPI commands are based on a hierarchical structure, also known as a tree system. In this system, associated commands are grouped together under a common node or root, thus forming subsystems. A portion of the SYSTem subsystem is shown below to illustrate the tree system.

SYSTem:

```
PRESet [<character_data>[,<character_data>]]
```

SYSTem is the root keyword of the command and PRESet is the second-level keyword. A colon ":" separates a command keyword from a lower-level keyword.

Mnemonic forms

Each keyword has both a long and a short form. A standard notation is used to differentiate the short-form keyword from the long-form keyword. The long form of the keyword is shown, with the short-form portion shown in upper-case characters, and the rest of the keyword shown in lower-case characters. For example, the short form of TRIGger is TRIG.

Using a colon ":"

When a colon is the first character of a command keyword, it indicates that the next command mnemonic is a root-level command. When a colon is inserted between two command mnemonics, the colon moves the path down one level in the present path (for the specified root-level command) of the command tree. You must separate command mnemonics from each other using a colon. *You can omit the leading colon if the command is the first of a new program line.*

Using a semicolon ";"

Use a semicolon to separate two commands within the same command string. The semicolon does not change the present path specified. For example, the following two statements are equivalent. Note that in the first statement, the first colon is optional but the third is compulsory.

```
SENS: AVER ON; SENS: AVER: COUN 1
```

```
SENS: AVER ON; AVER: COUN 1
```

Using a comma “,”

If a command requires more than one parameter, you must separate adjacent parameters using a comma.

Using whitespace

You must use whitespace characters, [tab], or [space] to separate a parameter from a command keyword. Whitespace characters are generally ignored only in parameter lists.

Using “?” commands

The bus controller may send commands at any time, but a SCPI instrument may only send responses when specifically instructed to do so. Only queries (commands that end with a “?”) instruct the instrument to send a response message. Queries return either measured values or internal instrument settings.

NOTE

If you send two queries without reading the response from the first, then attempt to read the second response, you may receive some data from the first response followed by the complete second response. To avoid this, do not send a query without reading the response.

Using “*” commands

Commands starting with a “*” are called common commands. They are required to perform the identical function for all instruments that are compliant with the IEEE-488 interface standard. The “*” commands are used to control the reset, clear status, identification request, self-test, wait-before-execution, and status operations in the U2040 X-Series.

Syntax conventions

Throughout this programming guide, the following conventions are used for SCPI command syntax:

- Square brackets “[]” indicate optional keywords or parameters and can be omitted. The brackets are not sent with the command string. If you do not specify a value for an optional parameter, the instrument chooses a default value.
- Braces “{}” enclose one or more parameters that may be included zero or more times. The brackets are not sent with the command string.
- Triangle brackets “<>” indicate that you must substitute a value for the enclosed parameter. The brackets are not sent with the command string.
- Parenthesis “()” enclose parameters that are usually a channel list.
- Vertical bars “|” can be read as “or” and are used to separate alternative parameter options.

SCPI data types

The SCPI language defines different data formats for use in program messages and response messages. Instruments are flexible listeners and can accept commands and parameters in various formats. However, SCPI instruments are precise talkers. This means that SCPI instruments always respond to a particular query in a predefined, rigid format.

<boolean> definition

Throughout this document, <boolean> is used to represent ON | OFF | <NRf>. Boolean parameters have a value of 0 or 1 and are unitless. ON corresponds to 1 and OFF corresponds to 0.

On input, an <NRf> is rounded to an integer. A nonzero result is interpreted as 1.

Queries always return a 1 or 0, never ON or OFF.

<character_data> definition

Throughout this document, <character_data> is used to represent character data, that is, A–Z, a–z, 0–9, and _ (underscore). For example: START and R6_5F.

<NAN> definition

Not a number (NAN) is represented as 9.91E37. Not a number is defined in IEEE 754.

<non-decimal numeric> definition

Throughout this document, <non-decimal numeric> is used to represent numeric information in bases other than 10 (that is, hexadecimal, octal, and binary). For example: #HA2F, #ha4e, #Q62, #q15, and #B01011. Refer to section 7.7.4.1 of IEEE 488.2 for further details.

<NRf> definition

Throughout this document, <NRf> is used to denote a flexible numeric representation. For example: +200, -56, and +9.9E36. Refer to section 7.7.2.1 of IEEE 488.2 for further details.

<NR1> definition

Throughout this document, the <NR1> numeric response data is used to denote a numeric representation including optional signs. For example: 146, +146, and -12345. Refer to section 8.7.2 of IEEE 488.2 for further details.

<NR2> definition

Throughout this document, the <NR2> numeric response data is used to denote a numeric representation including optional signs and decimal points. For example: 12.3, +1.2345, and -0.123. Refer to section 8.7.3 of IEEE 488.2 for further details.

<NR3> definition

Throughout this document, the <NR3> numeric response data is used to denote a numeric representation including optional signs, decimal points, and scientific notation. For example: 1.23E+6, 123.4E-54, and -1234.567E+90. Refer to section 8.7.4 of IEEE 488.2 for further details.

<numeric_value> definition

Throughout this document, the decimal numeric element is abbreviated to <numeric_value>. For example: <NRf>, MINimum, MAXimum, DEFault, or Not A Number (NaN).

<string> definition

Throughout this document, <string> is used to represent 7-bit ASCII characters. A string must begin and end with matching quotes, either with a single quote or a double quote. You can include the quote delimiter as part of the string by typing it twice without any characters in between.

Input message terminators

Program messages sent to a SCPI instrument must terminate with a <newline> character. The IEEE.488 EOI (end or identify) signal is interpreted as a <newline> character and may also be used to terminate a message in place of the <newline> character. A <carriage return> followed by a <newline> is also accepted. Many programming languages allow you to specify a message terminator character or EOI state to be automatically sent with each bus transaction. Message termination always sets the current path back to the root-level.

Zeroing and Calibrating the U2040 X-Series

Zeroing

Zeroing adjusts the U2040 X-Series for a zero power reading.

The command `CALibration[1]:ZERO:AUTO [ONCE|ON|OFF|0|1]` causes the U2040 X-Series to perform its auto-zeroing routine when enabled.

When `1` or `ON` is specified, zero is maintained by a combination of zero on-the-fly for measurements and temperature compensation.

Zeroing of the U2040 X-Series occurs automatically:

- on power up.
- every 5 seconds [only applicable for the `NORMa1` (peak) path].

Calibration

The command used to auto-calibrate the U2040 X-Series is:

```
CALibration[1]:AUTO ONCE
```

It is recommended that you zero the U2040 X-Series before calibrating.

`CALibration[1][:ALL]` allows you to perform calibration with a single command. This calibration consists of zeroing the U2040 X-Series.

You can query the calibration status by sending `CALibration[1][:ALL]?`.

If the result is `0`, the calibration is successful. If the result is `1`, the calibration has failed.

NOTE

The `CALibration[1][:ALL]` command is identical to the `CALibration[1][:ALL]?` query except that no number is returned to indicate the outcome of the calibration sequence. You can examine the Questionable Status Register or the error queue to determine if the sequence has passed or failed. Refer to “**Status Reporting**” on page 55 for further information.

Making Measurements

The `MEASure?` and `CONFigure` commands provide a straightforward method to program the U2040 X-Series for measurements. You can select the measurement expected power level, resolution, and measurement type (single channel, difference, or ratio measurements) in one command. The U2040 X-Series automatically presets other measurement parameters to the default values as shown in **Table 1-1** below.

Table 1-1 MEASure? and CONFigure preset states

Command	MEASure? and CONFigure settings
Trigger source (<code>TRIGger:SOURce</code>)	Immediate
Filter (<code>[[:SENSe[1]:]AVERage:COUNT:AUTO)</code>)	On
Filter state (<code>[[:SENSe[1]:]AVERage[:STATe])</code>)	On
Trigger cycle (<code>INITiate:CONTinuous</code>)	Off
Trigger delay (<code>TRIGger:DElay:AUTO)</code>)	On

An alternative method to program the U2040 X-Series is to use the lower-level commands. The advantage of using the lower-level commands over the `MEASure?` query and `CONFigure` command is that they give you more precise control of the U2040 X-Series. As shown in **Table 1-1**, the `CONFigure` command presets various states in the U2040 X-Series. It may be likely that you do not want to preset these states. Refer to “**Using the lower-level commands**” on page 36 for further information.

Using MEASure?

The simplest way to program the U2040 X-Series for measurements is by using the `MEASure?` query. However, this query does not offer much flexibility. When you execute the query, the U2040 X-Series selects the best settings for the requested configuration and immediately performs the measurement. You cannot change any settings (other than the expected power value, resolution, and measurement type) before the measurement is taken. This means you cannot fine tune the measurement, for example, you cannot change the filter length. To make more flexible and accurate measurements, use the `CONFigure` command. `MEASure?` is a compound command which is equivalent to an `ABORt`, followed by a `CONFigure` and a `READ?`.

MEASure? examples

The following commands show a few examples of how to use the MEASure? query to make a measurement. It is advisable to read through these examples in order as they become increasingly more detailed. These examples configure the U2040 X-Series for a measurement (as described in each individual example), automatically place the U2040 X-Series in the “wait-for-trigger” state, internally trigger the U2040 X-Series to take one reading, and then send the reading to the output buffer.

These examples give an overview of the MEASure? query. For further information on MEASure?, refer to **Chapter 12**, “MEASure Subsystem”.

Example 1: The simplest method

The following commands show the simplest method of making measurements: using MEAS1? results in a CALCulate1 measurement, and MEAS2? in a CALCulate2 measurement. The channel can be set using the source list parameter (see “**Specifying the source list parameter**” on page 27), or defaults as in this example.

specifies CALCulate subsystem



MEAS1?

MEAS2?

Example 2: Specifying the source list parameter

The MEASure? query has three optional parameters: an expected power value, a resolution, and a source list. These parameters must be entered in the specified order. If parameters are omitted, they default from the right. The parameter DEFault is used as a placeholder.

The source list parameter is used to specify a measurement channel. The U2040 X-Series supports only one channel. Therefore, the only valid value is (@1). The expected power and resolution parameters are set to their default values, leaving them at their current settings.

specifies CALCulate subsystem

specifies channel



MEAS1? DEF, DEF, (@1)

Example 3: Specifying the expected power parameter

The previous example details the three optional parameters which can be used with the MEASure? query. The first optional parameter is used to enter an expected power value.

The following example uses the expected value parameter to specify a value of -30 dBm. The resolution parameter is defaulted, leaving it at its current setting.

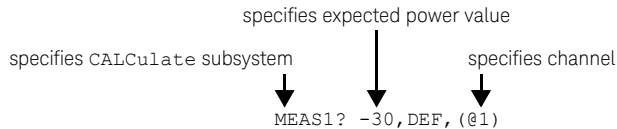

Example 4: Specifying the resolution parameter

The previous examples detailed the use of the expected value and source list parameters. The resolution parameter is used to set the resolution of the specified CALCulate subsystem. This parameter does not affect the resolution of the data; however it does affect the auto-averaging setting (refer to **Figure 1-2**).

The following example uses the resolution parameter to specify a resolution setting of 3. This setting represents three significant digits if the measurement suffix is W or %, and 0.01 dB if the suffix is dB or dBm.

Refer to **Chapter 12**, "MEASure Subsystem" for further details on the resolution parameter. The expected power and source list parameters are defaulted in the example. The expected power value remains unchanged at its current setting. Note that as the source list parameter is the last specified parameter, you do not have to specify DEF.

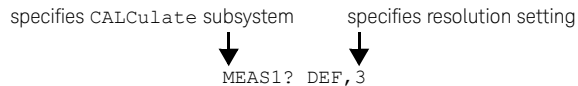

Example 5: Making a difference measurement

The following example queries the CALCulate2 subsystem to make a difference measurement of Channel A – Channel A. The expected power level and resolution parameters are defaulted, leaving them at their current settings.

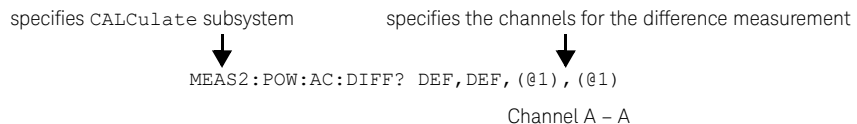

Example 6: Making a ratio measurement

The following example queries the `CALCulate1` subsystem to make a ratio measurement of Channel A/A. The expected power level and resolution parameters are defaulted, leaving them at their current settings.

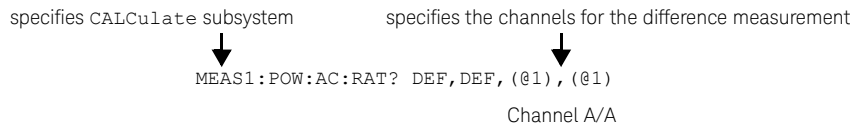

Using the `CONFigure` command

When you execute this command, the U2040 X-Series presets the optimum settings for the requested configuration (like the `MEASure?` query). However, the measurement is not automatically started and you can change measurement parameters before making measurements. This allows you to change the U2040 X-Series configuration from the preset conditions. The U2040 X-Series offers a variety of low-level commands in the `SENSE`, `CALCulate`, and `TRIGger` subsystems. For example, if you want to change the averaging, use the `[:SENSE[1] :]AVERage:COUNT` command.

Use the `INITiate` or `READ?` query to initiate the measurement.

Using `READ?`

`CONFigure` does not take the measurement. One method of obtaining a result is to use the `READ?` query. The `READ?` query takes the measurement using the parameters set by the `CONFigure` command and then sends the reading to the output buffer. Using the `READ?` query obtains new data.

Using `INITiate` and `FETCh?`

`CONFigure` does not take the measurement. One method of obtaining the result is to use the `INITiate` and `FETCh?` commands. The `INITiate` command causes the measurement to be taken. The `FETCh?` query retrieves a reading when the measurement is complete and sends the reading to the output buffer. `FETCh?` can be used to obtain the measurement results in a number of different formats without taking fresh data for each measurement.

CONFigure examples

The following program segments show how to use the commands `READ?`, `INITiate`, `FETCh?`, and `CONFigure` to make measurements.

It is advisable to read through these examples in order as they become increasingly more detailed.

These examples give an overview of the `CONFigure` command. For further information on the `CONFigure` commands, refer to **Chapter 6**, "CONFigure Subsystem".

Example 1: The simplest method

The following program segments show the simplest method of querying the measurement results of the `CALCulate` subsystem.

Using `READ?`

```
*RST           Resets the U2040 X-Series.
CONF1         Configures CALCulate1 – defaults to a Channel A measurement.
READ1?       Takes the CALCulate1 measurement.
```

```
*RST           Resets the U2040 X-Series
CONF2         Configures CALCulate2 – defaults to a Channel A measurement.
READ2?       Takes the CALCulate2 measurement.
```

Using `INITiate` and `FETCh?`

```
*RST           Resets the U2040 X-Series.
CONF1         Configures CALCulate1 – defaults to a Channel A measurement.
INIT1?       Causes Channel A to make a measurement.
FETC1?       Retrieves the CALCulate1 measurement.
```

```
*RST           Resets the U2040 X-Series.
CONF2         Configures CALCulate2 – defaults to a Channel A measurement.
INIT1         Causes Channel A to make a measurement.
FETC2?       Retrieves the CALCulate2 measurement.
```

Example 2: Specifying the source list parameter

The `CONFiGure` and `READ?` commands have three optional parameters: an expected power value, a resolution, and a source list. These parameters must be entered in the specified order. If parameters are omitted, they default from the right. The parameter `DEFault` is used as a placeholder.

The following examples use the source list parameter to specify the measurement channel as Channel A. The expected power and resolution parameters are defaulted, leaving them at their current settings.

Although the `READ?` and `FETCh?` queries have three optional parameters, it is not necessary to define them as shown in these examples. If they are defined, they must be identical to those defined in the `CONFiGure` command otherwise an error occurs.

Using `READ?`

<code>ABOR1</code>	Aborts Channel A.
<code>CONF1 DEF,DEF, (@1)</code>	Configures <code>CALCulate1</code> to make a Channel A measurement using the current expected power and resolution settings.
<code>READ1?</code>	Takes the <code>CALCulate1</code> measurement.

Using `INITiate` and `FETCh?`

<code>ABOR1</code>	Aborts Channel A.
<code>CONF1 DEF,DEF, (@1)</code>	Configures <code>CALCulate1</code> to make a Channel A measurement using the current expected power and resolution settings.
<code>INIT1</code>	Causes Channel A to make a measurement.
<code>FETC1? DEF,DEF, (@1)</code>	Retrieves the <code>CALCulate1</code> measurement.

Example 3: Specifying the expected power parameter

The previous example details the three optional parameters which can be used with the `CONFiGure` and `READ?` commands. The first optional parameter is used to enter an expected power value.

The following example uses the expected value parameter to specify a value of -30 dBm. The resolution parameter is defaulted, leaving it at its current setting. The source list parameter specifies a Channel A measurement.

Using READ?

ABOR1	Aborts Channel A.
CONF1 -30,DEF, (@1)	Configures CALCulate1 to make a Channel A measurement using an expected power of -30 dBm and the current resolution setting.
READ1?	Takes the CALCulate1 measurement.

Some fine tuning of measurements can be performed using the CONFigure and READ? commands. For example, in the above program segment, some fine tuning can be performed by setting the filter length to 1024 and the trigger delay off.

```

1 ABOR1
2 CONF1 -30,DEF, (@1)
3 SENS1:AVER:COUN 1024
4 TRIG1:DEL:AUTO OFF
5 READ1?

```

Using INITiate and FETCh?

ABOR1	Aborts Channel A.
CONF1 -30,DEF, (@1)	Configures CALCulate1 to make a Channel A measurement using an expected power of -30 dBm and the current resolution setting.
INIT1	Causes Channel A to make a measurement.
FETC1? -30,DEF, (@1)	Retrieves the CALCulate1 measurement.

Some fine tuning of measurements can be carried out using the CONFigure command and INITiate and FETCh? commands. For example, in the above program segment, some fine tuning can be carried out by setting the filter length to 1024 and the trigger delay off.

```

1 ABOR1
2 CONF1 -30,DEF, (@1)
3 SENS1:AVER:COUN 1024
4 TRIG1:DEL:AUTO OFF
5 INIT1
6 FETC1? -30,DEF, (@1)

```

Example 4: Specifying the resolution parameter

The previous examples detailed the use of the expected value and source list parameters. The resolution parameter is used to set the resolution of the specified `CALCulate` subsystem. This parameter does not affect the resolution of the data; however it does affect the auto-averaging setting (refer to **Figure 1-2**).

The following example uses the resolution parameter to specify a resolution setting of 3. This setting represents three significant digits if the measurement suffix is `W` or `%`, and 0.01 dB if the suffix is `dB` or `dBm` (for further details on the resolution parameter, refer to the commands in **Chapter 12**, "MEASure Subsystem"). Also, in this example, the expected power and source list parameters are defaulted. The expected power value is left unchanged at its current setting. Note that as the source list parameter is the last specified parameter, you do not have to specify `DEF`.

Using READ?

<code>ABOR1</code>	Aborts Channel A.
<code>CONF1 DEF, 3</code>	Configures <code>CALCulate1</code> to make a measurement using the current setting of the expected power and source list and a resolution setting of 3.
<code>READ1?</code>	Takes the <code>CALCulate1</code> measurement.

Some fine tuning of the above program segment can be carried out, for example, by setting the trigger delay off.

```

1 ABOR1
2 CONF1 DEF, 3
3 TRIG1:DEL:AUTO OFF
4 READ1?

```

Using INITiate and FETCh?

<code>ABOR1</code>	Aborts Channel A.
<code>CONF1 DEF, 3</code>	Configures <code>CALCulate1</code> to make a measurement using the current setting of the expected power and source list and a resolution setting of 3.
<code>INIT1</code>	Causes Channel A to make a measurement.
<code>FETC1? DEF, 3</code>	Retrieves the <code>CALCulate1</code> measurement.

Some fine tuning of the above program segment can be carried out, for example, by setting the trigger delay off.

```

1  ABOR1
2  CONF1 DEF, 3
3  TRIG1:DEL:AUTO OFF
4  INIT1:IMM
5  FETC1? DEF, 3

```

Example 5: Making a difference measurement

The following program segment queries the `CALCulate2` subsystem to make a difference measurement of Channel A – Channel A. The expected power level and resolution parameters are defaulted, leaving them at their current settings. Some fine tuning of the measurement is carried out by setting the averaging and setting the trigger delay to off.

Using READ?

```

ABOR1
CONF2:POW:AC:DIFF DEF,DEF, (@1), (@1)
SENS1:AVER:COUN 1024
TRIG1:DEL:AUTO OFF
READ2:POW:AC:DIFF?
READ2:POW:AC:DIFF? DEF,DEF, (@1), (@1)

```

(A second `READ?` query is sent to make a Channel A – Channel A measurement using fresh measurement data).

Using INITiate and FETCh?

```

ABOR1
CONF2:POW:AC:DIFF DEF,DEF, (@1), (@1)
SENS1:AVER:COUN 1024
TRIG1:DEL:AUTO OFF
INIT1:IMM
FETC2:POW:AC:DIFF?
FETC2:POW:AC:DIFF? DEF,DEF, (@1), (@1)

```

(A second `FETCh?` query is sent to make a Channel A – Channel A measurement using the current measurement data).

Example 6: Making a ratio measurement

The following program segment queries the CALCulate2 subsystem to make a ratio measurement of Channel A/A. The expected power level and resolution parameters are defaulted, leaving them at their current settings. Some fine tuning of the measurement is carried out by setting the averaging.

Using READ?

```
ABOR1
CONF2:POW:AC:RAT DEF,DEF,(@1),(@1)
SENS1:AVER:COUN 512
READ2:POW:AC:RAT?
READ2:POW:AC:RAT? DEF,DEF,(@1),(@1)
```

(A second READ? query is sent to make a Channel A/Channel A measurement using fresh measurement data.)

Using INITiate and FETCh?

```
ABOR1
CONF2:POW:AC:RAT DEF,DEF,(@1),(@1)
SENS1:AVER:COUN 512
INIT1:IMM
FETC2:POW:AC:RAT?
FETC2:POW:AC:RAT? DEF,DEF,(@1),(@1)
```

(A second FETCh? query is sent to make a Channel A/Channel A measurement using the current measurement data.)

Using the lower-level commands

An alternative method of making measurements is to use the lower-level commands to set the measurement type. This can be done using the following commands:

```
CALCulate[1] | 2 | 3 | 4 : MATH [ : EXPRESSION ]
CALCulate[1] | 2 | 3 | 4 : RELative [ : MAGNitude ] : AUTO
```

The advantage of using the lower-level commands over the `CONFigure` command is that they give you more precise control of the U2040 X-Series. As shown in **Table 1-1**, the `CONFigure` command presets various states in the U2040 X-Series. It may be likely that you do not want to preset these states.

Example

The following example sets the single Channel A measurement on the `CALCulate2` subsystem.

<code>ABOR1</code>	Aborts Channel A.
<code>CALC2:MATH:EXPR "(SENS1)"</code>	Sets <code>CALCulate2</code> to a single measurement.
<code>INIT1</code>	Causes Channel A to make a measurement.
<code>FETC2?</code>	Retrieves the <code>CALCulate2</code> measurement.

Using Frequency-Dependent Offset Tables

This section describes how to use frequency-dependent offset tables. These tables give you the ability to compensate for frequency effects in your test setup.

Overview

If the `[:SENSe[1] :]CORRection:CSET2:STATe` command is OFF, the frequency-dependent offset tables are not used. When `[:SENSe[1] :]CORRection:CSET2:STATe` is ON, the frequency-dependent offset tables are used, providing you with a quick and convenient method of compensating for your external test setup over a range of frequencies. Note that when selected, frequency-dependent offset correction is IN ADDITION to any correction applied for sensor frequency response. The U2040 X-Series is capable of storing 10 frequency-dependent offset tables of 512 frequency points each.

To use frequency-dependent offset tables, you:

- 1 Edit a frequency-dependent offset table if necessary.
- 2 Select the frequency-dependent offset table.
- 3 Enable the frequency-dependent offset table.
- 4 Zero and calibrate the U2040 X-Series.
- 5 Specify the frequency of the signal you want to measure. The required offset is automatically set by the U2040 X-Series from the frequency-dependent offset table.
- 6 Make the measurement.

Figure 1-1 illustrates how frequency-dependent offset tables operate.

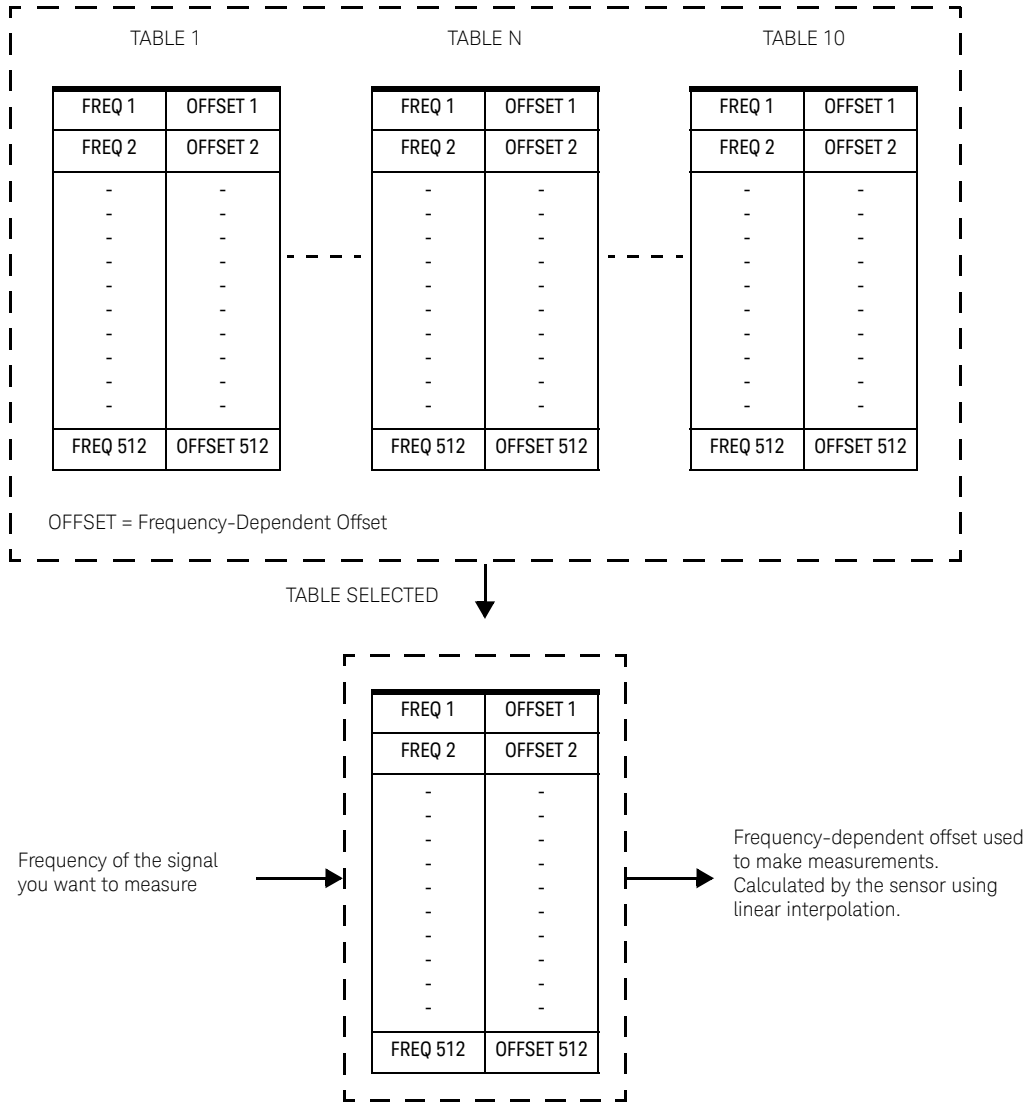

Figure 1-1 Frequency-dependent offset tables

Editing frequency-dependent offset tables

It is not possible to create any additional frequency-dependent offset tables. However, the 10 existing tables can be edited using the `MEMory` subsystem. To do this:

- 1 Select one of the existing tables using:

```
MEMory:TABLE:SElect <string>
```

 For information on naming frequency-dependent offset tables, see “**Naming frequency-dependent offset tables**” on page 41. For information on the current names you can select, refer to “**Listing the frequency-dependent offset table names**” on page 40.
- 2 Enter the frequency data using:

```
MEMory:TABLE:FREquency <numeric_value>{,<numeric_value>}
```
- 3 Enter the offset factors as shown in the table below using:

```
MEMory:TABLE:GAIN <numeric_value>{,<numeric_value>}
```

Frequency	Offset
Frequency 1	Offset 1
Frequency 2	Offset 2
“	“
Frequency n	Offset n

- 4 If required, rename the frequency-dependent offset table using `MEMory:TABLE:MOVE <string>,<string>`. The first `<string>` parameter identifies the existing table name, and the second identifies the new table name.

NOTE

- The legal frequency suffix multipliers are any of the IEEE suffix multipliers, for example, KHZ, MHZ, and GHZ. If no units are specified, the data is assumed as Hz.
- PCT is the only legal unit for offset factors and can be omitted.
- The frequency and offset data must be within range. Refer to the individual commands in **Chapter 5**, "CALibration Subsystem" for their specified ranges.
- Any offset values entered into the table should exclude the effect of the U2040 X-Series.
- Characterization of the test setup independently of the U2040 X-Series allows the same table to be used with any sensor.
- Ensure that the frequency points you use cover the frequency range of the signals you want to measure. If you measure a signal with a frequency outside the frequency range defined in the frequency-dependent offset table, then the U2040 X-Series uses the highest or lowest frequency point in the table to calculate the offset.
- To make subsequent editing of a frequency-dependent offset table simpler, it is recommended that you retain a copy of your data in a program.

Listing the frequency-dependent offset table names

To list the frequency-dependent offset tables currently stored in the U2040 X-Series, use the following query:

```
MEMory:CATalog:TABLE?
```

The U2040 X-Series returns the data in the form of two numeric parameters and a string list representing all stored tables.

```
<numeric_value>,<numeric_value>{,<string>}
```

The first numeric parameter indicates the amount of memory, in bytes, used for storage of tables. The second parameter indicates the memory, in bytes, available for tables.

Each string parameter returned indicates the name, type, and size of a stored frequency-dependent offset table:

```
<string>,<type>,<size>
```

<string>, <type>, and <size> are all character data. <type> is always `TABL`, <size> is displayed in bytes.

For example, a sample of the response may look like:

```
560,8020,"Offset_1,TABL,220","Offset_2,TABL,340" ...
```

Naming frequency-dependent offset tables

To rename a frequency-dependent offset table, use:

```
MEMory:TABLE:MOVE <string>,<string>
```

The first <string> parameter identifies the existing table name, and the second identifies the new table name.

The following rules apply to frequency-dependent offset table names:

- 1 Table names use a maximum of 12 characters.
- 2 All characters must be upper- or lower-case alphabetic characters, or numeric (0-9), or an underscore (_).

No spaces are allowed in the name.

Reviewing table data

To review the data stored in a frequency-dependent offset table, use the following commands:

```
MEMory:TABLE:SElect "Offset1"
```

Select the frequency-dependent offset table named "Offset1".

```
MEMory:TABLE:SElect?
```

Query which returns the name of the currently selected table.

```
MEMory:TABLE:FREQuency:POINts?
```

Query which returns the number of stored frequency points.

```
MEMory:TABLE:FREQuency?
```

Query which returns the frequencies stored in the frequency-dependent offset table (in Hz).

```
MEMory:TABLE:GAIN[:MAGNitude]:POINts?
```

Query which returns the number of offset factor points stored in the frequency-dependent offset table.

```
MEMory:TABLE:GAIN[:MAGNitude]?
```

Query which returns the offset factors stored in the frequency-dependent offset table.

Modifying data

If you need to modify the frequency and offset factor data stored in a frequency-dependent offset table, you need to resend the complete data lists.

If you have retained the original data in a program, edit the program and resend the data.

Selecting a frequency-dependent offset table

After you have created the frequency-dependent offset table, you can select it using the following command:

```
[ :SENSe[1]: ]CORRection:CSET2[:SElect] <string>
```

To find out which frequency-dependent offset table is currently selected, use the query:

```
[ :SENSe[1]: ]CORRection:CSET2[:SElect]?
```

Enabling a frequency-dependent offset table

To enable the frequency-dependent offset table, use the following command:

```
[ :SENSe[1]: ]CORRection:CSET2:STATe ON
```

If you set `[:SENSe[1]:]CORRection:CSET2:STATe` to ON and no frequency-dependent offset table is selected, error -221, "Settings conflict" occurs.

Making the measurement

To make the power measurement, set the U2040 X-Series for the frequency of the signal you want to measure. The U2040 X-Series automatically sets the offset factor. Use either `INITiate`, `FETCh?`, or `READ?` to initiate the measurement as shown in the following program segments:

INITiate example

```
ABORt1
CONFIgure1:POWer:AC DEF,1,(@1)
SENS1:CORR:CSET2:SEL "Offset1"
SENS1:CORR:CSET2:STAT ON
SENS1:FREQuency 500MHZ
INITiate1:IMMediate
FETCh1?
```

READ? Example

```
ABORt1
CONFigure1:POWer:AC DEF,2,(@1)
SENS1:CORR:CSET2:SEL "Offset1"
SENS1:CORR:CSET2:STAT ON
SENS1:FREQuency 500MHZ
READ1?
```

NOTE

- If the measurement frequency does not correspond directly to a frequency in the frequency-dependent offset table, the U2040 X-Series calculates the offset using linear interpolation.
 - If you enter a frequency outside the frequency range defined in the frequency-dependent offset table, then the U2040 X-Series uses the highest or lowest frequency point in the table to set the offset.
 - To find out the value of the offset being used by the U2040 X-Series to make a measurement, use the
[:SENSe[1]:]CORRection:FDOffset|GAIN4[:INPut][:MAGNitude]?
query. The response may be an interpolated value.
-

Setting the Averaging

This section provides an overview of setting the averaging. For more detailed information, refer to the individual commands in **Chapter 16**, "SENSe Subsystem".

Averaging

The U2040 X-Series has a digital filter to average power readings. The number of readings averaged can range from 1 to 1024. This filter is used to reduce noise, to obtain the desired resolution, and to reduce the jitter in the measurement results. However, the time to take the measurement is increased. You can select the filter length or you can set the U2040 X-Series to the auto-filter mode. To enable and disable averaging, use the following command:

```
[ :SENSe[1] : ]AVERAge [ :STATe ] <boolean>
```

Auto-averaging mode

To enable and disable the auto-filter mode, use the following command:

```
[ :SENSe[1] : ]AVERAge:COUNT:AUTO <boolean>
```

When the auto-filter mode is enabled, the U2040 X-Series automatically sets the number of readings averaged together to satisfy the filtering requirements for most power measurements. The number of readings averaged together depends on the resolution and the power level currently being measured. **Figure 1-2** shows the typical number of averages for each range and resolution when the U2040 X-Series is in the auto-filter mode and set to the normal speed mode.

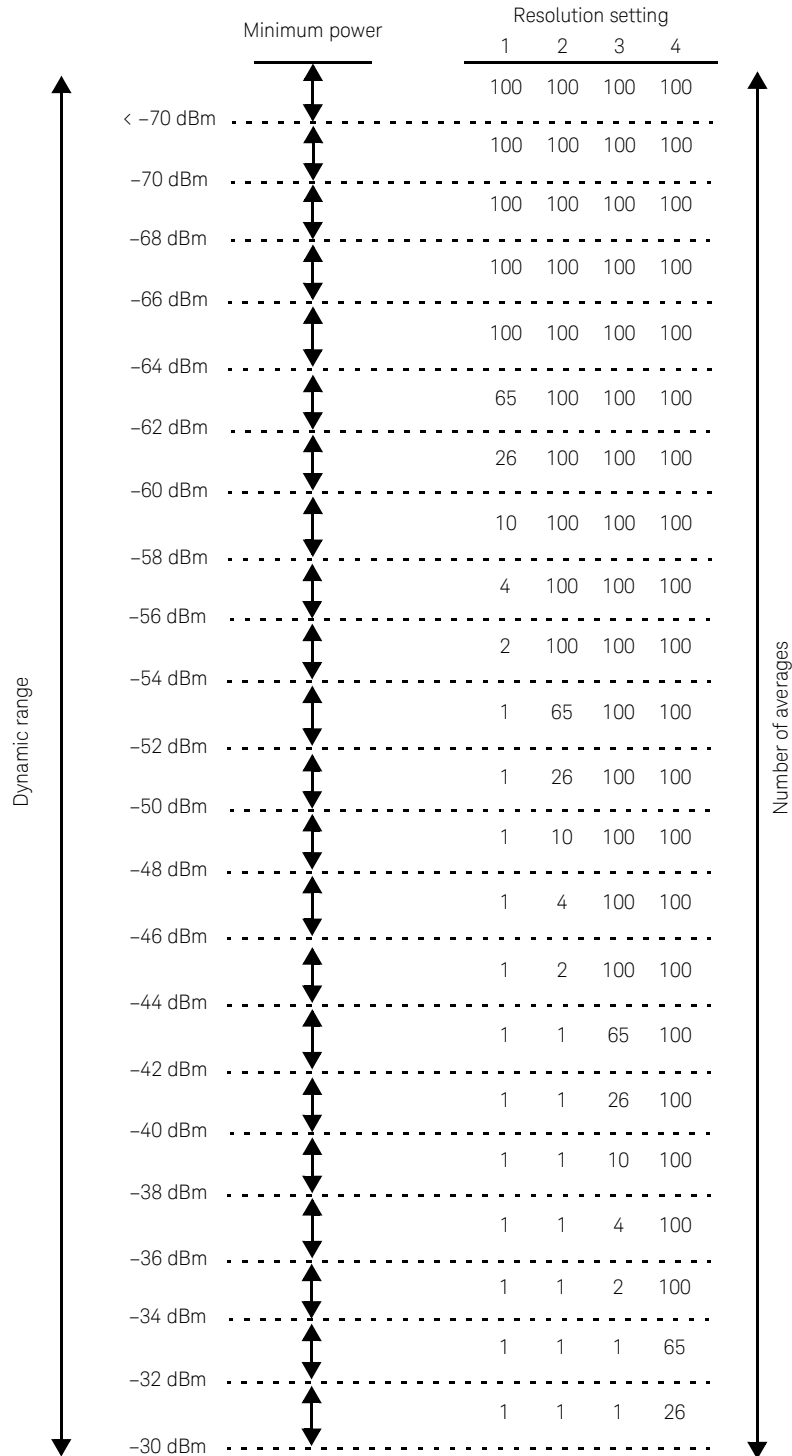
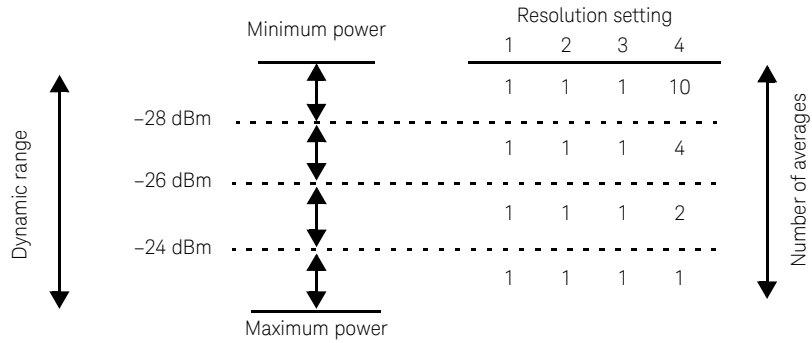

Figure 1-2 Typical averaged readings



The four resolution levels represent:

- 1, 0.1, 0.01, 0.001 dB respectively if the measurement suffix is dBm or dB.
- 1, 2, 3, or 4 significant digits respectively if the measurement suffix is W or %.

Figure 1-3 Typical averaged readings (continued)

Figure 1-4 illustrates part of the U2040 X-Series dynamic range hysteresis.

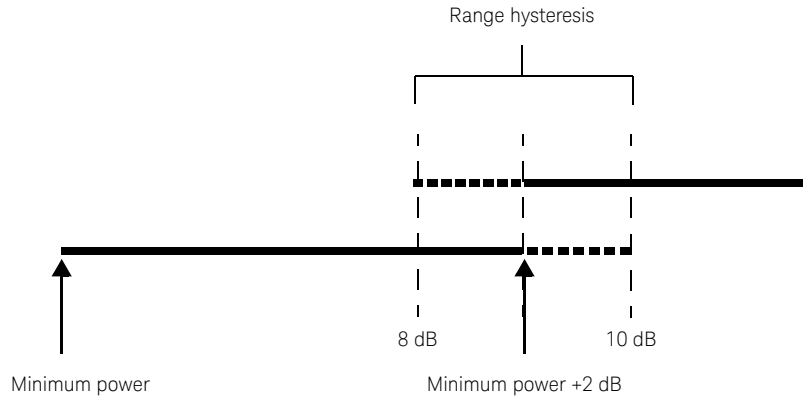

Figure 1-4 Dynamic range hysteresis

Filter length

You can specify the filter length using the following command:

```
[[:SENSE[1]:]AVERAge:COUNT <numeric_value>
```

The range of values for the filter length is 1 to 1024. Specifying this command disables automatic filter length selection. Increasing the value of the filter length reduces measurement noise. However, the time to take the measurement is increased.

Setting Offsets

Channel offsets

The U2040 X-Series can be configured to compensate for signal loss or gain in your test setup (for example, to compensate for the loss of a 10 dB attenuator). You use the `SENSE` command subsystem to configure the U2040 X-Series. Gain and loss corrections are a coupled system. If you enter an offset value, the state is automatically enabled. However, it can be enabled and disabled using the `[:SENSE[1]:]CORREction:GAIN2:STATE <boolean>` and `[:SENSE[1]:]CORREction:LOSS2:STATE <boolean>` commands.

CALCulate offsets

CALCulate offset values can be entered using the

`CALCulate[1] | 2 | 3 | 4 :GAIN[:MAGNitude]` command.

`CALCulate[1] | 2 | 3 | 4 :GAIN:STATE` must be set to ON to enable the offset value. If you enter an offset value, the state is automatically enabled. This offset is applied after any math calculations (refer to **Figure 1-6**).

Example

The following command sequence details how to use the channel and CALCulate offsets to make a Channel A/A ratio measurement.

The final result is:

$$\left(\left(\frac{A_{dBm} - 10}{A_{dBm} - 10} \right) - 20 \right)_{dB}$$

Send device clear	Clears the U2040 X-Series interface.
*RST	Sets the U2040 X-Series to a known state.
CONF:POW:AC:RAT 20DBM,2,(@1),(@1)	Configures the U2040 X-Series to make the measurement.
UNIT:POW DBM	Sets the measurement unit to dBm.
SENS:CORR:GAIN2 -10	Sets the channel offset to -10 dB.
SENS:CORR:GAIN2:STAT ON	Enables the gain correction.
CALC1:GAIN -20DB	Sets the CALCulate offset to -20 dB.
INIT1:IMM	Initiates the measurement.
FETC:POW:AC:RAT? 20DBM,2,(@1),(@1)	Retrieves the result.

For further information on channel offsets, refer to “**SENSe Subsystem**” on page 207. For further information on CALCulate offsets, refer to “**CALCulate Subsystem**” on page 89.

Setting Measurement Limits

You can configure the U2040 X-Series to detect when a measurement is outside of a predefined upper and/or lower limit value. Limits can be applied to power, ratio, or difference measurements.

Setting limits

The U2040 X-Series can be configured to verify the power being measured against an upper and/or lower limit value. The range of values that can be set for lower and upper limits is -150.00 dBm to $+230.00$ dBm. The default upper limit is $+90.00$ dBm and the default lower limit is -90.00 dBm.

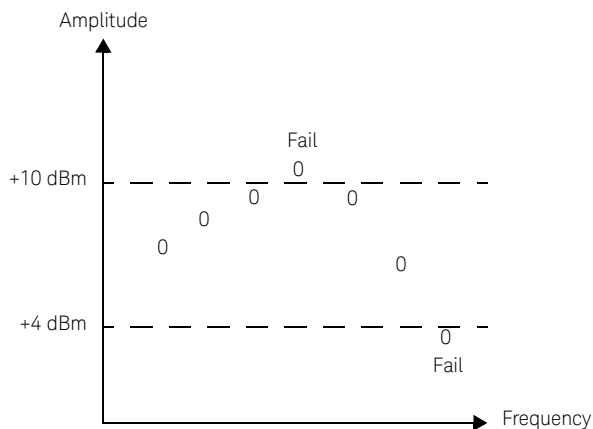

Figure 1-5 Limits checking results

The range of values that can be set for the upper and lower limits and the default values depend on the measurement units in the current measurement line. Refer to **Table 1-2**.

Table 1-2 Range of values for limits

Units	Maximum	Minimum	Default maximum	Default minimum
dB	+200 dB	-180 dB	60 dB	-120 dB
dBm	+230 dBm	-150 dBm	90 dBm	-90 dBm
%	10.0 Z%	100.0 a%	100.0 M%	100.0 p%
W	100.000 EW	1.000 aW	1.000 MW	1.000 pW

Checking for limit failures

There are two ways to check for limit failures:

- Use the `CALCulate[1]|2|3|4:LIMit:FAIL?` and `CALCulate[1]|2|3|4:LIMit:FCOunt?` queries for limits.
- Use the `STATus` command subsystem.

NOTE

If `TRIGger:DElay:AUTO` is set to `ON`, then the number of failures returned by `CALCulate[1]|2|3|4:LIMit:FCOunt?` is affected by the current filter settings.

Getting the Best Speed Performance

This section discusses the factors that influence the speed of operation (number of readings/sec) of the U2040 X-Series.

The following factors are those which have the greatest effect upon measurement speed (in no particular order):

- The selected measurement rate (NORMal, DOUBle, FAST).
- The trigger mode (for example, free run, trigger with delay, etc.).
- The output format (ASCIi or REAL).
- The units used for the measurement.
- The command used to take a measurement.
- The aperture size (SENS:SWE:APER) in the AVERage path.

In addition, there are other influences in the FAST mode which are described in “**Fast mode**” on page 53.

The following paragraphs give a brief description of the above factors and how they are controlled from SCPI.

Measurement rate

There are three possible speed settings: NORMal, DOUBle, and FAST. These are set using the [:SENSE[1]:]MRATE command.

In the NORMal and DOUBle modes, full instrument functionality is available, but in the FAST mode, limits and ratio/difference math functions are disabled.

Refer to the specifications in the *U2040 X-Series User's Guide* to determine the influence of these speed settings on the accuracy and noise performance of the U2040 X-Series.

Trigger mode

The U2040 X-Series has a very flexible triggering system. For simplicity, it can be described as having three modes:

- Free Run: When the U2040 X-Series is in the Free Run mode, it continuously takes measurements. A measurement is in free run when INITiate:CONTinuous is set to ON and TRIGger:SOURce is set to IMMEDIATE.
- Triggered Free Run: When the U2040 X-Series is in the Triggered Free Run or Continuous Trigger mode, it takes a new measurement each time a trigger event is detected. A measurement is in triggered free run or continuous trigger when INITiate:CONTinuous is set to ON and TRIGger:SOURce is not set to IMMEDIATE.

- Single Shot: When the U2040 X-Series is in the Single Shot mode, it takes a new measurement when a trigger event is detected and then returns to the idle state. A measurement is in single shot when `INITiate:CONTinuous` is set to `OFF`. Note that a measurement can take several `INT/EXT` triggers depending on the filter settings. Refer to “**TRIGger[1][:SEQUence[1]]:DELay:AUTO**” on page 436 for further information.

NOTE

A trigger event can be any of the following:

- The input signal meeting the trigger level criteria.
- Auto-level triggering being used.
- A `TRIGger[1][:IMMediate]` or `*TRG` command being sent.
- An external TTL level trigger being detected.

Trigger with delay

This can be achieved using the same sequences above (apart from the second) with `TRIG:DEL:AUTO` set to `ON`. Also, the `MEAS?` query operates in the trigger with delay mode.

In the trigger with delay mode, a measurement is not completed until the U2040 X-Series filter is full. In this way, the reading returned is guaranteed to be settled. In all other modes, the result returned is simply the current result from the filter and may or may not be settled. This depends on the current length of the filter and the number of readings that have been taken since a change in power level.

When trigger with delay is enabled, the measurement speed for average path in single trigger mode can be approximately calculated using the following equation:

$$\text{readings/sec} = 1/[(\text{aperture duration} * \text{filter length}) + \text{IO processing time}]$$

where the IO processing time is approximately 3 ms and can vary slightly depending on the speed of the controller used to retrieve results from the U2040 X-Series.

NOTE

The equation above only applies for aperture of 500 μs and above.

Typically, the free run mode provides the best speed performance from the U2040 X-Series (especially in the `FAST` mode).

Output format

The U2040 X-Series has two output formats for measurement results: `ASCIi` and `REAL`. These formats are selected using the `FORMat` command. When `FORMat` is set to `REAL`, the returned result is in the IEEE 754 floating-point format (note that the byte order can be changed using `FORMat:BOReR`) plus `<LF>` as an end sentinel of the block.

The `REAL` format is likely to be required only for the `FAST` mode as it reduces the amount of bus traffic.

Units

The U2040 X-Series can output results in either linear or log units. The internal units are linear, therefore optimal performance is achieved when the results output are also in linear units (since the overhead of performing a log function is removed).

Command used

In the Free Run mode, `FETCh?` must be used to return a result.

In other trigger modes, there are a number of queries that can be used, for example, `MEASure?`, `READ?`, and `FETCh?`. Note that the `MEAS?` and `READ?` queries are compound commands – they perform a combination of other lower-level commands. Typically, the best speed performance is achieved using the low-level commands directly.

Trigger count

To get the fastest measurement speed, `TRIG:COUnT` must be set to return multiple measurements for each `FETCh?` query. In the normal mode (peak measurements), a count of 50 is required to attain 3500 or more readings per second.

Fast mode

In the highest speed setting, the limiting factor tends to be the speed of the controller being used to retrieve results from the U2040 X-Series, and to a certain extent, the volume of remote traffic. The latter can be reduced using the `FORMat REAL` command to return results in the binary format. The former is a combination of two factors:

- the hardware platform being used
- the programming environment being used

How Measurements are Calculated

Figure 1-6 details how measurements are calculated. It shows the order in which the various U2040 X-Series functions are implemented in the measurement calculation.

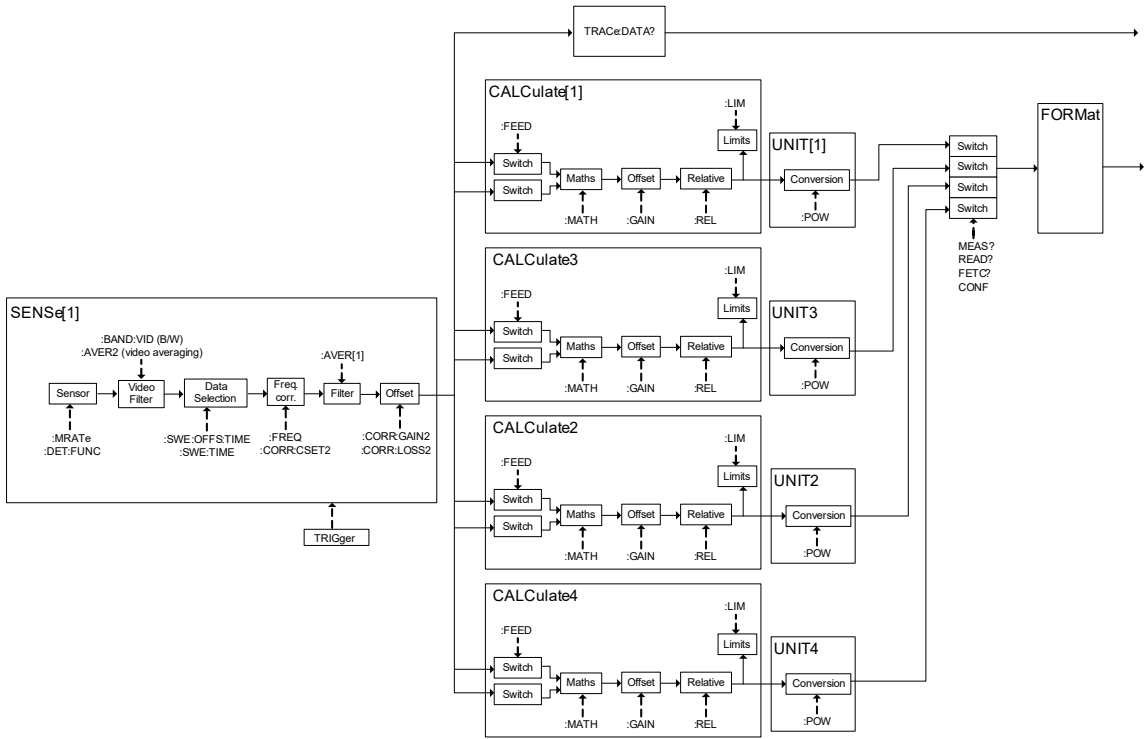

Figure 1-6 How measurements are calculated

The MEASure query in this figure can be replaced with FETCh? and READ?.

Status Reporting

Status reporting is used to monitor the U2040 X-Series to determine when events have occurred. Status reporting is accomplished by configuring and reading status registers.

The U2040 X-Series has the following main registers:

- Status Register
- Standard Event Register
- Operation Status Register
- Questionable Status Register
- Device Status Register

There are other registers that exist “behind” the main registers, and are described later in this chapter.

Status and Standard Event registers are read using the IEEE-488.2 common commands.

Operation and Questionable Status registers are read using the SCPI `STATUS` command subsystem.

The general status register model

The generalized status register model shown in **Figure 1-7** is the building block of the SCPI status system. This model consists of a condition register, a transition filter, an event register, and an enable register. A set of these registers is called a status group.

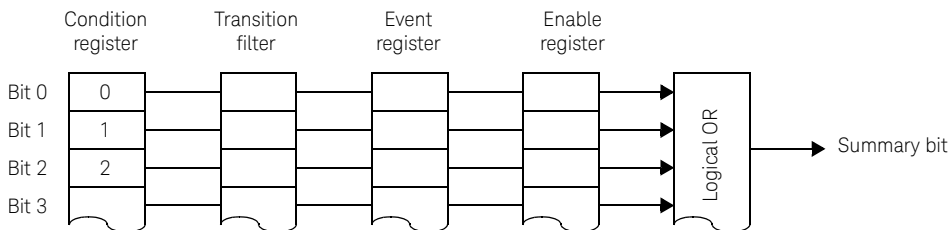

Figure 1-7 Generalized status register model

When a status group is implemented in an instrument, it always contains all of the component registers. However, there is not always a corresponding command to read or write to every register.

Condition register

The condition register continuously monitors the hardware and firmware status of the U2040 X-Series. There is no latching or buffering for this register, it is updated in real time. Condition registers are read-only.

Transition filter

The transition filter specifies which type of bit state changes in the condition registers and sets corresponding bits in the event register. Transition filter bits may be set for positive transitions (PTR), negative transitions (NTR), or both. Transition filters are read-write. They are unaffected by *CLS or queries. After STATUS:PRESet, the NTR register is set to 0 and all bits of the PTR are set to 1.

Event register

The event register latches transition events from the condition register as specified by the transition filter. Bits in the event register are latched and on setting, they remain set until cleared by a query or a *CLS. Also on setting, an event bit is no longer affected by condition changes. It remains set until the event register is cleared; either when you read the register or when you send the *CLS (clear status) command. Event registers are read-only.

Enable register

The enable register specifies the bits in the event register that can generate a summary bit. The instrument logically ANDs corresponding bits in the event and enable registers and ORs all the resulting bits to obtain a summary bit. Enable registers are read-write. Querying an enable register does not affect it.

An example sequence

Figure 1-8 illustrates the response of a single bit position in a typical status group for various settings. The changing state of the condition in question is shown at the bottom of the figure. A small binary table shows the state of the chosen bit in each status register at the selected times T1 to T5.

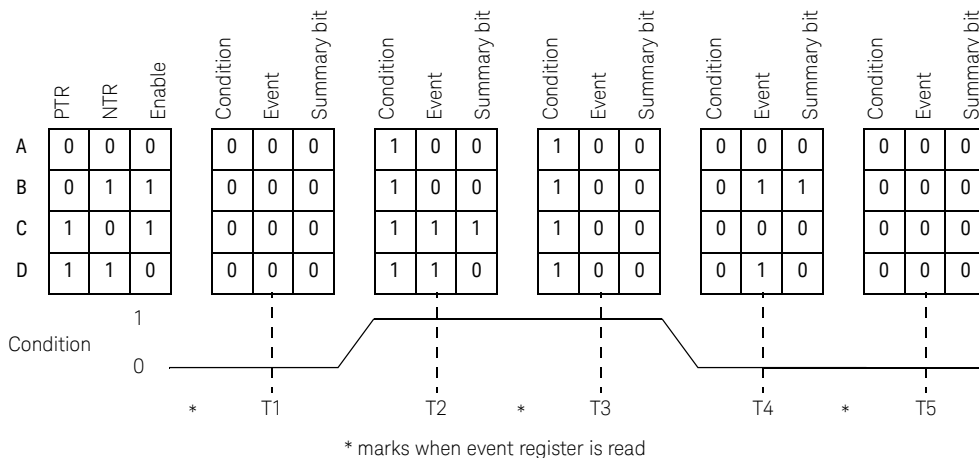

Figure 1-8 Typical status register bit changes

How to use registers

Use the polling method to access the information in status groups. In this polling method, the U2040 X-Series has a passive role. It only informs the controller that conditions have changed when the controller asks. When you monitor a condition with the polling method, you must:

- 1 Determine which register contains the bit that monitors the condition.
- 2 Send the unique query that reads that register.
- 3 Examine the bit to see if the condition has changed.

Status registers

The Status system in the U2040 X-Series is shown in **Figure 1-9**. The Operation Status and Questionable Status groups are 16 bits wide, while the Status Byte and Standard Event groups are 8 bits wide. In all 16-bit groups, the most significant bit (bit 15) is not used and is always set to 0.

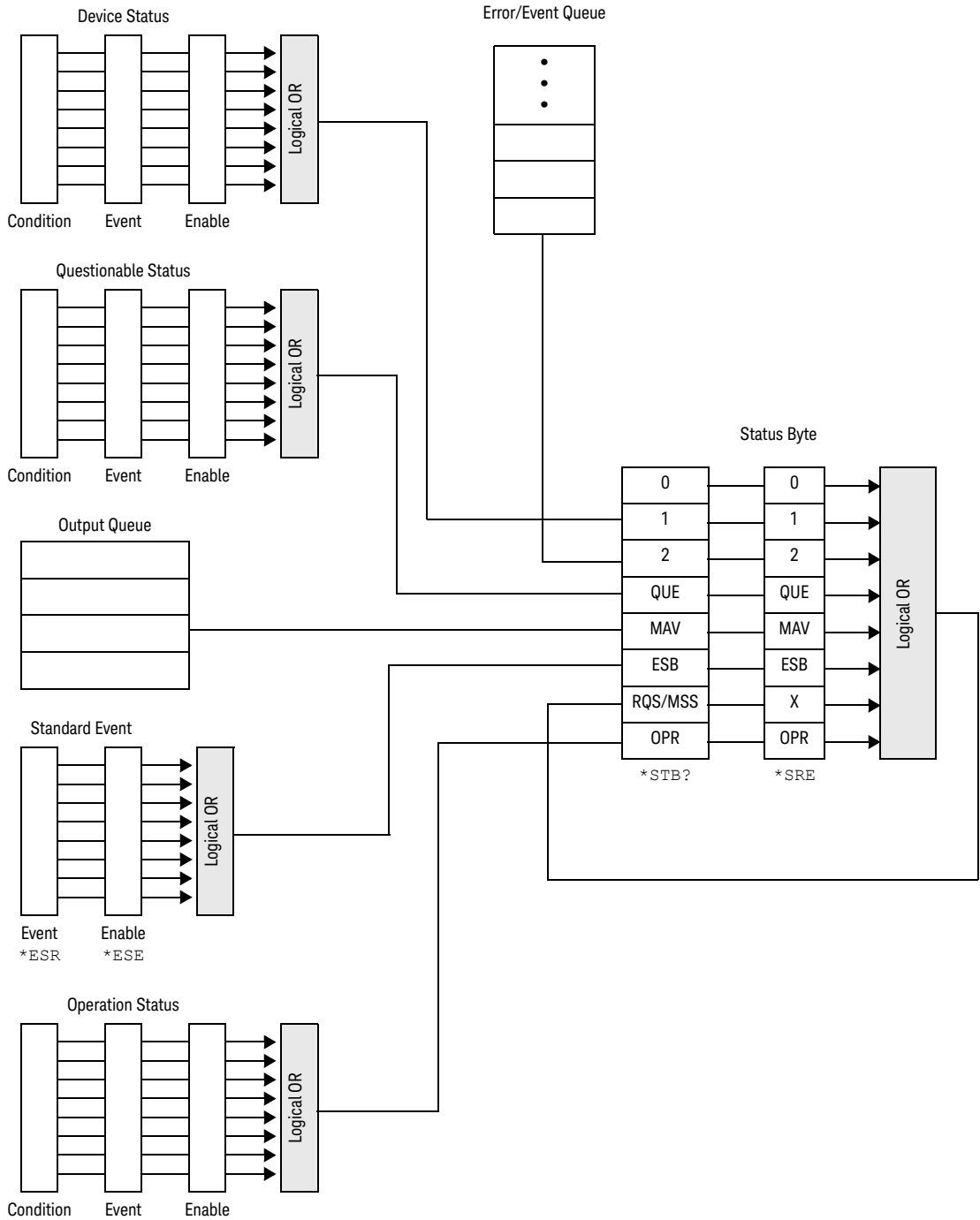

Figure 1-9 Status system

The Status Byte summary register

The status byte summary register reports conditions from other status registers. Query data waiting in the U2040 X-Series output buffer is immediately reported through the “message available” bit (bit 4). Clearing an event register clears the corresponding bits in the status byte summary register. Reading all messages in the output buffer, including any pending queries, clears the message available bit.

Table 1-3 Bit definitions - Status byte register

Bit number	Decimal weight	Definition
0	1	Not Used (Always set to 0)
1	2	Device Status Register summary bit. One or more bits are set in the Device Status Register (bits must be “enabled” in the enable register)
2	4	Error/Event Queue
3	8	Questionable Status Register summary bit. One or more bits are set in the Questionable Status Register (bits must be “enabled” in the enable register).
4	16	Data Available Data is available in the output buffer.
5	32	Standard Event One or more bits are set in the Standard Event register (bits must be “enabled” in the enable register).
6	64	Request Service The U2040 X-Series is requesting service (serial poll).
7	128	Operation Status Register summary bit. One or more bits are set in the Operation Status Register (bits must be “enabled” in the enable register).

Particular bits in the status byte register are cleared when:

- The standard event, questionable status, operation status, and device status are queried.
- The error/event queue becomes empty.
- The output queue becomes empty.

The status byte enable register (SRE, service request enable) is cleared when you:

- cycle the U2040 X-Series power.
- execute a `*SRE 0` command.

Using `*STB?` to read the status byte

The `*STB?` (status byte query) command is similar to a serial poll except it is processed like any other U2040 X-Series command. `*STB?` returns the same result as an IEEE-488 serial poll except that the request service bit (bit 6) is not cleared if a serial poll has occurred. `*STB?` is not handled automatically by the IEEE-488 bus interface hardware and the command is executed only after previous commands have completed. Using `*STB?` does not clear the status byte summary register.

The Standard Event register

The standard event register reports the following types of instrument events: power-on detected, command and syntax errors, command execution errors, self-test or calibration errors, query errors, or when an overlapped command completes following an *OPC command. Any or all of these conditions can be reported in the standard event summary bit through the enable register. You must write a decimal value using the *ESE (event status enable) command to set the enable register mask.

Table 1-4 Bit definitions - Standard event register

Bit number	Decimal value	Definition
0	1	Operation Complete All overlapped commands following an *OPC command have been completed.
1	2	Not Used. (Always set to 0.)
2	4	Query Error A query error occurred, refer to error numbers 410 to 440 in "Error message" on page 340.
3	8	Device-Dependent Error A device error occurred, refer to error numbers 310 to 350 in "Error message" on page 340.
4	16	Execution Error An execution error occurred, refer to error numbers 211 to 241 in "Error message" on page 340.
5	32	Command Error A command syntax error occurred, refer to error numbers 101 to 178 in "Error message" on page 340.
6	64	User Request
7	128	Power On Power has been turned off and on since the last time the event register was read or cleared.

The standard event register is cleared when you:

- send a *CLS (clear status) command.
- query the event register using the *ESR? (event status register) query.

The standard event enable register is cleared when you:

- cycle the U2040 X-Series power.
- execute a *ESE 0 command.

Questionable Status register

The questionable status register provides information about the quality of the U2040 X-Series measurement results. Any or all of these conditions can be reported in the questionable data summary bit through the enable register. You must write a value using the `STATUS:QUESTIONABLE:ENABLE` command to set the enable register mask.

The following bits in these registers are used by the U2040 X-Series.

Table 1-5 Bit definitions - Questionable status registers

Bit number	Decimal weight	Definition
0 to 2	-	Not used
3	8	POWER Summary
4 to 7	-	Not used
8	256	CALibration Summary
9	512	Power-On Self-Test
10 to 14	-	Not used
15	-	Not used (always 0)

The condition bits are set and cleared under the following conditions:

Table 1-6 Bit change conditions for questionable status register

Bit number	Meaning	EVENTs causing bit changes
3	POWER Summary	<p>This is a summary bit for the Questionable POWER Register.</p> <ul style="list-style-type: none"> - SET: <ul style="list-style-type: none"> Error -230, "Data corrupt or stale" Error -231, "Data questionable;Input Overload" Error -231, "Data questionable;CALC1 log error" Error -231, "Data questionable;CALC2 log error" Error -231, "Data questionable;CALC3 log error" Error -231, "Data questionable;CALC4 log error" - CLEARED: When no errors are detected by the U2040 X-Series during a measurement covering the causes given for it to set.
8	CALibration Summary	<p>This is a summary bit for the Questionable CALibration Register.</p> <ul style="list-style-type: none"> - SET: <ul style="list-style-type: none"> These may be caused by <code>CALibration[1]:ZERO:AUTO ONCE</code> or <code>CALibration[1]:AUTO ONCE</code> or <code>CALibration[1][:ALL]</code> or <code>CALibration[1][:ALL]?</code>. Error -231, "Data questionable;ZERO ERROR" Error -231, "Data questionable;CAL ERROR" - CLEARED: When any of the commands listed above succeed and no errors are placed on the error queue.
9	Power-On Self-Test	<ul style="list-style-type: none"> - SET: This bit is set when the power-on self-test fails. - CLEARED: When the power-on self-test passes.

Operation status

The operation status group monitors conditions in the U2040 X-Series measurement process.

The following bits in these registers are used by the U2040 X-Series:

Table 1-7 Bit definitions - Operation status

Bit number	Decimal weight	Definition
0	1	CALibrating Summary
1	2	Self-Test Started
2 to 3	-	Not used
4	16	MEASuring Summary
5	32	Waiting for TRIGger Summary
6 to 9	-	Not used
10	1024	SENSe Summary
11	2048	Lower Limit Fail Summary
12	4096	Upper Limit Fail Summary
13 to 14	-	Not used
15	-	Not used (always 0)

The condition bits are set and cleared under the following conditions:

Table 1-8 Bit change conditions for operation status

Bit number	Meaning	EVENTs causing bit changes
0	CALibrating	<p>This is a summary bit for the Operation CALibrating Register.</p> <ul style="list-style-type: none"> - SET: At beginning of zeroing (CALibration:ZERO:AUTO ONCE) and at the beginning of calibration (CALibration:AUTO ONCE). Also for the compound command/query CALibration[:ALL]?, this bit is set when zeroing begins. - CLEARED: At the end of zeroing or calibration.
1	Self-Test Started	<ul style="list-style-type: none"> - SET: At the beginning of the peak linearity test (SERVICE:BIST:PEAK:LINEarity) and at the beginning of zero set and noise test (SERVICE:BIST:PEAK:ZSET). - CLEARED: At the end of each test.
4	MEASuring	<p>This is a summary bit for the Operation MEASuring Register.</p> <ul style="list-style-type: none"> - SET: When the U2040 X-Series is taking a measurement. - CLEARED: When the measurement is completed.
5	Waiting for TRIGger	<p>This is a summary bit for the Operation TRIGger Register.</p> <ul style="list-style-type: none"> - SET: When the U2040 X-Series enters the "wait for trigger" state. - CLEARED: When the U2040 X-Series enters the "idle" state.
10	SENSe	<p>This is a summary bit for the Operation SENSe Register.</p> <ul style="list-style-type: none"> - SET: When the U2040 X-Series is reading data from EEPROM. - CLEARED: When the U2040 X-Series is not reading data from EEPROM.

Table 1-8 Bit change conditions for operation status (continued)

Bit number	Meaning	EVENTs causing bit changes
11	Lower Limit Fail	This is a summary bit for the Lower Limit Fail Register. <ul style="list-style-type: none"> - SET: If a measurement is made and the lower limit test fails. - CLEARED: If a measurement is made and the lower limit test is not enabled or the test is enabled and passes.
12	Upper Limit Fail	This is a summary bit for the Upper Limit Fail Register. <ul style="list-style-type: none"> - SET: If a measurement is made and the upper limit test fails. - CLEARED: If a measurement is made and the upper limit test is not enabled or the test is enabled and passes.

Device Status register

The device status register set contains bits which give device-dependent information.

The following bit in these registers is used by the U2040 X-Series:

Table 1-9 Bit definitions - Device status register

Bit number	Decimal weight	Definition
0 to 2	-	Not used
3	8	Sensor error
4 to 14	-	Not used
15	-	Not used (always 0)

The condition bit is set and cleared under the following conditions:

Table 1-10 Bit change conditions for device status register

Bit number	Meaning	EVENTs causing bit changes
3	Sensor error	<ul style="list-style-type: none"> - SET: If the EEPROM has failed - CLEARED: In every other condition

Using the Operation Complete commands

The *OPC? and *OPC commands allow you to maintain synchronization between the computer and the U2040 X-Series. The *OPC? query places an ASCII character 1 into the U2040 X-Series output queue when all pending commands are completed. If your program reads this response before continuing program execution, you can ensure synchronization between one or more instruments and the computer.

The *OPC command sets bit 0 (Operation Complete) in the standard event status register when all pending U2040 X-Series operations are completed.

Procedure

- 1 Send a device clear message to clear the U2040 X-Series output buffer.
- 2 Clear the event registers with the *CLS (clear status) command.
- 3 Enable operation complete using the *ESE 1 command (standard event register).
- 4 Send the *OPC? (operation complete query) command and enter the result to assure synchronization.
- 5 Send your programming command string, and place the *OPC (operation complete) command as the last command.
- 6 Send the *STB? (status byte query) command to poll the register. This command does not clear the status byte summary register.

Examples

This example program uses the *OPC? command to determine when the U2040 X-Series has finished calibrating.

```
CAL:AUTO ONCE
*OPC?
MEAS:POW:AC?
```

Saving and Recalling U2040 X-Series Configurations

To reduce repeated programming, up to 10 U2040 X-Series configurations can be stored in the U2040 X-Series non-volatile memory. The error list, remote addresses, frequency-dependent offset table data, and zeroing/calibration information are not stored.

How to save and recall a configuration

U2040 X-Series configurations are saved and recalled with the following commands:

```
*SAV <NRf>
```

```
*RCL <NRf>
```

The range of values for <NRf> in the above commands is 1 to 10.

Using Device Clear to Halt Measurements

Device clear is an IEEE-488 low-level bus message which can be used to halt measurements in progress. Different programming languages and IEEE-488 interface cards provide access to this capability through their own unique commands. The status registers, the error queue, and all configuration states are left unchanged when a device clear message is received. Device clear performs the following actions.

- All measurements in progress are aborted.
- The U2040 X-Series returns to the trigger "idle state".
- The U2040 X-Series input and output buffers are cleared.
- The U2040 X-Series is prepared to accept a new command string.

Making Measurements on Wireless Communication Standards

The following sections describe typical measurements you may want to make.

The optimum method of measuring these Wireless Communication Standards is to use the `SYSTem:PRESet [<character_data>[,<character_data>]]` command and use one of the following values.

Refer to “**SYSTem:PRESet**” on page 346 for more details.

- GSM900
- EDGE
- CDMAone
- CDMA2000
- WCDMA
- BLUetooth
- MCPa
- RADar
- WL802DOT11A
- HIPERLAN2
- WL802DOT11B
- XEVDO
- XEVDV
- TDSCdma
- NADC
- IDEN
- DVB
- WiMAX
- DME
- DME-PRT
- HSDPA
- LTFDD
- LTETDD

Starting a preset example

```
10 *CLS !Clears error queue
20 *RST !Resets settings to their default states
30 :SYST:ERR? <read string> !The system error query should!return
    "0: No error"
40 SYSTem:PRESet GSM900
```

Keysight U2040 X-Series
Wide Dynamic Range Power Sensors
Programming Guide

2 IEEE-488 Common Commands

*CLS	70
*DDT	71
*ESE	73
*ESR?	74
*IDN?	75
*LRN?	76
*OPC	77
*OPT?	78
*RCL	79
*RST	80
*SAV	81
*SRE	82
*STB?	83
*TRG	84
*TST	85
*WAI	86

This chapter describes the IEEE-488 common commands.

*CLS

Syntax

*CLS

Description

The *CLS (Clear Status) command clears the status data structures. The SCPI registers (Questionable Status, Operation Status, and all the other SCPI registers), the Standard Event Status Register, the Status Byte, and the Error/Event Queue are all cleared.

*DDT

Syntax

```
*DDT <arbitrary block program data>|<string program data>
*DDT?
```

Description

The *DDT (Define Device Trigger) command determines the U2040 X-Series response to the *TRG common command. This command effectively turns *TRG into a query, with the measured power being returned.

The query returns the action which is performed on receipt of a *TRG. This is returned as a <definite-length arbitrary block response data> value in the form of #nN<action>.

Parameters

Item	Range of values	Description/Default value
arbitrary block program data	#nN<action> ^{[a] [b]}	The command which is executed on a *TRG.
string program data	"<action>" ^[a]	

[a] The <action> field of the parameter may contain:

```
FETC?
FETC1?
*TRG
TRIG1
```

[b] The first digit after the # indicates the number of following digits. The following digits indicate the length of the data.

Examples

Examples of <arbitrary block program data> parameters are:

```
#15FETC? and #206FETC?
```

Examples of <string program data> are:

```
"FETC1?", "FETC?", and "TRIG1;FETC1"
```

Reset condition

On reset, the <action> field of *DDT is set to *TRG.

Error message

If an invalid parameter is received, error -224, “Illegal parameter value” occurs.

*ESE

Syntax

*ESE <NRf>

*ESE?

Description

The *ESE (Event Status Enable) <NRf> command sets the Standard Event Status Enable Register. This register contains a mask value for the bits to be enabled in the Standard Event Status Register. A 1 in the Enable Register enables the corresponding bit in the Status Register, while a 0 disables the bit. The parameter value, when rounded to an integer and expressed in base 2, represents the bit values of the Standard Event Status Enable Register. **Table 2-1** shows the contents of this register.

The query returns the current contents of the Standard Event Status Enable Register. The format of the return is <NR1> in the range of 0 to 255.

Table 2-1 *ESE mapping

Bit	Weight	Meaning
0	1	Operation Complete
1	2	Request Control (not used)
2	4	Query Error
3	8	Device-Dependent Error
4	16	Execution Error
5	32	Command Error
6	64	User Request
7	128	Power On

Parameter

Item	Range of values	Description/Default value
NRf	0 to 255	A value used to set the Standard Event Status Enable Register.

*ESR?

Syntax

*ESR?

Description

The *ESR? query returns the contents of the Standard Event Status Register and then clears it. The format of the return is <NR1> in the range of 0 to 255. **Table 2-2** shows the contents of this register.

Table 2-2 *ESR? mapping

Bit	Weight	Meaning
0	1	Operation Complete
1	2	Request Control (not used)
2	4	Query Error
3	8	Device-Dependent Error
4	16	Execution Error
5	32	Command Error
6	64	User Request
7	128	Power On

*IDN?

Syntax

```
*IDN?
```

Description

The *IDN? query allows the U2040 X-Series to identify itself. The string returned is, for example:

```
Keysight Technologies,U2041XA,<serial number>,A1.XX.YY
```

where:

- <serial number> uniquely identifies each U2040 X-Series.
- A1.XX.YY represents the firmware revision with XX and YY representing the major and minor revisions respectively.

*LRN?

Syntax

*LRN?

Description

The *LRN? query returns the U2040 X-Series state.

*OPC

Syntax

*OPC

*OPC?

Description

The *OPC (OPeration Complete) command causes the U2040 X-Series to set the operation complete bit in the Standard Event Status Register when all pending device operations have completed.

The query places an ASCII 1 in the output queue when all pending device operations have completed.

*OPT?

Syntax

*OPT?

Description

The *OPT? query reports the options installed in the U2040 X-Series and returns a " " empty string for a standard instrument.

*RCL

Syntax

```
*RCL <NRf>
```

Description

The *RCL <NRf> (ReCaLL) command restores the state of the U2040 X-Series from the specified save/recall register. An instrument setup must have been stored previously in the specified register.

Parameter

Item	Range of values	Description/Default value
NRf	1 to 10	The number of the register to be recalled.

Error message

If the register does not contain a saved state, error -224, "Illegal parameter value" occurs.

*RST

Syntax

*RST

Description

The *RST (ReSeT) command places the U2040 X-Series in a known state. Refer to “**SYSTem:PRESet**” on page 346 for information on the reset values.

*SAV

Syntax

*SAV <NRf>

Description

The *SAV <NRf> (SAVe) command stores the current state of the U2040 X-Series in the specified register.

Parameter

Item	Range of values	Description/Default value
NRf	1 to 10	The number of the register that the current state of the U2040 X-Series is to be saved to.

*SRE

Syntax

*SRE <NRf>

*SRE?

Description

The *SRE <NRf> command enables the bits in the Status Byte enable register. The selected enabled bits are summarized in the “Master Status Summary” (MSS) bit (bit 6) of the Status Byte register. If any of the selected bit condition changes from 0 to 1, a Service Request is generated. **Table 2-3** shows the contents of this register.

The query returns the current contents of the Status Byte enable register. The format of the return is <NR1> in the range of 0 to 255.

Table 2-3 *SRE mapping

Bit	Weight	Meaning
0	1	Not used
1	2	Device Status Register Summary
2	4	Error/Event Queue
3	8	QUEStionable Status Register Summary
4	16	Message Available
5	32	Event Status Byte Summary
6	64	Master Status Summary (Request for service)
7	128	OPERation Status Register Summary

Parameter

Item	Range of values	Description/Default value
NRf	0 to 255	A value used to set the bits in the Status Byte enable register.

*STB?

Syntax

*STB?

Description

The *STB? (Status Byte) query reads the condition register of the Status Byte register and returns a decimal value which corresponds to the binary-weighted sum of all bits set in the register. The format of the return is <NR1> in the range of 0 to 255. **Table 2-4** shows the contents of this register.

Table 2-4 *STB? mapping

Bit	Weight	Meaning
0	1	Not used
1	2	Device Status Register Summary
2	4	Error/Event Queue
3	8	QUEStionable Status Register Summary
4	16	Message Available
5	32	Event Status Byte Summary
6	64	Master Status Summary (Request for service)
7	128	OPERation Status Register Summary

*TRG

Syntax

*TRG

Description

The *TRG (TRiGger) command triggers all channels that are in the wait-for-trigger state. Using the *DDT command may change the function of the *TRG command.

Error messages

- If TRIGger:SOURCE is not set to BUS, error -211, "Trigger ignored" occurs.
- If the U2040 X-Series is not in the wait-for-trigger state, error -211, "Trigger ignored" occurs.

*TST

Syntax

*TST

Description

The *TST? (TeST) query causes the U2040 X-Series to perform the self-test. The test takes approximately 100 seconds.

The result of the test is placed in the output queue.

- 0 is returned if the test passes
- 1 if the test fails

*WAI

Syntax

*WAI

Description

The *WAI (WAI) command causes the U2040 X-Series to wait until either:

- all pending operations are complete
- the device clear command is received
- power is cycled

before executing any subsequent commands or queries.

Keysight U2040 X-Series
Wide Dynamic Range Power Sensors
Programming Guide

3 ABORt Subsystem

ABORt[1] **88**

This chapter describes the ABORt subsystem command.

ABORt[1]

Syntax

```
ABORt [1]
```

Description

This command removes the channel from the wait-for-trigger state and places it in the idle state. It does not affect any other settings of the trigger system. When the `INITiate` command is sent, the trigger system responds as it did before `ABORt` was executed.

If `INITiate:CONTinuous` is ON, then after `ABORt`, the channel immediately goes into the wait-for-trigger state.

Example

```
ABORt          Places the channel in the idle state.
```

Keysight U2040 X-Series Wide Dynamic Range Power Sensors Programming Guide

4 CALCulate Subsystem

CALCulate[1][2]3 4:FEED[1]2	90
CALCulate[1][2]3 4:GAIN:STATe	92
CALCulate[1][2]3 4:GAIN[:MAGNitude]	93
CALCulate[1][2]3 4:LIMit:CLEar:AUTO	94
CALCulate[1][2]3 4:LIMit:CLEar[:IMMEDIATE]	95
CALCulate[1][2]3 4:LIMit:FAIL?	96
CALCulate[1][2]3 4:LIMit:FCOunt?	97
CALCulate[1][2]3 4:LIMit:LOWer[:DATA]	99
CALCulate[1][2]3 4:LIMit:STATe	101
CALCulate[1][2]3 4:LIMit:UPPer[:DATA]	102
CALCulate[1][2]3 4:MATH [:EXPRession]	104
CALCulate[1][2]3 4:MATH [:EXPRession]:CATalogue?	105
CALCulate[1][2]3 4:PHOLd:CLEar	106
CALCulate[1][2]3 4:RELative:STATe	107
CALCulate[1][2]3 4:RELative[:MAGNitude]:AUTO	108

This chapter describes the CALCulate subsystem commands.

CALCulate[1]|2|3|4:FEED[1]|2

Syntax

```
CALCulate[1]|2|3|4:FEED[1]|2 "POW:PEAK"|"POW:PTAV"|"POW:AVER"|"POW:MIN"
CALCulate[1]|2|3|4:FEED[1]|2?
```

Description

This command sets the input measurement mode to be fed to the specified input on the CALC block. It is applied to the measurement after the CALC:MATH:EXPR command has been used to specify which channel the feed is taken from.

Measurement modes are coupled for combination measurements (for example, ratio measurements). For example, if one feed is changed to PTAV, the other is automatically changed to PTAV.

Under certain circumstances, the measurement mode is changed by the CALC:MATH:EXPR command. Refer to "CALCulate[1]|2|3|4:MATH[:EXPRESSION]" on page 104 for further information.

The query returns the current value of the string.

Parameter

Item	Range of values	Description/Default value
string	"POW:PEAK" "POW:PTAV" "POW:AVER" "POW:MIN"	<p>The input measurement type to be fed to the specific input on the CALC block:</p> <ul style="list-style-type: none"> - PEAK: peak power - PTAV: peak to average power - AVER: average power - MIN: minimum power <p>Values may be followed by ON SWEEP[1] 2 3 4 where the numeric specifies the gate to be used for the feed. For example: "POW:PEAK ON SWEEP2".</p> <p>If ON SWEEP[1] 2 3 4 is not supplied, the gate used is left unchanged.</p> <p>A feed of "" (empty string) has no effect if specified.</p>

Example

```
CALC3:FEED2 "POW:AVER ON SWEEP2"
```

Selects the input for FEED2 of CALC3 block to be average power, using gate 2.

Reset condition

On reset, `data_handle` is set to `:POW:AVER`.

Error messages

- If `<string>` contains `ON SWEEP [1] | 2 | 3 | 4` and the feed's `TRIG:SOUR` is not `INT` or `EXT`, error -221, "Settings conflict" occurs.
- If `CALC:FEED` is set to `PEAK`, `MIN`, or `PTAV` when `DET:FUNC` is set to `AVER`, error -221, "Settings conflict" occurs.

CALCulate[1]|2|3|4:GAIN:STATE

Syntax

```
CALCulate[1]|2|3|4:GAIN:STATE ON|OFF|1|0
CALCulate[1]|2|3|4:GAIN:STATE?
```

Description

This command is used on the specified CALCulate block to enable and disable the offset set by the CALCulate[1]|2|3|4:GAIN[:MAGNitude] command.

The query enters a 1 or 0 into the output buffer indicating the status of the offset.

- 1 is returned when the offset is enabled
- 0 is returned when the offset is disabled

Example

```
CALC2:GAIN:STAT 1    Enables the CALCulate2 offset.
```

Reset condition

On reset, the offset is disabled.

Error message

If CALCulate[1]|2|3|4:GAIN[:MAGNitude] is set to ON while [:SENSe[1]:]MRATe is set to FAST, error -221, "Settings conflict" occurs.

CALCulate[1]|2|3|4:GAIN[:MAGNitude]

Syntax

```
CALCulate[1]|2|3|4:GAIN[:MAGNitude] <numeric_value>
CALCulate[1]|2|3|4:GAIN[:MAGNitude]? [MIN|MAX]
```

Description

This command is used to enter a value for the offset on the specified CALCulate block. The offset is applied to the measurement signal after any math calculation.

Entering a value using this command automatically turns the CALCulate[1]|2|3|4:GAIN:STATE command to ON.

The query returns the current setting of the offset or the value associated with MIN and MAX.

Parameter

Item	Range of values	Description/Default value
numeric_value	-100.000 to +100.000 dB DEF MIN MAX	A numeric value for the CALCulate offset: - DEF: the default value is 0 dB - MIN: -100.000 dB - MAX: +100.000 dB

Example

```
CALC2:GAIN 20
```

Enters a CALCulate2 offset of 20 dB.

Reset condition

On reset, the offset is set to 0 dB (DEF).

Error message

If CALCulate[1]|2|3|4:GAIN[:MAGNitude] is set to ON while [:SENSE[1]:]MRATE is set to FAST, error -221, "Settings conflict" occurs.

CALCulate[1]|2|3|4:LIMit:CLEar:AUTO

Syntax

```
CALCulate[1]|2|3|4:LIMit:CLEar:AUTO ON|OFF|1|0|ONCE
CALCulate[1]|2|3|4:LIMit:CLEar:AUTO?
```

Description

This command controls when the fail counter (FCO) is cleared of any limit failures. The FCO is used to determine the results returned by the `CALCulate[1]|2|3|4:LIMit:FAIL?` query.

- If `ON` is specified, the FCO is set to 0 each time a measurement is:
 - Initiated using `INITiate[:IMMediate]`
 - Initiated using `INITiate:CONTinuous ON`
 - Measured using `MEASure?`
 - Read using `READ?`
- If `OFF` is specified, the FCO is not cleared by the above commands.
- If `ONCE` is specified, the FCO is cleared only after the first initialization then starts accumulating any limit failures.

The query enters a 1 or 0 into the output buffer indicating whether limit failures are cleared automatically when a new measurement is initiated on the specified `CALCulate` block.

- 1 is entered into the output buffer when limit failures are cleared automatically when a new measurement is initiated.
- 0 is entered into the output buffer when limit failures are not cleared automatically when a new measurement is initiated.

In the case where limit failures are cleared once, when a query occurs, a 1 is entered into the output buffer if no measurement is initiated. If a measurement is initiated, then 0 is entered.

Example

```
CALC1:LIM:CLE:AUT 1      Switches on automatic clearing of the FCO for
                          CALCulate1.
```

Reset condition

On reset, the `CALCulate` blocks and their measurements are set to `ON`.

CALCulate[1]|2|3|4:LIMit:CLEar[:IMMediate]

Syntax

```
CALCulate[1]|2|3|4:LIMit:CLEar[:IMMediate]
```

Description

This command immediately clears the fail counter (FCO) of any limit failures for the specified CALCulate block. The FCO is used to determine the results returned by the CALCulate[1]|2|3|4:LIMit:FAIL? query.

Example

```
CALC2:LIM:CLE          Clears the FCO for CALCulate2.
```

CALCulate[1]|2|3|4:LIMit:FAIL?

Syntax

```
CALCulate[1]|2|3|4:LIMit:FAIL?
```

Description

This query enters a 1 or 0 into the output buffer indicating whether there have been any limit failures for the CALCulate block. A limit failure is defined as CALC[1]|2|3|4:LIMit:FCO? being non-zero. The fail counter (FCO) can be zeroed using the CALC[1]|2|3|4:LIMit:CLEAr command.

- 1 is returned when one or more limit failures have occurred
- 0 is returned when no limit failures have occurred

Example

```
CALC1:LIM:FAIL?      Queries if there have been any limit failures on CALCulate1.
```

Reset condition

On reset, the buffer is set to zero for all CALCulate blocks.

CALCulate[1]|2|3|4:LIMit:FCOunt?

Syntax

```
CALCulate[1]|2|3|4:LIMit:FCOunt?
```

Description

This query returns the total number of limit failures for the specified CALCulate block.

If the appropriate STATE commands are set to ON, each time a measurement is initiated on the specified window/measurement and the result is outside the limits, the counter is incremented by one.

If the measured value is equal to a limit, this is a limit pass.

The counter is reset to zero by any of the following commands:

- *RST
- CALCulate[1]|2|3|4:LIMit:CLEar:IMMediate
- CALCulate[1]|2|3|4:LIMit:CLEar:AUTO ON

When CALCulate[1]|2|3|4:LIMit:CLEar:AUTO is set to ON, the counter is set to zero *each* time a measurement is:

- measured using MEASure?
- read using READ?
- initiated using:
 - INITiate[:IMMediate] or,
 - INITiate:CONTInuous ON

When CALCulate[1]|2|3|4:LIMit:CLEar:AUTO is set to ONCE, the counter is set to zero the *first* time a measurement is:

- measured using MEASure?
- read using READ?
- initiated using:
 - INITiate[:IMMediate] or,
 - INITiate:CONTInuous ON

The maximum number of errors is $2^{16}-1$. If more than $2^{16}-1$ errors are detected, the counter returns to zero.

Example

`CALC1:LIM:FCO?` Queries the number of limit failures on `CALCulate1`.

Reset condition

On reset, the counter is set to zero for all `CALCulate` blocks.

CALCulate[1]|2|3|4:LIMit:LOWer[:DATA]

Syntax

```
CALCulate[1]|2|3|4:LIMit:LOWer[:DATA] <numeric_value>
CALCulate[1]|2|3|4:LIMit:LOWer[:DATA]? [MIN|MAX]
```

Description

This command enters a value for the lower test limit for the specified CALCulate block used in the CALCulate[1]|2|3|4:LIMit:FAIL? test. The units used are dependent on the current setting of UNIT:POWER and CALCulate:RELative:STATE as shown in **Table 4-1**.

When the measured value is less than the value specified in CALCulate[1]|2|3|4:LIMit:LOWer[:DATA], CALCulate[1]|2|3|4:LIMit:FAIL? reports a fail. When the measured value is greater than or equal to the limit, a fail is not reported.

The query returns the current setting of the lower limit or the values associated with MIN and MAX for the specified CALCulate block.

Table 4-1 Measurement units

Measurement mode	Measurement type	CALC:REL:STAT OFF		CALC:REL:STAT ON	
		Linear	Log	Linear	Log
Single channel	Avg, Pk	Watt	dBm	%	dB
	Pk-Avg	%	dB	%	dB
Ratio	Avg, Pk, Pk-Avg	%	dB	%	dB
Difference	Avg, Pk	Watt	dBm	%	dB
	Pk-Avg	%	dB	%	dB

Parameter

Item	Range of values	Description/Default value
numeric_value	-150 to +230 dBm or -180 to +200 dB DEF MIN MAX	A numeric value for the lower test limit: - DEF: the default is -90 dBm or -120 dB - MIN: -150 dBm or -180 dB - MAX: +230 dBm or +200 dB

Example

```
CALC2:LIM:LOW:DATA 0.1
```

Enters a lower limit for `CALCulate2` depending on the units as follows:

dBm = 0.1 dBm

W = 100 mW

dB = 0.1 dB

% = 0.1%

Reset condition

On reset, the lower limit for all `CALCulate` blocks is set to `-90.00 dBm` or `-120 dB (DEF)`.

CALCulate[1]|2|3|4:LIMit:STATe

Syntax

```
CALCulate[1]|2|3|4:LIMit:STATe ON|OFF|1|0  
CALCulate[1]|2|3|4:LIMit:STATe?
```

Description

This command enables/disables the test limits for the specified CALCulate block.

The query enters 1 or 0 into the output buffer indicating the status of the limit testing feature for the specified CALCulate block.

- 1 is returned when limit testing is enabled
- 0 is returned when limit testing is disabled

Example

```
CALC2:LIM:STAT 1    Enables the limit checking function for CALCulate2.
```

Reset condition

On reset, limit checking is disabled.

Error message

If CALCulate[1|2|3|4]:LIMit:STATe is set to ON while [:SENSe[1]:]MRATe is set to 200, error -221, "Settings conflict" occurs.

CALCulate[1]|2|3|4:LIMit:UPPer[:DATA]

Syntax

```
CALCulate[1]|2|3|4:LIMit:UPPer[:DATA] <numeric_value>
CALCulate[1]|2|3|4:LIMit:UPPer[:DATA]? [MIN|MAX]
```

Description

This command enters a value for the upper test limit for the specified CALCulate block used in the CALCulate[1]|2|3|4:LIMit:FAIL? test. The units used are dependent on the current setting of UNIT:POWER and CALCulate:RELative:STATE as shown in **Table 4-2**. When the measured power is greater than the value specified in CALCulate[1]|2|3|4:LIMit:UPPer[:DATA], CALCulate[1]|2|3|4:LIMit:FAIL? reports a fail. When the measured level is less than or equal to the limit, a fail is not reported.

The query returns the current setting of the upper limit or the values associated with MIN and MAX for the specified CALCulate block.

Table 4-2 Measurement units

Measurement mode	Measurement type	CALC:REL:STAT OFF		CALC:REL:STAT ON	
		Linear	Log	Linear	Log
Single channel	Avg, Pk	Watt	dBm	%	dB
	Pk-Avg	%	dB	%	dB
Ratio	Avg, Pk, Pk-Avg	%	dB	%	dB
Difference	Avg, Pk	Watt	dBm	%	dB
	Pk-Avg	%	dB	%	dB

Parameter

Item	Range of values	Description/Default value
numeric_value	-150 to +230 dBm or -180 to +200 dB DEF MIN MAX	A numeric value for the upper test limit: - DEF: the default is 90 dBm or 120 dB - MIN: -150 dBm or -180 dB - MAX: +230 dBm or +200 dB

Example

```
CALC2:LIM:UPP:DATA 5
```

Enters an upper limit for CALCulate2 depending on the units as follows:

dBm = 5 dBm

W = 5 W

dB = 5 dB

% = 5%

Reset condition

On reset, the upper limit for all CALCulate blocks is set to 90.00 dBm or 120 dB (DEF).

CALCulate[1]|2|3|4:MATH [:EXPRession]

Syntax

```
CALCulate[1]|2|3|4:MATH [:EXPRession] "(SENS1)"|"(SENS1-SENS1)"|"(SENS1/SENS1)"
CALCulate[1]|2|3|4:MATH[:EXPRession]?
```

Description

This command sets the specified CALCulate block to a single channel, difference, or ratio measurement.

The query returns the current math measurement setting on the specified CALCulate block.

Parameter

Item	Range of values	Description/Default value
string	"(SENS1)" "(SENS1-SENS1)" "(SENS1/SENS1)"	A single string value detailing the measurement type. The default value is "(SENS1)".

Example

```
CALC2:MATH "(SENS1/SENS1)"
```

Sets CALCulate2 to make a Channel A/A ratio measurement.

Reset condition

On reset, all CALCulate blocks are set to "(SENS1)".

Error message

If string is not set to "(SENS1)" while [:SENSe[1]:]MRATE is set to FAST, error -221, "Settings conflict" occurs.

CALCulate[1]|2|3|4:MATH [:EXPRession]:CATalogue?

Syntax

```
CALCulate[1]|2|3|4:MATH [:EXPRession]:CATalogue?
```

Description

This query lists all the defined math expressions in the form of comma-separated strings as follows:

```
" (SENS1) ", " (SENS1-SENS1) ", " (SENS1/SENS1) "
```

Each string contains a math expression.

Example

```
CALC1:MATH:CAT?      Lists all the defined math expressions.
```

CALCulate[1]|2|3|4:PHOLd:CLEAr^[1]

Syntax

```
CALCulate[1]|2|3|4:PHOLd:CLEAr
```

Description

This command clears the peak hold value for a specified CALC block so that a new peak hold value can be set.

NOTE

Clearing the peak hold value for a specified CALC block may affect the peak hold value of other CALC blocks, depending on the CALC channel set up (set by CALC:MATH:EXPR).

Example

```
CALC2:PHOL:CLE      Clears the peak hold value for CALC2.
```

Error messages

- If TRIG:SOUR is set to INT or EXT, error -221 "Settings conflict" occurs.
- If DET:FUNC is set to AVER, error -221, "Settings conflict" occurs.

[1] Applicable for U2042XA/U2044XA/U2049XA only.

CALCulate[1]|2|3|4:RELative:STATe

Syntax

```
CALCulate[1]|2|3|4:RELative:STATe ON|OFF|1|0  
CALCulate[1]|2|3|4:RELative:STATe?
```

Description

This command enables/disables the relative mode. If the command is:

- disabled, the measurement signal remains unchanged.
- enabled, the current relative value set by `CALCulate:RELative:MAGNitude:AUTO` is applied to the measurement signal.

The query returns a 1 or 0 into the output buffer.

- 1 is returned when the relative mode is enabled
- 0 is returned when the relative mode is disabled

Example

```
CALC1:REL:STAT OFF    Disables the relative mode on CALCulate1.
```

Reset condition

On reset, the relative mode is disabled.

Error message

If `CALCulate:RELative:STATe` is set to `ON` while `[:SENSE[1] :]MRATe` is set to `FAST`, error -221, "Settings conflict" occurs.

CALCulate[1]|2|3|4:RELative[:MAGNitude]:AUTO

Syntax

```
CALCulate[1]|2|3|4:RELative[:MAGNitude]:AUTO ONCE
CALCulate[1]|2|3|4:RELative[:MAGNitude]:AUTO?
```

Description

This command sets the reference value to be used in the relative measurement. Within the CALCulate block, the relative value is applied to the measurement signal after any math calculations and offsets have been applied.

The value should be set to ONCE to set the reference value to be used in relative measurements. Selecting ONCE sets the reference value to that of the measurement signal after any math calculations and display offsets have been applied. After the reference value has been set, the command returns to OFF. Setting this command to ONCE turns the CALCulate[1]|2|3|4:RELative:STATE command to ON.

If 0 | OFF is selected, no reference value is applied to the measurement signal. There is no situation in which you would want to send this command with OFF. OFF is only available because it is required for the query response. If 1 | ON is selected, it causes error -224, "Illegal parameter value" to occur.

The query always returns OFF.

Example

```
CALC1:REL:AUTO ONCE
```

Sets a reference value to be used in the relative measurement on CALCulate1.

Reset condition

On reset, the reference value is 0.

Error messages

- If CALCulate:RELative[:MAGNitude]:AUTO is set to ONCE while [:SENSE[1]:]MRATE is set to FAST, error -221, "Settings conflict" occurs.
- If the value is set to ON, error -224, "Illegal parameter value" occurs.

Keysight U2040 X-Series
Wide Dynamic Range Power Sensors
Programming Guide

5 CALibration Subsystem

CALibration Subsystem	110
CALibration[1]:ZERO:AUTO	112
CALibration[1]:ZERO:TYPE	113
CALibration[1]:ZERO:NORMAl:AUTO	114
CALibration[1][:ALL]	115

This chapter describes the `CALibration` subsystem commands.

CALibration Subsystem

The CALibration command subsystem is used to zero and calibrate the U2040 X-Series.

The numeric suffix of the CALibration command (CALibration1) refers to Channel A.

Zeroing and calibration of the U2040 X-Series is recommended:

- When a 5°C change in temperature occurs
- When connection to the U2040 X-Series is established
- Every 24 hours
- Prior to measuring low-level signals.

The following CALibration commands are overlapped commands:

- CAL:ALL
- CAL:AUTO
- CAL:ZERO:AUTO
- An overlapped command allows the U2040 X-Series to continue parsing and executing subsequent commands¹ while it is still executing.

CALibration[1]:AUTO

Syntax

```
CALibration[1]:AUTO 0|OFF|1|ON|ONCE  
CALibration[1]:AUTO?
```

Description

This command auto-calibrates channel A when enabled.

When 1|ON is enabled, auto-calibration is updated every 10 minutes.

0|OFF can be set to disable auto-calibration.

The query returns the calibration state.

NOTE

The U2040 X-Series should be zeroed before calibration using the `CALibration:ZERO:AUTO ONCE` command.

Example

```
CAL:AUTO ONCE
```

Causes the U2040 X-Series to perform a calibration on Channel A.

Reset condition

On reset, auto-calibration is disabled.

Error messages

- If calibration was not carried out successfully, error -231, "Data questionable;CAL ERROR" occurs.
- If `CAL:AUTO` is set to ON while `LIST:STAT` is set to ON, error -221, "Settings conflict;list mode is running" occurs.

CALibration[1]:ZERO:AUTO

Syntax

```
CALibration[1]:ZERO:AUTO 0|OFF|1|ON|ONCE
CALibration[1]:ZERO:AUTO?
```

Description

This command causes the U2040 X-Series to perform its auto-zeroing routine when enabled. This adjusts the U2040 X-Series for a zero power reading with or without power supplied to the U2040 X-Series.

When 1|ON is enabled, the zero is maintained by a combination of on-the-fly zero measurements and temperature compensation. The on-the-fly zero measurements are applicable only when the U2040 X-Series is in the NORMa1 measurement mode.

In the AVERAGE measurement mode, auto-zeroing is triggered by an internal timer 24 hours after the last zeroing.

0|OFF can be set to disable auto-zeroing.

The query returns the zeroing state.

NOTE

Ensure that the U2040 X-Series is not connected to the RF source when performing zeroing in the average mode.

Example

```
CAL:ZERO:AUTO ONCE
```

Causes the U2040 X-Series to perform a zeroing routine on Channel A.

Reset condition

On reset, auto-zeroing is disabled.

Error messages

- If zeroing was not carried out successfully, error -231, "Data questionable;ZERO ERROR" occurs.
- If CAL:ZERO:AUTO is set to ON while CAL:ZERO:TYPE is set to EXT, error -221, "Settings conflict" occurs.

CALibration[1]:ZERO:TYPE

Syntax

```
CALibration[1]:ZERO:TYPE EXTernal|INTernal  
CALibration[1]:ZERO:TYPE?
```

Description

This command sets the U2040 X-Series to the external or internal zeroing mode. Upon power up, the U2040 X-Series defaults to the internal zeroing mode.

This query returns the current zeroing mode of either `INT` or `EXT`.

NOTE

Setting this command to `EXTernal` will automatically set `CALibration[1]:ZERO:AUTO` to `OFF`.

Example

```
CAL:ZERO:TYPE EXT      Sets the external zeroing mode.
```

Reset condition

On reset, the zeroing mode is set to internal.

Error message

This command is only able to set the zeroing mode to `EXT` or `INT`. Error -224, "Illegal parameter value" occurs for any other value.

CALibration[1]:ZERO:NORMal:AUTO^[1]

Syntax

```
CALibration[1]:ZERO:NORMal:AUTO 0|OFF|ONCE
```

```
CALibration[1]:ZERO:NORMal:AUTO?
```

Description

This command provides a quick way of zeroing the NORMal path of the U2040 X-Series.

This command causes the U2040 X-Series to perform its zeroing routine when ONCE is selected. This adjusts the U2040 X-Series for a zero power reading with or without power supplied to the U2040 X-Series.

The 0|OFF parameter is only required for the query response and is ignored in the command. If 1|ON is selected, it causes the error -224, “Illegal parameter value” to occur.

The query always returns a value of 0.

Example

```
CAL:ZERO:NORM:AUTO ONCE
```

Causes the U2040 X-Series to perform a zeroing routine on Channel A.

Reset condition

On reset, this command is set to OFF.

Error messages

- If zeroing was not carried out successfully, error -231, “Data questionable;ZERO ERROR” occurs.
- If this command is set to 1|ON, error -224, “Illegal parameter value” occurs.
- If CAL:ZERO:NORM:AUTO is set while SENS:DET:FUNC is set to AVER, error -221, “Settings conflict” occurs.

[1] Applicable for U2042XA/U2044XA/U2049XA only.

CALibration[1][:ALL]

Syntax

```
CALibration[1][:ALL]
```

```
CALibration[1][:ALL]?
```

Description

This command causes the U2040 X-Series to perform a calibration sequence which consists of:

- 1** Zeroing the U2040 X-Series (CALibration[1]:ZERO:AUTO ONCE), and
- 2** Calibrating the U2040 X-Series (CALibration[1]:AUTO ONCE).

When the calibration sequence is completed, this query enters 0 or 1 into the output buffer to indicate if the sequence was successful. If the result is:

- 0, the calibration has passed.
- 1, the calibration has failed.

Example

```
CAL Causes the U2040 X-Series to perform a calibration sequence on Channel A.
```

Error messages

- If calibration was not carried out successfully, error -231, "Data questionable;CAL ERROR" occurs.
- If zeroing was not carried out successfully, error -231, "Data questionable;ZERO ERROR" occurs.

THIS PAGE HAS BEEN INTENTIONALLY LEFT BLANK.

Keysight U2040 X-Series
Wide Dynamic Range Power Sensors
Programming Guide

6 CONFigure Subsystem

CONFigure[1]234[:SCALar][:POWer][:AC]	118
CONFigure[1]234[:SCALar][:POWer][:AC]:DIFFerence	119
CONFigure[1]234[:SCALar][:POWer][:AC]:DIFFerence:RELative	120
CONFigure[1]234[:SCALar][:POWer][:AC]:RATio	122
CONFigure[1]234[:SCALar][:POWer][:AC]:RATio:RELative	123
CONFigure[1]234[:SCALar][:POWer][:AC]:RELative	124

This chapter describes the CONFigure subsystem commands.

CONFigure[1]|2|3|4[:SCALar][:POWer][:AC]

Syntax

```
CONFigure[1]|2|3|4[:SCALar][:POWer][:AC]
[<expected_value>[,<resolution>[,<source_list>]]]
CONFigure[1]|2|3|4[:SCALar][:POWer][:AC]?
```

Description

This command is used on the specified CALCulate block to set:

- the expected power level of the measurement.
- the resolution of the measurement.
- the channel on which the measurement will be made.

The values shown in this command are those that are tested.

The query returns the present configuration of the specified CALCulate block.

Parameters

Item	Range of values	Description/Default value
expected_value	sensor-dependent DEF ^[a]	A numeric value for the expected power level. The units of measurement are dBm and W. The default units are defined by UNIT:POWer.
resolution	1 to 4 ^[b] 1.0, 0.1, 0.01, 0.001 DEF ^[a]	A numeric value for the resolution. If unspecified, the current resolution setting is used.
source_list	(@1)	The channel which the command is implemented on. If unspecified, the current setup is used. If the ratio or difference measurement was set up, it will default to Channel A.

[a] The mnemonic DEF means DEFault. This is not equivalent to the DEFault parameter used in the command subsystems. The parameters must be entered in the specified order. If parameters are omitted, they default from the right. The parameter DEFault is used as a placeholder. Specifying DEF leaves the parameter value unchanged.

[b] When SENS:AVER:COUN:AUTO is enabled, the resolution setting affects the number of averages applied. Refer to "Auto-averaging mode" on page 44 for more information.

Example

```
CONF DEF,2,(@1)    Configures CALCulate1 to measure the power of Channel A,
                    using the current range and a resolution setting of 2.
```

CONFigure[1]|2|3|4[:SCALar][:POWer][:AC]:DIFFerence

Syntax

```
CONFigure[1]|2|3|4[:SCALar][:POWer][:AC]:DIFFerence
[<expected_value>[,<resolution>[,<source_list>]]]
CONFigure[1]|2|3|4[:SCALar][:POWer][:AC]:DIFFerence?
```

Description

This command sets the measurement function and resolution of the specified `CALCulate` block. It sets the measurement function to difference with relative mode off.

The values shown in this command are those that are tested.

The query returns the present configuration of the specified `CALCulate` block.

Parameters

Item	Range of values	Description/Default value
expected_value (for the expected power level)	sensor-dependent DEF ^[a]	The U2040 X-Series ignores the numeric value entered in this parameter. Any value entered is treated like DEF.
resolution	1 to 4 ^[b] 1.0, 0.1, 0.01, 0.001 DEF ^[a]	A numeric value for the resolution. If unspecified, the current resolution setting is used.
source_list	(@1),(@1)	This channel list specifies between which channels the difference is calculated. If unspecified and the current setup is a difference measurement, then this difference setup is used, otherwise it defaults to Channel A-A.

[a] The mnemonic DEF means DEFault. This is not equivalent to the DEFault parameter used in the command subsystems. The parameters must be entered in the specified order. If parameters are omitted, they default from the right. The parameter DEFault is used as a placeholder. Specifying DEF leaves the parameter value unchanged.

[b] When `SENS:AVER:COUN:AUTO` is enabled, the resolution setting affects the number of averages applied. Refer to “Auto-averaging mode” on page 44 for more information.

Example

```
CONF2:DIFF DEF,1,(@1),(@1)
```

Configures `CALCulate2` to make a difference measurement of Channel A – Channel A, using the current range and a resolution of 1.

CONFigure[1]|2|3|4[:SCALar][:POWer][:AC]:DIFFerence:RELative

Syntax

```
CONFigure[1]|2|3|4[:SCALar][:POWer][:AC]:DIFFerence:RELative
[<expected_value>[,<resolution>[,<source_list>]]]
```

```
CONFigure[1]|2|3|4[:SCALar][:POWer][:AC]:DIFFerence:RELative?
```

Description

This command sets the measurement function, range, and resolution of the specified CALCulate block. It sets the measurement function to difference with relative mode on. The relative value used is set by the CALCulate:RELative:MAGNitude:AUTO command.

The values shown in this command are those that are tested.

This query returns the present configuration of the specified CALCulate block.

Parameters

Item	Range of values	Description/Default value
expected_value (for the expected power level)	sensor-dependent DEF ^[a]	The U2040 X-Series ignores the numeric value entered in this parameter. Any value entered is treated like DEF.
resolution	1 to 4 ^[b] 1.0, 0.1, 0.01, 0.001 DEF ^[a]	A numeric value for the resolution. If unspecified, the current resolution setting is used.
source_list	(@1),(@1)	This channel list specifies the channels used to calculate the difference. If unspecified and the current setup is a difference measurement, then this difference setup is used, otherwise it defaults to Channel A-A.

[a] The mnemonic DEF means DEFault. This is not equivalent to the DEFault parameter used in the command subsystems. The parameters must be entered in the specified order. If parameters are omitted, they default from the right. The parameter DEFault is used as a placeholder. Specifying DEF leaves the parameter value unchanged.

[b] When SENS:AVER:COUN:AUTO is enabled, the resolution setting affects the number of averages applied. Refer to “Auto-averaging mode” on page 44 for more information.

Example

```
CONF1:DIFF:REL DEF,1,(@1),(@1)
```

Configures CALCulate1 to make a difference measurement of Channel A – Channel A with relative mode on, using the current range and a resolution of 1.

CONFigure[1]|2|3|4[:SCALar][:POWer][:AC]:RATio

Syntax

```
CONFigure[1]|2|3|4[:SCALar][:POWer][:AC]:RATio
[<expected_value>[,<resolution>[,<source_list>]]]
CONFigure[1]|2|3|4[:SCALar][:POWer][:AC]:RATio?
```

Description

This command sets the measurement function, range, and resolution of the specified CALCulate block. It sets the measurement function to ratio with relative mode off.

The values shown in this command are those that are tested.

The query returns the present configuration of the specified CALCulate block.

Parameters

Item	Range of values	Description/Default value
expected_value (for the expected power level)	sensor-dependent DEF ^[a]	The U2040 X-Series ignores the numeric value entered in this parameter. Any value entered is treated like DEF.
resolution	1 to 4 ^[b] 1.0, 0.1, 0.01, 0.001 DEF ^[a]	A numeric value for the resolution. If unspecified, the current resolution setting is used.
source_list	(@1),(@1)	This channel list specifies the channels used to calculate the ratio. If unspecified and the current setup is a ratio measurement, then this ratio setup is used, otherwise it defaults to Channel A/A.

[a] The mnemonic DEF means DEFault. This is not equivalent to the DEFault parameter used in the command subsystems. The parameters must be entered in the specified order. If parameters are omitted, they default from the right. The parameter DEFault is used as a placeholder. Specifying DEF leaves the parameter value unchanged.

[b] When SENS:AVER:COUN:AUTO is enabled, the resolution setting affects the number of averages applied. Refer to “Auto-averaging mode” on page 44 for more information.

Example

```
CONF1:RAT DEF,4,(@1),(@1)
```

Configures CALCulate1 to make a ratio measurement of Channel A over Channel A, using the current range and a resolution setting of 4.

CONFigure[1]|2|3|4[:SCALar][:POWer][:AC]:RATio:RELative

Syntax

```
CONFigure[1]|2|3|4[:SCALar][:POWer][:AC]:RATio:RELative
[<expected_value>[,<resolution>[,<source_list>]]]
CONFigure[1]|2|3|4[:SCALar][:POWer][:AC]:RATio:RELative?
```

Description

This command sets the measurement function, range, and resolution of the specified CALCulate block. It sets the measurement function to ratio with relative mode on. The relative value used is that set by the CALCulate:RELative:MAGNitude:AUTO command.

The values shown in this command are those that are tested.

The query returns the present configuration of the specified CALCulate block.

Parameters

Item	Range of values	Description/Default value
expected_value (for the expected power level)	sensor-dependent DEF ^[a]	The U2040 X-Series ignores the numeric value entered in this parameter. Any value entered is treated like DEF.
resolution	1 to 4 ^[b] 1.0, 0.1, 0.01, 0.001 DEF ^[a]	A numeric value for the resolution. If unspecified, the current resolution setting is used.
source_list	(@1),(@1)	This channel list specifies the channels used to calculate the ratio. If unspecified and the current setup is a ratio measurement, then this ratio setup is used, otherwise it defaults to Channel A/A.

[a] The mnemonic DEF means DEFault. This is not equivalent to the DEFault parameter used in the command subsystems. The parameters must be entered in the specified order. If parameters are omitted, they default from the right. The parameter DEFault is used as a placeholder. Specifying DEF leaves the parameter value unchanged.

[b] When SENS:AVER:COUN:AUTO is enabled, the resolution setting affects the number of averages applied. Refer to “Auto-averaging mode” on page 44 for more information.

Example

```
CONF1:RAT:REL DEF,1,(@1),(@1)
```

Configures the CALCulate1 to make a ratio measurement of Channel A over Channel A with relative mode on, using the current range and a resolution setting of 1.

CONFigure[1]|2|3|4[:SCALar][:POWer][:AC]:RELative

Syntax

```
CONFigure[1]|2|3|4[:SCALar][:POWer][:AC]:RELative
[<expected_value>[,<resolution>[,<source_list>]]]
CONFigure[1]|2|3|4[:SCALar][:POWer][:AC]:RELative?
```

Description

This command sets the measurement function, range, and resolution of the specified CALCulate block. It sets the measurement function to single channel with relative mode on. The relative value used is that set by the CALCulate:RELative:MAGNitude:AUTO command.

The values shown in this command are those that are tested.

The query returns the present configuration of the specified CALCulate block.

Parameters

Item	Range of values	Description/Default value
expected_value (for the expected power level)	sensor-dependent DEF ^[a]	A numeric value for the expected power level. The units of measurement are dBm and W. The default units are defined by UNIT:POWer.
resolution	1 to 4 ^[b] 1.0, 0.1, 0.01, 0.001 DEF ^[a]	A numeric value for the resolution. If unspecified, the current resolution setting is used.
source_list	(@1)	The channel which the command is implemented on. If unspecified, the current setup is used. If the ratio or difference measurement was set up, it will default to Channel A.

[a] The mnemonic DEF means DEFault. This is not equivalent to the DEFault parameter used in the command subsystems. The parameters must be entered in the specified order. If parameters are omitted, they default from the right. The parameter DEFault is used as a placeholder. Specifying DEF leaves the parameter value unchanged.

[b] When SENS:AVER:COUN:AUTO is enabled, the resolution setting affects the number of averages applied. Refer to “Auto-averaging mode” on page 44 for more information.

Example

```
CONF2:REL -20DBM, 3, (@1)
```

Configures CALCulate2 to measure the relative power of Channel A, using an expected power level of -20 dBm and a resolution setting of 3.

CONFigure[1]|2|3|4?

Syntax

```
CONFigure [1] | 2 | 3 | 4 ?
```

Description

This query returns the present configuration of the specified CALCulate block.

The string returned depends on the setting of the CALCulate:MATH and CALCulate:RELative:STATe commands.

The configuration is returned as a quoted string in the following format:

```
"<function> <expected_value>,<resolution>,<source_list>"
```

CALCulate:MATH	CALCulate:RELative:STATe	Function	<source_list>
(SENSe1)	OFF	:POW:AC	(@1)
(SENSe1)	ON	:POW:AC:REL	(@1)
(SENSe1 - SENSe1)	OFF	:POW:AC:DIFF	(@1), (@1)
(SENSe1 - SENSe1)	ON	:POW:AC:DIFF:REL	(@1), (@1)
(SENSe1 / SENSe1)	OFF	:POW:AC:RAT	(@1), (@1)
(SENSe1 / SENSe1)	ON	:POW:AC:RAT:REL	(@1), (@1)

<expected_value> returns the expected value sent by the last CONFigure command or +20 dBm by default.

<resolution> returns the resolution value in the <NR1> format in the range of 1 through 4.

Example

```
CONF2?      Queries the current configuration of the CALCulate2 measurement.
```

Reset condition

On reset:

- The command function is set to :POW:AC.
- The expected power level is set to +20 dBm.
- The resolution is set to 3.
- The source list is set to Channel A.

THIS PAGE HAS BEEN INTENTIONALLY LEFT BLANK.

Keysight U2040 X-Series
Wide Dynamic Range Power Sensors
Programming Guide

7 FETCh Subsystem

FETCh[1]2 3 4[:SCALar][:POWer][:AC]? 128
FETCh[1]2 3 4[:SCALar][:POWer][:AC]:DIFFerence? 130
FETCh[1]2 3 4[:SCALar][:POWer][:AC]:DIFFerence:RELative? 132
FETCh[1]2 3 4[:SCALar][:POWer][:AC]:RATio? 134
FETCh[1]2 3 4[:SCALar][:POWer][:AC]:RATio:RELative? 136
FETCh[1]2 3 4[:SCALar][:POWer][:AC]:RELative? 138

This chapter describes the `FETCh` subsystem commands.

FETCh[1]|2|3|4[:SCALAr][:POWer][:AC]?

Syntax

```
FETCh[1] | 2 | 3 | 4 [:SCALAr] [:POWer] [:AC] ?
[<expected_value>[, <resolution>[, <source_list>]]]
```

Description

This query sets the specified CALCulate block measurement function to single channel with relative mode off, recalculates the measurement, and places the result on the bus. The result is a power-based measurement and is expressed in the units defined by UNIT[1] | 2 | 3 | 4 :POWer.

Parameters

Item	Range of values	Description/Default value
expected_value (for the expected power level)	sensor-dependent DEF ^[a]	The expected power level parameter can be set to DEF or a numeric value. If a value is entered, it should correspond to that set by CONFigure otherwise an error occurs. The units of measurement are dBm and W. The default units are defined by UNIT : POWer.
resolution	1 to 4 ^[b] 1.0, 0.1, 0.01, 0.001 DEF ^[a]	A numeric value for the resolution. If it is unspecified, the current resolution setting is used. If a value is entered, it should correspond to the current resolution setting otherwise an error occurs.
source_list	(@1)	The channel which the command is implemented on. If unspecified, the current setup is used. If the ratio or difference measurement was set up, it will default to Channel A.

[a] The mnemonic DEF means DEFault. This is not equivalent to the DEFault parameter used in the command subsystems. The parameters must be entered in the specified order. If parameters are omitted, they default from the right. The parameter DEFault is used as a placeholder. Specifying DEF leaves the parameter value unchanged.

[b] When SENS: AVER: COUN: AUTO is enabled, the resolution setting affects the number of averages applied. Refer to “Auto-averaging mode” on page 44 for more information.

Example

```
FETC2?           Queries the CALCulate2 measurement result.
```

Error messages

- If the last measurement is not valid, error –230, “Data corrupt or stale” occurs. A measurement is valid after it has been initiated. It becomes invalid when either a reset occurs or any measurement parameter, for example frequency, is changed.
- If the expected value and resolution parameters are not the same as the current expected value and resolution setting on the specified `CALCulate` block, error –221, “Settings conflict” occurs.

FETCh[1]|2|3|4[:SCALAr][:POWEr][:AC]:DIFFerence?

Syntax

```
FETCh[1] | 2 | 3 | 4 [:SCALAr] [:POWEr] [:AC] :DIFFerence?
[<expected_value>[, <resolution>[, <source_list>]]]
```

Description

This query sets the specified CALCulate block measurement function to power difference with relative mode off, recalculates the measurement, and places the results on the bus. The result is a power-based measurement and is expressed in the units defined by UNIT[1] | 2 | 3 | 4 :POWer.

Parameters

Item	Range of values	Description/Default value
expected_value (for the expected power level)	sensor-dependent DEF ^[a]	The expected power level parameter can be set to DEF or a numeric value. If a value is entered, it should correspond to that set by CONFIGure otherwise an error occurs. The units of measurement are dBm and W. The default units are defined by UNIT : POWer.
resolution	1 to 4 ^[b] 1.0, 0.1, 0.01, 0.001 DEF ^[a]	A numeric value for the resolution. If it is unspecified, the current resolution setting is used. If a value is entered, it should correspond to the current resolution setting otherwise an error occurs.
source_list	(@1),(@1)	This channel list specifies the channels used to calculate the difference. If unspecified and the current setup is a difference measurement, then this difference setup is used, otherwise it defaults to Channel A-A.

[a] The mnemonic DEF means DEFault. This is not equivalent to the DEFault parameter used in the command subsystems. The parameters must be entered in the specified order. If parameters are omitted, they default from the right. The parameter DEFault is used as a placeholder. Specifying DEF leaves the parameter value unchanged.

[b] When SENS : AVER : COUN : AUTO is enabled, the resolution setting affects the number of averages applied. Refer to "Auto-averaging mode" on page 44 for more information.

Example

```
FETC4 : DIFF?      Queries the CALCulate4 difference measurement.
```

Error messages

- If the last measurement is not valid, error –230, “Data corrupt or stale” occurs. A measurement is valid after it has been initiated. It becomes invalid when either a reset occurs or any measurement parameter, for example frequency, is changed.
- If the expected value and resolution parameters are not the same as the current expected value and resolution settings on the specified `CALCulate` block, error –221, “Settings conflict” occurs.

FETCh[1]|2|3|4[:SCALAr][:POWer][:AC]:DIFFerence:RELative?

Syntax

```
FETCh[1] | 2 | 3 | 4 [ : SCALAr ] [ : POWer ] [ : AC ] : DIFFerence : RELative ?
[ <expected_value> [ , <resolution> [ , <source_list> ] ] ]
```

Description

This query sets the specified CALCulate block measurement function to power difference with relative mode on, recalculates the measurement, and places the results on the bus. The result is a ratio-based measurement and is expressed in the units defined by UNIT[1] | 2 | 3 | 4 : POWer : RATio.

The relative value used is that set by the CALCulate : RELative : MAGNitude : AUTO command.

Parameters

Item	Range of values	Description/Default value
expected_value (for the expected power level)	sensor-dependent DEF ^[a]	The expected power level parameter can be set to DEF or a numeric value. If a value is entered, it should correspond to that set by CONFIGure otherwise an error occurs. The units of measurement are dBm and W. The default units are defined by UNIT : POWer.
resolution	1 to 4 ^[b] 1.0, 0.1, 0.01, 0.001 DEF ^[a]	A numeric value for the resolution. If it is unspecified, the current resolution setting is used. If a value is entered, it should correspond to the current resolution setting otherwise an error occurs.
source_list	(@1),(@1)	This channel list specifies the channels used to calculate the difference. If unspecified and the current setup is a difference measurement, then this difference setup is used, otherwise it defaults to Channel A-A.

[a] The mnemonic DEF means DEFault. This is not equivalent to the DEFault parameter used in the command subsystems. The parameters must be entered in the specified order. If parameters are omitted, they default from the right. The parameter DEFault is used as a placeholder. Specifying DEF leaves the parameter value unchanged.

[b] When SENS : AVER : COUN : AUTO is enabled, the resolution setting affects the number of averages applied. Refer to “Auto-averaging mode” on page 44 for more information.

Example

```
FETC1:DIFF:REL? DEF,3,(@1),(@1)
```

Queries the `CALCulate1` relative difference measurement of Channel A – Channel A, using the current range and a resolution setting of 3.

Error messages

- If the last measurement is not valid, error –230, “Data corrupt or stale” occurs. A measurement is valid after it has been initiated. It becomes invalid when either a reset occurs or any measurement parameter, for example frequency, is changed.
- If the expected value and resolution parameters are not the same as the current expected value and resolution settings on the specified `CALCulate` block, error –221, “Settings conflict” occurs.

FETCh[1]|2|3|4[:SCALAr][:POWer][:AC]:RATio?

Syntax

```
FETCh[1] | 2 | 3 | 4 [:SCALAr] [:POWer] [:AC] :RATio?
[<expected_value>[, <resolution>[, <source_list>]]]
```

Description

This query sets the specified `CALCulate` block measurement function to power ratio with relative mode off, recalculates the measurement, and places the results on the bus. The result is a ratio-based measurement and is expressed in the units defined by `UNIT[1] | 2 | 3 | 4 :POWer :RATio`.

Parameters

Item	Range of values	Description/Default value
expected_value (for the expected power level)	sensor-dependent DEF ^[a]	The expected power level parameter can be set to <code>DEF</code> or a numeric value. If a value is entered, it should correspond to that set by <code>CONFigure</code> otherwise an error occurs. The units of measurement are dBm and W. The default units are defined by <code>UNIT : POWer</code> .
resolution	1 to 4 ^[b] 1.0, 0.1, 0.01, 0.001 DEF ^[a]	A numeric value for the resolution. If it is unspecified, the current resolution setting is used. If a value is entered, it should correspond to the current resolution setting otherwise an error occurs.
source_list	(@1),(@1)	This channel list specifies the channels used to calculate the ratio. If unspecified and the current setup is a ratio measurement, then this ratio setup is used, otherwise it defaults to Channel A/A.

[a] The mnemonic `DEF` means `DEFault`. This is not equivalent to the `DEFault` parameter used in the command subsystems. The parameters must be entered in the specified order. If parameters are omitted, they default from the right. The parameter `DEFault` is used as a placeholder. Specifying `DEF` leaves the parameter value unchanged.

[b] When `SENS : AVER : COUN : AUTO` is enabled, the resolution setting affects the number of averages applied. Refer to **"Auto-averaging mode"** on page 44 for more information.

Example

```
FETC2:RAT? DEF,1, (@1), (@1)
```

Queries the `CALCulate2` ratio measurement of Channel A over Channel A, using the current range and a resolution of 1.

Error messages

- If the last measurement is not valid, error –230, “Data corrupt or stale” occurs. A measurement is valid after it has been initiated. It becomes invalid when either a reset occurs or any measurement parameter, for example frequency, is changed.
- If the expected value and resolution parameters are not the same as the current expected value and resolution settings on the specified `CALCulate` block, error –221, “Settings conflict” occurs.

FETCh[1]|2|3|4[:SCALAr][:POWEr][:AC]:RATio:RELative?

Syntax

```
FETCh[1] | 2 | 3 | 4 [:SCALAr] [:POWEr] [:AC] :RATio:RELative?
[<expected_value>[, <resolution>[, <source_list>]]]
```

Description

This query sets the specified `CALCulate` block measurement function to power ratio with relative mode on, recalculates the measurement, and places the results on the bus. The result is a ratio-based measurement and is expressed in the units defined by `UNIT[1] | 2 | 3 | 4 :POWEr:RATio`. The relative value used is that set by the `CALCulate:RELative:MAGNitude:AUTO` command.

Parameters

Item	Range of values	Description/Default value
expected_value (for the expected power level)	sensor-dependent DEF ^[a]	The expected power level parameter can be set to <code>DEF</code> or a numeric value. If a value is entered, it should correspond to that set by <code>CONFigure</code> otherwise an error occurs. The units of measurement are dBm and W. The default units are defined by <code>UNIT:POWEr</code> .
resolution	1 to 4 ^[b] 1.0, 0.1, 0.01, 0.001 DEF ^[a]	A numeric value for the resolution. If it is unspecified, the current resolution setting is used. If a value is entered, it should correspond to the current resolution setting otherwise an error occurs.
source_list	(@1),(@1)	This channel list specifies the channels used to calculate the ratio. If unspecified and the current setup is a ratio measurement, then this ratio setup is used, otherwise it defaults to Channel A/A.

[a] The mnemonic `DEF` means `DEFault`. This is not equivalent to the `DEFault` parameter used in the command subsystems. The parameters must be entered in the specified order. If parameters are omitted, they default from the right. The parameter `DEFault` is used as a placeholder. Specifying `DEF` leaves the parameter value unchanged.

[b] When `SENS:AVER:COUN:AUTO` is enabled, the resolution setting affects the number of averages applied. Refer to **"Auto-averaging mode"** on page 44 for more information.

Example

```
FETC:RAT:REL?      Queries the CALCulate1 relative ratio measurement.
```

Error messages

- If the last measurement is not valid, error –230, “Data corrupt or stale” occurs. A measurement is valid after it has been initiated. It becomes invalid when either a reset occurs or any measurement parameter, for example frequency, is changed.
- If the expected value and resolution parameters are not the same as the current expected value and resolution settings on the specified CALCulate block, error –221, “Settings conflict” occurs.

FETCh[1]|2|3|4[:SCALAr][:POWER][:AC]:RELative?

Syntax

```
FETCh[1] | 2 | 3 | 4 [:SCALAr] [:POWER] [:AC] :RELative?
[<expected_value>[, <resolution>[, <source_list>]]]
```

Description

This query sets the specified CALCulate block measurement function to single channel with relative mode on, recalculates the measurement, and places the results on the bus. The result is a ratio-based measurement and is expressed in the units defined by UNIT[1] | 2 | 3 | 4 :POWER:RATio.

The relative value used is that set by the CALCulate:RELative:MAGNitude:AUTO command.

Parameters

Item	Range of values	Description/Default value
expected_value (for the expected power level)	sensor-dependent DEF ^[a]	The expected power level parameter can be set to DEF or a numeric value. If a value is entered, it should correspond to that set by CONFIGure otherwise an error occurs. The units of measurement are dBm and W. The default units are defined by UNIT:POWER.
resolution	1 to 4 ^[b] 1.0, 0.1, 0.01, 0.001 DEF ^[a]	A numeric value for the resolution. If it is unspecified, the current resolution setting is used. If a value is entered, it should correspond to the current resolution setting otherwise an error occurs.
source_list	(@1)	The channel which the command is implemented on. If unspecified, the current setup is used. If the ratio or difference measurement was set up, it will default to Channel A.

[a] The mnemonic DEF means DEFault. This is not equivalent to the DEFault parameter used in the command subsystems. The parameters must be entered in the specified order. If parameters are omitted, they default from the right. The parameter DEFault is used as a placeholder. Specifying DEF leaves the parameter value unchanged.

[b] When SENS:AVER:COUN:AUTO is enabled, the resolution setting affects the number of averages applied. Refer to “Auto-averaging mode” on page 44 for more information.

Example

```
FETC1:REL? DEF, 2, (@1)
```

Queries the CALCulate1 relative measurement of Channel A, using the current range and a resolution setting of 2.

Error messages

- If the last measurement is not valid, error –230, “Data corrupt or stale” occurs. A measurement is valid after it has been initiated. It becomes invalid when either a reset occurs or any measurement parameter, for example frequency, is changed.
- If the expected value and resolution parameters are not the same as the current expected value and resolution settings on the specified `CALCulate` block, error –221, “Settings conflict” occurs.

THIS PAGE HAS BEEN INTENTIONALLY LEFT BLANK.

Keysight U2040 X-Series
Wide Dynamic Range Power Sensors
Programming Guide

8 FORMat Subsystem

FORMat[:READings]:BORDER [142](#)
FORMat[:READings][:DATA] [143](#)

This chapter describes the FORMat subsystem commands.

FORMat[:READings]:BORDER

Syntax

```
FORMat[:READings]:BORDER NORMal|SWAPped  
FORMat[:READings]:BORDER?
```

Description

This command controls whether the binary data is transferred in normal or swapped Byte ORDER. It is only used when FORMat[:READings][:DATA] is set to REAL.

The query returns the current setting of the byte order. The format of the response is NORMal or SWAPped.

Example

```
FORM:BORD SWAP      Sets the byte order to swapped.
```

Reset condition

On reset, this value is set to NORMal.

FORMat[:READings][:DATA]

Syntax

```
FORMat[:READings][:DATA] ASCii|REAL
```

```
FORMat[:READings][:DATA]?
```

Description

This command sets the data format for transferring numeric information to either `ASCii` or `REAL`:

- When the format type is `ASCii`, numeric data is output as ASCII bytes in the `<NR3>` format.
- When the format type is `REAL`, numeric data is output as IEEE 754 64-bit floating point numbers in a definite length block. The result is an 8-byte block per number. Each complete block is terminated by a line feed character.

The query returns the current setting of format: either `ASCii` or `REAL`.

NOTE

The `FORMat` data formatting is not affected by the `TRACe` subsystem data formatting.

Example

```
FORM REAL      Sets the format to REAL.
```

Reset condition

On reset, the format is set to `ASCii`.

THIS PAGE HAS BEEN INTENTIONALLY LEFT BLANK.

Keysight U2040 X-Series
Wide Dynamic Range Power Sensors
Programming Guide

9 INITiate Subsystem

INITiate[1]:CONTInuous	146
INITiate[1]:CONTInuous:ALL	147
INITiate[1]:CONTInuous:SEQuence[1]	148
INITiate[1]:IMMEDIATE	149
INITiate[1]:IMMEDIATE:ALL	150
INITiate[1]:IMMEDIATE:SEQuence[1]	151

This chapter describes the `INITiate` subsystem commands.

INITiate[1]:CONTInuous

Syntax

```
INITiate[1]:CONTInuous ON|OFF|1|0
INITiate[1]:CONTInuous?
```

Description

This command sets the U2040 X-Series for either a single trigger cycle or continuous trigger cycles. A trigger cycle means that the U2040 X-Series exits the wait-for-trigger state and starts a measurement.

If `INITiate:CONTInuous` is set to:

- `OFF`, the trigger system remains in the idle state until it is set to `ON`, or `INITiate:IMMediate` is received. Once this trigger cycle is complete, the trigger system returns to the idle state.
- `ON`, the trigger system is initiated and exits the idle state. On completion of each trigger cycle, the trigger system immediately commences another trigger cycle without entering the idle state.

The query enters a 1 or 0 into the output buffer.

- 1 is returned when there is continuous triggering
- 0 is returned when there is only a single trigger

NOTE

This command performs the same function as `INITiate:CONTInuous:SEQuence[1]`.

Example

```
INIT:CONT ON    Initiates the trigger.
```

Reset condition

- On reset (`*RST`), this command is set to `OFF`.
- On preset (`SYSTEM:PRESet`) and U2040 X-Series power-up, if `TRIGger[:SEQuence[1]]:SOURce` is set to `INT[1]` or `EXT`, `INITiate:CONTInuous` is not changed. For other trigger sources, `INITiate:CONTInuous` is set to `ON`.

INITiate[1]:CONTinuous:ALL

Syntax

```
INITiate[1]:CONTinuous:ALL ON|OFF|1|0  
INITiate[1]:CONTinuous:ALL?
```

Description

This command sets all trigger sequences to be continuously initiated.

If `INITiate:CONTinuous:ALL` is set to:

- `ON`, trigger sequences are set to be continuously initiated
- `OFF`, trigger sequences are not set to be continuously initiated

The query enters a 1 or 0 into the output buffer.

- 1 is returned when trigger sequences are set to be continuous
- 0 is returned when trigger sequences are not set to be continuous

Example

```
INIT:CONT:ALL ON           Sets all trigger sequences to be continuously initiated.
```

Reset condition

On reset (`*RST`), this command is disabled.

On preset (`SYSTEM:PRESet`) and U2040 X-Series power-up, this command is enabled.

INITiate[1]:CONTInuous:SEQuence[1]

Syntax

```
INITiate[1]:CONTInuous:SEQuence[1] ON|OFF|1|0
INITiate[1]:CONTInuous:SEQuence[1]?
```

Description

This command sets the U2040 X-Series for either a single trigger cycle or continuous trigger cycles. A trigger cycle means that the U2040 X-Series exits the wait-for-trigger state and starts a measurement.

If `INITiate:CONTInuous:SEQuence[1]` is set to:

- `OFF`, the trigger system remains in the idle state until it is set to `ON`, or `INITiate:IMMediate` is received. Once this trigger cycle is complete, the trigger system returns to the idle state.
- `ON`, the trigger system is initiated and exits the idle state. On completion of each trigger cycle, the trigger system immediately commences another trigger cycle without entering the idle state.

The query enters a 1 or 0 into the output buffer.

- 1 is returned when there is continuous triggering
- 0 is returned when there is only a single trigger

NOTE

This command performs the same function as `INITiate[1]:CONTInuous`.

Example

```
INIT:CONT:SEQ ON      Initiates the trigger.
```

Reset conditions

- On reset (`*RST`), this command is disabled.
- On preset (`SYSTEM:PRESet`) and U2040 X-Series power-up, this command is enabled.

INITiate[1][:IMMediate]

Syntax

```
INITiate[1][:IMMediate]
```

Description

This command sets the U2040 X-Series in the wait-for-trigger state. When a trigger is received, the measurement is taken and the result is placed in the U2040 X-Series memory. If `TRIGger:SOURce` is set to `IMMediate`, the measurement begins as soon as `INITiate[1][:IMMediate]` is executed.

Use `FETCh?` to transfer a measurement from memory to the output buffer. Refer to **Chapter 7**, "FETCh Subsystem" for further details.

NOTE

This command performs the same function as `INITiate[:IMMediate]:SEquence[1]`.

Example

```
INIT          Places the U2040 X-Series in the wait-for-trigger state.
```

Error message

If the U2040 X-Series is not in the idle state or `INITiate:CONTinuous` is ON, error -213, "INIT ignored" occurs.

INITiate[1][:IMMEDIATE]:ALL

Syntax

```
INITiate[1] [:IMMEDIATE]:ALL
```

Description

This command initiates all trigger sequences.

Example

```
INIT:ALL          Initiates all trigger sequences.
```

Error message

If the U2040 X-Series is not in the idle state or `INITiate:CONTinuous` is ON, error -213, "INIT ignored" occurs.

INITiate[1][:IMMediate]:SEQuence[1]

Syntax

```
INITiate[1][:IMMediate]:SEQuence[1]
```

Description

This command sets the U2040 X-Series in the wait-for-trigger state. When a trigger is received, the measurement is taken and the result is placed in the U2040 X-Series memory. If `TRIGger:SOURce` is set to `IMMediate`, the measurement begins as soon as `INITiate[1][:IMMediate]` is executed.

Use `FETCH?` to transfer a measurement from memory to the output buffer. Refer to **Chapter 7**, "FETCH Subsystem" for further information.

NOTE

This command performs the same function as `INITiate[1][:IMMediate]`.

Example

```
INIT:SEQ          Places the U2040 X-Series in the wait-for-trigger state.
```

Error message

If the U2040 X-Series is not in the "idle" state or `INITiate:CONTinuous` is ON, error -213, "INIT ignored" occurs.

THIS PAGE HAS BEEN INTENTIONALLY LEFT BLANK.

Keysight U2040 X-Series
Wide Dynamic Range Power Sensors
Programming Guide

10 INPut Subsystem

INPut:TRIGger:IMPedance [154](#)

This chapter describes the `INPut` subsystem commands.

INPut:TRIGger:IMPedance

Syntax

```
INPut:TRIGger:IMPedance LOW|HIGH  
INPut:TRIGger:IMPedance?
```

Description

This command sets the impedance of the U2040 X-Series trigger input:

- LOW: 50 Ω
- HIGH: 100 k Ω (default)

The query returns the current trigger input impedance setting.

NOTE

This impedance setting is not cleared each time you cycle the U2040 X-Series power.

Example

```
INP:TRIG:IMP LOW           Sets the trigger input impedance to low (50  $\Omega$ ).
```

Reset condition

On reset, the trigger input impedance is set to HIGH.

Error message

If the trigger input impedance is not set to HIGH or LOW, error -224, "Illegal parameter value" occurs.

Keysight U2040 X-Series
Wide Dynamic Range Power Sensors
Programming Guide

11 LXI Subsystem

LXI:IDENTify[:STATE] **156**

This chapter describes the LXI subsystem commands.

LXI:IDENTify[:STATe]

Syntax

```
LXI:IDENTify[:STATe] ON|OFF|1|0  
LXI:IDENTify[:STATe]?
```

Description

This command enables or disables the LXI identification.

The query indicates whether or not the LXI identification is enabled or disabled.

- 1 is returned when the LXI identification is enabled
- 0 is returned when the LXI identification is disabled

Example

```
LXI:IDEN 1           Enables the LXI identification.
```

Keysight U2040 X-Series
Wide Dynamic Range Power Sensors
Programming Guide

12 MEASure Subsystem

MEASure[1][2 3 4[:SCALar][:POWer][:AC]? 158
MEASure[1][2 3 4[:SCALar][:POWer][:AC]:DIFFerence? 159
MEASure[1][2 3 4[:SCALar][:POWer][:AC]:DIFFerence:RELative? 160
MEASure[1][2 3 4[:SCALar][:POWer][:AC]:RATio? 161
MEASure[1][2 3 4[:SCALar][:POWer][:AC]:RATio:RELative? 162
MEASure[1][2 3 4[:SCALar][:POWer][:AC]:RELative? 163

This chapter describes the MEASure subsystem commands.

MEASure[1]|2|3|4[:SCALar][:POWer][:AC]?

Syntax

```
MEASure[1]|2|3|4[:SCALar][:POWer][:AC]?
[<expected_value>[,<resolution>[,<source_list>]]]
```

Description

This command sets the specified `CALCulate` block measurement function to single channel with relative mode off, aborts, configures the `CALCulate` block then initiates Channel A, calculates the measurement result, and places the result on the bus.

The values shown in this command are those that are tested.

Parameters

Item	Range of values	Description/Default value
expected_value (for the expected power level)	sensor-dependent DEF ^[a]	A numeric value for the expected power level. The units of measurement are dBm and W. The default units are defined by <code>UNIT:POWer</code> .
resolution	1 to 4 ^[b] 1.0, 0.1, 0.01, 0.001 DEF ^[a]	A numeric value for the resolution. If unspecified, the current resolution setting is used.
source_list	(@1)	The channel which the command is implemented on. If unspecified, the current setup is used. If the ratio or difference measurement was set up, it will default to Channel A.

[a] The mnemonic `DEF` means `DEFault`. This is not equivalent to the `DEFault` parameter used in the command subsystems. The parameters must be entered in the specified order. If parameters are omitted, they default from the right. The parameter `DEFault` is used as a placeholder. Specifying `DEF` leaves the parameter value unchanged.

[b] When `SENS:AVER:COUN:AUTO` is enabled, the resolution setting affects the number of averages applied. Refer to “Auto-averaging mode” on page 44 for more information.

Example

```
MEAS2? -20DBM,1,(@1)
```

Queries the `CALCulate2` measurement of Channel A, using an expected power level of -20 dBm and a resolution setting of 1.

MEASure[1]|2|3|4[:SCALar][:POWer][:AC]:DIFFerence?

Syntax

```
MEASure[1]|2|3|4[:SCALar][:POWer][:AC]:DIFFerence?
[<expected_value>[,<resolution>[,<source_list>]]]
```

Description

This query sets the specified `CALCulate` block measurement function to the difference mode with relative mode off, aborts, configures then initiates Channel A, calculates the difference measurement result, and places the result on the bus. The result is a power-based measurement and is expressed in the units defined by `UNIT[1]|2|3|4:POWer`.

The values shown in this query are those that are tested.

Parameters

Item	Range of values	Description/Default value
expected_value (for the expected power level)	sensor-dependent DEF ^[a]	The U2040 X-Series ignores the numeric value entered in this parameter. Any value entered is treated like DEF.
resolution	1 to 4 ^[b] 1.0, 0.1, 0.01, 0.001 DEF ^[a]	A numeric value for the resolution. If unspecified, the current resolution setting is used.
source_list	(@1),(@1)	This channel list specifies the channels used to calculate the difference. If unspecified and the current setup is a difference measurement, then this difference setup is used, otherwise it defaults to Channel A-A.

[a] The mnemonic DEF means DEFault. This is not equivalent to the DEFault parameter used in the command subsystems. The parameters must be entered in the specified order. If parameters are omitted, they default from the right. The parameter DEFault is used as a placeholder. Specifying DEF leaves the parameter value unchanged.

[b] When `SENS:AVER:COUN:AUTO` is enabled, the resolution setting affects the number of averages applied. Refer to “Auto-averaging mode” on page 44 for more information.

Example

```
MEAS2:DIFF?           Queries the CALCulate2 difference measurement.
```

MEASure[1]|2|3|4[:SCALAr][:POWer][:AC]:DIFFerence:RELative?

Syntax

```
MEASure[1]|2|3|4[:SCALAr][:POWer][:AC]:DIFFerence:RELative?
[<expected_value>[,<resolution>[,<source_list>]]]
```

Description

This query sets the specified CALCulate block measurement function to the difference mode with relative mode on, aborts, configures then initiates Channel A, calculates the difference measurement result, and places the result on the bus. The result is a ratio-based measurement and is expressed in the units defined by UNIT[1]|2|3|4:POWer:RATio. The relative value used is that set by the CALCulate:RELative:MAGNitude:AUTO command.

The values shown in this query are those that are tested.

Parameters

Item	Range of values	Description/Default value
expected_value (for the expected power level)	sensor-dependent DEF ^[a]	The U2040 X-Series ignores the numeric value entered in this parameter. Any value entered is treated like DEF.
resolution	1 to 4 ^[b] 1.0, 0.1, 0.01, 0.001 DEF ^[a]	A numeric value for the resolution. If unspecified, the current resolution setting is used.
source_list	(@1),(@1)	This channel list specifies the channels used to calculate the difference. If unspecified and the current setup is a difference measurement, then this difference setup is used, otherwise it defaults to Channel A-A.

[a] The mnemonic DEF means DEFault. This is not equivalent to the DEFault parameter used in the command subsystems. The parameters must be entered in the specified order. If parameters are omitted, they default from the right. The parameter DEFault is used as a placeholder. Specifying DEF leaves the parameter value unchanged.

[b] When SENS:AVER:COUN:AUTO is enabled, the resolution setting affects the number of averages applied. Refer to “Auto-averaging mode” on page 44 for more information.

Example

```
MEAS1:DIFF:REL? DEF,3,(@1),(@1)
```

Queries the CALCulate1 relative difference measurement of Channel A – Channel A, using the current range and a resolution setting of 3.

MEASure[1]|2|3|4[:SCALar][:POWer][:AC]:RATio?

Syntax

```
MEASure[1]|2|3|4[:SCALar][:POWer][:AC]:RATio?
[<expected_value>[,<resolution>[,<source_list>]]]
```

Description

This query sets the specified CALCulate block measurement function to the ratio mode with relative mode off, aborts, configures then initiates Channel A, calculates the ratio measurement result, and places the result on the bus. The result is a ratio-based measurement and is expressed in the units defined by UNIT[1]|2|3|4:POWer:RATio.

The values shown in this query are those that are tested.

Parameters

Item	Range of values	Description/Default value
expected_value (for the expected power level)	sensor-dependent DEF ^[a]	The U2040 X-Series ignores the numeric value entered in this parameter. Any value entered is treated like DEF.
resolution	1 to 4 ^[b] 1.0, 0.1, 0.01, 0.001 DEF ^[a]	A numeric value for the resolution. If unspecified, the current resolution setting is used.
source_list	(@1),(@1)	This channel list specifies the channels used to calculate the ratio. If unspecified and the current setup is a ratio measurement, then this ratio setup is used, otherwise it defaults to Channel A/A.

[a] The mnemonic DEF means DEFault. This is not equivalent to the DEFault parameter used in the command subsystems. The parameters must be entered in the specified order. If parameters are omitted, they default from the right. The parameter DEFault is used as a placeholder. Specifying DEF leaves the parameter value unchanged.

[b] When SENS:AVER:COUN:AUTO is enabled, the resolution setting affects the number of averages applied. Refer to "Auto-averaging mode" on page 44 for more information.

Example

```
MEAS2:RAT? DEF, 1, (@1), (@1)
```

Queries the CALCulate2 ratio measurement of Channel A over Channel A, using the current range and a resolution of 1.

MEASure[1]|2|3|4[:SCALAr][:POWer][:AC]:RATio:RELative?

Syntax

```
MEASure[1]|2|3|4[:SCALAr][:POWer][:AC]:RATio:RELative?
[<expected_value>[,<resolution>[,<source_list>]]]
```

Description

This query sets the specified `CALCulate` block measurement function to the ratio mode with relative mode on, aborts, configures then initiates Channel A, calculates the ratio measurement, and places the result on the bus. The result is a ratio-based measurement and is expressed in the units defined by `UNIT[1]|2|3|4:POWer:RATio`. The relative value used is that set by the `CALCulate:RELative:MAGNitude:AUTO` command.

The values shown in this query are those that are tested.

Parameters

Item	Range of values	Description/Default value
expected_value (for the expected power level)	sensor-dependent DEF ^[a]	The U2040 X-Series ignores the numeric value entered in this parameter. Any value entered is treated like DEF.
resolution	1 to 4 ^[b] 1.0, 0.1, 0.01, 0.001 DEF ^[a]	A numeric value for the resolution. If unspecified, the current resolution setting is used.
source_list	(@1),(@1)	This channel list specifies the channels used to calculate the ratio. If unspecified and the current setup is a ratio measurement, then this ratio setup is used, otherwise it defaults to Channel A/A.

[a] The mnemonic DEF means DEFault. This is not equivalent to the DEFault parameter used in the command subsystems. The parameters must be entered in the specified order. If parameters are omitted, they default from the right. The parameter DEFault is used as a placeholder. Specifying DEF leaves the parameter value unchanged.

[b] When `SENS:AVER:COUN:AUTO` is enabled, the resolution setting affects the number of averages applied. Refer to “Auto-averaging mode” on page 44 for more information.

Example

```
MEAS:RAT:REL?      Queries the CALCulate1 relative ratio measurement.
```

MEASure[1]|2|3|4[:SCALar][:POWer][:AC]:RELative?

Syntax

```
MEASure[1]|2|3|4[:SCALar][:POWer][:AC]:RELative?
[<expected_value>[,<resolution>[,<source_list>]]]
```

Description

This query sets the specified CALCulate block measurement function to single channel with relative mode on, aborts, configures then initiates the specified channel, calculates the measurement result, and places the result on the bus. The result is a ratio-based measurement and is expressed in the units defined by UNIT[1]|2|3|4:POWer:RATIo. The relative value used is that set by the CALCulate:RELative:MAGNitude:AUTO command.

The values shown in this query are those that are tested.

Parameters

Item	Range of values	Description/Default value
expected_value (for the expected power level)	sensor-dependent DEF ^[a]	A numeric value for the expected power level. The units of measurement are dBm and W. The default units are defined by UNIT:POWer.
resolution	1 to 4 ^[b] 1.0, 0.1, 0.01, 0.001 DEF ^[a]	A numeric value for the resolution. If unspecified, the current resolution setting is used.
source_list	(@1)	The channel which the command is implemented on. If unspecified, the current setup is used. If the ratio or difference measurement was set up, it will default to Channel A.

[a] The mnemonic DEF means DEFault. This is not equivalent to the DEFault parameter used in the command subsystems. The parameters must be entered in the specified order. If parameters are omitted, they default from the right. The parameter DEFault is used as a placeholder. Specifying DEF leaves the parameter value unchanged.

[b] When SENS:AVER:COUN:AUTO is enabled, the resolution setting affects the number of averages applied. Refer to “Auto-averaging mode” on page 44 for more information.

Example

```
MEAS1:REL? -10DBM,2,(@1)
```

Queries the CALCulate1 relative measurement of Channel A, using an expected power level of -10 dBm and a resolution setting of 2.

THIS PAGE HAS BEEN INTENTIONALLY LEFT BLANK.

Keysight U2040 X-Series
Wide Dynamic Range Power Sensors
Programming Guide

13 MEMory Subsystem

MEMory:CATalog:STATe?	166
MEMory:CATalog:TABLE?	167
MEMory:CATalog[:ALL]?	168
MEMory:CLEar:TABLE	169
MEMory:CLEar[:NAME]	170
MEMory:FREE:STATe?	171
MEMory:FREE:TABLE?	172
MEMory:FREE[:ALL]?	173
MEMory:NSTates?	174
MEMory:NTABLEs?	175
MEMory:STATe:CATalog?	176
MEMory:STATe:DEFine	177
MEMory:TABLE:FREQuency	178
MEMory:TABLE:FREQuency:POINts?	180
MEMory:TABLE:MOVE	181
MEMory:TABLE:GAIN[:MAGNitude]	182
MEMory:TABLE:GAIN[:MAGNitude]:POINts?	184
MEMory:TABLE:SElect	185
MEMory:TABLE:SGAMma	186
MEMory:TABLE:SGAMma:POINts?	187
MEMory:TABLE:SPARam	188
MEMory:TABLE:SPARam:POINts?	189

This chapter describes the MEMory subsystem commands.

MEMory:CATalog:STATe?

Syntax

```
MEMory:CATalog:STATe?
```

Description

This query is used to list the save/recall registers.

The U2040 X-Series returns the data in the form of two numeric parameters and as many strings as there are save/recall registers.

```
<numeric_value>,<numeric_value>{,<string>}
```

- The first numeric parameter indicates the amount of memory, in bytes, used for the storage of registers.
- The second parameter indicates the memory, in bytes, available for the storage of registers.
- Each string parameter returned indicates the name, type, and size of a save/recall register:

```
<string>,<type>,<size>
```

- <string> indicates the name of the save/recall register.
- <type> indicates STAT for the save/recall register.
- <size> indicates the size of the save/recall register in bytes.

For example, a sample response may look like:

```
0,24800,"State1,STAT,0","State2,STAT,0","State3,STAT,0","State4,STAT,0","State5,STAT,0","State6,STAT,0","State7,STAT,0","State8,STAT,0","State9,STAT,0","State10,STAT,0"
```

Example

```
MEM:CAT:STAT?
```

Queries the list of save/recall registers.

MEMory:CATalog:TABLE?

Syntax

```
MEMory:CATalog:TABLE?
```

Description

This query is used to list the stored frequency-dependent offset, gamma, and S-parameter tables.

The U2040 X-Series returns the data in the form of two numeric parameters and as many strings as there are stored tables.

```
<numeric_value>,<numeric_value>{,<string>}
```

- The first numeric parameter indicates the amount of memory, in bytes, used for the storage of tables.
- The second parameter indicates the memory, in bytes, available for the storage of tables.
- Each string parameter returned indicates the name, type, and size of a stored table:

```
<string>,<type>,<size>
```

- <string> indicates the name of the table.
- <type> indicates TABL for a table.
- <size> indicates the size of the table in bytes.

For example, a sample response may look like:

```
0,933460,"CUSTOM_A,TABL,0","CUSTOM_B,TABL,0","CUSTOM_C,TABL,0","C
USTOM_D,TABL,0","CUSTOM_E,TABL,0","CUSTOM_F,TABL,0","CUSTOM_G,TAB
L,0","CUSTOM_H,TABL,0","CUSTOM_I,TABL,0","CUSTOM_J,TABL,0","Gamma
1,TABL,0","Gamma2,TABL,0","Gamma3,TABL,0","Gamma4,TABL,0","Gamma5
,TABL,0","Gamma6,TABL,0","Gamma7,TABL,0","Gamma8,TABL,0","Gamma9,
TABL,0","Gamma10,TABL,0","SParam1,TABL,0","SParam2,TABL,0","SPara
m3,TABL,0","SParam4,TABL,0","SParam5,TABL,0","SParam6,TABL,0","SP
aram7,TABL,0","SParam8,TABL,0","SParam9,TABL,0","SParam10,TABL,0"
```

Example

```
MEM:CAT:TABLE?
```

Queries the list of stored tables.

MEMory:CATalog[:ALL]?

Syntax

```
MEMory:CATalog[:ALL]?
```

Description

This query lists the stored frequency-dependent offset, gamma, and S-parameter tables and save/recall registers.

The U2040 X-Series returns the data in the form of two numeric parameters and as many strings as there are stored tables and save/recall registers:

```
<numeric_value>,<numeric_value>{,<string>}
```

- The first numeric parameter indicates the amount of memory, in bytes, used for the storage of tables and registers.
- The second numeric parameter indicates the memory, in bytes, available for the storage of tables and registers.
- Each string parameter returned indicates the name, type, and size of a stored table or save/recall register:

```
<string>,<type>,<size>
```

- <string> indicates the name of the table or save/recall register.
- <type> indicates TABL for calibration and frequency-dependent offset tables, or STAT for a save/recall register.
- <size> indicates the size of the table or save/recall register in bytes.

A sample response may look like the following:

```
0,958260,"CUSTOM_A,TABL,0","CUSTOM_B,TABL,0","CUSTOM_C,TABL,0","C
USTOM_D,TABL,0","CUSTOM_E,TABL,0","CUSTOM_F,TABL,0","CUSTOM_G,TAB
L,0","CUSTOM_H,TABL,0","CUSTOM_I,TABL,0","CUSTOM_J,TABL,0","Gamma
1,TABL,0","Gamma2,TABL,0","Gamma3,TABL,0","Gamma4,TABL,0","Gamma5
,TABL,0","Gamma6,TABL,0","Gamma7,TABL,0","Gamma8,TABL,0","Gamma9,
TABL,0","Gamma10,TABL,0","SParam1,TABL,0","SParam2,TABL,0","SPara
m3,TABL,0","SParam4,TABL,0","SParam5,TABL,0","SParam6,TABL,0","SP
aram7,TABL,0","SParam8,TABL,0","SParam9,TABL,0","SParam10,TABL,0"
,"State1,STAT,0","State2,STAT,0","State3,STAT,0","State4,STAT,0",
"State5,STAT,0","State6,STAT,0","State7,STAT,0","State8,STAT,0",
"State9,STAT,0","State10,STAT,0"
```

Example

```
MEM:CAT?
```

Queries the list of tables and save/recall registers.

MEMory:CLEar:TABLE

Syntax

```
MEMory:CLEar:TABLE
```

Description

This command is used to clear the contents of the table currently selected using `MEMory:TABLE:SElect`. Although the table remains, a `MEMory:TABLE:FREQuency:POINts?` query returns a 0 as the table contents are empty.

This command is an alternative form of the `MEMory:CLEar[:NAME]` command. The difference is the method in which the table is selected.

NOTE

The contents cleared using this command are non-recoverable.

Example

```
MEM:CLE:TABL      Clears the contents of the currently selected table.
```

Error message

If no table is selected, error -221, "Settings conflict" occurs.

MEMory:CLEar[:NAME]

Syntax

```
MEMory:CLEar[:NAME] <character_data>
```

Description

This command clears the contents stored in frequency-dependent offset, gamma, and S-parameter tables and save/recall registers. This command removes the data contents but does not affect the name of the associated table or save/recall register.

Although the table remains, a `MEMory:TABLE:FREQUENCY:POINTS?` query returns a 0 as there are no contents in the table.

For frequency-dependent offset tables, this command is an alternative form of the `MEMory:CLEar:TABLE` command, the only difference being the method in which the table is selected.

NOTE

The contents cleared using this command are non-recoverable.

Parameter

Item	Range of values	Description/Default value
<code>character_data</code>	Any existing table name or save/recall register.	Contains an existing table name or save/recall register.

Example

```
MEM:CLE "TABLE1"           Clears the contents of frequency-dependent offset table
                             "TABLE1".
```

Error message

If the table or save/recall register name does not exist, error -224, "Illegal parameter value" occurs.

MEMory:FREE:STATe?

Syntax

```
MEMory:FREE:STATe?
```

Description

This query returns the amount of memory free for save/recall registers.

The format of the response is:

```
<bytes_available>,<bytes_in_use>
```

Example

```
MEM:FREE:STAT?    Queries the amount of free memory for save/recall registers.
```

MEMory:FREE:TABLE?

Syntax

```
MEMory:FREE:TABLE?
```

Description

This query returns the amount of memory free for frequency-dependent offset tables, gamma tables, and S-parameter tables. The format of the response is:

```
<bytes_available>,<bytes_in_use>
```

Example

```
MEM:FREE:TABLE?
```

Queries the amount of free memory for tables.

MEMory:FREE[:ALL]?

Syntax

```
MEMory:FREE[:ALL]?
```

Description

This query returns the amount of memory free for frequency-dependent offset tables, gamma tables, S-parameter tables, and save/recall registers. The format of the response is:

```
<bytes_available>,<bytes_in_use>
```

Example

```
MEM:FREE?           Queries the amount of free memory in total.
```

MEMory:NSTates?

Syntax

```
MEMory:NSTates?
```

Description

This query returns the number of registers that are available for save/recall. As there are 10 registers, this query always returns 10.

Example

```
MEM:NST?           Queries the number of registers available for save/recall.
```

MEMory:NTABLEs?

Syntax

```
MEMory:NTABLEs? FDOFfset | SGAMma | SPARAm
```

Description

This query returns the number of available frequency-dependent offset, gamma, or S-parameter tables.

Parameter

Item	Range of values	Description/Default value
character_data	FDOFfset SGAMma SPARAm	Specifies the table type: - FDOFfset: Frequency-dependent offset - SGAMma: Gamma - SPARAm: S-parameter

Example

```
MEM:NTAB? FDOF
```

Queries the number of available frequency-dependent offset tables.

MEMory:STATe:CATalog?

Syntax

```
MEMory:STATe:CATalog?
```

Description

This query returns a list of the save/recall register names in ascending order of register number. The format of the response is:

```
<string>,<string>,. . . .,<string>
```

Example

```
MEM:STAT:CAT?
```

Queries the register names.

MEMory:STATe:DEFine

Syntax

```
MEMory:STATe:DEFine <character_data>,<numeric_value>
MEMory:STATe:DEFine? <string>
```

Description

This command is used to associate a name with a save/recall register number.

The query returns the register number for the given register name.

Parameters

Item	Range of values	Description/Default value
character_data	A to Z (upper-case) a to z (lower-case) 0 to 9 _ (underscore)	Details the register name. A maximum of 12 characters can be used.
numeric_value	1 to 10	A numeric value (<NR.F>) for the register number.

Example

```
MEM:STAT:DEF "SETUP1",4    Names register 4 "SETUP1".
```

Error messages

- If the register number is out of range, error -222, "Data out of range" occurs.
- If the name is invalid, error -224, "Illegal parameter value" occurs.
- If a register with the same name already exists, error -257, "File name error" occurs (command only).

MEMory:TABLE:FREQuency

Syntax

```
MEMory:TABLE:FREQuency <numeric_value>{,<numeric_value>}
MEMory:TABLE:FREQuency?
```

Description

This command is used to enter frequency data into the current selected table. Any previous frequency list is cleared before the new frequency list is stored. The frequencies must be entered in ascending order. Entries in the frequency lists correspond with entries in the offset factor, gamma, or S-parameter lists.

Ensure that the frequency points you use cover the frequency range of the signals that you want to measure. If you measure a signal with a frequency outside the frequency range defined in the table, then the U2040 X-Series uses the highest or lowest point in the table to calculate the value.

Depending on available memory, the U2040 X-Series is capable of storing 10 frequency-dependent offset tables (containing 512 frequency points each), 10 gamma tables (containing 1024 frequency points each), and 10 S-parameter tables (containing 1024 frequency points each).

The query returns a list of frequency points for the currently selected table. The frequencies are returned in Hz.

Parameter

Item	Range of values	Description/Default value
numeric_value	1 kHz to 1000.0 GHz ^[a] ^[b]	A numeric value for the frequency. The default unit is Hz.

[a] The following measurement units can be used:

Hz

kHz (10^3)

MHz (10^6)

GHz (10^9)

[b] All frequencies are truncated to a multiple of 1 kHz.

Example

`MEM:TABLE:FREQ 200kHz,600kHz` Enters frequencies of 200 kHz and 600 kHz into the currently selected table.

Error messages

- If more than 512 frequencies (for frequency-dependent offset) and 1024 frequencies (for gamma/S-parameter) are in the list, error -108, "Parameter not allowed" occurs.
- If the frequencies are not entered in ascending order, error -220, "Parameter error; Frequency list must be in ascending order" occurs.
- If a table has not been specified using the `MEMory:TABLE:SELEct` command, the data cannot be entered into the table and error -221, "Settings conflict" occurs.
- If a frequency is sent which is outside of the allowed frequency range, error -222, "Data out of range" occurs.

MEMory:TABLE:FREQuency:POINts?

Syntax

```
MEMory:TABLE:FREQuency:POINts?
```

Description

This query returns the number of frequency points for the currently selected table. The response format is <NRf>. If no frequency values have been set, this command returns 0. If no table is selected, this command returns NAN.

Example

```
MEM:TABLE:FREQ:POIN?
```

Queries the number of frequency points in the current table.

MEMory:TABLE:MOVE

Syntax

```
MEMory:TABLE:MOVE <character_data>,<character_data>
```

Description

This command is used to rename a frequency-dependent offset, gamma, or S-parameter table.

Parameters

Item	Range of values	Description/Default value
character_data (1st parameter)	Existing table name	Contains the existing table name.
character_data (2nd parameter)	A to Z (upper-case) a to z (lower-case) 0 to 9 _ (underscore)	Details the new table name. A maximum of 12 characters can be used.

Example

```
MEM:TABLE:MOVE "tab1","tab1a"    Renames a table named "tab1" to "tab1a".
```

Error messages

- If either table name is invalid, error –224, “Illegal parameter value” occurs.
- If the first parameter does not match an existing table name, error –256, “File name not found” occurs.
- If the second parameter matches an existing table name or save/recall register, error –257, “File name error” occurs.

MEMory:TABLE:GAIN[:MAGNitude]

Syntax

```
MEMory:TABLE:GAIN[:MAGNitude] <numeric_value>{,<numeric_value>}
MEMory:TABLE:GAIN[:MAGNitude]?
```

Description

This command is used to enter offsets into the frequency-dependent offset table, currently selected using `MEMory:TABLE:SELect`. Any previous offset list is cleared before the new offsets are stored.

A maximum of 512 parameters for frequency-dependent offset tables can be sent with this command.

Entries in the frequency lists correspond (as shown in **Table 13-1**) with entries in the offset factor lists.

The query returns a list of offset points for the currently selected table.

Table 13-1 Frequency and offset factor list

Frequency	Offset
Frequency 1	Offset 1
"	"
Frequency 512	Offset 512

Parameter

Item	Range of values	Description/Default value
numeric_value	1.0 to 150.0	A numeric value for the offset factors. The unit is PCT.

Example

```
MEM:TABLE:SEL "Table_1"
```

```
MEM:TABLE:GAIN 97,99.5,97.4
```

Enters offset factors of 97%, 99.5%, and 97.4% into the frequency-dependent offset table.

Error messages

- If more than 512 offsets for frequency-dependent offset tables are in the list, error –108, “Parameter not allowed” occurs.
- If a table is not specified using the `MEMory:TABLE:SElect` command, the data cannot be entered and error –221, “Settings conflict” occurs.
- If any of the offset factors are outside of the allowed range, error –222, “Data out of range” occurs.

MEMory:TABLE:GAIN[:MAGNitude]:POINTs?

Syntax

```
MEMory:TABLE:GAIN[:MAGNitude]:POINTs?
```

Description

This query is used to return the number of offset points for the currently selected table. If no values have been set, 0 is returned. If no table is selected, NAN is returned.

Example

```
MEM:TABLE:GAIN:POIN?      Queries the number of offset points in the current table.
```

MEMory:TABLE:SElect

Syntax

```
MEMory:TABLE:SElect <character_data>
MEMory:TABLE:SElect?
```

Description

This command is used to activate a frequency-dependent offset, gamma, or S-parameter table. A table must be activated before any operation can be performed on it.

The query returns the name of the currently selected table.

Parameter

Item	Range of values	Description/Default value
character_data	A to Z (upper-case) a to z (lower-case) 0 to 9 _ (underscore)	Details the new table name. A maximum of 12 characters can be used.

Example

```
MEM:TABLE:SEL "Table1"    Selects a frequency-dependent offset table named "Table1".
```

Error message

If the table name is invalid, error -224, "Illegal parameter value" occurs.

MEMory:TABLE:SGAMma

Syntax

```
MEMory:TABLE:SGAMma
<numeric_value>,<numeric_value>{,<numeric_value>}{,<numeric_value>}
MEMory:TABLE:SGAMma?
```

Description

This command sets the magnitude-phase pairs for the source gamma for the currently selected gamma table. A gamma table needs to be selected before this command can be used. The maximum number of magnitude-phase pairs is 1024.

The query returns a list of magnitude-phase pairs for the currently selected gamma table.

Parameter

Item	Range of values	Description/Default value
numeric_value	Magnitude: 0.0 to 0.999 Phase: $-180.0^\circ \leq p < +180.0^\circ$	Sets the magnitude-phase pair values.

Example

```
MEM:TABLE:SGAM 1.0,160,0.45,60
```

This command sets the magnitude-phase pairs as 1.0 (mag1), 160 (phase1), 0.45 (mag2), and 60 (phase2).

Error messages

- If more than 1024 magnitude-phase pairs for gamma values are in the list, error -108, "Parameter not allowed" occurs.
- If a table is not specified using the MEMory:TABLE:SELEct command, the data cannot be entered and error -221, "Settings conflict" occurs.
- If any of the magnitude or phase values are outside of the allowed range, error -222, "Data out of range" occurs.

MEMory:TABLE:SGAMma:POINts?

Syntax

```
MEMory:TABLE:SGAMma:POINts?
```

Description

This query is used to list the number of magnitude-phase pairs for the source gamma for the currently selected gamma table.

If no magnitude-phase values have been set, this query returns a 0.

If no table is selected, this query returns NAN.

Example

```
MEM:TABLE:SGAM:POIN?
```

Queries the number of magnitude-phase pairs for the currently selected gamma table.

MEMory:TABLE:SPARam

Syntax

```
MEMory:TABLE:SPARam
<S11|S12|S21|S22>,<numeric_value>,<numeric_value>{,<numeric_value>}
{,<numeric_value>}
MEMory:TABLE:SPARam? S11|S12|S21|S22
```

Description

This command sets the magnitude-phase pairs for the selected S-parameter type for the currently selected S-parameter table. The maximum number of magnitude-phase pairs is 1024.

The query returns a list of magnitude-phase pairs for the currently selected S-parameter table.

Parameter

Item	Range of values	Description/Default value
numeric_value	For S11, S22 - Magnitude: (0.0 to 0.999) - Phase: ($-180.0^\circ \leq \rho < +180.0^\circ$) For S12, S21 - Magnitude: (1.0×10^{-5} to 1.0×10^5) - Phase: ($-180.0^\circ \leq \rho < +180.0^\circ$)	Sets the magnitude-phase pair values.

Example

```
MEM:TABLE:SPAR S11,0.3,100
```

This command sets the values 0.3 and 100 as a magnitude-phase pair for the S11 S-parameter.

Error messages

- If more than 1024 magnitude-phase pairs for S-parameter values are in the list, error -108, "Parameter not allowed" occurs.
- If a table is not specified using the MEMory:TABLE:SELeCt command, the data cannot be entered and error -221, "Settings conflict" occurs.
- If any of the magnitude or phase values are outside of the allowed range, error -222, "Data out of range" occurs.

MEMory:TABLE:SPARam:POINts?

Syntax

```
MEMory:TABLE:SPARam:POINts? S11|S12|S21|S22
```

Description

This query is used to list the number of magnitude-phase pairs for the selected S-parameter for the currently selected S-parameter table.

If no magnitude-phase values have been set, this query returns a 0.

If no table is selected, this query returns NAN.

Example

```
MEM:TABLE:SPAR:POIN? S11
```

Queries the number of S11 magnitude-phase pairs for the currently selected S-parameter table.

THIS PAGE HAS BEEN INTENTIONALLY LEFT BLANK.

Keysight U2040 X-Series
Wide Dynamic Range Power Sensors
Programming Guide

14 OUTPut Subsystem

OUTPut:TRIGger[1][:STATe] **192**

This chapter describes the OUTPut subsystem commands.

OUTPut:TRIGger[1][:STATe]

Syntax

```
OUTPut:TRIGger[1][:STATe] ON|OFF|1|0
OUTPut:TRIGger[1][:STATe]?
```

Description

This command enables or disables the trigger output signal.

The query indicates whether or not the trigger output signal is enabled or disabled.

- 1 is returned when the trigger output signal is enabled
- 0 is returned when the trigger output signal is disabled

NOTE

The `SERVICE:BIST:TBASE:STATE` command overrides the `OUTPut:TRIGger[1][:STATe]` command.

For example, if `OUTPut:TRIGger[1][:STATe]` is ON and the command `SERVICE:BIST:TBASE:STATE ON` is sent, this command overrides the trigger state and sets it to OFF.

If `SERVICE:BIST:TBASE:STATE` is ON and `OUTPut:TRIGger[1][:STATe] ON` is sent, the channel trigger output is now routed to the Trig Out port overriding the 10 MHz timebase signal output command and turning it off.

Example

```
OUTP:TRIG 1           Enables the trigger output signal.
```

Reset condition

On reset, the trigger output signal is disabled.

Error message

The trigger output signal can be enabled in any trigger source except for the bus trigger source. If the trigger source is set to bus, error -221, "Settings conflict" occurs.

Keysight U2040 X-Series
Wide Dynamic Range Power Sensors
Programming Guide

15 READ Subsystem

READ[1] 2 3 4[:SCALar][:POWer][:AC]? 194
READ[1] 2 3 4[:SCALar][:POWer][:AC]:DIFFerence? 196
READ[1] 2 3 4[:SCALar][:POWer][:AC]:DIFFerence:RELative? 198
READ[1] 2 3 4[:SCALar][:POWer][:AC]:RATio? 200
READ[1] 2 3 4[:SCALar][:POWer][:AC]:RATio:RELative? 202
READ[1] 2 3 4[:SCALar][:POWer][:AC]:RELative? 204

This chapter describes the READ subsystem commands.

READ[1]|2|3|4[:SCALar][:POWer][:AC]?

Syntax

```
READ[1]|2|3|4[:SCALar][:POWer][:AC]?
[<expected_value>[,<resolution>[,<source_list>]]]
```

Description

This query sets the specified CALCulate block measurement function to single channel with relative mode off, aborts then initiates the specified channel, calculates the measurement result, and places the result on the bus. The result is a power-based measurement and is expressed in the units defined by UNIT[1]|2|3|4:POWer.

NOTE

INITiate:CONTinuous must be set to OFF, otherwise error -213, "INIT ignored" occurs. If TRIGger:SOURce is set to BUS, error -214, "Trigger deadlock" occurs.

Parameters

Item	Range of values	Description/Default value
expected_value (for the expected power level)	sensor-dependent DEF ^[a]	The expected power level parameter can be set to DEF or a numeric value. If a value is entered, it should correspond to that set by CONFigure otherwise an error occurs.
resolution	1 to 4 ^[b] 1.0, 0.1, 0.01, 0.001 DEF ^[a]	A numeric value for the resolution. If it is unspecified, the current resolution setting is used. If a value is entered, it should correspond to the current resolution setting otherwise an error occurs.
source_list	(@1)	The channel which the command is implemented on. If unspecified, the current setup is used. If the ratio or difference measurement was set up, it will default to Channel A.

[a] The mnemonic DEF means DEFault. This is not equivalent to the DEFault parameter used in the command subsystems. The parameters must be entered in the specified order. If parameters are omitted, they default from the right. The parameter DEFault is used as a placeholder. Specifying DEF leaves the parameter value unchanged.

[b] When SENS:AVER:COUN:AUTO is enabled, the resolution setting affects the number of averages applied. Refer to "Auto-averaging mode" on page 44 for more information.

Example

```
READ2:POW:AC?      Queries the CALCulate2 measurement.
```

Error messages

- `INITiate:CONTInuous` must be set to `OFF`, otherwise error -213, "INIT ignored" occurs.
- If `TRIGger:SOURce` is set to `BUS` or `HOLD`, error -214, "Trigger deadlock" occurs.
- If the expected value and resolution parameters are not the same as the current expected value and resolution settings on the specified `CALCuLate` block, error -221, "Settings conflict" occurs.

READ[1]|2|3|4[:SCALAr][:POWer][:AC]:DIFFerence?

Syntax

```
READ[1]|2|3|4[:SCALAr][:POWer][:AC]:DIFFerence?
[<expected_value>[,<resolution>[,<source_list>]]]
```

Description

This query sets the specified `CALCulate` block measurement function to the difference mode with relative mode off, aborts then initiates Channel A, calculates the difference measurement result, and places the result on the bus. The result is a power-based measurement and is expressed in the units defined by `UNIT[1]|2|3|4:POWer`.

NOTE

`INITiate:CONTinuous` must be set to `OFF`, otherwise error -213, "INIT ignored" occurs. If `TRIGger:SOURce` is set to `BUS`, error -214, "Trigger deadlock" occurs.

Parameters

Item	Range of values	Description/Default value
expected_value (for the expected power level)	sensor-dependent DEF ^[a]	The U2040 X-Series ignores the numeric value entered in this parameter. Any value entered is treated like DEF.
resolution	1 to 4 ^[b] 1.0, 0.1, 0.01, 0.001 DEF ^[a]	A numeric value for the resolution. If it is unspecified, the current resolution setting is used. If a value is entered, it should correspond to the current resolution setting otherwise an error occurs.
source_list	(@1),(@1)	This channel list specifies the channels used to calculate the difference. If unspecified and the current setup is a difference measurement, then this difference setup is used, otherwise it defaults to Channel A-A.

[a] The mnemonic `DEF` means `DEFault`. This is not equivalent to the `DEFault` parameter used in the command subsystems. The parameters must be entered in the specified order. If parameters are omitted, they default from the right. The parameter `DEFault` is used as a placeholder. Specifying `DEF` leaves the parameter value unchanged.

[b] When `SENS:AVER:COUN:AUTO` is enabled, the resolution setting affects the number of averages applied. Refer to "Auto-averaging mode" on page 44 for more information.

Example

```
READ2:DIFF?           Queries the CALCulate2 difference measurement.
```

Error messages

- `INITiate:CONTInuous` must be set to `OFF`, otherwise error -213, "INIT ignored" occurs.
- If `TRIGger:SOURce` is set to `BUS` or `HOLD`, error -214, "Trigger deadlock" occurs.
- If the resolution parameter is not the same as the current resolution setting on the specified `CALCulate` block, error -221, "Settings conflict" occurs.

READ[1]|2|3|4[:SCALar][:POWer][:AC]:DIFFerence:RELative?

Syntax

```
READ[1]|2|3|4[:SCALar][:POWer][:AC]:DIFFerence:RELative?
[<expected_value>[,<resolution>[,<source_list>]]]
```

Description

This query sets the specified CALCulate block measurement function to the difference mode with relative mode on, aborts then initiates Channel A, calculates the difference measurement result, and places the result on the bus. The result is a ratio-based measurement and is expressed in the units defined by UNIT[1]|2|3|4:POWer:RATio. The relative value used is that set by the CALCulate:RELative:MAGNitude:AUTO command.

NOTE

INITiate:CONTinuous must be set to OFF, otherwise error -213, “INIT ignored” occurs. If TRIGger:SOURce is set to BUS, error -214, “Trigger deadlock” occurs.

Parameters

Item	Range of values	Description/Default value
expected_value (for the expected power level)	sensor-dependent DEF ^[a]	The U2040 X-Series ignores the numeric value entered in this parameter. Any value entered is treated like DEF.
resolution	1 to 4 ^[b] 1.0, 0.1, 0.01, 0.001 DEF ^[a]	A numeric value for the resolution. If it is unspecified, the current resolution setting is used. If a value is entered, it should correspond to the current resolution setting otherwise an error occurs.
source_list	(@1),(@1)	This channel list specifies the channels used to calculate the difference. If unspecified and the current setup is a difference measurement, then this difference setup is used, otherwise it defaults to Channel A-A.

[a] The mnemonic DEF means DEFault. This is not equivalent to the DEFault parameter used in the command subsystems. The parameters must be entered in the specified order. If parameters are omitted, they default from the right. The parameter DEFault is used as a placeholder. Specifying DEF leaves the parameter value unchanged.

[b] When SENS:AVER:COUN:AUTO is enabled, the resolution setting affects the number of averages applied. Refer to “Auto-averaging mode” on page 44 for more information.

Example

```
READ1:DIFF:REL? DEF,4,(@1),(@1)
```

Queries the CALCulate1 relative difference measurement of Channel A – Channel A, using the current range and a resolution setting of 4.

Error messages

- INITiate:CONTInuous must be set to OFF, otherwise error -213, “INIT ignored” occurs.
- If TRIGger:SOURce is set to BUS or HOLD, error -214, “Trigger deadlock” occurs.
- If the resolution parameter is not the same as the current resolution setting on the specified CALCulate block, error -221, “Settings conflict” occurs.

READ[1]|2|3|4[:SCALAr][:POWer][:AC]:RATio?

Syntax

```
READ[1]|2|3|4[:SCALAr][:POWer][:AC]:RATio?
[<expected_value>[,<resolution>[,<source_list>]]]
```

Description

This query sets the specified CALCulate block measurement function to the ratio mode with relative mode off, aborts then initiates Channel A, calculates the ratio measurement result, and places the result on the bus. The result is a ratio-based measurement and is expressed in the units defined by UNIT[1]|2|3|4:POWer:RATio.

NOTE

INITiate:CONTinuous must be set to OFF, otherwise error -213, "INIT ignored" occurs. If TRIGger:SOURce is set to BUS, error -214, "Trigger deadlock" occurs.

Parameters

Item	Range of values	Description/Default value
expected_value (for the expected power level)	sensor-dependent DEF ^[a]	The U2040 X-Series ignores the numeric value entered in this parameter. Any value entered is treated like DEF.
resolution	1 to 4 ^[b] 1.0, 0.1, 0.01, 0.001 DEF ^[a]	A numeric value for the resolution. If it is unspecified, the current resolution setting is used. If a value is entered, it should correspond to the current resolution setting otherwise an error occurs.
source_list	(@1),(@1)	This channel list specifies the channels used to calculate the ratio. If unspecified and the current setup is a ratio measurement, then this ratio setup is used, otherwise it defaults to Channel A/A.

[a] The mnemonic DEF means DEFault. This is not equivalent to the DEFault parameter used in the command subsystems. The parameters must be entered in the specified order. If parameters are omitted, they default from the right. The parameter DEFault is used as a placeholder. Specifying DEF leaves the parameter value unchanged.

[b] When SENS:AVER:COUN:AUTO is enabled, the resolution setting affects the number of averages applied. Refer to "Auto-averaging mode" on page 44 for more information.

Example

```
READ2:RAT? DEF,1,(@1),(@1)
```

Queries the CALCulate2 ratio measurement of Channel A over Channel A, using the current range and a resolution of 1.

Error messages

- INITiate:CONTInuous must be set to OFF, otherwise error -213, "INIT ignored" occurs.
- If TRIGger:SOURce is set to BUS or HOLD, error -214, "Trigger deadlock" occurs.
- If the resolution parameter is not the same as the current resolution setting on the specified CALCulate block, error -221, "Settings conflict" occurs.

READ[1]|2|3|4[:SCALAr][:POWer][:AC]:RATio:RELative?

Syntax

```
READ[1]|2|3|4[:SCALAr][:POWer][:AC]:RATio:RELative?
[<expected_value>[,<resolution>[,<source_list>]]]
```

Description

This query sets the specified `CALCulate` block measurement function to the ratio mode with relative mode on, aborts then initiates Channel A, calculates the ratio measurement result using the new data, and places the result on the bus. The result is a ratio-based measurement and is expressed in the units defined by `UNIT[1]|2|3|4:POWer:RATio`. The relative value used is that set by the `CALCulate:RELative:MAGNitude:AUTO` command.

NOTE

`INITiate:CONTInuous` must be set to `OFF`, otherwise error -213, "INIT ignored" occurs. If `TRIGger:SOURce` is set to `BUS`, error -214, "Trigger deadlock" occurs.

Parameters

Item	Range of values	Description/Default value
expected_value (for the expected power level)	sensor-dependent DEF ^[a]	The U2040 X-Series ignores the numeric value entered in this parameter. Any value entered is treated like <code>DEF</code> .
resolution	1 to 4 ^[b] 1.0, 0.1, 0.01, 0.001 DEF ^[a]	A numeric value for the resolution. If it is unspecified, the current resolution setting is used. If a value is entered, it should correspond to the current resolution setting otherwise an error occurs.
source_list	(@1),(@1)	This channel list specifies the channels used to calculate the ratio. If unspecified and the current setup is a ratio measurement, then this ratio setup is used, otherwise it defaults to Channel A/A.

[a] The mnemonic `DEF` means `DEFault`. This is not equivalent to the `DEFault` parameter used in the command subsystems. The parameters must be entered in the specified order. If parameters are omitted, they default from the right. The parameter `DEFault` is used as a placeholder. Specifying `DEF` leaves the parameter value unchanged.

[b] When `SENS:AVER:COUN:AUTO` is enabled, the resolution setting affects the number of averages applied. Refer to "Auto-averaging mode" on page 44 for more information.

Example

```
READ:RAT:REL?           Queries the CALCulate1 relative ratio measurement.
```

Error messages

- `INITiate:CONTinuous` must be set to `OFF`, otherwise error -213, "INIT ignored" occurs.
- If `TRIGger:SOURce` is set to `BUS` or `HOLD`, error -214, "Trigger deadlock" occurs.
- If the resolution parameter is not the same as the current resolution setting on the specified `CALCulate` block, error -221, "Settings conflict" occurs.

READ[1]|2|3|4[:SCALAr][:POWer][:AC]:RELative?

Syntax

```
READ[1]|2|3|4[:SCALAr][:POWer][:AC]:RELative?
[<expected_value>[,<resolution>[,<source_list>]]]
```

Description

This query sets the specified CALCulate block measurement function to single channel with relative mode on, aborts then initiates the specified channel, calculates the measurement result, and places the result on the bus. The result is a ratio-based measurement and is expressed in the units defined by UNIT[1]|2|3|4:POWer:RATIo. The relative value used is that set by the CALCulate:RELative:MAGNitude:AUTO command.

NOTE

INITiate:CONTInuous must be set to OFF, otherwise error -213, “INIT ignored” occurs. If TRIGger:SOURce is set to BUS, error -214, “Trigger deadlock” occurs.

Parameters

Item	Range of values	Description/Default value
expected_value (for the expected power level)	sensor-dependent DEF ^[a]	The expected power level parameter can be set to DEF or a numeric value. If a value is entered, it should correspond to that set by CONFigure otherwise an error occurs.
resolution	1 to 4 ^[b] 1.0, 0.1, 0.01, 0.001 DEF ^[a]	A numeric value for the resolution. If it is unspecified, the current resolution setting is used. If a value is entered, it should correspond to the current resolution setting otherwise an error occurs.
source_list	(@1)	The channel which the command is implemented on. If unspecified, the current setup is used. If the ratio or difference measurement was set up, it will default to Channel A.

[a] The mnemonic DEF means DEFault. This is not equivalent to the DEFault parameter used in the command subsystems. The parameters must be entered in the specified order. If parameters are omitted, they default from the right. The parameter DEFault is used as a placeholder. Specifying DEF leaves the parameter value unchanged.

[b] When SENS:AVER:COUN:AUTO is enabled, the resolution setting affects the number of averages applied. Refer to “Auto-averaging mode” on page 44 for more information.

Example

```
READ:REL? DEF,1,(@1)
```

Queries the CALCulate1 relative measurement of Channel A, using the current range and a resolution of 1.

Error messages

- `INITiate:CONTInuous` must be set to `OFF`, otherwise error -213, "INIT ignored" occurs.
- If `TRIGger:SOURce` is set to `BUS` or `HOLD`, error -214, "Trigger deadlock" occurs.
- If the expected value and resolution parameters are not the same as the current expected value and resolution settings on the specified `CALCulate` block, error -221, "Settings conflict" occurs.

THIS PAGE HAS BEEN INTENTIONALLY LEFT BLANK.

Keysight U2040 X-Series

Wide Dynamic Range Power Sensors

Programming Guide

16 SENSE Subsystem

[.:SENSE[1]:]AVERAge2:COUNT	209
[.:SENSE[1]:]AVERAge2[:STATe]	210
[.:SENSE[1]:]AVERAge:COUNT	211
[.:SENSE[1]:]AVERAge:COUNT:AUTO	213
[.:SENSE[1]:]AVERAge:RESet	215
[.:SENSE[1]:]AVERAge:SDETect	216
[.:SENSE[1]:]AVERAge[:STATe]	217
[.:SENSE[1]:]BANDwidth BWIDth:VIDeo	218
[.:SENSE[1]:]BANDwidth BWIDth:VIDeo:STATe	219
[.:SENSE[1]:]BUFFer:COUNT	220
[.:SENSE[1]:]BUFFer:MTYPe	221
[.:SENSE[1]:]CORRection:CSET2:STATe	222
[.:SENSE[1]:]CORRection:CSET3:STATe	223
[.:SENSE[1]:]CORRection:CSET4:STATe	224
[.:SENSE[1]:]CORRection:CSET2[:SElect]	225
[.:SENSE[1]:]CORRection:CSET3[:SElect]	227
[.:SENSE[1]:]CORRection:CSET4[:SElect]	228
[.:SENSE[1]:]CORRection:DCYClE GAIN3:STATe	229
[.:SENSE[1]:]CORRection:DCYClE GAIN3[:INPut][:MAGNitude]	230
[.:SENSE[1]:]CORRection:FDOFFset GAIN4[:INPut][:MAGNitude]?	232
[.:SENSE[1]:]CORRection:GAIN2[:INPut]:STATe	233
[.:SENSE[1]:]CORRection:GAIN2[:INPut][:MAGNitude]	234
[.:SENSE[1]:]CORRection:LOSS2[:INPut]:STATe	235
[.:SENSE[1]:]CORRection:LOSS2[:INPut][:MAGNitude]	236
[.:SENSE[1]:]CORRection:SGAMma?	237
[.:SENSE[1]:]CORRection:SGAMma:STATe	238
[.:SENSE[1]:]CORRection:SGAMma:MAGNitude	239
[.:SENSE[1]:]CORRection:SGAMma:PHASe	240
[.:SENSE[1]:]CORRection:SPARam?	241
[.:SENSE[1]:]DETEctor:FUNCTion	242
[.:SENSE[1]:]FREQUency[:CW]:FIXed	243
[.:SENSE[1]:]FREQUency[:CW]:FIXed:START	244

[:SENSe[1]:]FREQuency[:CW :FIXed]:STOP	246
[:SENSe[1]:]FREQuency[:CW :FIXed]:STEP	248
[:SENSe[1]:]LIST:FREQuency:STARt	250
[:SENSe[1]:]LIST:FREQuency:STOP	251
[:SENSe[1]:]LIST:MTYPE	252
[:SENSe[1]:]LIST:POINts	253
[:SENSe[1]:]LIST:STATe	254
[:SENSe[1]:]LIST:TSCount	255
[:SENSe[1]:]LIST:TSLot:EXCLude:OFFSet:TIME	257
[:SENSe[1]:]LIST:TSLot:EXCLude:TIME	258
[:SENSe[1]:]LIST:TSLot:TIME	259
[:SENSe[1]:]LIST:TSLot:TREF1	260
[:SENSe[1]:]LIST:TSLot:TREF2	261
[:SENSe[1]:]MRATe	262
[:SENSe[1]:]SWEep:[1]2 3 4:AUTO	264
[:SENSe[1]:]SWEep:[1]2 3 4:AUTO:REF1 REF2	265
[:SENSe[1]:]SWEep[1]2 3 4:OFFSet:TIME	266
[:SENSe[1]:]SWEep[1]2 3 4:TIME	267
[:SENSe[1]:]SWEep:APERture	268
[:SENSe[1]:]SWEep:APERture:AUTO	270
[:SENSe[1]:]TEMPerature?	271
[:SENSe[1]:]TRACe:OFFSet:TIME	274
[:SENSe[1]:]TRACe:TIME	275
[:SENSe[1]:]TRACe:UNIT	276
[:SENSe[1]:]TRACe:AUToscale	277

This chapter describes the SENSE subsystem commands.

[:SENSe[1]:]AVERage2:COUNT^[1]

Syntax

```
[:SENSe[1]:]AVERage2:COUNT <numeric_value>
```

```
[:SENSe[1]:]AVERage2:COUNT? [MIN|MAX]
```

Description

This command is used to enter the video filter length. Video filtering is applied to the traces. Successive traces are combined to reduce noise without affecting the dynamic characteristic of the signal.

The query returns the current setting of the video filter length or the value associated with MIN and MAX. The format of the response is <NR1>.

Parameter

Item	Range of values	Description/Default value
numeric_value	1 to 256 ^[a] DEF MIN MAX	A numeric value defining the filter length. - DEF: the default value is 4. - MIN: 1 - MAX: 256

[a] This is only implemented in powers of 2 (2ⁿ).

Example

```
AVER2:COUNT 16
```

Enters a video filter length of 16.

Reset condition

On reset, the filter length is set to 4.

Error message

If DET:FUNC is set to AVER, error -221, "Settings conflict" occurs.

[1] Applicable for U2042XA/U2044XA/U2049XA only.

[:SENSe[1]:]AVERage2[:STATE]^[1]

Syntax

```
[:SENSe[1]:]AVERage2[:STATE] ON|OFF|1|0
[:SENSe[1]:]AVERage2[:STATE]?
```

Description

This command is used to enable and disable video averaging.

The query enters a 1 or 0 into the output buffer indicating the status of averaging.

- 1 is returned when averaging is enabled.
- 0 is returned when averaging is disabled.

Example

```
AVER2 1           Enables video averaging.
```

Reset condition

On reset, video averaging is disabled.

Error message

If DET:FUNC is set to AVER, error -221, "Settings conflict" occurs.

[1] Applicable for U2042XA/U2044XA/U2049XA only.

[:SENSe[1]:]AVERAge:COUNT

Syntax

```
[:SENSe[1]:]AVERAge:COUNT <numeric_value>
[:SENSe[1]:]AVERAge:COUNT? [MIN|MAX]
```

Description

This command is used to enter a value for the filter length. If [:SENSe[1]:]AVERAge:COUNT:AUTO is set to ON, then entering a value for the filter length automatically sets it to OFF. Increasing the value of filter length increases measurement accuracy but also increases the time taken to make a power measurement.

Entering a value using this command automatically sets the [:SENSe[1]:]AVERAge:STATe command to ON.

The query returns the current setting of the filter length or the values associated with MIN and MAX. The format of the response is <NR1>.

NOTE

For most applications, automatic filter length selection ([:SENSe[1]:]AVERAge:COUNT:AUTO ON) is the best mode of operation. However, manual filter length selection ([:SENSe[1]:]AVERAge:COUNT <numeric_value>) is useful in applications requiring either high resolution or fast settling times, where signal variations rather than measurement noise need filtering, or when approximate results are needed quickly.

Parameter

Item	Range of values	Description/Default value
numeric_value	1 to 1024 DEF MIN MAX	A numeric value defining the filter length. - DEF: the default value is 4 - MIN: 1 - MAX: 1024

Example

```
AVER:COUNT 400           Sets the filter length to 400.
```

Reset condition

On reset, the filter length is set to 4.

Error message

If a filter length value is entered using `[:SENSE[1] :]AVERAge:COUNT` while `[:SENSE[1] :]MRATe` is set to `FAST`, the error -221, "Settings conflict" occurs. However, the filter length value is set but the `[:SENSE[1] :]AVERAge:STATe` command is not automatically set to `ON`.

[:SENSe[1]:]AVERAge:COUNT:AUtO

Syntax

```
[ :SENSe[1] : ]AVERAge:COUNT:AUtO ON|OFF|1|0
```

```
[ :SENSe[1] : ]AVERAge:COUNT:AUtO?
```

Description

This command enables and disables automatic averaging.

When the auto filter mode is enabled, the U2040 X-Series automatically sets the number of readings averaged together to satisfy the averaging requirements for most power measurements. The number of readings averaged together depends on the resolution and the power level in which the U2040 X-Series is currently operating. Refer to **Figure 1-2** for the typical number of averages for each range and resolution when the U2040 X-Series is in the auto-filter mode and set to the normal speed mode.

Setting this command to ON automatically sets the [:SENSe[1] :]AVERAge:STATE command to ON.

If [:SENSe[1] :]AVERAge:COUNT:AUtO is set to OFF, the filter length is set by [:SENSe[1] :]AVERAge:COUNT. Using [:SENSe[1] :]AVERAge:COUNT disables automatic averaging.

Auto-averaging is enabled by the MEASure:POWer:AC? and CONFIgure:POWer:AC? commands.

The query enters a 1 or 0 into the output buffer indicating whether the automatic filter length is enabled or disabled.

- 1 is returned when the automatic filter length is enabled
- 0 is returned when the automatic filter length is disabled

NOTE

For most applications, automatic filter length selection ([:SENSe[1] :]AVERAge:COUNT:AUtO ON) is the best mode of operation. However, manual filter length selection ([:SENSe[1] :]AVERAge:COUNT <numeric_value>) is useful in applications requiring either high resolution or fast settling times, where signal variations rather than measurement noise need filtering, or when approximate results are needed quickly.

Example

```
AVER:COUN:AUtO OFF      Disables automatic filter length selection.
```

Reset condition

On reset, automatic averaging is enabled.

Error message

If [:SENSE[1]:]AVERage:COUNT:AUTO is set to ON while [:SENSE[1]:]MRATe is set to FAST, error -221, "Settings conflict" occurs. However, automatic averaging is enabled but the [:SENSE[1]:]AVERage:STATe command is not automatically set to ON.

[:SENSe[1]:]AVERAge:RESet

Syntax

```
[ :SENSe[1] : ]AVERAge:RESet
```

Description

This command resets the average filter. The reset will affect the filtering in the manual and auto averaging mode.

Example

```
AVER:RES                               Resets the average filter.
```

Error message

If AVER:RES is set while LIST:STAT is set to ON, error -221, "Settings conflict" occurs.

[:SENSe[1]:]AVERAge:SDETECT

Syntax

```
[:SENSe[1]:]AVERAge:SDETECT ON|OFF|1|0
[:SENSe[1]:]AVERAge:SDETECT?
```

Description

This command enables and disables step detection. In the `AUTO` filter mode, the average of the last four values entered into the filter is compared to the average of the entire filter. If the difference between the two averages is greater than 12.5%, the digital filter is cleared. The filter then starts storing new measurement values. This feature shortens the filter time when the input power changes substantially for the filter output to get to its final value. Note that this result appears to settle faster, although true settling to the final value is unaffected.

The query enters a 1 or 0 into the output buffer indicating the status of step detection.

- 1 is returned when step detection is enabled
- 0 is returned when step detection is disabled

NOTE

Step detection is automatically disabled when `TRIG:DEL:AUTO` is `ON` and `INIT:CONT` is `OFF`.

Under these circumstances, the value of `SENS:AVER:SDET` is ignored but left unchanged (for example, `SENS:AVER:SDET` retains its current setting which may indicate that step detection is turned `ON`).

NOTE

With certain pulsed signals, step detection may prevent the final average from being completed and making the results unstable. Under these conditions, `SENS:AVER:SDET` should be set to `OFF`.

Example

```
AVER:SDET OFF           Disables step detection.
```

Reset condition

On reset, step detection is enabled.

[:SENSe[1]:]AVERAge[:STATe]

Syntax

```
[ :SENSe[1] : ]AVERAge [ :STATe ] ON|OFF|1|0  
[ :SENSe[1] : ]AVERAge [ :STATe ] ?
```

Description

This command is used to enable and disable averaging.

The query enters a 1 or 0 into the output buffer indicating the status of averaging.

- 1 is returned when averaging is enabled
- 0 is returned when averaging is disabled

Example

```
AVER 1      Enables averaging.
```

Reset condition

On reset, averaging is enabled.

Error messages

- If [:SENSe[1] :]AVERAge:STATe is set to ON while [:SENSe[1] :]MRATe is set to FAST, the error -221, "Settings conflict" occurs.
- If [:SENSe[1] :]AVERAge:STATe is set to ON while LIST:STAT is set to ON, error -221, "Settings conflict;list mode is running" occurs.

[:SENSe[1]:]BANDwidth|BWIDth:VIDeo^[1]

Syntax

```
[:SENSe[1]:]BANDwidth|BWIDth:VIDeo HIGH|MEDIum|LOW|OFF
[:SENSe[1]:]BANDwidth|BWIDth:VIDeo?
```

Description

This command sets the bandwidth of the U2040 X-Series.

Values for HIGH, MEDIum, LOW, and OFF are as shown below:

LOW	MEDIum	HIGH	OFF
300 kHz	1.5 MHz	5 MHz	5 MHz

The query returns the current bandwidth setting.

NOTE

Selection of LOW, MED, or HIGH video bandwidth turns on the digital FIR filter with passband flatness of ± 0.1 dB. In the OFF state, no corrections are applied and the response has a slow roll-off.

Example

```
BAND:VID HIGH           Sets the bandwidth to high.
```

Reset condition

On reset, the bandwidth is set to OFF.

Error message

If DET:FUNC is set to AVER, error -221, "Settings conflict" occurs.

[1] Applicable for U2042XA/U2044XA/U2049XA only.

[[:SENSe[1]:]BANDwidth|BWIDth:VIDeo:STATe^[1]

Syntax

```
[[:SENSe[1]:]BANDwidth|BWIDth:VIDeo:STATe ON|OFF|1|0  
[:SENSe[1]:]BANDwidth|BWIDth:VIDeo:STATe?
```

Description

This command is used to enable and disable video bandwidth.

The query enters a 1 or 0 into the output buffer indicating the status of the video bandwidth.

- 1 is returned when video bandwidth is enabled
- 0 is returned when video bandwidth is disabled

Example

```
BAND:VID:STAT ON           Turns on video bandwidth.
```

Reset condition

On reset, video bandwidth is disabled.

Error message

If DET:FUNC is set to AVER, error -221, "Settings conflict" occurs.

[1] Applicable for U2042XA/U2044XA/U2049XA only.

[:SENSE[1]:]BUFFEr:COUNT

Syntax

```
[:SENSE[1]:]BUFFEr:COUNT <numeric_value>
[:SENSE[1]:]BUFFEr:COUNT?
```

Description

This command sets the buffer size for triggered measurements and must be used in conjunction with an external trigger. This command can only be set when `FREQ:STEP` is set to 0, otherwise the buffer size will automatically be overwritten by the frequency sweep step value.

The query returns the current buffer size. The format of the response is `<NR1>`.

Parameter

Item	Range of values	Description/Default value
numeric_value	1 to 4096	A numeric value defining the buffer size. Units are resolved to 1.

Example

```
BUFF:COUN 10           Sets the buffer size to 10.
```

Reset condition

On reset, the buffer size is set to 1.

Error messages

- If the limits of the values are exceeded, error –222, “Data out of range;value clipped to upper (or lower) limit” occurs.
- If `BUFF:COUN` is set when `TRIG:SOUR` is not set to `EXT`, error –221, “Settings conflict. Invalid acquisition mode” occurs.
- If `BUFF:COUN` is set when `FREQ:STEP` is not set to 0, error –221, “Settings conflict. Frequency sweep enabled. Buffer count overridden” occurs.

[:SENSe[1]:]BUFFer:MTYPe

Syntax

```
[ :SENSe[1] : ]BUFFer:MTYPe "AVER" | "PEAK" | "PTAV" | "MIN"  
[ :SENSe[1] : ]BUFFer:MTYPe?
```

Description

This command sets the measurement type of the buffered mode.

The query returns the current measurement type for the buffered mode.

Example

```
BUFF:MTYP "AVER"      Sets the measurement type to AVER for the buffered mode.
```

Reset condition

On reset, the measurement type for the buffered mode is AVER.

Error messages

- If BUFF:MTYP is set when TRIG:SOUR is not set to EXT or DET:FUNC is set to AVER, error -221, "Settings conflict. Invalid acquisition mode" occurs.
- If the parameter set is an invalid string, error -224, "Illegal parameter value" occurs.

[:SENSE[1]:]CORREction:CSET2:STATe

Syntax

```
[:SENSE[1]:]CORREction:CSET2:STATe ON|OFF|1|0
[:SENSE[1]:]CORREction:CSET2:STATe?
```

Description

This command is to enable and disable the use of the currently active frequency-dependent offset table. When a table has been selected and enabled, the offsets stored in it can be used by specifying the required frequency using the [:SENSE[1]:]FREQuency command.

The query returns a 1 or 0 into the output buffer indicating whether a table is enabled or disabled.

- 1 is returned when the table is enabled
- 0 is returned when the table is disabled

Example

```
CORR:CSET2:STAT 1
```

Enables the use of the currently active frequency-dependent offset table.

Reset condition

On reset, the state is not affected.

Error message

If you attempt to set this command to ON and no table has been selected using [:SENSE[1]:]CORREction:CSET2[:SElect], then error -221, "Settings conflict" occurs and [:SENSE[1]:]CORREction:CSET2:STATe remains OFF.

[:SENSe[1]:]CORRection:CSET3:STATe

Syntax

```
[ :SENSe[1]: ]CORRection:CSET3:STATe ON|OFF|1|0  
[ :SENSe[1]: ]CORRection:CSET3:STATe?
```

Description

This command is used to enable or disable the table-based gamma correction.

If this is enabled, gamma values from the currently selected gamma table will be used for correction.

The query returns a 1 or 0 into the output buffer indicating whether the table-based gamma correction is enabled or disabled.

- 1 is returned when the table-based gamma correction is enabled
- 0 is returned when the table-based gamma correction is disabled

NOTE

This is mutually exclusive with the [:SENSe[1]:]CORRection:SGAMma:STATe command.

Example

```
CORR:CSET3:STAT ON      Enables the table-based gamma correction.
```

Reset condition

On reset, the state is not affected.

Error messages

- If you attempt to set this command to ON and no table has been selected using [:SENSe[1]:]CORRection:CSET3[:SELection], then error -221, "Settings conflict" occurs and [:SENSe[1]:]CORRection:CSET3:STATe remains OFF.
- If you set this command to ON and [:SENSe[1]:]CORRection:SGAMma:STATe is currently ON, [:SENSe[1]:]CORRection:SGAMma:STATe will be set to OFF and error -221, "Settings conflict; Single point gamma is being switched off" occurs.

[:SENSE[1]:]CORRection:CSET4:STATe

Syntax

```
[:SENSE[1]:]CORRection:CSET4:STATe ON|OFF|1|0
[:SENSE[1]:]CORRection:CSET4:STATe?
```

Description

This command is used to enable or disable the S-parameter correction.

When this is enabled, S-parameter values from the selected S-parameter table will be used for correction.

The query returns a 1 or 0 into the output buffer indicating whether the S-parameter correction is enabled or disabled.

- 1 is returned when the S-parameter correction is enabled
- 0 is returned when the S-parameter correction is disabled

Example

```
CORR:CSET4:STAT ON      Enables the S-parameter correction.
```

Reset condition

On reset, the state is not affected.

Error message

If you attempt to set this command to ON and no table has been selected using [:SENSE[1]:]CORRection:CSET4[:SELEct], then error -221, "Settings conflict" occurs and [:SENSE[1]:]CORRection:CSET4:STATe remains OFF.

[:SENSe[1]:]CORRection:CSET2[:SElect]

Syntax

```
[:SENSe[1]:]CORRection:CSET2[:SElect] <string>
[:SENSe[1]:]CORRection:CSET2[:SElect]?
```

Description

This command enters the name of the frequency-dependent offset table to be used.

The query returns the name of the selected table as a quoted string. If no table is selected, an empty string is returned.

NOTE

If [:SENSe[1]:]CORRection:CSET2:STATe is set to OFF, the selected frequency-dependent offset table is not being used.

Parameter

Item	Range of values	Description/Default value
string	Any existing table name (Existing table names can be listed using MEMory:CATalog:TABLE?.) "DEFAULT"	String data representing a frequency-dependent offset table name. "DEFAULT": this is the default table name.

Example

```
CORR:CSET2 "PW1"
```

Enters the name of the frequency-dependent offset table to be used.

Reset condition

On reset, the selected table is not affected.

Error messages

- If `<string>` is not valid, error -224, "Illegal parameter value" occurs.
- If a table called `<string>` does not exist, error -256, "File name not found" occurs.
- When a frequency-dependent offset table is selected, the U2040 X-Series verifies that the number of offset points defined is equal to the number of frequency points defined. If this is not the case, error -226, "Lists not the same length" occurs.

[:SENSe[1]:]CORRection:CSET3[:SElect]

Syntax

```
[:SENSe[1]:]CORRection:CSET3[:SElect] <string>
[:SENSe[1]:]CORRection:CSET3[:SElect]?
```

Description

This command is used to select the gamma table to be used in the table-based gamma correction.

The query returns the currently selected gamma table used in the table-based gamma correction. If no table is selected, the query returns an empty string.

Parameter

Item	Range of values	Description/Default value
string	Any existing table name (Existing table names can be listed using MEMory:CATalog:TABLE?.) "DEFAULT"	String data representing a gamma table name. "DEFAULT": this is the default table name.

Example

```
CORR:CSET3 "G2"           Enters the name of the gamma table to be used.
```

Reset condition

On reset, the selected table is not affected.

Error messages

- If <string> is not valid, error -224, "Illegal parameter value" occurs.
- If a table called <string> does not exist, error -256, "File name not found" occurs.
- When a gamma table is selected, the U2040 X-Series verifies that the number of magnitude-phase offset pairs defined is equal to the number of frequency points defined. If they do not match, error -226, "Lists not the same length" occurs.

[:SENSe[1]:]CORRection:CSET4[:SElect]

Syntax

```
[:SENSe[1]:]CORRection:CSET4[:SElect] <string>
[:SENSe[1]:]CORRection:CSET4[:SElect]?
```

Description

This command is used to select the S-parameter table to be used for S-parameter correction.

The query returns the currently selected S-parameter table used for S-parameter correction. If no table is selected, the query returns an empty string.

Parameter

Item	Range of values	Description/Default value
string	Any existing table name (Existing table names can be listed using MEMory:CATalog:TABLE?.) "DEFAULT"	String data representing an S-parameter table name. "DEFAULT": this is the default table name.

Example

```
CORR:CSET4 "S6"           Enters the name of the S-parameter table to be used.
```

Reset condition

On reset, the selected table is not affected.

Error messages

- If <string> is not valid, error -224, "Illegal parameter value" occurs.
- If a table called <string> does not exist, error -256, "File name not found" occurs.
- When an S-parameter table is selected, the U2040 X-Series verifies that the number of magnitude-phase pairs defined for S11, S12, S21, and S22 is equal to the number of frequency points defined. If they do not match, error -226, "Lists not the same length" occurs.

[:SENSe[1]:]CORRection:DCYClE|GAIN3:STATe

Syntax

```
[ :SENSe[1]: ]CORRection:DCYClE|GAIN3:STATe ON|OFF|1|0  
[ :SENSe[1]: ]CORRection:DCYClE|GAIN3:STATe?
```

Description

This command is used to enable and disable the pulse power measurement.

The query returns a 1 or 0 into the output buffer indicating the status of the pulse power measurement.

- 1 is returned when the pulse power measurement is enabled
- 0 is returned when the pulse power measurement is disabled

Example

```
CORR:DCYC:STAT 1           Enables the pulse power measurement.
```

Reset condition

On reset, the pulse power measurement is disabled.

Error message

If this command is used when `SENSe:DET:FUNC` is set to `NORMa1`, error -221, “Settings conflict” occurs.

[:SENSE[1]:]CORREction:DCYCLE|GAIN3[:INPut][:MAGNitude]

Syntax

```
[:SENSE[1]:]CORREction:DCYCLE|GAIN3[:INPut][:MAGNitude]
<numeric_value>

[:SENSE[1]:]CORREction:DCYCLE|GAIN3[:INPut][:MAGNitude]?
[MIN|MAX]
```

Description

This command is used to set the duty cycle for the pulse power measurement. Pulse power measurements average out any aberrations in the pulse such as overshoot or ringing. The result returned for a pulse power measurement is a mathematical representation of the pulse power rather than an actual measurement.

The U2040 X-Series measures the average power in the pulsed input signal and then divides the result by the duty cycle value to obtain a pulse power reading.

Entering a value using this command automatically turns the [:SENSE[1]:]CORREction:DCYCLE|GAIN3:STATE command to ON.

The query returns the current setting of the duty cycle or the values associated with MIN and MAX.

Parameter

Item	Range of values	Description/Default value
numeric_value	0.001 to 99.999% DEF MIN MAX	A numeric value for the duty cycle: - DEF: the default value is 1% - MIN: 0.001% - MAX: 99.999%

Example

```
CORR:DCYC 90           Sets a duty cycle of 90%.
```

Reset condition

On reset, the duty cycle is set to 1% (DEF).

Error messages

- If a duty cycle value is entered while `SENSe:MRATe` is set to `FAST`, error -221, "Settings conflict" occurs. However, the duty cycle value is set but the `SENSe:CORRection:DCYClE|GAIN3:STATe` command is not automatically set to `ON`.
- If this command is used when `SENSe:DET:FUNC` is set to `NORMa1`, error -221, "Settings conflict" occurs.

`[:SENSe[1]:]CORRection:FDOFfset|GAIN4[:INPut][:MAGNitude]?`

Syntax

`[[:SENSe[1]:]CORRection:FDOFfset|GAIN4[:INPut][:MAGNitude]?`

Description

This query is used to return the frequency-dependent offset currently being applied.

Example

`CORR:GAIN4?` Queries the current frequency-dependent offset being applied.

Reset condition

On reset, the frequency-dependent offset is not affected.

[:SENSe[1]:]CORRection:GAIN2[:INPut]:STATe

Syntax

```
[ :SENSe[1]: ]CORRection:GAIN2[:INPut]:STATe ON|OFF|1|0  
[ :SENSe[1]: ]CORRection:GAIN2[:INPut]:STATe?
```

Description

This command is used to enable/disable a channel offset for the U2040 X-Series setup. The [:SENSe[1]:]CORRection:GAIN2[:INPut][:MAGNitude] command is used to enter the loss/gain value.

The query enters 1 or 0 into the output buffer indicating the status of the channel offset.

- 1 is returned if a channel offset is enabled
- 0 is returned if a channel offset is disabled

Example

```
CORR:GAIN2:STAT ON      Enables the channel offset.
```

Reset condition

On reset, channel offsets are disabled.

Error message

If [:SENSe[1]:]CORRection:GAIN2[:INPut]:STATe is set to ON while [:SENSe[1]:]MRATe is set to FAST, error -221, "Settings conflict" occurs.

[:SENSE[1]:]CORREction:GAIN2[:INPut][:MAGNitude]

Syntax

```
[:SENSE[1]:]CORREction:GAIN2[:INPut][:MAGNitude] <numeric_value>
[:SENSE[1]:]CORREction:GAIN2[:INPut][:MAGNitude]? [MIN|MAX]
```

Description

This command is used to enter a channel offset value for the U2040 X-Series setup, for example cable loss. The U2040 X-Series then corrects every measurement by this factor to compensate for the loss/gain.

Entering a value for GAIN2 using this command automatically turns the [:SENSE[1]:]CORREction:GAIN2:STATe command to ON.

The query returns the current setting of the channel offset or the values associated with MIN and MAX.

Parameter

Item	Range of values	Description/Default value
numeric_value	-100 to +100 dB DEF MIN MAX	A numeric value: - DEF: the default is 0.00 dB - MIN: -100 dB - MAX: +100 dB

Example

```
CORR:GAIN2 50      Sets a channel offset of 50 dB.
```

Reset condition

On reset, GAIN2 is set to 0.00 dB.

Error message

If a loss/gain correction value is entered using [:SENSE[1]:]CORREction:GAIN2[:INPut][:MAGNitude] while [:SENSE[1]:]MRATe is set to FAST, error -221, "Settings conflict" occurs. However, the correction value is set but the [:SENSE[1]:]CORREction:GAIN2[:INPut]:STATe command is not automatically set to ON.

[:SENSe[1]:]CORRection:LOSS2[:INPut]:STATe

Syntax

```
[ :SENSe[1]: ]CORRection:LOSS2[:INPut]:STATe ON|OFF|1|0  
[ :SENSe[1]: ]CORRection:LOSS2[:INPut]:STATe?
```

Description

This command is used to enable/disable a channel offset for the U2040 X-Series setup. The [:SENSe[1]:]CORRection:LOSS2[:INPut]:[:MAGNitude] command is used to enter the gain/loss value.

The query enters 1 or 0 into the output buffer indicating the status of the channel offset.

- 1 is returned if a channel offset is enabled
- 0 is returned if a channel offset is disabled

Example

```
CORR:LOSS2:STAT ON      Enables the channel offset.
```

Reset condition

On reset, channel offsets are disabled.

Error message

If [:SENSe[1]:]CORRection:LOSS2[:INPut]:STATe is set to ON while [:SENSe[1]:]MRATe is set to FAST, error -221, "Settings conflict" occurs.

[:SENSE[1]:]CORREction:LOSS2[:INPut][:MAGNitude]

Syntax

```
[:SENSE[1]:]CORREction:LOSS2[:INPut][:MAGNitude] <numeric_value>
[:SENSE[1]:]CORREction:LOSS2[:INPut][:MAGNitude]? [MIN|MAX]
```

Description

This command is used to enter a channel offset value for the U2040 X-Series setup, for example system gain or a cable loss. The U2040 X-Series then corrects every measurement by this factor to compensate for the gain/loss.

Entering a value for LOSS2 using this command automatically turns the [:SENSE[1]:]CORREction:LOSS2[:INPut]:STATe command to ON.

The query returns the current setting of the channel offset or the values associated with MIN and MAX.

Parameter

Item	Range of values	Description/Default value
numeric_value	-100 to +100 dB DEF MIN MAX	A numeric value: - DEF: the default is 0.00 dB - MIN: -100 dB - MAX: +100 dB

Example

```
CORR:LOSS2 -50    Sets a channel offset of -50 dB.
```

Reset condition

On reset, LOSS2 is set to 0.00 dB.

Error message

If a gain/loss correction value is entered using [:SENSE[1]:]CORREction:LOSS2[:INPut][:MAGNitude] while [:SENSE[1]:]MRATe is set to FAST, error -221, "Settings conflict" occurs. However, the correction value is set but the [:SENSE[1]:]CORREction:LOSS2[:INPut]:STATe command is not automatically set to ON.

[:SENSe[1]:]CORRection:SGAMma?

Syntax

```
[ :SENSe[1] : ]CORRection:SGAMma?
```

Description

This query returns the source gamma magnitude-phase pair which is currently being used in gamma correction.

Example

```
CORR:SGAM?
```

This query returns the source gamma magnitude-phase pair which is currently being used in gamma correction.

[:SENSE[1]:]CORREction:SGAMma:STATe

Syntax

```
[:SENSE[1]:]CORREction:SGAMma:STATe ON|OFF|1|0
[:SENSE[1]:]CORREction:SGAMma:STATe?
```

Description

This command is used to enable or disable single point gamma correction.

Values from [:SENSE[1]:]CORREction:SGAMma:MAGNitude and [:SENSE[1]:]CORREction:SGAMma:PHASe apply across all frequency values and are used for correction when this is enabled.

The query returns the single point gamma correction state.

Example

```
CORR:SGAM:STAT ON      Enables single point gamma correction.
```

Reset condition

On reset, the state is not affected.

Error message

If you set this command to ON and [:SENSE[1]:]CORREction:CSET3:STATe is currently ON, it will set [:SENSE[1]:]CORREction:CSET3:STATe to OFF and error -221, "Settings conflict; Table based gamma is being switched off" will occur.

This behavior indicates that both [:SENSE[1]:]CORREction:SGAMma:STATe and [:SENSE[1]:]CORREction:CSET3:STATe are mutually exclusive.

[:SENSe[1]:]CORRection:SGAMma:MAGNitude

Syntax

```
[:SENSe[1]:]CORRection:SGAMma:MAGNitude <numeric_value>
[:SENSe[1]:]CORRection:SGAMma:MAGNitude?
```

Description

This command is used to set the magnitude of the source reflection coefficient, Γ_G .

The query returns the magnitude of the source reflection coefficient.

Parameter

Item	Range of values	Description/Default value
numeric_value	0.0 to 0.999	A numeric value. The default value is 0.0.

Example

```
CORR:SGAM:MAGN 0.5
```

This command sets the magnitude of the source reflection coefficient at 0.5.

Reset condition

On reset, the value is not affected.

Error message

If the input values are outside the acceptable range of values, error -222 “Data out of range” occurs.

[:SENSe[1]:]CORRection:SGAMma:PHASe

Syntax

```
[:SENSe[1]:]CORRection:SGAMma:PHASe <numeric_value>
[:SENSe[1]:]CORRection:SGAMma:PHASe?
```

Description

This command is used to set the phase of the source reflection coefficient, Γ_G .

The query returns the phase of the source reflection coefficient.

Parameter

Item	Range of values	Description/Default value
numeric_value	$-180.0^\circ \leq p < +180.0^\circ$	A numeric value. The default value is 0.

Example

```
CORR:SGAM:PHAS 45
```

This command sets the phase of the source reflection coefficient at 45.

Reset condition

On reset, the value is not affected.

Error message

If the input values are outside the acceptable range of values, error -222 “Data out of range” occurs.

[:SENSe[1]:]CORRection:SPARam?

Syntax

```
[:SENSe[1]:]CORRection:SPARam? S11|S12|S21|S22
```

Description

This query returns the current magnitude-phase pair values for the specified S-parameter type.

Parameter

Item	Range of values	Description/Default value
S11 S12 S21 S22	For S11, S22 - Magnitude: (0.0 to 0.999) - Phase: ($-180.0^\circ \leq p < +180.0^\circ$) For S12, S21 - Magnitude: (1.0×10^{-5} to 1.0×10^5) - Phase: ($-180.0^\circ \leq p < +180.0^\circ$)	Returns the magnitude-phase pair values.

Example

```
CORR:SPAR? S11
```

Returns the current magnitude-phase pair values for the S11 S-parameter.

[:SENSe[1]:]DETEctor:FUNCTion

Syntax

```
[:SENSe[1]:]DETEctor:FUNCTion <character_data>
[:SENSe[1]:]DETEctor:FUNCTion?
```

Description

This command sets the measurement mode to normal or average.

The query returns the current measurement mode setting.

Parameter

Item	Range of values	Description/Default value
character_data	NORMAL ^[a] AVERage	Defines the measurement mode: <ul style="list-style-type: none"> - NORMAL: sets to the normal mode. Normal mode allows time-selective measurements on a wide variety of signal types. - AVERage: sets to the average mode. Average mode also allows time-selective measurements but at a slightly larger dynamic range. This is the default measurement mode.

[a] Applicable for U2042XA/U2044XA/U2049XA only.

Example

```
DET:FUNC NORM           Sets the normal measurement mode.
```

Reset condition

On reset, the mode is set to AVERage.

[:SENSe[1]:]FREQUency[:CW|:FIXed]

Syntax

```
[:SENSe[1]:]FREQUency[:CW|:FIXed] <numeric_value>
[:SENSe[1]:]FREQUency[:CW|:FIXed]? [MIN|MAX]
```

Description

This command is used to enter a frequency.

The query returns the current frequency setting or the values associated with `MIN` and `MAX`. The unit in which the results are returned is Hz.

Parameter

Item	Range of values	Description/Default value
numeric_value	1 kHz to 1000.0 GHz ^[a] DEF MIN MAX	A numeric value for the frequency: - DEF: the default value is 50 MHz - MIN: 1 kHz - MAX: 1000.0 GHz The default unit is Hz.

[a] The following measurement units can be used:

- Hz
- kHz (10^3)
- MHz (10^6)
- GHz (10^9)

Example

```
FREQ 500kHz      Enters a frequency of 500 kHz.
```

Reset condition

On reset, the frequency is set to 50 MHz (DEF).

[:SENSe[1]:]FREQuency[:CW|:FIXed]:STARt

Syntax

```
[:SENSe[1]:]FREQuency[:CW|:FIXed]:STARt <numeric_value>
[:SENSe[1]:]FREQuency[:CW|:FIXed]:STARt? [MIN|MAX]
```

Description

This command sets the start frequency for frequency sweep measurements and must be used in conjunction with an external trigger. If `FREQ:STEP` is set to 0, the `FREQ:STAR` command will be set but will not take effect. The `FREQ:STAR`, `FREQ:STOP`, and `FREQ:STEP` commands can be set in any desirable sequence.

The query returns the current start frequency setting or the values associated with `MIN` and `MAX`. The unit in which the results are returned is Hz.

NOTE

When the frequency sweep mode is configured with the frequency step size within its range (1 to 4096), the following conditions apply:

- If the frequency stop point is greater than the frequency start point, the frequency range will be swept in an ascending order.
- If the frequency stop point is less than the frequency start point, the frequency range will be swept in a descending order.
- If the frequency stop point and the frequency start point are equal, it is the same as the power sweep mode.

Parameter

Item	Range of values	Description/Default value
numeric_value	1 kHz to 1000 GHz DEF MIN MAX	A numeric value for the start frequency: - DEF: the default value is 50 MHz - MIN: 1 kHz - MAX: 1000 GHz The default unit is Hz.

Example

```
FREQ:STAR 500kHz
```

Enters a start frequency of 500 kHz.

Reset condition

On reset, the start frequency is set to 50 MHz (DEF).

Error message

If limits of the values are exceeded, error -222, "Data out of range;value clipped to upper (or lower) limit" occurs.

[:SENSe[1]:]FREQuency[:CW|:FIXed]:STOP

Syntax

```
[:SENSe[1]:]FREQuency[:CW|:FIXed]:STOP <numeric_value>
[:SENSe[1]:]FREQuency[:CW|:FIXed]:STOP? [MIN|MAX]
```

Description

This command sets the stop frequency for frequency sweep measurements and must be used in conjunction with an external trigger. If `FREQ:STEP` is set to 0, the `FREQ:STOP` command will be set but will not take effect. The `FREQ:STAR`, `FREQ:STOP`, and `FREQ:STEP` commands can be set in any desirable sequence.

The query returns the current stop frequency setting or the values associated with `MIN` and `MAX`. The unit in which the results are returned is Hz.

NOTE

When the frequency sweep mode is configured with the frequency step size within its range (1 to 4096), the following conditions apply:

- If the frequency stop point is greater than the frequency start point, the frequency range will be swept in an ascending order.
- If the frequency stop point is less than the frequency start point, the frequency range will be swept in a descending order.
- If the frequency stop point and the frequency start point are equal, it is the same as the power sweep mode.

Parameter

Item	Range of values	Description/Default value
numeric_value	1 kHz to 1000 GHz DEF MIN MAX	A numeric value for the stop frequency: - DEF: the default value is 50 MHz - MIN: 1 kHz - MAX: 1000 GHz Units are resolved to 1 kHz.

Example

```
FREQ:STOP 500kHz
```

Enters a stop frequency of 500 kHz.

Reset condition

On reset, the stop frequency is set to 50 MHz (DEF).

Error message

If limits of the values are exceeded, error -222, "Data out of range;value clipped to upper (or lower) limit" occurs.

[:SENSe[1]:]FREQuency[:CW|:FIXed]:STEP

Syntax

```
[:SENSe[1]:]FREQuency[:CW|:FIXed]:STEP <numeric_value>
[:SENSe[1]:]FREQuency[:CW|:FIXed]:STEP? [MIN|MAX]
```

Description

This command sets the number of steps for frequency sweep measurements and must be used in conjunction with an external trigger. The frequency sweep range will be equally divided by the frequency steps.

The number of frequency steps can be calculated using the following equation:

$$\text{Step} = \frac{(\text{Stop frequency} - \text{Start frequency} + \text{Interval})}{\text{Interval}}$$

where,

Step = Number of frequency steps

Start frequency = Frequency sweep start point

Stop frequency = Frequency sweep stop point

Interval = Frequency step size

Example:

If the start frequency is 1 GHz, the stop frequency is 5 GHz, and the interval is 0.5 GHz, the number of frequency steps is calculated as follows:

$$\text{Step} = \frac{(5 \text{ GHz} - 1 \text{ GHz} + 0.5 \text{ GHz})}{0.5 \text{ GHz}} = 9$$

The `FREQ:STAR`, `FREQ:STOP`, and `FREQ:STEP` commands can be set in any desirable sequence. The calculated frequency step size will be rounded to the nearest kHz with the minimum size of 1 kHz. When the frequency range is less than the frequency sweep step size, the remaining steps will be repeated with the last frequency point.

The query returns the current number of frequency steps. The format of the response is `<NR1>`.

Parameter

Item	Range of values	Description/Default value
numeric_value	0 to 4096 DEF MIN MAX	A numeric value defining the number of steps for frequency sweep measurements. - DEF: the default value is 0 - MIN: 0 - MAX: 4096 Units are resolved to 1.

Example

`FREQ:STEP 10` Sets the number of frequency steps to 10.

Reset condition

On reset, the frequency step size is set to 0.

Error messages

- If the limits of the values are exceeded, error -222, "Data out of range;value clipped to upper (or lower) limit" occurs.
- If the acquisition mode is in free run, error -221, "Setting conflict. Invalid acquisition mode" occurs.

[:SENSe[1]:]LIST:FREQuency:STARt

Syntax

```
[:SENSe[1]:]LIST:FREQuency:STARt <numeric_value>
[:SENSe[1]:]LIST:FREQuency:STARt? [MIN|MAX]
```

Description

This command sets the start frequency for frequency sweep measurements. Configuring the [:SENSe[1]:]LIST:FREQuency:STOP value to be the same as STARt means the frequency will not be changed during the test.

The query returns the current start frequency setting or the values associated with MIN and MAX. The unit in which the results are returned is Hz.

Parameter

Item	Range of values	Description/Default value
numeric_value	1 kHz to 1000 GHz DEF MIN MAX	A numeric value for the start frequency: - DEF: the default value is 50 MHz - MIN: 1 kHz - MAX: 1000 GHz Units are resolved to 1 kHz.

Example

```
LIST:FREQ:STAR 500kHz      Enters a start frequency of 500 kHz.
```

Reset condition

On reset, the start frequency is set to 50 MHz (DEF).

Error messages

- If the limits of the values are exceeded, error -222, "Data out of range;value clipped to upper (or lower) limit" occurs.
- If LIST:FREQ:STAR is set while a sequence is running, error -221, "Settings conflict;list mode is running" occurs.

[:SENSe[1]:]LIST:FREQuency:STOP

Syntax

```
[ :SENSe[1]: ]LIST:FREQuency:STOP <numeric_value>
[ :SENSe[1]: ]LIST:FREQuency:STOP? [MIN|MAX]
```

Description

This command sets the stop frequency for frequency sweep measurements. Configuring the [:SENSe[1]:]LIST:FREQuency:START value to be the same as STOP means the frequency will not be changed during the test.

The query returns the current stop frequency setting or the values associated with MIN and MAX. The unit in which the results are returned is Hz.

Parameter

Item	Range of values	Description/Default value
numeric_value	1 kHz to 1000 GHz DEF MIN MAX	A numeric value for the stop frequency: - DEF: the default value is 50 MHz - MIN: 1 kHz - MAX: 1000 GHz Units are resolved to 1 kHz.

Example

```
LIST:FREQ:STOP 500kHz      Enters a stop frequency of 500 kHz.
```

Reset condition

On reset, the stop frequency is set to 50 MHz (DEF).

Error messages

- If the limits of the values are exceeded, error -222, "Data out of range;value clipped to upper (or lower) limit" occurs.
- If LIST:FREQ:STOP is set while a sequence is running, error -221, "Settings conflict;list mode is running" occurs.

[:SENSe[1]:]LIST:MTYPE

Syntax

```
[:SENSe[1]:]LIST:MTYPE <string>
[:SENSe[1]:]LIST:MTYPE?
```

Description

This command sets the measurement type to be performed.

The query returns the current measurement type.

Parameter

Item	Range of values	Description/Default value
string	"AVER"	Defines the measurement type.
	"PEAK" ^[a]	
	"PTAV" ^[a]	The default measurement type is "AVER".
	"MIN" ^[a]	

[a] Applicable for U2042XA/U2044XA/U2049XA only.

Example

```
LIST:MTYP "AVER"           Sets the measurement type to AVER.
```

Reset condition

On reset, the measurement type is AVER.

Error messages

- If LIST:MTYP is set to "PEAK", "PTAV", or "MIN" when DET:FUNC is set to AVER, error –221, "Settings conflict" occurs.
- If LIST:MTYP is set while a sequence is running, error –221, "Settings conflict;list mode is running" occurs.

[[:SENSe[1]:]LIST:POINTs

Syntax

```
[[:SENSe[1]:]LIST:POINTs <numeric_value>
[:SENSe[1]:]LIST:POINTs?
```

Description

This command sets the number of measurements to be made. If the values set at `[[:SENSe[1]:]LIST:FREQuency:START` and `[[:SENSe[1]:]LIST:FREQuency:STOP` are different, this setting will also affect the frequency step during the frequency sweep. The number of measurement points can be calculated using the following equation:

$$\text{Points} = \left(\frac{\text{Stop frequency} - \text{Start frequency}}{\text{Frequency step}} \right) + 1$$

The query returns the current setting of the measurement points. The format of the response is `<NR1>`.

Parameter

Item	Range of values	Description/Default value
numeric_value	1 to 4096	A numeric value defining the measurement points. The default value is 1. Units are resolved to 1.

Example

```
LIST:POIN 10           Sets the measurement points to 10.
```

Reset condition

On reset, the number of measurement points is set to 1.

Error messages

- If the limits of the values are exceeded, error -222, "Data out of range;value clipped to upper (or lower) limit" occurs.
- If `LIST:POIN` is set while a sequence is running, error -221, "Settings conflict;list mode is running" occurs.

[:SENSe[1]:]LIST:STATe

Syntax

```
[:SENSe[1]:]LIST:STATe ON|OFF|1|0
[:SENSe[1]:]LIST:STATe?
```

Description

This command is used to enable/disable the list mode for frequency sweep measurements.

The query enters 1 or 0 into the output buffer indicating the status of the list mode.

- 1 is returned if the list mode is enabled
- 0 is returned if the list mode is disabled

Example

```
LIST:STAT ON           Enables the list mode.
```

Reset condition

On reset, the list mode is disabled.

Error messages

- If LIST:STAT is set when TRIG:SOUR is not set to EXT, error -221, "Settings conflict;list mode requires EXT trigger source" occurs.
- If LIST:STAT is set while a sequence is running, error -221, "Settings conflict;list mode is running" occurs.

NOTE

- If LIST:STAT is set to ON when DET:FUNC is set to NORM,
- SENS:SWE[1]|2|3|4:AUTO will be set to OFF.
 - SENS:TRAC:STAT will be set to OFF.
-

[:SENSe[1]:]LIST:TSCount^[1]

Syntax

```
[:SENSe[1]:]LIST:TSCount <numeric_value>
[:SENSe[1]:]LIST:TSCount?
```

Description

This command sets the number of slots that will be measured within a burst. Setting the slot to 1 is equivalent to a basic power sweep mode.

The query returns the current setting of the number of slots that will be measured within a burst. The format of the response is <NR1>.

NOTE

FETC?, READ?, and MEAS? will return the LIST:TSC number of readings multiplied by the LIST:POIN settings.

Parameter

Item	Range of values	Description/Default value
numeric_value	1 to 16	A numeric value defining the number of slots that will be measured within a burst. The default value is 1. Units are resolved to 1.

Example

```
LIST:TSC 4
```

Sets the number of slots to 4.

Reset condition

On reset, the number of slots is set to 1.

[1] Applicable for U2042XA/U2044XA/U2049XA only.

Error messages

- If `DET:FUNC` is set to `AVER`, error -221, "Settings conflict" occurs.
- If the limits of the values are exceeded, error -222, "Data out of range;value clipped to upper (or lower) limit" occurs.
- If the product of the `LIST:TSL:TIME` value multiplied by the `LIST:TSC` value exceeds 1 s, error -221, "Settings conflict;Capture buffer size too large. Please reduce time slot duration or count." occurs.
- If `LIST:TSC` is set while a sequence is running, error -221, "Settings conflict;list mode is running" occurs.

[:SENSe[1]:]LIST:TSLot:EXCLude:OFFSet:TIME^[1]

Syntax

```
[:SENSe[1]:]LIST:TSLot:EXCLude:OFFSet:TIME <numeric_value>
```

```
[:SENSe[1]:]LIST:TSLot:EXCLude:OFFSet:TIME?
```

Description

This command is used to set the exclusion area offset time relative to the beginning of the time slot.

The query returns the current exclusion area offset time.

Parameter

Item	Range of values	Description/Default value
numeric_value	0.0 s to 0.1 s	A numeric value defining the exclusion area offset time. The default value is 0 s. Units are resolved to 50 ns.

Example

```
LIST:TSL:EXCL:OFFS:TIME 0.01      Sets the exclusion area offset time to 0.01 s.
```

Reset condition

On reset, the value is 0 s.

Error messages

- If DET:FUNC is set to AVER, error -221, "Settings conflict" occurs.
- If the limits of the values are exceeded, error -222, "Data out of range;value clipped to upper (or lower) limit" occurs.
- If LIST:TSL:EXCL:OFFS:TIME is set while a sequence is running, error -221, "Settings conflict;list mode is running" occurs.

[1] Applicable for U2042XA/U2044XA/U2049XA only.

[:SENSE[1]:]LIST:TSLot:EXCLude:TIME^[1]

Syntax

```
[:SENSE[1]:]LIST:TSLot:EXCLude:TIME <numeric_value>
[:SENSE[1]:]LIST:TSLot:EXCLude:TIME?
```

Description

This command is used to set the exclusion duration interval within the time slot. The exclusion duration interval is useful for excluding the mid-amble interval in the GSM slot. The query returns the current exclusion duration interval within the time slot.

Parameter

Item	Range of values	Description/Default value
numeric_value	0.0 s to 0.1 s	A numeric value defining the exclusion duration interval within the time slot. The default value is 0 s. Units are resolved to 50 ns.

Example

```
LIST:TSL:EXCL:TIME 0.01      Sets the exclusion duration interval to 0.01 s.
```

Reset condition

On reset, the value is 0 s.

Error messages

- If DET:FUNC is set to AVER, error –221, “Settings conflict” occurs.
- If the limits of the values are exceeded, error –222, “Data out of range;value clipped to upper (or lower) limit” occurs.
- If LIST:TSL:EXCL:TIME is set while a sequence is running, error –221, “Settings conflict;list mode is running” occurs.

[1] Applicable for U2042XA/U2044XA/U2049XA only.

[:SENSe[1]:]LIST:TSLot:TIME^[1]

Syntax

```
[:SENSe[1]:]LIST:TSLot:TIME <numeric_value>
```

```
[:SENSe[1]:]LIST:TSLot:TIME?
```

Description

This command is used to set the duration of the measurement time slot.

The query returns the current measurement time slot.

Parameter

Item	Range of values	Description/Default value
numeric_value	50 ns to 1 s	A numeric value defining the measurement time slot. The default value is 100 μ s. Units are resolved to 50 ns.

Example

```
LIST:TSL:TIME 0.01
```

Sets the measurement time slot to 0.01 s.

Reset condition

On reset, the value is 100 μ s.

Error messages

- If DET:FUNC is set to AVER, error -221, "Settings conflict" occurs.
- If the limits of the values are exceeded, error -222, "Data out of range;value clipped to upper (or lower) limit" occurs.
- If the product of the LIST:TSL:TIME value multiplied by the LIST:TSC value exceeds 1 s, error -221, "Settings conflict;Capture buffer size too large. Please reduce time slot duration or count." occurs.
- If LIST:TSL:TIME is set while a sequence is running, error -221, "Settings conflict;list mode is running" occurs.

[1] Applicable for U2042XA/U2044XA/U2049XA only.

[:SENSe[1]:]LIST:TSLot:TREF1^[1]

Syntax

```
[:SENSe[1]:]LIST:TSLot:TREF1 <numeric_value>
```

```
[:SENSe[1]:]LIST:TSLot:TREF1?
```

Description

This command is used to set the measurement gate start time within the time slot (in % of the slot duration). The measurement gate start time defines the percentage of the time slot (relative to the beginning of the slot) to be excluded from the measurement. This is useful for removing rising edges and overshoots.

The query returns the current measurement gate start time slot.

Parameter

Item	Range of values	Description/Default value
numeric_value	0.0% to 100.0%	A numeric value defining the measurement gate start time within the time slot. The default value is 0. Units are resolved to 0.1%.

Example

```
LIST:TSL:TREF1 10.0
```

Sets the measurement gate start time slot to 10.0%.

Reset condition

On reset, the value is 0.

Error messages

- If `DET:FUNC` is set to `AVER`, error –221, “Settings conflict” occurs.
- If the limits of the values are exceeded, error –222, “Data out of range;value clipped to upper (or lower) limit” occurs.
- If `LIST:TSL:TREF1` is set while a sequence is running, error –221, “Settings conflict;list mode is running” occurs.

[1] Applicable for U2042XA/U2044XA/U2049XA only.

[:SENSe[1]:]LIST:TSLot:TREF2^[1]

Syntax

```
[:SENSe[1]:]LIST:TSLot:TREF2 <numeric_value>
```

```
[:SENSe[1]:]LIST:TSLot:TREF2?
```

Description

This command is used to set the measurement gate end time within the time slot (in % of the slot duration). The measurement gate end time defines the percentage of the time slot (relative to the end of the slot) to be excluded from the measurement. This is useful for removing falling edges and undershoots.

The query returns the current measurement gate end time slot.

Parameter

Item	Range of values	Description/Default value
numeric_value	0.0% to 100.0%	A numeric value defining the measurement gate end time within the time slot. The default value is 0. Units are resolved to 0.1%.

Example

```
LIST:TSL:TREF2 10.0
```

Sets the measurement gate end time slot to 10.0%.

Reset condition

On reset, the value is 0.

Error messages

- If DET:FUNC is set to AVER, error –221, “Settings conflict” occurs.
- If the limits of the values are exceeded, error –222, “Data out of range;value clipped to upper (or lower) limit” occurs.
- If LIST:TSL:TREF2 is set while a sequence is running, error –221, “Settings conflict;list mode is running” occurs.

[1] Applicable for U2042XA/U2044XA/U2049XA only.

[:SENSe[1]:]MRATe

Syntax

```
[:SENSe[1]:]MRATe <character_data>
[:SENSe[1]:]MRATe?
```

Description

This command sets the measurement speed.

When the U2040 X-Series is set to FAST, the following couplings occur:

Command	Status
[:SENSe[1]:]AVERAge:STATe	OFF ^[a]
[:SENSe[1]:]CORRection:GAIN2:STATe	OFF ^[a]
CALCulate[1] 2 3 4:GAIN:STATe	OFF ^[a]
CALCulate[1] 2 3 4:RELative:STATe	OFF ^[a]
CALCulate[1] 2 3 4:MATH:EXPRession	"(SENSe1)"

[a] This change occurs when setting the U2040 X-Series to FAST. When changing from FAST to NORMAl or DOUBLe, the settings that were in place when FAST was entered are restored.

The query returns the current speed setting of either NORMAl, DOUBLe, or FAST.

Parameter

Item	Range of values	Description/Default value
character_data	NORMAl ^[a] DOUBLe ^[a] FAST	A value for the measurement speed: - NORMAl: 20 readings/second - DOUBLe: 40 readings/second - FAST: approximately 3500 readings/second ^[b] The default value is NORMAl.

[a] When the channel is set to NORMAl or DOUBLe, TRIG:COUNT is automatically set to 1.

[b] Approximately 3500 readings/second for DET:FUNC NORM only. For DET:FUNC AVER, the throughput is equal to 1/aperture size (SENS:SWE:APER).

Example

`MRAT DOUB` Sets the speed to 40 readings/second.

Reset condition

On reset, the speed is set to `NORMa1`.

Error message

If `<character_data>` is not set to `NORMa1`, `DOUB1e`, or `FAST`, error -224, “Illegal parameter value” occurs.

[:SENSe[1]:]SWEep:[1]|2|3|4:AUTO^[1]

Syntax

```
[:SENSe[1]:]SWEep[1]|2|3|4:AUTO ON|OFF|1|0|ONCE
[:SENSe[1]:]SWEep[1]|2|3|4:AUTO?
```

Description

This command is used to trigger Auto Gating and to turn on or off the Perpetual Gating for the selected gate.

- ONCE: To turn on Auto Gating
- ON|OFF|1|0: To turn on/off Perpetual Gating

NOTE

This command is only applicable when TRIG:SOUR is set to INT or EXT.

The query returns the current setting of the perpetual gating (0 or 1).

- 1 is returned if the perpetual gating is turned on
- 0 is returned if the perpetual gating is turned off

Example

```
SWE2:AUTO ON      Turns on Gate 2 Perpetual Gating.
```

Reset condition

On reset, Perpetual Gating will be disabled.

Error messages

- If TRIG:SOUR is not set to INT or EXT, error -221, "Settings conflict" occurs.
- If DET:FUNC is set to AVER, error -221, "Settings conflict" occurs.
- If Auto Gate fails, error -221, "Settings conflict;Auto Once failed" occurs.
- If this command is set to ON or ONCE while LIST:STAT is set to ON, error -221, "Settings conflict;list mode is enabled" occurs.

[1] Applicable for U2042XA/U2044XA/U2049XA only.

```
[ :SENSe[1]: ]SWEep[1]|2|3|4:AUTO:REF1|REF2[1]
```

Syntax

```
[ :SENSe[1]: ]SWEep[1]|2|3|4:AUTO:REF1|REF2 <numeric_value>
[ :SENSe[1]: ]SWEep[1]|2|3|4:AUTO:REF1|REF2?
```

Description

This command is used to set the Reference 1 and 2 of the selected gate for Auto Gating Marker.

NOTE

This command is only applicable when `TRIG:SOUR` is set to `INT` or `EXT`.

The query returns the current setting of Auto Gating Marker Reference 1 or 2 for the selected gate in numerical value.

Parameter

Item	Range of values	Description/Default value
numeric_value	0.0 to 99.9	The values of Auto Gating Marker Reference 1 and 2 for the selected gate. The combined value of REF1 and REF2 cannot exceed 99.9%.

Example

```
SWE:AUTO:REF1 10.0 Sets the Auto Gating Marker Reference 1 to 10% for Gate 1.
```

Error messages

- If `TRIG:SOUR` is not set to `EXTeRnal` or `INTeRnal`, error -221, “Settings conflict” occurs.
- If `DET:FUNC` is set to `AVeR`, error -221, “Settings conflict” occurs.
- If the combined value of `REF1` and `REF2` exceeds 99.9%, error -222, “Data out of range” occurs.

[1] Applicable for U2042XA/U2044XA/U2049XA only.

[:SENSE[1]:]SWEep[1]|2|3|4:OFFSet:TIME^[1]

Syntax

```
[:SENSE[1]:]SWEep[1]|2|3|4:OFFSet:TIME <numeric_value>
```

```
[:SENSE[1]:]SWEep[1]|2|3|4:OFFSet:TIME?
```

Description

This command sets the delay between the delayed trigger point and the start of the time-gated period (the offset time).

NOTE

This command will not be applicable if Perpetual Gating is enabled for the selected gate.

The query returns the current delay between the trigger point and the start of the time-gated period.

Parameter

Item	Range of values	Description/Default value
numeric_value	-1 to 1 s DEF	The delay between the trigger point and the start of the time-gated period. - DEF: the default value is 0 s Units are resolved to 50 ns.

Example

```
SWE3:OFFS:TIME 0.001      Sets the delay to 0.001 s.
```

Reset condition

On reset, the value is set to 0 s.

Error messages

- If DET:FUNC is set to AVER, error -221, "Settings conflict" occurs.
- If SWEep:AUTO is set to ON for the selected gate, error -221, "Settings conflict" occurs.

[1] Applicable for U2042XA/U2044XA/U2049XA only.

[:SENSe[1]:]SWEep[1]|2|3|4:TIME^[1]

Syntax

```
[:SENSe[1]:]SWEep[1]|2|3|4:TIME <numeric_value>
```

```
[:SENSe[1]:]SWEep[1]|2|3|4:TIME?
```

Description

This command sets the duration of the time-gated period (gate length) for time-gated measurements.

NOTE

This command will not be applicable if Perpetual Gating is enabled for the selected gate.

The query returns the current length of the time-gated period.

Parameter

Item	Range of values	Description/Default value
numeric_value	0 to 1 s DEF	The duration of the time-gated period in seconds. - DEF: the default value is 100 μ s Units are resolved to 50 ns.

Example

```
SWE3:TIME 0.001           Sets the length to 0.001 s.
```

Reset condition

On reset, gate 1 is set to 100 μ s and other gates to 0 s.

Error messages

- If DET:FUNC is set to AVER, error -221, "Settings conflict" occurs.
- If SWEep:AUTO is set to ON for the selected gate, error -221, "Settings conflict" occurs.

[1] Applicable for U2042XA/U2044XA/U2049XA only.

[:SENSE[1]:]SWEep:APERture

Syntax

```
[:SENSE[1]:]SWEep:APERture <numeric_value>
[:SENSE[1]:]SWEep:APERture? [MIN|MAX]
```

Description

This command sets the aperture duration or measurement interval.

NOTE

Entering a value using this command automatically sets the [:SENSE[1]:]SWEep:APERture:AUTO to OFF.

The query returns the current aperture duration or the value associated with MIN and MAX.

Parameter

Item	Range of values	Description/Default value
numeric_value	20E-6 ^[a] to 200E-3 s DEF MIN MAX	The aperture duration in seconds. - DEF: the default value is 50E-3 - MIN: 20E-6 ^[a] - MAX: 200E-3 Units are resolved to 100 ns.

[a] Only applicable for ≥ 300 MHz. For < 300 MHz, the minimum aperture size is 50 μ s. If the existing aperture size is set to < 50 μ s and the frequency is changed from ≥ 300 MHz to < 300 MHz, the aperture size will automatically be changed to 50 μ s.

Example

```
SWE:APER 10E-3           Sets the aperture duration to 10 ms.
```

Reset condition

On reset, the aperture duration is set to 50 ms.

Error messages

- If the limits of the values are exceeded, error -222, "Data out of range" occurs.
- If `SENS:SWE:APER` is set when `SENS:DET:FUNC` is set to `NORM` or when `SENS:MRAT` is not set to `NORM`, error -221, "Settings conflict" occurs.
- If `SENS:SWE:APER` is set to $<50 \mu\text{s}$ (for ≥ 300 MHz) and the frequency is then changed to <300 MHz, the aperture duration will automatically be changed to $50 \mu\text{s}$ with error -221, "Settings conflict;Aperture size too small. Changing to a minimum."

[:SENSE[1]:]SWEep:APERture:AUTO

Syntax

```
[:SENSE[1]:]SWEep:APERture:AUTO ON|OFF|1|0
[:SENSE[1]:]SWEep:APERture:AUTO?
```

Description

This command enables and disables automatic selection of the aperture duration or measurement interval.

Setting this command to ON will automatically select the aperture duration corresponding to the current measurement rate.

Measurement rate	Aperture duration
NORMAL: 20 readings/s	50 ms
DOUBLE: 40 readings/s	25 ms
FAST: Up to 500 readings/s	2 ms

The query returns a 1 or 0 into the output buffer indicating whether automatic selection of the aperture duration is enabled or disabled.

- 1 is returned when automatic selection of the aperture duration is enabled.
- 0 is returned when automatic selection of the aperture duration is disabled.

Example

```
SWE:APER:AUTO OFF
```

Disables automatic selection of the aperture duration.

Reset condition

On reset, automatic selection of the aperture duration is enabled.

Error message

If this command is enabled when SENS:DET:FUNC is set to NORM, error -221, "Settings conflict" occurs.

[:SENSe[1]:]TEMPerature?

Syntax

```
[ :SENSe[1] : ]TEMPerature?
```

Description

This query returns the U2040 X-Series bulkhead temperature in degree Celsius.

Example

```
TEMP? Returns the current U2040 X-Series bulkhead temperature.
```

Reset condition

On reset, this parameter is not affected.

[:SENSE[1]:]TRACe:MEMemory:SIZE^[1]

Syntax

```
SENSE:TRACe:MEMemory:SIZE [DEFault | LMEM]
SENSE:TRACe:MEMemory:SIZE?
```

Description

This command is to enable long acquisition trace memory using TRAC? LMEM. Setting this command will prepare the enlarge memory size to store for trace data.

Upon power up, this command is set to DEFault value. Default memory size setting will support parameter of HRES, MRES and LRES only in TRACe[1] [:DATA]?<character_data> command.

When using this command switch from DEFault to LMEM, it will affect the following setting:

```
SENSE:TRACe:TIME 1s (min/max range become -10E-3 to 1 s)
```

```
SENSE:TRACe:OFFSet:TIME 0 (min/max range become -10E-3 to 1 s)
```

```
TRIGger:DElay 0
```

Sum of SENSE:TRACe:OFFSet:TIME and TRIGger:DElay cannot exceed range of -10E-3 to 1 s.

Reset condition

On reset, the trace memory size is set to Default size.

[1] Applicable for U2049XA only.

Error messages

- If `TRAC:STAT` is off, error -221, "Settings conflict" occurs.
- If this command is used when `SENSe:DET:FUNC` is set to `AVER`, error -221, "Settings conflict" occurs.
- If `TRIG:DEL` is set to value out of the range 10E-3 to 1 s, "TRIG:DEL limit exceeded for SENS:TRAC:MEM:SIZE LMEM; no change." occurs.
- If `TRAC:OFFS:TIME` is set to value out of the range 10E-3 to 1 s, "TRAC:OFFS:TIME limit exceeded for SENS:TRAC:MEM:SIZE LMEM ; no change." occurs.
- If the sum of `SENS:TRAC:OFFS:TIME` and `TRIG:DEL` is out of the range -10E-3 to 1 s, "[TRIG:DEL + TRAC:OFFS:TIME] limit exceeded for SENS:TRAC:MEM:SIZE LMEM ; no change" occurs.

[:SENSE[1]:]TRACe:OFFSet:TIME^[1]

Syntax

```
[:SENSE[1]:]TRACe:OFFSet:TIME <numeric_value>
[:SENSE[1]:]TRACe:OFFSet:TIME?
```

Description

This command sets the delay between the delayed trigger point and the start of the trace for the U2040 X-Series.

The query returns the current delay between the delayed trigger point and the start of the trace.

Parameter

Item	Range of values	Description/Default value
numeric_value	-1 to 1 s DEF	The length of the delay in seconds. - DEF: the default value is 0 s Units are resolved to 50 ns.

NOTE

When SENS:TRAC:MEM:SIZE is LMEM, the range is from -10E-3 to 1 s. For more details, refer to “[:SENSE[1]:]TRACe:MEMemory:SIZE” on page [272](#).

Example

```
TRAC:OFFS:TIME 0.05           Sets the delay to 0.05 s.
```

Reset condition

On reset, the delay is set to 0 s.

Error message

If DET:FUNC is set to AVER, error -221, “Settings conflict” occurs.

[1] Applicable for U2042XA/U2044XA/U2049XA only.

[:SENSe[1]:]TRACe:TIME^[1]

Syntax

```
[:SENSe[1]:]TRACe:TIME <numeric_value>
[:SENSe[1]:]TRACe:TIME?
```

Description

This command sets the duration of the trace for the U2040 X-Series.

The query returns the current duration of the trace.

Parameter

Item	Range of values	Description/Default value
numeric_value	100 ns to 1 s DEF	The length of the trace in seconds. - DEF: the default value is 100 μ s Units are resolved to 50 ns.

Example

```
TRAC:TIME 0.5
```

Sets the duration of the trace to 0.5 s.

Reset condition

On reset, the duration is set to 100 μ s.

Error message

If DEF:FUNC is set to AVER, error -221, "Settings conflict" occurs.

[1] Applicable for U2042XA/U2044XA/U2049XA only.

[:SENSe[1]:]TRACe:UNIT^[1]

Syntax

```
[:SENSe[1]:]TRACe:UNIT DBM|W  
[:SENSe[1]:]TRACe:UNIT?
```

Description

This command sets the unit for the trace.

The query returns the current trace unit.

Example

```
TRAC:UNIT W           Sets the trace unit to watts.
```

Reset condition

On reset, the unit is set to dBm.

[1] Applicable for U2042XA/U2044XA/U2049XA only.

[:SENSe[1]:]TRACe:AUToscale^[1]

Syntax

```
[ :SENSe[1]: ]TRACe:AUToscale
```

Description

This command automatically scales the trace capture to between 20% to 50% of the x-scale (time axis) with the triggering edge aligned to the center of the trace. This means that the trigger level, trigger delay, holdoff, and gate 1 to 4 duration and offset will be overwritten. Additionally, upon successful autoscaling, the trigger source will be set to INT, and INIT:CONT will remain unchanged. Perpetual gating will also be disabled.

Example

```
TRAC:AUT           Automatically scales the trace capture.
```

Error messages

- If SENS:TRAC:AUT is set while DET:FUNC is set to AVER, error -221, "Settings conflict" occurs.
- If SENS:TRAC:AUT is set while TRAC:STAT is set to OFF, error -221, "Settings conflict" occurs.
- If SENS:TRAC:AUT is set while TRIG:SOUR is set to EXT, error -221, "Settings conflict" occurs.

[1] Applicable for U2042XA/U2044XA/U2049XA only.

THIS PAGE HAS BEEN INTENTIONALLY LEFT BLANK.

Keysight U2040 X-Series

Wide Dynamic Range Power Sensors

Programming Guide

17 SERVICE Subsystem

SERVICE:BIST:CW:ZSET:NUMBER?	280
SERVICE:BIST:PEAK[1]:LINEARITY	281
SERVICE:BIST:PEAK[1]:LINEARITY:PERROR?	282
SERVICE:BIST:PEAK[1]:ZSET	283
SERVICE:BIST:PEAK[1]:ZSET:NUMBER?	284
SERVICE:BIST:RAM:MODE <character_data>	285
SERVICE:BIST:TBASe:STATe	286
SERVICE:LAN:PHOStname	287
SERVICE:SECure:ERASe	288
SERVICE:SENSor[1]:CDATe?	289
SERVICE:SENSor[1]:CPLace?	290
SERVICE:SENSor[1]:FREQuency:MAXimum?	291
SERVICE:SENSor[1]:FREQuency:MINimum?	292
SERVICE:SENSor[1]:POWer:AVERage:MAXimum?	293
SERVICE:SENSor[1]:POWer:PEAK:MAXimum?	294
SERVICE:SENSor[1]:POWer:USABLE:MAXimum?	295
SERVICE:SENSor[1]:POWer:USABLE:MINimum?	296
SERVICE:SENSor[1]:RADC?	297
SERVICE:SENSor[1]:SNUMBER?	298
SERVICE:SENSor[1]:TYPE?	299
SERVICE:SNUMBER?	300

This chapter describes the SERVICE subsystem commands.

SERVICE:BIST:CW:ZSET:NUMBER?

Syntax

```
SERVICE:BIST:CW:ZSET:NUMBER?
```

Description

This query returns the worst case error in the CW zero test invoked by the `SERVICE:BIST:PEAK[1]:ZSET` command.

Example

```
SERV:BIST:CW:ZSET:NUM?
```

Queries the worst case error in the CW zero test.

SERvice:BIST:PEAK[1]:LINearity^[1]

Syntax

```
SERvice:BIST:PEAK[1]:LINearity
```

Description

This command initiates the PEAK linearity test.

NOTE

Device Clear can be used to abort the PEAK linearity test. The "Self-Test Started" operation status bit can be used to check the status of the test.

Example

```
SERV:BIST:PEAK:LIN
```

Initiates the PEAK linearity test.

[1] Applicable for U2042XA/U2044XA/U2049XA only.

SERVICE:BIST:PEAK[1]:LINEarity:PERRor?[1]

Syntax

```
SERVICE:BIST:PEAK[1]:LINEarity:PERRor?
```

Description

This query returns the PEAK linearity worst case error.

Example

```
SERV:BIST:PEAK:LIN:PERR?    Queries the PEAK linearity worst case error.
```

[1] Applicable for U2042XA/U2044XA/U2049XA only.

SERvice:BIST:PEAK[1]:ZSET^[1]

Syntax

```
SERvice:BIST:PEAK[1]:ZSET
```

Description

This command initiates the zero set and noise test for both peak and CW signals.

NOTE

- Ensure that the U2040 X-Series is not connected to the RF source when performing the test.
- Device Clear can be used to abort the PEAK zero set and noise test. The "Self-Test Started" operation status bit can be used to check the status of the test.

Example

```
SERV:BIST:PEAK:ZSET
```

Enables the zero set and noise test.

[1] Applicable for U2042XA/U2044XA/U2049XA only.

SERVICE:BIST:PEAK[1]:ZSET:NUMBER?[1]

Syntax

```
SERVICE:BIST:PEAK[1]:ZSET:NUMBER?
```

Description

This query returns the worst case error in the PEAK zero test invoked by SERVICE:BIST:PEAK[1]:ZSET.

Example

```
SERV:BIST:PEAK:ZSET:NUM?      Queries the worst case error in the PEAK zero test.
```

[1] Applicable for U2042XA/U2044XA/U2049XA only.

SERvice:BIST:RAM:MODE <character_data>

Syntax

```
SERvice:BIST:RAM:MODE <character_data>
SERvice:BIST:RAM:MODE?
```

Description

This command sets the mode of the RAM self-test during U2040 X-Series power-on. The result of the RAM self-test will be verified when *TST? is executed.

The query returns the current RAM self-test mode.

Parameter

Item	Range of values	Description/Default value
character_data	OFF MINimum FULL	RAM self-test mode: - OFF: the RAM self-test is turned off during power-on. This is the default setting. - MINimum: the RAM self-test will run a minimum set of tests during power-on - FULL: the RAM self-test will run a full set of tests during power-on

Example

```
SERV:BIST:RAM:MODE MIN    Sets the RAM self-test mode to Minimum.
```

Reset condition

On reset, the RAM self-test mode is set to OFF.

Error message

If <character_data> is not set to OFF, MINimum, or FULL, error -224, "Illegal parameter value" occurs.

SERVICE:BIST:TBASe:STATe

Syntax

```
SERVICE:BIST:TBASe:STATe ON|OFF|1|0
SERVICE:BIST:TBASe:STATe?
```

Description

This command enables the 10 MHz timebase signal on the Trig Out port for testing purposes.

NOTE

The `OUTPUT:TRIGGER[:STATE]` command overrides the `SERVICE:BIST:TBASe:STATe` command.

For example, if `SERVICE:BIST:TBASe:STATe` is `ON` and the `OUTPUT:TRIGGER[:STATE] ON` command is sent, this command overrides the timebase state and sets it to `OFF`.

If `OUTPUT:TRIGGER[:STATE]` is `ON` and `SERVICE:BIST:TBASe:STATe ON` is sent, the timebase signal is now routed to the Trig Out port overriding the channel trigger output command turning the trigger output off.

If the command is set to:

- `ON/1`, the 10 MHz timebase signal is enabled on the Trig Out connector.
- `OFF/0`, the 10 MHz timebase signal is disabled.

The query indicates the status of the 10 MHz timebase.

- `1` is returned when the 10 MHz timebase signal is enabled.
- `0` is returned when the 10 MHz timebase signal is disabled.

Example

```
SERV:BIST:TBAS:STAT OFF      Disables the 10 MHz timebase signal.
```

Reset condition

On reset, the 10 MHz timebase signal is disabled.

SERvice:LAN:PHOSname^[1]

Syntax

```
SERvice:LAN:PHOSname
```

Description

This command presets the LAN hostname to its default value.

The format of the default value is “K-” + model number + “-” + last five digits of the instrument serial number:

```
K-U2049XA-XXXXX
```

Example

```
SERV:LAN:PHOS
```

The command presets the LAN hostname to its default value.

[1] Applicable for U2049XA only.

SERVICE:SECure:ERASe

Syntax

```
SERVICE:SECure:ERASe
```

Description

This command sanitizes the power sensor memory, for example, before you return it to Keysight for repair or calibration, of all data stored in it.

The memory data sanitized includes the save/recall states, FDO tables, Gamma tables, and S-Parameter tables.

Example

```
SERV:SEC:ERAS      Erases the power sensor memory.
```

SERvice:SENSor[1]:CDATe?

Syntax

```
SERvice:SENSor[1]:CDATe?
```

Description

This query returns the calibration date. The calibration date information is stored in the U2040 X-Series EEPROM.

Example

```
SERV:SENS:CDAT? Returns the calibration date.
```

SERVICE:SENSOR[1]:CPLace?

Syntax

```
SERVICE:SENSOR[1]:CPLace?
```

Description

This query returns the place of calibration. The calibration place information is stored in the U2040 X-Series EEPROM.

Example

```
SERV:SENS:CPL?           Returns the place of calibration.
```

SERvice:SENSor[1]:FREQuency:MAXimum?

Syntax

```
SERvice:SENSor[1]:FREQuency:MAXimum?
```

Description

This query returns the maximum frequency that can be measured by the U2040 X-Series.

Example

```
SERV:SENS:FREQ:MAX?
```

Returns the maximum frequency that can be measured by the U2040 X-Series.

Error message

If the U2040 X-Series contains an invalid model number programmed into the EEPROM, error -56, "System error. Invalid sensor model number." occurs.

SERVICE:SENSOR[1]:FREQUENCY:MINIMUM?

Syntax

```
SERVICE:SENSOR[1]:FREQUENCY:MINIMUM?
```

Description

This query returns the minimum frequency that can be measured by the U2040 X-Series.

Example

```
SERV:SENS:FREQ:MIN?
```

Returns the minimum frequency that can be measured by the U2040 X-Series.

Error message

If the U2040 X-Series contains an invalid model number programmed into the EEPROM, error -56, "System error. Invalid sensor model number." occurs.

SERvice:SENSor[1]:POWer:AVERage:MAXimum?

Syntax

```
SERvice:SENSor[1]:POWer:AVERage:MAXimum?
```

Description

This query returns the maximum average power that can be measured by the U2040 X-Series.

Example

```
SERV:SENS:POW:AVER:MAX?
```

Returns the maximum average power that can be measured by the U2040 X-Series.

Error message

If the U2040 X-Series contains an invalid model number programmed into the EEPROM, error -56, "System error. Invalid sensor model number." occurs.

SERVICE:SENSOR[1]:POWER:PEAK:MAXIMUM?[1]

Syntax

```
SERVICE:SENSOR[1]:POWER:PEAK:MAXIMUM?
```

Description

This query returns the maximum peak power that can be measured by the U2040 X-Series.

Example

```
SERV:SENS:POW:PEAK:MAX?      Returns the maximum peak power that can be  
                               measured by the U2040 X-Series.
```

Error message

If the U2040 X-Series contains an invalid model number programmed into the EEPROM, error -56, "System error. Invalid sensor model number." occurs.

[1] Applicable for U2042XA/U2044XA/U2049XA only.

SERvice:SENSor[1]:POWer:USABLE:MAXimum?

Syntax

```
SERvice:SENSor[1]:POWer:USABLE:MAXimum?
```

Description

This query returns the maximum power that can be accurately measured by the U2040 X-Series.

Example

```
SERV:SENS:POW:USAB:MAX?
```

Returns the maximum power that can be accurately measured by the U2040 X-Series.

Error message

If the U2040 X-Series contains an invalid model number programmed into the EEPROM, error -56, "System error. Invalid sensor model number." occurs.

SERVICE:SENSOR[1]:POWER:USABLE:MINIMUM?

Syntax

```
SERVICE:SENSOR[1]:POWER:USABLE:MINIMUM?
```

Description

This query returns the minimum power that can be accurately measured by the U2040 X-Series.

Example

```
SERV:SENS:POW:USAB:MIN? Returns the minimum power that can be accurately  
measured by the U2040 X-Series.
```

Error message

If the U2040 X-Series contains an invalid model number programmed into the EEPROM, error -56, "System error. Invalid sensor model number." occurs.

SERvice:SENSor[1]:RADC?

Syntax

```
SERvice:SENSor[1]:RADC?
```

Description

This query returns a new raw uncorrected measurement in volts, as a 32-bit signed integer.

Example

```
SERV:SENS:RADC?           Returns a new raw uncorrected measurement.
```

Error message

If `INIT:CONT` is set to `ON`, error `-221`, "Settings conflict" occurs.

SERVICE:SENSOR[1]:SNUMBER?

Syntax

```
SERVICE:SENSOR[1]:SNUMBER?
```

Description

This query returns the U2040 X-Series serial number. The serial number information is stored in the U2040 X-Series EEPROM.

Example

```
SERV:SENS:SNUM?           Returns the U2040 X-Series serial number.
```

SERvice:SENSor[1]:TYPE?

Syntax

```
SERvice:SENSor[1]:TYPE?
```

Description

This query identifies the connected sensor type and returns the model number stored in the EEPROM.

Example

```
SERV:SENS:TYPE?
```

Returns the connected sensor model number.

SERVICE:SNUMBER?

Syntax

```
SERVICE:SNUMBER?
```

Description

This query returns the U2040 X-Series serial number. The serial number information is stored in the U2040 X-Series EEPROM.

Example

```
SERV:SNUM?
```

Returns the U2040 X-Series serial number.

Keysight U2040 X-Series
Wide Dynamic Range Power Sensors
Programming Guide

18 STATus Subsystem

STATus Subsystem	302
Status Register Set Commands	304
Device Status Register Sets	307
Operation Register Sets	308
STATus:OPERation	309
STATus:OPERation:CALibrating[:SUMMARY]	310
STATus:OPERation:LLFail[:SUMMARY]	311
STATus:OPERation:MEASuring[:SUMMARY]	312
STATus:OPERation:SENSe[:SUMMARY]	313
STATus:OPERation:TRIGger[:SUMMARY]	314
STATus:OPERation:ULFail[:SUMMARY]	315
STATus:PRESet	316
Questionable Register Sets	317
STATus:QUEStionable	318
STATus:QUEStionable:CALibration[:SUMMARY]	319
STATus:QUEStionable:POWer:CHA	320
STATus:QUEStionable:POWer[:SUMMARY]	321

This chapter describes the STATus subsystem commands.

STATus Subsystem

The STATus command subsystem enables you to examine the status of the U2040 X-Series by monitoring the following status registers:

- Device status register
- Operation status register
- Questionable status register

The contents of these and other registers in the U2040 X-Series are determined by one or more status registers.

Table 18-1 summarizes the effects of various commands and events on these status registers:

Table 18-1 Commands and events affecting the status register

Status register	*RST	*CLS	Power on	STATus:PRESet
SCPI Transition Filters (NTR and PTR registers)	none	none	preset	preset
SCPI Enable Registers	none	none	preset	preset
SCPI Event Registers	none	clear	clear	none
SCPI Error/Event Queue enable	none	none	preset	preset
SCPI Error/Event Queue	none	clear	clear	none
IEEE 488.2 Registers ESE SRE	none	none	clear	none
IEEE 488.2 Registers ESR STB	none	clear	clear	none

The contents of the status registers are examined using the following status register set commands:

- :CONDition?
- :ENABle <NRf>|<non-decimal numeric>
- [:EVENT?]
- :NTRansition <NRf>|<non-decimal numeric>
- :PTRansition <NRf>|<non-decimal numeric>

Each of these can be used to examine any of the following status registers:

- STATus:DEVICE
- STATus:OPERation
- STATus:OPERation:CALibrating[:SUMMary]
- STATus:OPERation:LLFail[:SUMMary]

- STATus:OPERation:MEASuring[:SUMMARY]
- STATus:OPERation:SENSe[:SUMMARY]
- STATus:OPERation:TRIGger[:SUMMARY]
- STATus:OPERation:ULFai[:SUMMARY]
- STATus:PRESet
- STATus:QUEStionable
- STATus:QUEStionable:CALibration[:SUMMARY]
- STATus:QUEStionable:POWer:CHA
- STATus:QUEStionable:POWer[:SUMMARY]

Examples

To use the :CONDition? command to examine the STATus:DEVIce register:

```
STATus:DEVIce:CONDition?
```

To use the :NTRansition command to examine the
STATus:OPERation:SENSe[:SUMMARY] register:

```
STATus:OPERation:SENSe[:SUMMARY]:NTRansition
```

Status Register Set Commands

This section describes the five status register set commands. Each can be used to examine all of the status registers listed on [page 302](#).

To apply a command to a specific register, prefix the command with the name of the appropriate register. For example, to apply the `:ENABle` command to the `STATus:QUESTionable` register, use the following command:

```
STATus:QUESTionable:ENABle
```

:CONDition?

This query returns a 16-bit decimal-weighted number representing the bits set in the Condition Register of the SCPI Register Set you require to control. The format of the return is `<NR1>` in the range of 0 to 32767 ($2^{15}-1$). The contents of the Condition Register remain unchanged after it is read.

[:EVENT]?

This query returns a 16-bit decimal-weighted number representing the bits set in the Event Register of the SCPI Register Set you require to control.

The format of the return is `<NR1>` in the range of 0 to 32767 ($2^{15}-1$). This query clears all bits in the register to 0.

NOTE

`[:EVENT]?` is the default command if the `STATus` SCPI is not accompanied by any of the Status Register Set commands (`:COND`, `:ENAB`, `:NTR`, and `:PTR`).

:ENABle <NRf>|<non-decimal numeric>

This command sets the Enable Register of the particular SCPI Register Set you require to control. The parameter value, when rounded to an integer and expressed in base 2 has its first 15 bits written into the Enable Register of the SCPI Register Set concerned. The last bit (bit 15) is always set to 0.

Parameters

Item	Range of values	Description/Default value
NRf	0 to $2^{16}-1$	The value used to set the Enable Register.
non-decimal numeric		

Query

:ENABle?

The query returns a 15-bit decimal-weighted number representing the contents of the Enable Register of the SCPI Register Set being queried.

The format of the return is <NR1> in the range of 0 to 32767 ($2^{15}-1$).

:NTRansition <NRf>|<non-decimal numeric>

This command sets the Negative Transition Register of the SCPI Register Set you require to control. The parameter value, when rounded to an integer and expressed in base 2 has its first 15 bits written into the Negative Transition Register of the SCPI Register Set concerned. The last bit (bit 15) is always set to 0.

Parameters

Item	Range of values	Description/Default value
NRf	0 to $2^{16}-1$	The value used to set the NTR Register.
non-decimal numeric		

Query

:NTRansition?

The query returns a 15-bit decimal-weighted number representing the contents of the Negative Transition Register of the SCPI register set being queried. The format of the return is <NR1> in the range of 0 to 32767 ($2^{15}-1$).

:PTRansition <NRf>|<non-decimal numeric>

This command is used to set the Positive Transition Register of the SCPI Register Set you require to control. The first 15 bits of the input parameter are written into the Positive Transition Register of the SCPI Register Set concerned. The last bit (bit 15) is always set to 0.

Parameters

Item	Range of values	Description/Default value
NRf	0 to $2^{16}-1$	The value used to set the PTR Register.
non-decimal numeric		

Query

`:PTRansition?`

The query returns a 15-bit decimal-weighted number representing the contents of the Positive Transition Register of the SCPI register set being queried. The format of the return is `<NR1>` in the range of 0 to 32767 ($2^{15}-1$).

Device Status Register Sets

The status registers contain information which give device status information. The contents of the individual registers of these register sets may be accessed by appending the commands listed in “**Status Register Set Commands**” on page 304.

The following command descriptions detail the SCPI register you require to control but do not detail the register set commands.

The one device status register set is:

STATus:DEvice:

The following bit in these registers is used by the U2040 X-Series:

Bit number	Decimal weight	Definition
0 to 2	-	Not used
3	8	Sensor error
4 to 14	-	Not used
15	-	Not used (always 0)

The sensor error bit (3) is set to:

- 1, if the U2040 X-Series EEPROM has failed.
- 0, for every other condition.

Operation Register Sets

The following registers contain information which is part of the U2040 X-Series normal operation. The contents of the individual registers of these register sets may be accessed by appending the commands listed in “**Status Register Set Commands**” on page [304](#).

The following command descriptions detail the SCPI register you require to control but do not detail the Register Set commands.

STATus:OPERation

Syntax

STATus:OPERation

Description

The operation status register set contains conditions which are a part of the operation of the U2040 X-Series as a whole.

The following bits in these registers are used by the U2040 X-Series:

Bit number	Decimal weight	Definition
0	1	CALibrating Summary
1	2	Self-Test Started
2 to 3	-	Not used
4	16	MEASuring Summary
5	32	Waiting for TRIGger Summary
6 to 9	-	Not used
10	1024	SENSe Summary
11	2048	Lower Limit Fail Summary
12	4096	Upper Limit Fail Summary
13 to 14	-	Not used
15	-	Not used (always 0)

STATus:OPERation:CALibrating[:SUMMARY]

Syntax

```
STATus:OPERation:CALibrating[:SUMMARY]
```

Description

The operation status calibrating summary register set contains information on the calibrating status of the U2040 X-Series.

The following bit in these registers is used by the U2040 X-Series:

Bit number	Decimal weight	Definition
0	-	Not used
1	2	CALibrating Status
2 to 15	-	Not used (bit 15 is always 0)

This bit is set at the beginning of zeroing (`CALibration:ZERO:AUTO ONCE`) and at the beginning of calibration (`CALibration:AUTO ONCE`). Also for the compound command/query `CALibration[:ALL]?`, this bit is set at the beginning of the calibration sequence.

This bit is cleared at the end of zeroing or calibration.

STATus:OPERation:LLFail[:SUMMARY]

Syntax

```
STATus:OPERation:LLFail[:SUMMARY]
```

Description

The operation status lower limit fail summary register set contains information on the lower limit fail status of the U2040 X-Series.

The following bits in these registers are used by the U2040 X-Series:

Bit number	Decimal weight	Definition
0	-	Not used
1	2	SENSe LLFail Status
2	-	Not used
3	8	CALCulate1 LLFail Status
4	16	CALCulate2 LLFail Status
5	32	CALCulate3 LLFail Status
6	64	CALCulate4 LLFail Status
7 to 15	-	Not used (bit 15 is always 0)

The appropriate bits are set if a lower limit test fails.

These bits are cleared if a measurement is made and the test is enabled and passes.

STATus:OPERation:MEASuring[:SUMMARY]

Syntax

```
STATus:OPERation:MEASuring[:SUMMARY]
```

Description

The operation status measuring summary register set contains information on the measuring status of the U2040 X-Series.

The following bit in these registers is used by the U2040 X-Series:

Bit number	Decimal weight	Definition
0	-	Not used
1	2	MEASuring Status
2 to 15	-	Not used (bit 15 is always 0)

This bit is set when the U2040 X-Series is taking a measurement, and is cleared when the measurement has completed.

STATus:OPERation:SENSe[:SUMMary]

Syntax

```
STATus:OPERation:SENSe[:SUMMary]
```

Description

The operation status sense summary register set contains information on the status of the U2040 X-Series.

The following bit in these registers is used by the U2040 X-Series:

Bit number	Decimal weight	Definition
0	-	Not used
1	2	SENSe Status
2 to 15	-	Not used (bit 15 is always 0)

This bit is set when the U2040 X-Series is reading data from the EEPROM, and is cleared when the U2040 X-Series is not reading data from the EEPROM.

STATus:OPERation:TRIGger[:SUMMARY]

Syntax

```
STATus:OPERation:TRIGger[:SUMMARY]
```

Description

The operation status trigger summary register set contains information on the trigger status of the U2040 X-Series.

The following bit in these registers is used by the U2040 X-Series:

Bit number	Decimal weight	Definition
0	-	Not used
1	2	TRIGger Status
2 to 15	-	Not used (bit 15 is always 0)

This bit is set when the U2040 X-Series enters the “wait for trigger” state, and is cleared when the U2040 X-Series enters the “idle” state.

STATus:OPERation:ULFail[:SUMMARY]

Syntax

```
STATus:OPERation:ULFail[:SUMMARY]
```

Description

The operation status upper limit fail summary register set contains information on the upper limit fail status of the U2040 X-Series.

The following bits in these registers are used by the U2040 X-Series:

Bit number	Decimal weight	Definition
0	-	Not used
1	2	SENSe ULFail Status
2	-	Not used
3	8	CALCulate1 ULFail Status
4	16	CALCulate2 ULFail Status
5	32	CALCulate3 ULFail Status
6	64	CALCulate4 ULFail Status
7 to 15	-	Not used (bit 15 is always 0)

The appropriate bits are set if an upper limit test fails.

These bits are cleared if a measurement is made and the test is enabled and passes.

STATus:PRESet

Syntax

STATus:PRESet

Description

PRESet sets a number of the status registers to their preset values as shown below – all other registers are unaffected. Bit 15 is always 0.

Register	Filter/Enable	PRESet value
OPERational	ENABle	all zeros
	PTR	all ones
	NTR	all zeros
QUESTionable	ENABle	all zeros
	PTR	all ones
	NTR	all zeros
DEVice	ENABle	all zeros
	PTR	all ones
	NTR	all zeros
All others	ENABle	all ones
	PTR	all ones
	NTR	all zeros

Questionable Register Sets

The questionable register sets contain information which gives an indication of the quality of the data produced by the U2040 X-Series. The contents of the individual registers in these register sets may be accessed by appending the commands listed in “**Status Register Set Commands**” on page [304](#).

The following command descriptions detail the SCPI register you require to control but do not detail the register set commands.

STATus:QUEStionable

Syntax

STATus:QUEStionable

Description

The questionable register set contains information that indicates the quality of various aspects of signals processed by the U2040 X-Series.

The following bits in these registers are used by the U2040 X-Series:

Bit number	Decimal weight	Definition
0 to 2	-	Not used
3	8	POWer Summary
4 to 7	-	Not used
8	256	CALibration Summary
9	512	Power-On Self-Test
10 to 14	-	Not used
15	-	Not used (always 0)

- Bit 3 is set by the logical OR outputs of the STATus:QUEStionable:POWer[:SUMMARY] register set.
- Bit 8 is set by the logical OR outputs of the STATus:QUEStionable:CALibration[:SUMMARY] register set.
- Bit 9 is set if the power-on self-test fails, and cleared if it passes.

STATus:QUEStionable:CALibration[:SUMMary]

Syntax

```
STATus:QUEStionable:CALibration[:SUMMary]
```

Description

The questionable calibration summary register set contains information which gives an indication of the quality of the data produced by the U2040 X-Series due to its calibration status.

The following bit in these registers is used by the U2040 X-Series:

Bit number	Decimal weight	Definition
0	-	Not used
1	2	CALibration Summary
2 to 15	-	Not used (bit 15 is always 0)

This bit is set by the following:

- Error -231, "Data questionable;ZERO ERROR"
- Error -231, "Data questionable;CAL ERROR"

This bit is cleared when any of the above conditions succeeds and no errors are placed on the error queue.

STATus:QUEStionable:POWer:CHA

Syntax

```
STATus:QUEStionable:POWer:CHA
```

Description

The questionable power channel A register set contains information that indicates the quality of the power data being acquired by the channel A of the U2040 X-Series.

The following bit in these registers is used by the U2040 X-Series:

Bit number	Decimal weight	Definition
0	-	Not used
1	2	CHA SENSE POWer
2 to 15	-	Not used (bit 15 is always 0)

This bit is set when the following errors occur:

- Error -230, "Data corrupt or stale"
- Error -231, "Data questionable;Input Overload"

This bit is cleared when no errors or events are detected by the U2040 X-Series during a measurement covering the causes given for it to set.

STATus:QUEStionable:POWer[:SUMMary]

Syntax

STATus:QUEStionable:POWer[:SUMMary]

Description

The questionable power summary register set contains information that indicates the quality of the power data being acquired by the U2040 X-Series.

The following bits in these registers are used by the U2040 X-Series:

Bit number	Decimal weight	Definition
0	-	Not used
1	2	SENSe POWer
2	-	Not used
3	8	CALCulate1 POWer
4	16	CALCulate2 POWer
5	32	CALCulate3 POWer
6	64	CALCulate4 POWer
7 to 15	-	Not used (bit 15 is always 0)

Bit 1 is set when error -231, "Data questionable;Input Overload" occurs.

Bit 3, 4, 5, or 6 is set appropriately when the following errors occur:

- Error -230, "Data corrupt or stale"
- Error -231, "Data questionable;CALC1 log error"
- Error -231, "Data questionable;CALC2 log error"
- Error -231, "Data questionable;CALC3 log error"
- Error -231, "Data questionable;CALC4 log error"

These bits are cleared when no errors or events are detected by the U2040 X-Series during a measurement covering the causes given for it to set.

Status Block Diagram

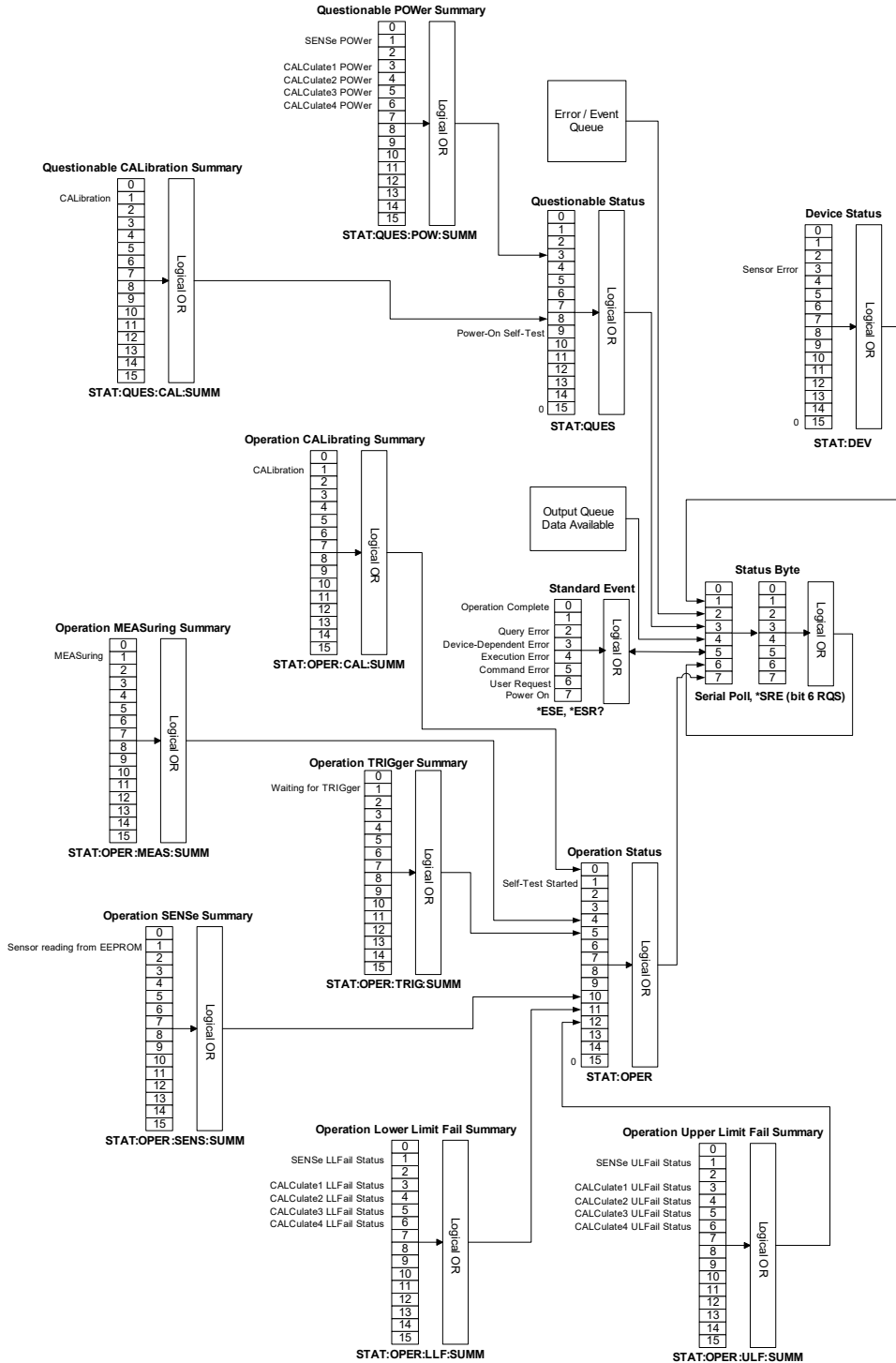

Keysight U2040 X-Series
Wide Dynamic Range Power Sensors
Programming Guide

19 SYSTEM Subsystem

SYSTEM:COMMunicate:LAN:AIP[:STATe]	324
SYSTEM:COMMunicate:LAN:DHCP[:STATe]	325
SYSTEM:COMMunicate:LAN:ADDRes	326
SYSTEM:COMMunicate:LAN:DGATeway	327
SYSTEM:COMMunicate:LAN:DNAME	328
SYSTEM:COMMunicate:LAN:HNAME	329
SYSTEM:COMMunicate:LAN:MAC	330
SYSTEM:COMMunicate:LAN:SMASK	331
SYSTEM:COMMunicate:LAN:REStart	332
SYSTEM:COMMunicate:LAN:CURRent:ADDRes?	333
SYSTEM:COMMunicate:LAN:CURRent:DGATeway?	334
SYSTEM:COMMunicate:LAN:CURRent:DNAME?	335
SYSTEM:COMMunicate:LAN:CURRent:SMASK?	336
SYSTEM:COMMunicate:LAN:KEEPalive	337
SYSTEM:ERRor?	340
SYSTEM:HELP:HEADers?	345
SYSTEM:PRESet	346
SYSTEM:SET	403
SYSTEM:VERSion?	404

This chapter describes the `SYSTEM` subsystem commands.

SYSTem:COMMunicate:LAN:AIP[:STATe]^[1]

Syntax

```
SYSTem:COMMunicate:LAN:AIP[:STATe] ON|OFF|1|0
```

```
SYSTem:COMMunicate:LAN:AIP?
```

Description

This command enables the AutoIP protocol to dynamically assign the IP address when connecting to the U2040 X-Series in an isolated (non-site) LAN network (for example, PC to U2040 X-Series).

The query enters a 1 or 0 into the output buffer indicating the AutoIP status.

- 1 is returned if AutoIP is enabled
- 0 is returned if AutoIP is disabled

Example

```
SYST:COMM:LAN:AIP ON      This command enables the AutoIP.
```

Reset condition

On reset, the AutoIP protocol is enabled.

[1] Applicable for U2049XA only.

SYSTem:COMMunicate:LAN:DHCP[:STATe]^[1]

Syntax

```
SYSTem:COMMunicate:LAN:DHCP[:STATe] ON|OFF|1|0
```

```
SYSTem:COMMunicate:LAN:DHCP?
```

Description

This command enables the dynamic host configuration protocol (DHCP).

The query enters a 1 or 0 into the output buffer indicating the DHCP status.

- 1 is returned if DHCP is enabled
- 0 is returned if DHCP is disabled

Example

```
SYST:COMM:LAN:DHCP ON      This command enables the DHCP.
```

Reset condition

On reset, DHCP is enabled.

[1] Applicable for U2049XA only.

SYSTEM:COMMunicate:LAN:ADDRESS^[1]

Syntax

```
SYSTEM:COMMunicate:LAN:ADDRESS <character_data>
```

```
SYSTEM:COMMunicate:LAN:ADDRESS?
```

Description

This command sets the LAN (IP) address of the U2040 X-Series.

The query returns the current setting of the LAN IP address.

Parameter

Item	Range of values	Description/Default value
character_data	0 to 255 (no embedded spaces)	Numeric character values for the address. Up to 15 characters, formatted as follows: A.B.C.D where A, B, C, D = 0 to 255

Example

```
SYSTEM:COMM:LAN:ADDR '130.015.156.255'
```

This command sets the LAN IP address to 130.015.156.255.

[1] Applicable for U2049XA only.

SYSTem:COMMunicate:LAN:DGATeway^[1]

Syntax

```
SYSTem:COMMunicate:LAN:DGATeway <character_data>
SYSTem:COMMunicate:LAN:DGATeway?
```

Description

This command sets the LAN IP router/gateway address for the U2040 X-Series.
The query returns the current setting of the LAN gateway address.

Parameter

Item	Range of values	Description/Default value
character_data	0 to 255 (no embedded spaces)	Numeric character values for the address. Up to 15 characters, formatted as follows: A.B.C.D where A, B, C, D = 0 to 255

Example

```
SYST:COMM:LAN:DGAT '130.2.6.200'
```

This command sets the gateway address to 130.2.6.200.

[1] Applicable for U2049XA only.

SYSTem:COMMunicate:LAN:DNAMe^[1]

Syntax

```
SYSTem:COMMunicate:LAN:DNAMe <character_data>
SYSTem:COMMunicate:LAN:DNAMe?
```

Description

This command sets the domain name for the U2040 X-Series.
The query returns the current setting of the LAN domain name.

Parameter

Item	Range of values	Description/Default value
character_data	Maximum of 16 characters	Character values of up to 16 characters

Example

```
SYST:COMM:LAN:DNAM 'myco.com'
```

This command sets the domain name to myco.com.

[1] Applicable for U2049XA only.

SYSTem:COMMunicate:LAN:HNAME^[1]

Syntax

```
SYSTem:COMMunicate:LAN:HNAME <character_data>
```

```
SYSTem:COMMunicate:LAN:HNAME?
```

Description

This command sets the host name for the U2040 X-Series.

The factory default setting of the host name is in this format:

K- + product number + - + suffix five digits of serial number (K-U2049XA-XXXXX)

The query returns the current setting of the LAN host name.

Parameter

Item	Range of values	Description/Default value
character_data	Maximum of 15 characters	Character values of up to 15 characters

Example

```
SYST:COMM:LAN:HNAME 'PSensor1'
```

This command sets the host name to PSensor1.

[1] Applicable for U2049XA only.

SYSTem:COMMunicate:LAN:MAC^[1]

Syntax

```
SYSTem:COMMunicate:LAN:MAC?
```

Description

This query returns the LAN MAC address.

Example

```
SYST:COMM:LAN:MAC?
```

This command queries the current MAC address.

[1] Applicable for U2049XA only.

SYSTem:COMMunicate:LAN:SMASk^[1]

Syntax

```
SYSTem:COMMunicate:LAN:SMASk <character_data>
```

```
SYSTem:COMMunicate:LAN:SMASk?
```

Description

This command sets the subnet mask of the U2040 X-Series.

The query returns the current setting of the LAN subnet mask.

Parameter

Item	Range of values	Description/Default value
character_data	0 to 255 (no embedded spaces)	Numeric character values for the address. Up to 15 characters, formatted as follows: A.B.C.D where A, B, C, D = 0 to 255

Example

```
SYST:COMM:LAN:SMAS `255.255.248.0`
```

This command sets the subnet mask to 255.255.248.0.

[1] Applicable for U2049XA only.

SYSTem:COMMunicate:LAN:REStart^[1]

Syntax

```
SYSTem:COMMunicate:LAN:REStart
```

Description

This command restarts the U2040 X-Series network stack; any LAN configuration changes can only take effect after this is performed.

Example

```
SYST:COMM:LAN:REST
```

This command restarts the LAN network with a new configuration.

[1] Applicable for U2049XA only.

SYSTem:COMMunicate:LAN:CURRent:ADDRess?^[1]

Syntax

```
SYSTem:COMMunicate:LAN:CURRent:ADDRess?
```

Description

This query returns the current setting of the IP address in use by the U2040 X-Series.

NOTE

If DHCP or AutoIP is enabled and successful, then one of these IP address modes assigns the IP address, otherwise it is the static IP address.

Example

```
SYST:COMM:LAN:CURR:ADDR?
```

Queries the current setting of the IP address.

[1] Applicable for U2049XA only.

SYSTem:COMMunicate:LAN:CURRent:DGATeway?^[1]

Syntax

```
SYSTem:COMMunicate:LAN:CURRent:DGATeway?
```

Description

This query returns the current setting of the LAN IP router/gateway address in use by the U2040 X-Series.

NOTE

If DHCP or AutoIP are enabled and successful, then one of these IP address modes assigns the LAN IP router/gateway address, otherwise it is the static LAN IP router/gateway address.

Example

```
SYST:COMM:LAN:CURR:DGAT?
```

Queries the current setting of the LAN IP router/gateway address.

[1] Applicable for U2049XA only.

SYSTem:COMMunicate:LAN:CURRent:DNAMe?^[1]

Syntax

```
SYSTem:COMMunicate:LAN:CURRent:DNAMe?
```

Description

This query returns the current setting of the LAN domain name in use by the U2040 X-Series.

NOTE

If DHCP or AutoIP is successfully enabled, then one of these IP address modes assigns the LAN domain name, otherwise it is the static LAN domain name.

Example

```
SYST:COMM:LAN:CURR:DNAM?
```

Queries the current setting of the LAN domain name.

[1] Applicable for U2049XA only.

SYSTem:COMMunicate:LAN:CURRent:SMASk?^[1]

Syntax

```
SYSTem:COMMunicate:LAN:CURRent:SMASk?
```

Description

This query returns the current setting of the LAN subnet mask in use by the U2040 X-Series.

NOTE

If DHCP or AutoIP is successfully enabled, then one of these IP address modes assigns the LAN subnet mask, otherwise it is the static LAN subnet mask.

Example

```
SYST:COMM:LAN:CURR:SMAS?
```

Queries the current setting of the LAN subnet mask.

[1] Applicable for U2049XA only.

SYSTem:COMMunicate:LAN:KEEPAlive^[1]

Syntax

```
SYSTem:COMMunicate:LAN:KEEPAlive <numeric_value>
```

```
SYSTem:COMMunicate:LAN:KEEPAlive?
```

Description

This command sets the LAN keepalive timeout which specifies a number of seconds to keep a LAN socket active. If there has been no activity on the connection after the specified timeout, the instrument will send keepalive probes to the client to determine if it is still available. After the specified timeout, the connection will be marked as "down" or "dropped".

NOTE

- If you specify a timeout value, it is recommended that you use the largest value that still meets the application's need for unreachable client detection. Smaller timeout values will generate more keepalive probes thus using more of the available network bandwidth.
- The timeout value is stored in non-volatile memory, and does not change when power has been off, after a Factory Reset (*RST command), or after an Instrument Preset (SYSTem:PRESet command).
- If you specify a value of "0", no timeout is set; the instrument will wait indefinitely and will not send any keepalive probes to the client.
- The command can be used with SYSTem:COMMunicate:LAN:REStart to renew the LAN setting.

Parameter

Item	Range of values	Description/Default value
<numeric_value>	0 s to 7200 s	Desired timeout in seconds between 0 seconds (no timeout) to 7200 seconds (2 hours)

[1] Applicable for U2049XA only.

Example

```
SYST:COMM:LAN:KEEP 1800
```

This command sets the timeout to 1800 seconds (30 minutes).

```
SYST:COMM:LAN:KEEP?
```

The query returns the timeout currently being used.

SYSTem:COMMunicate:TCPIP:CONTRol?[1]

Syntax

```
SYSTem:COMMunicate:TCPIP:CONTRol?
```

Description

This query returns the socket number of control from the SCPI/SOCKET connection.

Example

```
SYST:COMM:TCP:CONT?           Queries the socket number.
```

Error message

If the wrong connection type is used, error -310, "System error" occurs.

[1] Applicable for U2049XA only.

SYSTem:ERRor?

Syntax

```
SYSTem:ERRor?
```

Description

This query returns error numbers and messages from the U2040 X-Series error queue. When an error is generated by the U2040 X-Series, it stores an error number and its corresponding message in the error queue. One error is removed from the error queue each time this query is executed. The errors are cleared in the order of first-in first-out, that is, the oldest errors are cleared first. To clear all the errors from the error queue, execute the *CLS command. When the error queue is empty, subsequent SYSTem:ERRor? queries return a +0, “No error” message. The error queue has a maximum capacity of 30 errors.

Example

SYST:ERR?	Queries the oldest error message stored in the U2040 X-Series error queue.
-----------	--

Reset condition

On reset, the error queue is unaffected.

Error message

If the error queue overflows, the last error is replaced with -350, “Queue overflow”. No additional errors are accepted by the queue until space becomes available.

Error message list

-56	System error. Invalid sensor model number. An invalid sensor model number is found in the U2040 X-Series EEPROM.
-101	Invalid character An invalid character was found in the command string. You may have inserted a character such as #, \$, or % in the command header or within a parameter. For example, LIM:LOW 0#.
-102	Syntax error Invalid syntax was found in the command string. For example, AVER:COUN: AUTO 1.

-103	<p>Invalid separator</p> <p>An invalid separator was found in the command string. You may have used a comma instead of a colon, semicolon, or blank space; or you may have used a blank space instead of a comma.</p> <p>For example, <code>OUTP:TRIG,1</code>.</p>
-105	<p>GET not allowed</p> <p>A Group Execute Trigger (GET) is not allowed within a command string.</p>
-108	<p>Parameter not allowed</p> <p>More parameters were received than expected for the command. You may have entered an extra parameter, or added a parameter to a command that does not accept a parameter.</p> <p>For example, <code>CAL 10</code>.</p>
-109	<p>Missing parameter</p> <p>Fewer parameters were received than expected for the command. You may have omitted one or more parameters that are required for this command.</p> <p>For example, <code>AVER:COUN</code>.</p>
-112	<p>Program mnemonic too long</p> <p>A command header was received which contained more than the maximum 12 characters allowed.</p> <p>For example, <code>SENSeAVERageCOUNt 8</code>.</p>
-113	<p>Undefined header</p> <p>A command was received that is not valid for the U2040 X-Series. You may have misspelled the command, it may not be a valid command, or you may have the wrong interface selected. If you are using the short form of the command, remember that it may contain up to four letters.</p> <p>For example, <code>TRIG:SOUR0 IMM</code>.</p>
-121	<p>Invalid character in number</p> <p>An invalid character was found in the number specified for a parameter value.</p> <p>For example, <code>SENS:AVER:COUN 128#H</code>.</p>
-123	<p>Exponent too large</p> <p>A numeric parameter was found whose exponent was larger than 32000.</p> <p>For example, <code>SENS:AVER:COUN 1E34000</code>.</p>
-124	<p>Too many digits</p> <p>A numeric parameter was found whose mantissa contained more than 255 digits, excluding leading zeros.</p>
-128	<p>Numeric data not allowed</p> <p>A numeric value was received within a command which does not accept a numeric value.</p> <p>For example, <code>MEM:CLE 24</code>.</p>
-131	<p>Invalid suffix</p> <p>A suffix was incorrectly specified for a numeric parameter. You may have misspelled the suffix.</p> <p>For example, <code>SENS:FREQ 200KZ</code>.</p>
-134	<p>Suffix too long</p> <p>A suffix used contained more than 14 characters.</p> <p>For example, <code>SENS:FREQ 2MHZZZZZZZZZZZZ</code>.</p>
-138	<p>Suffix not allowed</p> <p>A suffix was received following a numeric parameter which does not accept a suffix.</p> <p>For example, <code>INIT:CONT 0Hz</code>.</p>
-148	<p>Character data not allowed</p> <p>A discrete parameter was received but a character string or a numeric parameter was expected. Check the list of parameters to verify that you have used a valid parameter type.</p> <p>For example, <code>MEM:CLE CUSTOM_1</code>.</p>

-151	<p>Invalid string data</p> <p>An invalid string was received. Check to see if you have enclosed the character string in single or double quotes.</p> <p>For example, <code>MEM:CLE "CUSTOM_1"</code>.</p>
-158	<p>String data not allowed</p> <p>A character string was received but is not allowed for the command. Check the list of parameters to verify that you have used a valid parameter type.</p> <p>For example, <code>SENS:AVER:COUN:AUTO 'ON'</code>.</p>
-161	<p>Invalid block data</p> <p>A block data element was expected but was invalid for some reason.</p> <p>For example, <code>*DDT #15FET</code>. The 5 in the string indicates that five characters should follow, whereas in this example there are only three.</p>
-211	<p>Trigger ignored</p> <p>Indicates that <code>*TRG</code> or <code>TRIG:IMM</code> was received and recognized by the U2040 X-Series but was ignored because the U2040 X-Series was not in the wait-for-trigger state.</p>
-213	<p>Init ignored</p> <p>Indicates that a request for measurement initiation was ignored as the U2040 X-Series was already initiated.</p> <p>For example,</p> <pre>INIT:CONT ON INIT.</pre>
-214	<p>Trigger deadlock</p> <p><code>TRIG:SOUR</code> was set to <code>HOLD</code> or <code>BUS</code>, and a <code>READ?</code> or <code>MEASURE?</code> was attempted, expecting <code>TRIG:SOUR</code> to be set to <code>IMMEDIATE</code>.</p>
-220	<p>Parameter error; Frequency list must be in ascending order.</p> <p>Indicates that frequencies entered using the <code>MEMORY:TABLE:FREQUENCY</code> command are not in the ascending order.</p>
-221	<p>Settings conflict</p> <p>This message occurs under a variety of conflicting conditions. The following list gives a few examples of where this error may occur:</p> <ul style="list-style-type: none"> If the <code>READ?</code> parameters do not match the current settings. If you are in the fast mode and attempting to switch on for example, averaging or limits. Trying to clear a frequency-dependent offset table when none is selected.
-222	<p>Data out of range</p> <p>A numeric parameter value is outside the valid range for the command.</p> <p>For example, <code>SENS:FREQ 1HZ</code>.</p>
-224	<p>Illegal parameter value</p> <p>A discrete parameter was received which was not a valid choice for the command. You may have used an invalid parameter choice.</p> <p>For example, <code>TRIG:SOUR EX</code>.</p>
-226	<p>Lists not same length</p> <p>This occurs when <code>SENSE:CORRECTION:CSET2:STATE</code> is set to <code>ON</code> and the frequency and offset lists do not correspond in length.</p>
-230	<p>Data corrupt or stale</p> <p>This occur when the trace data return is invalid.</p>
-231	<p>Data questionable; CAL ERROR</p> <p>The U2040 X-Series calibration failed.</p>
-231	<p>Data questionable; Input Overload</p> <p>The power input to the U2040 X-Series exceeds the maximum range.</p>

-231	Data questionable;CALC1 log error This indicates that a difference measurement in the CALCulate1 block has given a negative result when the units of measurement were logarithmic.
-231	Data questionable;CALC2 log error This indicates that a difference measurement in the CALCulate2 block has given a negative result when the units of measurement were logarithmic.
-231	Data questionable;CALC3 log error This indicates that a difference measurement in the CALCulate3 block has given a negative result when the units of measurement were logarithmic.
-231	Data questionable;CALC4 log error This indicates that a difference measurement in the CALCulate4 block has given a negative result when the units of measurement were logarithmic.
-231	Data questionable;ZERO ERROR The U2040 X-Series zeroing failed.
-310	System error;Sensor EEPROM Read Failed - critical data not found or unreadable This indicates a failure with the U2040 X-Series. Refer to the manual for details on returning it for repair.
-310	System error;Sensor EEPROM Read Completed OK but optional data block(s) not found or unreadable This indicates a failure with the U2040 X-Series. Refer to the manual for details on returning it for repair.
-310	System error;Sensor EEPROM Read Failed - unknown EEPROM table format This indicates a failure with the U2040 X-Series. Refer to the manual for details on returning it for repair.
-310	System error;Sensor EEPROM < > data not found or unreadable Where < > refers to the sensor data block covered, for example, Linearity, Temp - Comp (temperature compensation). This indicates a failure with the U2040 X-Series. Refer to the manual for details on returning it for repair.
-310	System error;The sensor could not obtain a LAN configuration using DHCP. The sensor will try to obtain IP address using AutoIP if enabled The U2049XA was configured to use DHCP to obtain the LAN interface configuration. The U2049XA was not able to negotiate with surrounding DHCP servers. Either DHCP servers are not present, or they are not allowing the U2049XA to obtain an IP address. It may be possible the LAN cable is disconnected or is broken. The U2049XA will try to obtain LAN configuration using AutoIP if enabled, or else the U2049XA will try to use the static IP set in the U2049XA.
-310	System error;The sensor could not obtain a LAN configuration using AutoIP. The sensor will try to use the static IP address The U2049XA was not able to obtain the LAN interface configuration using AutoIP. The U2049XA will try to use the static IP set in the U2049XA.
-310	System error;The sensor has detected an IP address conflict The U2049XA encountered a manual or static IP address conflict setting. There is another device using the same IP address in the same network. If this happened, the IP address will be set to "0.0.0.0". It is advisable to perform a LAN reset to restore the default LAN configuration, so that the U2049XA could be connected through DHCP or AutoIP to change the static IP address to a non-conflict IP address.
-321	Out of memory The U2040 X-Series required more memory than was available to run an internal operation.
-330	Self-test Failed; The -330, "Self-test Failed" errors indicate that you have a problem with the U2040 X-Series. Refer to the <i>Service Guide</i> for details of what to do with your faulty U2040 X-Series.
-330	Self-test Failed;RAM SelfTest Failed
-330	Self-test Failed;Flash SelfTest Failed

-330	Self-test Failed;Peak Path SelfTest Failed
-330	Self-test Failed;IPC SelfTest Failed
-330	Self-test Failed;Meas Path SelfTest Failed
-350	Queue overflow The error queue is full and another error has occurred which could not be recorded.
-410	Query INTERRUPTED A command was received which sends data to the output buffer, but the output buffer contained data from a previous command (the previous data is not overwritten). The output buffer is cleared when power has been turned off, or after the *RST (reset) command has been executed.
-420	Query UNTERMINATED The U2040 X-Series was addressed to talk (that is, to send data over the interface) but a command has not been received which sends data to the output buffer. For example you may have executed a CONFIGure command (which does not generate data) and then attempted to read data from the remote interface.
-430	Query DEADLOCKED A command was received which generates too much data to fit in the output buffer and the input buffer is also full. Command execution continues but data is lost.
-440	Query UNTERMINATED after indefinite response The *IDN? command must be the last query command within a command string.

SYSTem:HELP:HEADers?

Syntax

SYSTem:HELP:HEADers?

Description

This query returns a list of all SCPI commands supported by the U2040 X-Series. Data is returned in the IEEE-488.2 arbitrary block program data format as shown in **Figure 19-1** below.

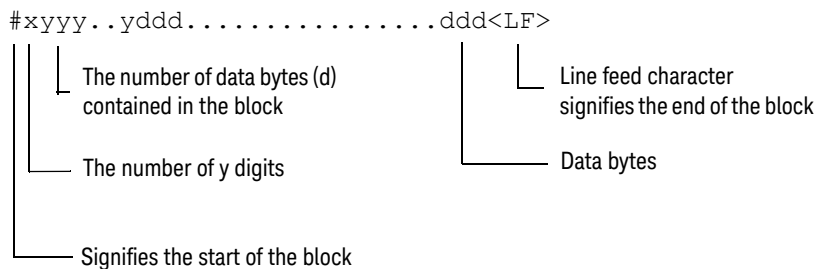

Example: if there are 12435 data bytes, y = 12435 and x = 5

Figure 19-1 IEEE-488.2 arbitrary block program data format

Each point in the trace is represented as an IEEE-754 32-bit floating point number, made up of four bytes in the data block. The MS byte is transmitted first. Each complete block is terminated by a line feed.

Commands are listed in alphabetical order.

Example

SYST:HELP:HEAD? Returns the SCPI commands supported by the U2040 X-Series.

SYSTEM:PRESet

Syntax

```
SYSTEM:PRESet [<character_data>[,<character_data>]]
```

Description

This command presets the U2040 X-Series to values appropriate for measuring the communications format (specified by the first <character_data>) based on the measurement mode (specified by the second <character_data>). The U2040 X-Series is preset to default values if no value or the value `DEFAULT` is supplied.

NOTE

Default settings apply to both `*RST` and `SYSTEM:PRESet DEFAULT` unless stated otherwise.

Parameters

Item	Range of values	Description/Default value
character_data (1st parameter)	DEFault	A communications format which determines the preset values. Refer to “ DEFault ” on page 348 onwards for a general description of some of these formats.
	GSM900	
	EDGE	
	NADC	
	BLUetooth	
	CDMAone	
	WCDMA	
	CDMA2000	
	IDEN	
	MCPa	
	RADar	
	WL802DOT11A	
	WL802DOT11B/G	
	XEVD0	
	XEVDV	
	TDSCdma	
DVB		
HIPERLAN2		
WIMAX		
HSDPA		
DME		
DMEPRT		
LTEFDD		
LTETDD		
LMEMACQ ^[a]		
character_data ^[b] (2nd parameter)	NORMa1 ^[c] AVERAge	Defines the measurement mode: - NORMa1: sets to the normal mode. - AVERAge: sets to the average mode.

[a] Applicable for U2049XA only.

[b] If this parameter is not specified, the command will preset the U2040 X-Series to values appropriate for measuring the communications format based on the current measurement mode defined by SENS : DET : FUNC.

[c] Applicable for U2042XA/U2044XA/U2049XA only.

Examples

```
SYST: PRES DEF
```

Presets the U2040 X-Series to default values. The same default values are set when the parameter is omitted.

```
SYST: PRES GSM900, NORM
```

Presets the U2042XA/U2044XA/U2049XA to GSM900 values for the normal measurement mode.

Preset values

DEFault

Table 19-1 shows the U2040 X-Series presets when <character_data> is set to DEFault or omitted.

Table 19-1 DEFault: U2040 X-Series presets

Command	Setting	Comment
CALC [1] 2 3 4 : FEED [1] 2	"POW:AVER"	Select average measurement type
CALC [1] 2 3 4 : GAIN [: MAGN]	0.000 dB	Calc offset value
CALC [1] 2 3 4 : GAIN : STAT	OFF	Calc offset disabled
CALC [1] 2 3 4 : LIM : CLE : AUTO	ON	Clear limit data at INIT
CALC [1] 2 3 4 : LIM : LOW [: DATA]	-90 dBm	Lower limit
CALC [1] 2 3 4 : LIM : STAT	OFF	Calc limits checking disabled
CALC [1] 2 3 4 : LIM : UP [: DATA]	+90 dBm	
CALC [1] 2 3 4 : MATH [: EXPR]	Sens1	Math expression
CALC [1] 2 3 4 : REL [: MAGN] : AUTO	OFF	Reference value disabled
CALC [1] 2 3 4 : REL : STAT	OFF	Relative offset disabled
FORM [: READ] : BORD	normal	Binary order
FORM [: READ] [: DATA]	ascii	Data format
INIT [1] : CONT	*RST: OFF SYS: PRES ON	U2040 X-Series in idle state U2040 X-Series in wait-for-trigger state
MEM : TABL : SEL	not affected	Active sensor calibration table
OUTP : TRIG : STAT	OFF	Trigger output signal disabled
[SENS [1] :] AVER : COUN	4	Filter length
[SENS [1] :] AVER : COUN : AUTO	ON	Auto-filtering enabled
[SENS [1] :] AVER : SDET	1	Step detection enabled
[SENS [1] :] AVER [: STAT]	ON	Averaging enabled
[SENS [1] :] AVER2 : COUN	4	Video average length
[SENS [1] :] AVER2 [: STAT]	OFF	Video averaging disabled
[SENS [1] :] BAND BWID : VID	OFF	Sensor video bandwidth set to off
[SENS [1] :] CORR : CSET2 [: SEL]	not affected	Selected sensor calibration table
[SENS [1] :] CORR : CSET2 : STAT	not affected	Sensor calibration table disabled
[SENS [1] :] CORR : FDOF GAIN4 [: INP] [: MAGN]	not affected	Return frequency dependent offset
[SENS [1] :] CORR : GAIN2 : STAT	OFF	Channel offset disabled

Table 19-1 DEFault: U2040 X-Series presets (continued)

Command	Setting	Comment
[SENS[1]:CORR:GAIN2[:INP][:MAGN]	0.0 dB	Enter channel offset value
[SENS[1]:]DET:FUNC	AVER	Measurement mode
[SENS[1]:]FREQ[:CW :FIX]	+50.000 MHz	Frequency setting
[SENS[1]:]LIST:STAT	OFF	List mode
[SENS[1]:]LIST:MTYP	AVER	List mode select average measurement type
[SENS[1]:]MRAT	NORM	Measurement speed
[SENS[1]:]SWE[1] 2 3 4:OFFS:TIME	0	Set delay
[SENS[1]:]SWE[1] 2 3 4:TIME	Gate 1: 100 μ s Other gates: 0 s	Set time gated period
[SENS[1]:]TRAC:OFFS:TIME	0	Delay
[SENS[1]:]TRAC:TIME	100 μ s	Duration of trace
TRAC[1]:STAT	OFF	Disable trace capture
TRAC[1]:UNIT	dBm	Trace units
TRIG[1]:DEL:AUTO	ON	Insert settling time delay
TRIG[:SEQ]:DEL	0	Delay between recognition of trigger event and start of a measurement
TRIG[:SEQ]:HOLD	1 μ s	Trigger holdoff
TRIG[:SEQ]:HYST	0 dB	Fall/rise below/above TRIG:LEV
TRIG[:SEQ]:LEV	0 dB	Power level
TRIG[:SEQ]:LEV:AUTO	ON	Enable automatic setting of trigger level
TRIG[:SEQ]:SLOP	POS	Trigger event recognized on rising edge
TRIG[:SEQ[1]]:COUN	1	Trigger events for measurement cycle
TRIG[:SEQ[1]]:DEL:AUTO	ON	Enable settling time delay
TRIG[:SEQ[1]]:SOUR	IMM	Trigger source setup
UNIT[1] 2 3 4:POW	dBm	Power units
UNIT[1] 2 3 4:POW:RAT	dB	Ratio units

GSM900

The GSM900 setup returns the average power measurement in one GSM time slot, when queried by CALC1.

A GSM900 measurement is started by detecting the rising edge of a GSM RF burst – for example the burst emitted by a GSM mobile – using the internal RF level trigger. The trigger level is set to –15 dBm. Time gating is used to measure the average power in the useful part of a GSM burst.

Table 19-2 GSM900: U2040 X-Series presets

Command	Setting	Comment
<i>Frequency</i>		
[SENS[1]:]FREQ[:CW]:FIX]	+900.000 MHz	Frequency setting
AVERage measurement mode		
<i>Trigger setup</i>		
TRIG[:SEQ]:DEL	0	Delay between recognition of trigger event and start of a measurement
<i>Aperture duration</i>		
[SENS[1]:]SWE:APER	4.615 ms	Aperture duration
NORMal measurement mode		
<i>Sensor video bandwidth setup</i>		
[SENS[1]:]BAND BWID:VID	LOW	Sensor video bandwidth
<i>Gate setup</i>		
[SENS[1]:]SWE[1] 2 3 4:OFF:TIME	Gate 1: 20 μ s Gates 2 – 4: 0	Delay between trigger point and time gated period
[SENS[1]:]SWE[1] 2 3 4:TIME	Gate 1: 520 μ s Gates 2 – 4: 0	Length of time gated period for time gated measurements
<i>Trigger setup</i>		
TRIG[:SEQ[1]]:SOUR	INT1	Trigger source setup and acquisition mode continuous triggering
INIT:CONT	ON	
TRIG[:SEQ]:LEV:AUTO	OFF	Disable automatic setting of the trigger level
TRIG[:SEQ]:LEV	–15 dBm	Power level
TRIG[:SEQ]:SLOP	POS	Trigger event recognized on the rising edge of a signal
TRIG[:SEQ]:DEL	20 μ s	Delay between recognition of trigger event and start of a measurement
TRIG[:SEQ]:HOLD	428 μ s	Trigger holdoff
TRIG[:SEQ]:HYST	0	How far a signal must fall/rise before a rising or falling edge can be detected

Table 19-2 GSM900: U2040 X-Series presets (continued)

Command	Setting	Comment
TRIG[:SEQ]:QUAL:TIME	20 μ s	Trigger qualification time
<i>Averaging</i>		
[SENS[1]:]AVER:COUN:AUTO	ON	Auto-averaging enabled
<i>Video averaging</i>		
[SENS[1]:]AVER2	OFF	Video averaging disabled
<i>Step detection</i>		
[SENS[1]:]AVER:SDET	1	Step detection enabled
<i>Trace setup</i>		
[SENS[1]:]TRAC:OFFS:TIME <numeric_value>	-40 μ s	Delay between delayed trigger point and the start of the trace
[SENS[1]:]TRAC:TIME <numeric_value>	700 μ s	Length of the trace
<i>Reference level setup</i>		
TRAC[1]:DEF:TRAN:REF	10%, 90%	Transition reference levels
TRAC[1]:DEF:DUR:REF	50%	Pulse duration reference level

Table 19-3 GSM900: U2040 X-Series presets for calc setup

Command	Setting
AVERage measurement mode	
<i>Calc setup</i>	
Calc1-4 feed	Gate 1
Calc1-4 measurement	Average
NORMal measurement mode	
<i>Calc setup</i>	
Calc1 feed	Gate 1
Calc1 measurement	Average
Calc2 feed	Gate 1
Calc2 measurement	Average
Calc3 feed	Gate 1
Calc3 measurement	Average
Calc4 feed	Gate 1
Calc4 measurement	Average

EDGE

EDGE (Enhanced Data for Global Evolution or Enhanced Data for GSM Evolution) is an enhancement of the GSM standard. Whereas the GSM modulation scheme is GMSK which has constant amplitude, the EDGE modulation scheme is 8PSK which has variable amplitude.

The EDGE setup returns the following measurement results:

- Average power measurement in an EDGE burst, when queried by CALC1.
- Peak-to-average power measurement in an EDGE burst, when queried by CALC4.

An EDGE measurement is started by detecting the rising edge of the EDGE RF burst – for example the burst emitted by a mobile – using the internal RF level trigger. The internal level trigger is set to –15 dBm.

Trigger level hysteresis is used to prevent the U2040 X-Series re-triggering on the varying power levels within the EDGE burst. Time gating is used to measure the average power and peak-to-average ratio in the useful part of the RF burst.

Table 19-4 EDGE: U2040 X-Series presets

Command	Setting	Comment
<i>Frequency</i>		
[SENS[1]:]FREQ[:CW :FIX]	+900.000 MHz	Frequency setting
AVERAGE measurement mode		
<i>Trigger setup</i>		
TRIG[:SEQ]:DEL	0	Delay between recognition of trigger event and start of a measurement
<i>Aperture duration</i>		
[SENS[1]:]SWE:APER	4.615 ms	Aperture duration
NORMAL measurement mode		
<i>Sensor video bandwidth setup</i>		
[SENS[1]:]BAND BWID:VID	LOW	Sensor video bandwidth
<i>Gate setup</i>		
[SENS[1]:]SWE[1] 2 3 4:OFFS:TIME	Gate 1: 20 μ s Gates 2 – 4: 0	Delay between trigger point and time gated period
[SENS[1]:]SWE[1] 2 3 4:TIME	Gate 1: 520 μ s Gates 2 – 4: 0	Length of time gated period for time gated measurements
<i>Trigger setup</i>		
TRIG[:SEQ[1]]:SOUR	INT1	Trigger source setup and acquisition mode continuous triggering
INIT:CONT	ON	
TRIG[:SEQ]:LEV:AUTO	OFF	Disable automatic setting of the trigger level

Table 19-4 EDGE: U2040 X-Series presets (continued)

Command	Setting	Comment
TRIG[:SEQ]:LEV	-15 dBm	Power level
TRIG[:SEQ]:SLOP	POS	Trigger event recognized on the rising edge of a signal
TRIG[:SEQ]:DEL	0 s	Delay between recognition of trigger event and start of a measurement
TRIG[:SEQ]:HOLD	428 μs	Trigger holdoff
TRIG[:SEQ]:HYST	3 dB	Hysteresis
TRIG[:SEQ]:QUAL:TIME	20.25 μs	Trigger qualification time
<i>Averaging</i>		
[SENS[1]:]AVER[:STATe]	ON	Averaging on
[SENS[1]:]AVER:COUN	64	Averaging set to 64
<i>Video averaging</i>		
[SENS[1]:]AVER2	OFF	Video averaging disabled
<i>Step detection</i>		
[SENS[1]:]AVER:SDET	1	Step detection enabled
<i>Trace setup</i>		
[SENS[1]:]TRAC:OFFS:TIME <numeric_value>	-40 μs	Delay between delayed trigger point and the start of the trace
[SENS[1]:]TRAC:TIME <numeric_value>	700 μs	Length of the trace
<i>Reference level setup</i>		
TRAC[1]:DEF:TRAN:REF	10%, 90%	Transition reference levels
TRAC[1]:DEF:DUR:REF	50%	Pulse duration reference level

Table 19-5 EDGE: U2040 X-Series presets for calc setup

Command	Setting
AVERage measurement mode	
<i>Calc setup</i>	
Calc1-4 feed	Gate 1
Calc1-4 measurement	Average
NORMal measurement mode	
<i>Calc setup</i>	
Calc1 feed	Gate 1
Calc1 measurement	Average

Table 19-5 EDGE: U2040 X-Series presets for calc setup (continued)

Command	Setting
Calc2 feed	Gate 1
Calc2 measurement	Average
Calc3 feed	Gate 1
Calc3 measurement	Average
Calc4 feed	Gate 1
Calc4 measurement	Peak to average

NADC

The NADC setup returns the average power measurement of both active time slots in NADC or IS-136 "full rate" transmission, when using both CALC1 and CALC3 respectively.

This assumes that there are two time slots to be measured in each frame, as for example with time slots 0 in the following diagram:

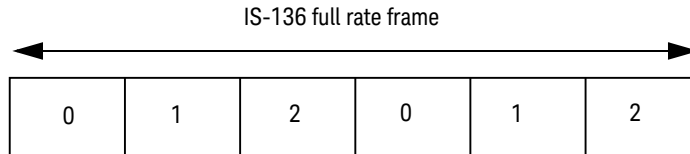

The measurement is started by detecting the RF burst – for example, the burst emitted by a mobile – using the internal RF level trigger. The internal level trigger is set to -15 dBm. Time gating is used to measure the average power in two active time slots which are separated by two inactive time slots.

Table 19-6 NADC: U2040 X-Series presets

Command	Setting	Comment
<i>Frequency</i>		
[SENS[1]:]FREQ[:CW :FIX]	+800.000 MHz	Frequency setting
AVERage measurement mode		
<i>Trigger setup</i>		
TRIG[:SEQ]:DEL	0	Delay between recognition of trigger event and start of a measurement
<i>Aperture duration</i>		
[SENS[1]:]SWE:APER	40 ms	Aperture duration
NORMAL measurement mode		
<i>Sensor video bandwidth setup</i>		
[SENS[1]:]BAND BWID:VID	OFF	Sensor video bandwidth
<i>Gate setup</i>		
[SENS[1]:]SWE[1] 2 3 4:OFF:TIME	Gate 1: 124 μs Gate 2: 20.1 ms Gates 3 – 4: 0	Delay between trigger point and time gated period
[SENS[1]:]SWE[1] 2 3 4:TIME	Gate 1: 6.46 ms Gate 2: 6.46 ms Gates 3 – 4: 0	Length of time gated period for time gated measurements
<i>Trigger setup</i>		
TRIG[:SEQ[1]]:SOUR	INT1	Trigger source setup and acquisition mode continuous triggering
INIT:CONT	ON	

Table 19-6 NADC: U2040 X-Series presets (continued)

Command	Setting	Comment
TRIG[:SEQ]:LEV:AUTO	OFF	Disable automatic setting of the trigger level
TRIG[:SEQ]:LEV	-15 dBm	Power level
TRIG[:SEQ]:SLOP	POS	Trigger event recognized on the rising edge of a signal
TRIG[:SEQ]:DEL	0 s	Delay between recognition of trigger event and start of a measurement
TRIG[:SEQ]:HOLD	30 ms	Trigger holdoff
TRIG[:SEQ]:HYST	0	Hysteresis
TRIG[:SEQ]:QUAL:TIME	100 ns	Trigger qualification time
<i>Averaging</i>		
{SENS[1]:}AVER:COUN:AUTO	ON	Auto-averaging enabled
<i>Video averaging</i>		
{SENS[1]:}AVER2	OFF	Video averaging disabled
<i>Step detection</i>		
{SENS[1]:}AVER:SDET	1	Step detection enabled
<i>Trace setup</i>		
{SENS[1]:}TRAC:OFFS:TIME <numeric_value>	-0.2 ms	Delay between delayed trigger point and the start of the trace
{SENS[1]:}TRAC:TIME <numeric_value>	28 ms	Length of the trace
<i>Reference level setup</i>		
TRAC[1]:DEF:TRAN:REF	10%, 90%	Transition reference levels
TRAC[1]:DEF:DUR:REF	50%	Pulse duration reference level

Table 19-7 NADC: U2040 X-Series presets for calc setup

Command	Setting
AVERage measurement mode	
<i>Calc setup</i>	
Calc1-4 feed	Gate 1
Calc1-4 measurement	Average
NORMal measurement mode	
<i>Calc setup</i>	
Calc1 feed	Gate 1
Calc1 measurement	Average

Table 19-7 NADC: U2040 X-Series presets for calc setup (continued)

Command	Setting
Calc2 feed	Gate 1
Calc2 measurement	Average
Calc3 feed	Gate 1
Calc3 measurement	Average
Calc4 feed	Gate 2
Calc4 measurement	Average

BLUetooth

The BLUetooth setup returns the following measurement results:

- Average power in a Bluetooth DH1 data burst, when queried by CALC1.
- Peak power in the same burst, when queried by CALC4.

The measurement is started by detecting the Bluetooth RF burst using the internal RF level trigger. The internal trigger is set to -15 dBm. Time gating is used to measure the peak and average power in a single Bluetooth DHI data burst which lasts for $366 \mu\text{s}$. The DHI burst does not occupy a full Bluetooth time slot, which lasts for $625 \mu\text{s}$.

Table 19-8 BLUetooth: U2040 X-Series presets

Command	Setting	Comment
<i>Frequency</i>		
[SENS[1]:]FREQ[:CW :FIX]	+2400.000 MHz	Frequency setting
AVERage measurement mode		
<i>Trigger setup</i>		
TRIG[:SEQ]:DEL	0	Delay between recognition of trigger event and start of a measurement
<i>Aperture duration</i>		
[SENS[1]:]SWE:APER	1.25 ms	Aperture duration
NORMal measurement mode		
<i>Sensor video bandwidth setup</i>		
[SENS[1]:]BAND BWID:VID	OFF	Sensor video bandwidth
<i>Gate setup</i>		
[SENS[1]:]SWE[1] 2 3 4:OFF:TIME	Gate 1: $0.2 \mu\text{s}$ Gates 2 – 4: 0	Delay between trigger point and time gated period
[SENS[1]:]SWE[1] 2 3 4:TIME	Gate 1: $366 \mu\text{s}$ Gates 2 – 4: 0	Length of time gated period for time gated measurements
<i>Trigger setup</i>		
TRIG[:SEQ[1]]:SOUR	INT1	Trigger source setup and acquisition mode continuous triggering
INIT:CONT	ON	
TRIG[:SEQ]:LEV:AUTO	OFF	Disable automatic setting of the trigger level
TRIG[:SEQ]:LEV	-15 dBm	Power level
TRIG[:SEQ]:SLOP	POS	Trigger event recognized on the rising edge of a signal
TRIG[:SEQ]:DEL	0 s	Delay between recognition of trigger event and start of a measurement
TRIG[:SEQ]:HOLD	$650 \mu\text{s}$	Trigger holdoff

Table 19-8 BLUetooth: U2040 X-Series presets (continued)

Command	Setting	Comment
TRIG[:SEQ]:HYST	0	Hysteresis
TRIG[:SEQ]:QUAL:TIME	100 ns	Trigger qualification time
<i>Averaging</i>		
[SENS[1]:]AVER:COUN:AUTO	ON	Auto-averaging enabled
<i>Video averaging</i>		
[SENS[1]:]AVER2	OFF	Video averaging disabled
<i>Step detection</i>		
[SENS[1]:]AVER:SDET	1	Step detection enabled
<i>Trace setup</i>		
[SENS[1]:]TRAC:OFFS:TIME <numeric_value>	-50 μs	Delay between delayed trigger point and the start of the trace
[SENS[1]:]TRAC:TIME <numeric_value>	3.8 ms	Length of the trace
<i>Reference level setup</i>		
TRAC[1]:DEF:TRAN:REF	10%, 90%	Transition reference levels
TRAC[1]:DEF:DUR:REF	50%	Pulse duration reference level

Table 19-9 BLUetooth: U2040 X-Series presets for calc setup

Command	Setting
AVERage measurement mode	
<i>Calc setup</i>	
Calc1-4 feed	Gate 1
Calc1-4 measurement	Average
NORMAl measurement mode	
<i>Calc setup</i>	
Calc1 feed	Gate 1
Calc1 measurement	Average
Calc2 feed	Gate 1
Calc2 measurement	Average
Calc3 feed	Gate 1
Calc3 measurement	Average
Calc4 feed	Gate 1
Calc4 measurement	Peak

CDMAone

The CDMAone setup returns the following measurement results:

- Average power in an IS-95 CDMAone signal (bandwidth < 1.5 MHz), when queried by CALC1.
- Peak power over a defined, statistically valid number of samples, when queried by CALC2.
- Peak-to-average ratio of the signal, when queried by CALC4.

The measurement is a continuously gated measurement on a CDMAone signal. Its aim is to measure the peak and average power corresponding to a <0.01% probability that there are no peaks above the returned peak reading. Time gating is therefore set to 10 ms. Triggering is set to occur continuously internally to the U2040 X-Series. The internal trigger is set to AutoLevel. A reading over the 10 ms period is returned and the reading is then re-initiated for the next 10 ms period. In this way, the reading will refresh to track any signal or DUT changes.

Table 19-10 CDMAone: U2040 X-Series presets

Command	Setting	Comment
<i>Frequency</i>		
[SENS[1]:]FREQ[:CW :FIX]	+850.000 MHz	Frequency setting
AVERage measurement mode		
<i>Trigger setup</i>		
TRIG[:SEQ]:DEL	0	Delay between recognition of trigger event and start of a measurement
<i>Aperture duration</i>		
[SENS[1]:]SWE:APER	10 ms	Aperture duration
NORMal measurement mode		
<i>Sensor video bandwidth setup</i>		
[SENS[1]:]BAND BWID:VID	OFF	Sensor video bandwidth
<i>Gate setup</i>		
[SENS[1]:]SWE[1] 2 3 4:OFF:TIME	Gate 1: 0 s Gates 2 – 4: 0	Delay between trigger point and time gated period
[SENS[1]:]SWE[1] 2 3 4:TIME	Gate 1: 10 ms Gates 2 – 4: 0	Length of time gated period for time gated measurements
<i>Trigger setup</i>		
TRIG[:SEQ[1]]:SOUR	INT1	Trigger source setup and acquisition mode continuous triggering
INIT:CONT	ON	
TRIG[:SEQ]:LEV:AUTO	ON	Enable automatic setting of the trigger level

Table 19-10 CDMAone: U2040 X-Series presets

Command	Setting	Comment
TRIG[:SEQ]:LEV	AUTO	Automatic power level
TRIG[:SEQ]:SLOP	POS	Trigger event recognized on the rising edge of a signal
TRIG[:SEQ]:DEL	0 s	Delay between recognition of trigger event and start of a measurement
TRIG[:SEQ]:HOLD	1 μ s	Trigger holdoff
TRIG[:SEQ]:HYST	0	Hysteresis
TRIG[:SEQ]:QUAL:TIME	100 ns	Trigger qualification time
<i>Averaging</i>		
[SENS[1]:]AVER:COUN:AUTO	ON	Auto-averaging enabled
<i>Video averaging</i>		
[SENS[1]:]AVER2	OFF	Video averaging disabled
<i>Step detection</i>		
[SENS[1]:]AVER:SDET	0	Step detection disabled
<i>Trace setup</i>		
[SENS[1]:]TRAC:OFFS:TIME <numeric_value>	0	Delay between delayed trigger point and the start of the trace
[SENS[1]:]TRAC:TIME <numeric_value>	100 μ s	Length of the trace
<i>Reference level setup</i>		
TRAC[1]:DEF:TRAN:REF	10%, 90%	Transition reference levels
TRAC[1]:DEF:DUR:REF	50%	Pulse duration reference level

Table 19-11 CDMAone: U2040 X-Series presets for calc setup

Command	Setting
AVERage measurement mode	
<i>Calc setup</i>	
Calc1-4 feed	Gate 1
Calc1-4 measurement	Average
NORMal measurement mode	
<i>Calc setup</i>	
Calc1 feed	Gate 1
Calc1 measurement	Average
Calc2 feed	Gate 1

Table 19-11 CDMAone: U2040 X-Series presets for calc setup (continued)

Command	Setting
Calc2 measurement	Peak
Calc3 feed 1	Gate 1
Calc3 measurement	Average
Calc3 feed 2	Gate 1
Calc3 measurement	Peak
Calc4 feed	Gate 1
Calc4 measurement	Peak to average

W-CDMA

The W-CDMA setup returns the following measurement results:

- Average power in a W-CDMA signal (bandwidth ≤5 MHz), when queried by CALC1.
- Peak power over a defined, statistically valid number of samples, when queried by CALC2.
- Peak-to-average ratio of the signal, when queried by CALC4.

The measurement is a continuously gated measurement on a 3 GPP W-CDMA signal. Its aim is to measure the peak and average power corresponding to a <0.01% probability that there are no peaks above the returned peak reading. Time gating is set to 10 ms. Triggering is set to occur continuously internally to the U2040 X-Series. The internal trigger is set to AutoLevel. A reading over the 10 ms period is returned then re-initiated for the next 10 ms period. In this way, the reading will refresh to track any signal or DUT changes.

Table 19-12 W-CDMA: U2040 X-Series presets

Command	Setting	Comment
<i>Frequency</i>		
[SENS [1] :] FREQ [: CW : FIX]	+1900.000 MHz	Frequency setting
AVERage measurement mode		
<i>Trigger setup</i>		
TRIG [: SEQ] : DEL	0	Delay between recognition of trigger event and start of a measurement
<i>Aperture duration</i>		
[SENS [1] :] SWE : APER	10 ms	Aperture duration
NORMal measurement mode		
<i>Sensor video bandwidth setup</i>		
[SENS [1] :] BAND BWID : VID	OFF	Sensor video bandwidth
<i>Gate setup</i>		
[SENS [1] :] SWE [1] 2 3 4 : OFF : TIME	Gate 1: 0 s Gates 2 - 4: 0	Delay between trigger point and time gated period
[SENS [1] :] SWE [1] 2 3 4 : TIME	Gate 1: 10 ms Gates 2 - 4: 0	Length of time gated period for time gated measurements
<i>Trigger setup</i>		
TRIG [: SEQ [1]] : SOUR	INT1	Trigger source setup and acquisition mode continuous triggering
INIT : CONT	ON	
TRIG [: SEQ] : LEV : AUTO	ON	Enable automatic setting of the trigger level
TRIG [: SEQ] : LEV	AUTO	Automatic power level

Table 19-12 W-CDMA: U2040 X-Series presets (continued)

Command	Setting	Comment
TRIG[:SEQ]:SLOP	POS	Trigger event recognized on the rising edge of a signal
TRIG[:SEQ]:DEL	0 s	Delay between recognition of trigger event and start of a measurement
TRIG[:SEQ]:HOLD	1 μ s	Trigger holdoff
TRIG[:SEQ]:HYST	0	Hysteresis
TRIG[:SEQ]:QUAL:TIME	100 ns	Trigger qualification time
<i>Averaging</i>		
[SENS[1]:]AVER:COUN:AUTO	ON	Auto-averaging enabled
<i>Video averaging</i>		
[SENS[1]:]AVER2	OFF	Video averaging disabled
<i>Step detection</i>		
[SENS[1]:]AVER:SDET	0	Step detection disabled
<i>Trace setup</i>		
[SENS[1]:]TRAC:OFFS:TIME <numeric_value>	0	Delay between delayed trigger point and the start of the trace
[SENS[1]:]TRAC:TIME <numeric_value>	100 μ s	Length of the trace
<i>Reference level setup</i>		
TRAC[1]:DEF:TRAN:REF	10%, 90%	Transition reference levels
TRAC[1]:DEF:DUR:REF	50%	Pulse duration reference level

Table 19-13 W-CDMA: U2040 X-Series presets for calc setup

Command	Setting
AVERage measurement mode	
<i>Calc setup</i>	
Calc1-4 feed	Gate 1
Calc1-4 measurement	Average
NORMAl measurement mode	
<i>Calc setup</i>	
Calc1 feed	Gate 1
Calc1 measurement	Average
Calc2 feed	Gate 1
Calc2 measurement	Peak

Table 19-13 W-CDMA: U2040 X-Series presets for calc setup (continued)

Command	Setting
Calc3 feed 1	Gate 1
Calc3 measurement	Average
Calc3 feed 2	Gate 1
Calc3 measurement	Peak
Calc4 feed	Gate 1
Calc4 measurement	Peak to average

CDMA2000

The CDMA2000 setup returns the following measurement results:

- Average power in a CDMA2000 signal (bandwidth ≤ 5 MHz), when queried by CALC1.
- Peak power over a defined, statistically valid number of samples, when queried by CALC2.
- Peak-to-average ratio of the signal, when queried by CALC4.

The measurement is a continuously gated measurement on a 3 GPP CDMA2000 signal. Its aim is to measure the peak and average power corresponding to a <0.01% probability that there are no peaks above the returned peak reading. Time gating is set to 10 ms. Triggering is set to occur continuously internally to the U2040 X-Series. The internal trigger is set to AutoLevel. A reading over the 10 ms period is returned, then the reading is re-initiated for the next 10 ms period. In this way, the reading will refresh to track any signal or DUT changes.

Table 19-14 CDMA2000: U2040 X-Series presets

Command	Setting	Comment
<i>Frequency</i>		
[SENS[1]:]FREQ[:CW :FIX]	+1900.000 MHz	Frequency setting
AVERage measurement mode		
<i>Trigger setup</i>		
TRIG[:SEQ]:DEL	0	Delay between recognition of trigger event and start of a measurement
<i>Aperture duration</i>		
[SENS[1]:]SWE:APER	10 ms	Aperture duration
NORMal measurement mode		
<i>Sensor video bandwidth setup</i>		
[SENS[1]:]BAND BWID:VID	OFF	Sensor video bandwidth
<i>Gate setup</i>		
[SENS[1]:]SWE[1] 2 3 4:OFF:TIME	Gate 1: 0 s Gates 2 – 4: 0	Delay between trigger point and time gated period
[SENS[1]:]SWE[1] 2 3 4:TIME	Gate 1: 10 ms Gates 2 – 4: 0	Length of time gated period for time gated measurements
<i>Trigger setup</i>		
TRIG[:SEQ[1]]:SOUR	INT1	Trigger source setup and acquisition mode continuous triggering
INIT:CONT	ON	
TRIG[:SEQ]:LEV:AUTO	ON	Enable automatic setting of the trigger level
TRIG[:SEQ]:LEV	AUTO	Automatic power level

Table 19-14 CDMA2000: U2040 X-Series presets (continued)

Command	Setting	Comment
TRIG[:SEQ]:SLOP	POS	Trigger event recognized on the rising edge of a signal
TRIG[:SEQ]:DEL	0 s	Delay between recognition of trigger event and start of a measurement
TRIG[:SEQ]:HOLD	1 μs	Trigger holdoff
TRIG[:SEQ]:HYST	0	Hysteresis
TRIG[:SEQ]:QUAL:TIME	100 ns	Trigger qualification time
<i>Averaging</i>		
[SENS[1]:]AVER:COUN:AUTO	ON	Auto-averaging enabled
<i>Video averaging</i>		
[SENS[1]:]AVER2	OFF	Video averaging disabled
<i>Step detection</i>		
[SENS[1]:]AVER:SDET	0	Step detection disabled
<i>Trace setup</i>		
[SENS[1]:]TRAC:OFFS:TIME <numeric_value>	0	Delay between delayed trigger point and the start of the trace
[SENS[1]:]TRAC:TIME <numeric_value>	100 μs	Length of the trace
<i>Reference level setup</i>		
TRAC[1]:DEF:TRAN:REF	10%, 90%	Transition reference levels
TRAC[1]:DEF:DUR:REF	50%	Pulse duration reference level

Table 19-15 CDMA2000: U2040 X-Series presets for calc setup

Command	Setting
AVERage measurement mode	
<i>Calc setup</i>	
Calc1-4 feed	Gate 1
Calc1-4 measurement	Average
NORMal measurement mode	
<i>Calc setup</i>	
Calc1 feed	Gate 1
Calc1 measurement	Average
Calc2 feed	Gate 1
Calc2 measurement	Peak

Table 19-15 CDMA2000: U2040 X-Series presets for calc setup (continued)

Command	Setting
Calc3 feed 1	Gate 1
Calc3 measurement	Average
Calc3 feed 2	Gate 1
Calc3 measurement	Peak
Calc4 feed	Gate 1
Calc4 measurement	Peak to average

iDEN

The iDEN setup returns the following measurement results:

- Average power in one iDEN training and data pulse, from CALC1.
- Peak power in one iDEN training and data pulse, from CALC2.
- Peak-to-average ratio of the signal in one iDEN training and data pulse, from CALC4.

The measurement is started by detecting the iDEN training burst – for example, the burst emitted by a mobile – using the internal RF level trigger.

Time gating is used to measure the average power in the following 15 ms (data pulse). Gate 1 is used to measure this data pulse.

Table 19-16 iDEN: U2040 X-Series presets

Command	Setting	Comment
<i>Frequency</i>		
[SENS [1] :] FREQ [: CW : FIX]	+800.000 MHz	Frequency setting
AVERage measurement mode		
<i>Trigger setup</i>		
TRIG [: SEQ] : DEL	0	Delay between recognition of trigger event and start of a measurement
<i>Aperture duration</i>		
[SENS [1] :] SWE : APER	90 ms	Aperture duration
NORMAL measurement mode		
<i>Sensor video bandwidth setup</i>		
[SENS [1] :] BAND BWID : VID	OFF	Sensor video bandwidth
<i>Gate setup</i>		
[SENS [1] :] SWE [1] 2 3 4 : OFF : TIME	Gate 1: 0 s Gates 2 – 4: 0	Delay between trigger point and time gated period.
[SENS [1] :] SWE [1] 2 3 4 : TIME	Gate 1: 15 ms Gate 2: 90 ms Gate 3: 160 μ s Gate 4: 0	Length of time gated period for time gated measurements.
<i>Trigger setup</i>		
TRIG [: SEQ [1]] : SOUR	INT1	Trigger source setup and acquisition mode continuous triggering
INIT : CONT	ON	
TRIG [: SEQ] : LEV : AUTO	OFF	Disable automatic setting of the trigger level
TRIG [: SEQ] : LEV	-15 dBm	Automatic power level
TRIG [: SEQ] : SLOP	POS	Trigger event recognized on the rising edge of a signal

Table 19-16 iDEN: U2040 X-Series presets (continued)

Command	Setting	Comment
TRIG[:SEQ]:DEL	0 s	Delay between recognition of trigger event and start of a measurement
TRIG[:SEQ]:HOLD	20 ms	Trigger holdoff
TRIG[:SEQ]:HYST	0	Hysteresis
TRIG[:SEQ]:QUAL:TIME	100 ns	Trigger qualification time
<i>Averaging</i>		
[SENS[1]:]AVER[:STATE]	ON	Averaging on
[SENS[1]:]AVER:COUN	64	Averaging set to 64
<i>Video averaging</i>		
[SENS[1]:]AVER2	OFF	Video averaging disabled
<i>Step detection</i>		
[SENS[1]:]AVER:SDET	1	Step detection enabled
<i>Trace setup</i>		
[SENS[1]:]TRAC:OFFS:TIME <numeric_value>	0 s	Delay between delayed trigger point and the start of the trace
[SENS[1]:]TRAC:TIME <numeric_value>	100 ms	Length of the trace
<i>Reference level setup</i>		
TRAC[1]:DEF:TRAN:REF	10%, 90%	Transition reference levels
TRAC[1]:DEF:DUR:REF	50%	Pulse duration reference level

Table 19-17 iDEN: U2040 X-Series presets for calc setup

Command	Setting
AVERage measurement mode	
<i>Calc setup</i>	
Calc1-4 feed	Gate 1
Calc1-4 measurement	Average
NORMal measurement mode	
<i>Calc setup</i>	
Calc1 feed	Gate 1
Calc1 measurement	Average
Calc2 feed	Gate 1
Calc2 measurement	Peak
Calc3 feed 1	Gate 1

Table 19-17 iDEN: U2040 X-Series presets for calc setup (continued)

Command	Setting
Calc3 measurement	Average
Calc3 feed	Gate 1
Calc3 measurement	Peak
Calc4 feed	Gate 1
Calc4 measurement	Peak to average

MCPa

Table 19-18 shows the U2040 X-Series presets when <character_data> is set to MCPa.

Table 19-18 MCPa: U2040 X-Series presets

Command	Setting	Comment
<i>Frequency</i>		
[SENS[1]:]FREQ[:CW :FIX]	+1900.000 MHz	Frequency setting
AVERage measurement mode		
<i>Trigger setup</i>		
TRIG[:SEQ]:DEL	0	Delay between recognition of trigger event and start of a measurement
<i>Aperture duration</i>		
[SENS[1]:]SWE:APER	10 ms	Aperture duration
NORMal measurement mode		
<i>Sensor video bandwidth setup</i>		
[SENS[1]:]BAND BWID:VID	OFF	Sensor video bandwidth
<i>Gate setup</i>		
[SENS[1]:]SWE[1] 2 3 4:OFF:TIME	Gate 1: 0 s Gates 2 – 4: 0	Delay between trigger point and time gated period
[SENS[1]:]SWE[1] 2 3 4:TIME	Gate 1: 10 ms Gates 2 – 4: 0	Length of time gated period for time gated measurements
<i>Trigger setup</i>		
TRIG[:SEQ[1]]:SOUR	INT1	Trigger source setup and acquisition mode continuous triggering
INIT:CONT	ON	
TRIG[:SEQ]:LEV:AUTO	OFF	Disable automatic setting of the trigger level
TRIG[:SEQ]:LEV	-15 dBm	Power level
TRIG[:SEQ]:SLOP	POS	Trigger event recognized on the rising edge of a signal
TRIG[:SEQ]:DEL	0 s	Delay between recognition of trigger event and start of a measurement
TRIG[:SEQ]:HOLD	1 μ s	Trigger holdoff
TRIG[:SEQ]:HYST	1	Hysteresis
TRIG[:SEQ]:QUAL:TIME	100 ns	Trigger qualification time
<i>Averaging</i>		
[SENS[1]:]AVER:COUN:AUTO	ON	Auto-averaging enabled
<i>Video averaging</i>		

Table 19-18 MCPa: U2040 X-Series presets (continued)

Command	Setting	Comment
[SENS [1] :] AVER2	OFF	Video averaging disabled
<i>Step detection</i>		
[SENS [1] :] AVER:SDET	0	Step detection disabled
<i>Trace setup</i>		
[SENS [1] :] TRAC:OFFS:TIME <numeric_value>	0 s	Delay between delayed trigger point and the start of the trace
[SENS [1] :] TRAC:TIME <numeric_value>	100 μ s	Length of the trace
<i>Reference level setup</i>		
TRAC [1] : DEF:TRAN:REF	10%, 90%	Transition reference levels
TRAC [1] : DEF:DUR:REF	50%	Pulse duration reference level

Table 19-19 MCPa: U2040 X-Series presets for calc setup

Command	Setting
AVERage measurement mode	
<i>Calc setup</i>	
Calc1-4 feed	Gate 1
Calc1-4 measurement	Average
NORMal measurement mode	
<i>Calc setup</i>	
Calc1 feed	Gate 1
Calc1 measurement	Average
Calc2 feed	Gate 1
Calc2 measurement	Peak
Calc3 feed 1	Gate 1
Calc3 measurement	Average
Calc3 feed	Gate 1
Calc3 measurement	Peak
Calc4 feed	Gate 1
Calc4 measurement	Peak

RADar

Table 19-20 shows the U2040 X-Series presets when <character_data> is set to RADar.

Table 19-20 RADar: U2040 X-Series presets

Command	Setting	Comment
<i>Frequency</i>		
[SENS[1]:]FREQ[:CW :FIX]	+10 GHz	Frequency setting
AVERage measurement mode		
<i>Trigger setup</i>		
TRIG[:SEQ]:DEL	0	Delay between recognition of trigger event and start of a measurement
<i>Aperture duration</i>		
[SENS[1]:]SWE:APER	20 μ s	Aperture duration
NORMal measurement mode		
<i>Sensor video bandwidth setup</i>		
[SENS[1]:]BAND BWID:VID	OFF	Sensor video bandwidth
<i>Gate setup</i>		
[SENS[1]:]SWE[1] 2 3 4:OFF:TIME	Gate 1: 0 Gate 2: 0 Gate 3: 7.5 μ s Gate 4: 0	Delay between trigger point and time gated period
[SENS[1]:]SWE[1] 2 3 4:TIME	Gate 1: 10 μ s Gate 2: 2.5 μ s Gate 3: 2.5 μ s Gate 4: 0	Length of time gated period for time gated measurements
<i>Trigger setup</i>		
TRIG[:SEQ[1]]:SOUR	INT1	Trigger source setup and acquisition mode continuous triggering
INIT:CONT	ON	
TRIG[:SEQ]:LEV:AUTO	ON	Enable automatic setting of the trigger level
TRIG[:SEQ]:LEV	AUTO	Automatic power level
TRIG[:SEQ]:SLOP	POS	Trigger event recognized on the rising edge of a signal
TRIG[:SEQ]:DEL	0 s	Delay between recognition of trigger event and start of a measurement
TRIG[:SEQ]:HOLD	1 μ s	Trigger holdoff
TRIG[:SEQ]:HYST	0	Hysteresis
TRIG[:SEQ]:QUAL:TIME	100 ns	Trigger qualification time
<i>Averaging</i>		

Table 19-20 RADar: U2040 X-Series presets (continued)

Command	Setting	Comment
[SENS [1] :] AVER:COUN:AUTO	ON	Auto-averaging enabled
<i>Video averaging</i>		
[SENS [1] :] AVER2	OFF	Video averaging disabled
<i>Step detection</i>		
[SENS [1] :] AVER:SDET	0	Step detection disabled
<i>Trace setup</i>		
[SENS [1] :] TRAC:OFFS:TIME <numeric_value>	-2.5 μ s	Delay between delayed trigger point and the start of the trace
[SENS [1] :] TRAC:TIME <numeric_value>	15 μ s	Length of the trace
<i>Reference level setup</i>		
TRAC [1] : DEF:TRAN:REF	10%, 90%	Transition reference levels
TRAC [1] : DEF:DUR:REF	50%	Pulse duration reference level

Table 19-21 RADar: U2040 X-Series presets for calc setup

Command	Setting
AVERage measurement mode	
<i>Calc setup</i>	
Calc1-4 feed	Gate 1
Calc1-4 measurement	Average
NORMal measurement mode	
<i>Calc setup</i>	
Calc1 feed	Gate 1
Calc1 measurement	Peak to average
Calc2 feed	Gate 1
Calc2 measurement	Peak
Calc3 feed 1	Gate 1
Calc3 measurement	Average
Calc3 feed 2	Gate 1
Calc3 measurement	Peak
Calc4 feed	Gate 1
Calc4 measurement	Average

WL802DOT11A

Table 19-22 shows the U2040 X-Series presets when <character_data> is set to WL802DOT11A.

Table 19-22 WL802DOT11A: U2040 X-Series presets

Command	Setting	Comment
<i>Frequency</i>		
[SENS[1]:]FREQ[:CW :FIX]	+5200.000 MHz	Frequency setting
AVERage measurement mode		
<i>Trigger setup</i>		
TRIG[:SEQ]:DEL	0	Delay between recognition of trigger event and start of a measurement
<i>Aperture duration</i>		
[SENS[1]:]SWE:APER	100 ms	Aperture duration
NORMal measurement mode		
<i>Sensor video bandwidth setup</i>		
[SENS[1]:]BAND BWID:VID	HIGH	Sensor video bandwidth
<i>Gate setup</i>		
[SENS[1]:]SWE[1] 2 3 4:OFF:TIME	Gate 1: 0 Gates 2 – 4: 0	Delay between trigger point and time gated period
[SENS[1]:]SWE[1] 2 3 4:TIME	Gate 1: 25 μ s Gates 2 – 4: 0	Length of time gated period for time gated measurements
<i>Trigger setup</i>		
TRIG[:SEQ[1]]:SOUR	INT1	Trigger source setup and acquisition mode continuous triggering
INIT:CONT	ON	
TRIG[:SEQ]:LEV:AUTO	ON	Enable automatic setting of the trigger level
TRIG[:SEQ]:LEV	AUTO	Automatic power level
TRIG[:SEQ]:SLOP	POS	Trigger event recognized on the rising edge of a signal
TRIG[:SEQ]:DEL	0 s	Delay between recognition of trigger event and start of a measurement
TRIG[:SEQ]:HOLD	1 μ s	Trigger holdoff
TRIG[:SEQ]:HYST	1	Hysteresis
TRIG[:SEQ]:QUAL:TIME	25 μ s	Trigger qualification time
<i>Averaging</i>		
[SENS[1]:]AVER:COUN:AUTO	ON	Auto-averaging enabled
<i>Video averaging</i>		

Table 19-22 WL802DOT11A: U2040 X-Series presets (continued)

Command	Setting	Comment
[SENS [1] :] AVER2	OFF	Video averaging disabled
<i>Step detection</i>		
[SENS [1] :] AVER:SDET	0	Step detection disabled
<i>Trace setup</i>		
[SENS [1] :] TRAC:OFFS:TIME <numeric_value>	0	Delay between delayed trigger point and the start of the trace
[SENS [1] :] TRAC:TIME <numeric_value>	100 μ s	Length of the trace
<i>Reference level setup</i>		
TRAC [1] : DEF:TRAN:REF	10%, 90%	Transition reference levels
TRAC [1] : DEF:DUR:REF	50%	Pulse duration reference level

Table 19-23 WL802DOT11A: U2040 X-Series presets for calc setup

Command	Setting
AVERage measurement mode	
<i>Calc setup</i>	
Calc1-4 feed	Gate 1
Calc1-4 measurement	Average
NORMal measurement mode	
<i>Calc setup</i>	
Calc1 feed	Gate 1
Calc1 measurement	Average
Calc2 feed	Gate 1
Calc2 measurement	Peak
Calc3 feed 1	Gate 1
Calc3 measurement	Average
Calc3 feed 2	Gate 1
Calc3 measurement	Peak
Calc4 feed	Gate 1
Calc4 measurement	Peak to average

WL802DOT11B/G

Table 19-24 shows the U2040 X-Series presets when <character_data> is set to WL802DOT11B/G.

Table 19-24 WL802DOT11B: U2040 X-Series presets

Command	Setting	Comment
<i>Frequency</i>		
[SENS[1]:]FREQ[:CW :FIX]	+2.400 GHz	Frequency setting
AVERage measurement mode		
<i>Trigger setup</i>		
TRIG[:SEQ]:DEL	0	Delay between recognition of trigger event and start of a measurement
<i>Aperture duration</i>		
[SENS[1]:]SWE:APER	100 ms	Aperture duration
NORMal measurement mode		
<i>Sensor video bandwidth setup</i>		
[SENS[1]:]BAND BWID:VID	HIGH	Sensor video bandwidth
<i>Gate setup</i>		
[SENS[1]:]SWE[1] 2 3 4:OFF:TIME	Gate 1: 0 Gates 2 – 4: 0	Delay between trigger point and time gated period
[SENS[1]:]SWE[1] 2 3 4:TIME	Gate 1: 100 μ s Gates 2 – 4: 0	Length of time gated period for time gated measurements
<i>Trigger setup</i>		
TRIG[:SEQ[1]]:SOUR	INT1	Trigger source setup and acquisition mode continuous triggering
INIT:CONT	ON	
TRIG[:SEQ]:LEV:AUTO	ON	Enable automatic setting of the trigger level
TRIG[:SEQ]:LEV	AUTO	Automatic power level
TRIG[:SEQ]:SLOP	POS	Trigger event recognized on the rising edge of a signal
TRIG[:SEQ]:DEL	0 s	Delay between recognition of trigger event and start of a measurement
TRIG[:SEQ]:HOLD	1 μ s	Trigger holdoff
TRIG[:SEQ]:HYST	1	Hysteresis
TRIG[:SEQ]:QUAL:TIME	25 μ s	Trigger qualification time
<i>Averaging</i>		
[SENS[1]:]AVER:COUN:AUTO	ON	Auto-averaging enabled
<i>Video averaging</i>		

Table 19-24 WL802DOT11B: U2040 X-Series presets (continued)

Command	Setting	Comment
[SENS [1] :] AVER2	OFF	Video averaging disabled
<i>Step detection</i>		
[SENS [1] :] AVER:SDET	0	Step detection disabled
<i>Trace setup</i>		
[SENS [1] :] TRAC:OFFS:TIME <numeric_value>	0	Delay between delayed trigger point and the start of the trace
[SENS [1] :] TRAC:TIME <numeric_value>	100 μ s	Length of the trace
<i>Reference level setup</i>		
TRAC [1] : DEF:TRAN:REF	10%, 90%	Transition reference levels
TRAC [1] : DEF:DUR:REF	50%	Pulse duration reference level

Table 19-25 WL802DOT11B: U2040 X-Series presets for calc setup

Command	Setting
AVERage measurement mode	
<i>Calc setup</i>	
Calc1-4 feed	Gate 1
Calc1-4 measurement	Average
NORMal measurement mode	
<i>Calc setup</i>	
Calc1 feed	Gate 1
Calc1 measurement	Average
Calc2 feed	Gate 1
Calc2 measurement	Peak
Calc3 feed 1	Gate 1
Calc3 measurement	Average
Calc3 feed 2	Gate 1
Calc3 measurement	Peak
Calc4 feed	Gate 1
Calc4 measurement	Peak to average

XEVD0

Table 19-26 shows the U2040 X-Series presets when <character_data> is set to XEVD0.

Table 19-26 XEVD0: U2040 X-Series presets

Command	Setting	Comment
<i>Frequency</i>		
[SENS[1]:]FREQ[:CW :FIX]	+1900.000 MHz	Frequency setting
AVERage measurement mode		
<i>Trigger setup</i>		
TRIG[:SEQ]:DEL	0	Delay between recognition of trigger event and start of a measurement
<i>Aperture duration</i>		
[SENS[1]:]SWE:APER	1.666 ms (one slot) 26.67 ms (one frame)	Aperture duration
NORMAL measurement mode		
<i>Sensor video bandwidth setup</i>		
[SENS[1]:]BAND BWID:VID	LOW	Sensor video bandwidth
<i>Gate setup</i>		
[SENS[1]:]SWE[1] 2 3 4:OFF:TIME	Gate 1: 10 μ s Gates 2 – 4: 0	Delay between trigger point and time gated period
[SENS[1]:]SWE[1] 2 3 4:TIME	Gate 1: 810 μ s Gates 2 – 4: 0	Length of time gated period for time gated measurements
<i>Trigger setup</i>		
TRIG[:SEQ[1]]:SOUR	INT1	Trigger source setup and acquisition mode continuous triggering
INIT:CONT	ON	
TRIG[:SEQ]:LEV:AUTO	ON	Enable automatic setting of the trigger level
TRIG[:SEQ]:LEV	AUTO	Power level
TRIG[:SEQ]:SLOP	POS	Trigger event recognized on the rising edge of a signal
TRIG[:SEQ]:DEL	0 s	Delay between recognition of trigger event and start of a measurement
TRIG[:SEQ]:HOLD	1 ms	Trigger holdoff
TRIG[:SEQ]:HYST	0	Hysteresis
TRIG[:SEQ]:QUAL:TIME	100 ns	Trigger qualification time
<i>Averaging</i>		
[SENS[1]:]AVER:COUN:AUTO	ON	Auto-averaging enabled

Table 19-26 XEVD0: U2040 X-Series presets (continued)

Command	Setting	Comment
<i>Video averaging</i>		
[SENS [1] :] AVER2	OFF	Video averaging disabled
<i>Step detection</i>		
[SENS [1] :] AVER: SDET	0	Step detection disabled
<i>Trace setup</i>		
[SENS [1] :] TRAC: OFFS: TIME <numeric_value>	-40 μ s	Delay between delayed trigger point and the start of the trace
[SENS [1] :] TRAC: TIME <numeric_value>	1 ms	Length of the trace
<i>Reference level setup</i>		
TRAC [1] : DEF: TRAN: REF	10%, 90%	Transition reference levels
TRAC [1] : DEF: DUR: REF	50%	Pulse duration reference level

Table 19-27 XEVD0: U2040 X-Series presets for calc setup

Command	Setting
AVERage measurement mode	
<i>Calc setup</i>	
Calc1-4 feed	Gate 1
Calc1-4 measurement	Average
NORMal measurement mode	
<i>Calc setup</i>	
Calc1 feed	Gate 1
Calc1 measurement	Peak
Calc2 feed	Gate 1
Calc2 measurement	Average
Calc3 feed 1	Gate 1
Calc3 measurement	Peak
Calc3 feed 2	Gate 1
Calc3 measurement	Average
Calc4 feed	Gate 1
Calc4 measurement	Peak to average

XEVDV

Table 19-28 shows the U2040 X-Series presets when <character_data> is set to XEVDV.

Table 19-28 XEVDV: U2040 X-Series presets

Command	Setting	Comment
<i>Frequency</i>		
[SENS[1]:]FREQ[:CW :FIX]	+1900.000 MHz	Frequency setting
AVERage measurement mode		
<i>Trigger setup</i>		
TRIG[:SEQ]:DEL	0	Delay between recognition of trigger event and start of a measurement
<i>Aperture duration</i>		
[SENS[1]:]SWE:APER	1.25 ms	Aperture duration
NORMal measurement mode		
<i>Sensor video bandwidth setup</i>		
[SENS[1]:]BAND BWID:VID	LOW	Sensor video bandwidth
<i>Gate setup</i>		
[SENS[1]:]SWE[1] 2 3 4:OFF:TIME	Gate 1: 10 μ s Gates 2 – 4: 0	Delay between trigger point and time gated period
[SENS[1]:]SWE[1] 2 3 4:TIME	Gate 1: 810 μ s Gates 2 – 4: 0	Length of time gated period for time gated measurements
<i>Trigger setup</i>		
TRIG[:SEQ[1]]:SOUR	INT1	Trigger source setup and acquisition mode continuous triggering
INIT:CONT	ON	
TRIG[:SEQ]:LEV:AUTO	ON	Enable automatic setting of the trigger level
TRIG[:SEQ]:LEV	AUTO	Power level
TRIG[:SEQ]:SLOP	POS	Trigger event recognized on the rising edge of a signal
TRIG[:SEQ]:DEL	0 s	Delay between recognition of trigger event and start of a measurement
TRIG[:SEQ]:HOLD	1 ms	Trigger holdoff
TRIG[:SEQ]:HYST	0	Hysteresis
TRIG[:SEQ]:QUAL:TIME	100 ns	Trigger qualification time
<i>Averaging</i>		
[SENS[1]:]AVER:COUN:AUTO	ON	Auto-averaging enabled
<i>Video averaging</i>		

Table 19-28 XEVDV: U2040 X-Series presets

Command	Setting	Comment
[SENS [1] :] AVER2	OFF	Video averaging disabled
<i>Step detection</i>		
[SENS [1] :] AVER:SDET	0	Step detection disabled
<i>Trace setup</i>		
[SENS [1] :] TRAC:OFFS:TIME <numeric_value>	-40 μ s	Delay between delayed trigger point and the start of the trace
[SENS [1] :] TRAC:TIME <numeric_value>	1 ms	Length of the trace
<i>Reference level setup</i>		
TRAC [1] : DEF:TRAN:REF	10%, 90%	Transition reference levels
TRAC [1] : DEF:DUR:REF	50%	Pulse duration reference level

Table 19-29 XEVDV: U2040 X-Series presets for calc setup

Command	Setting
AVERAge measurement mode	
<i>Calc setup</i>	
Calc1-4 feed	Gate 1
Calc1-4 measurement	Average
NORMAl measurement mode	
<i>Calc setup</i>	
Calc1 feed	Gate 1
Calc1 measurement	Peak
Calc2 feed	Gate 1
Calc2 measurement	Average
Calc3 feed 1	Gate 1
Calc3 measurement	Peak
Calc3 feed 2	Gate 1
Calc3 measurement	Average
Calc4 feed	Gate 1
Calc4 measurement	Peak to average

TDSCdma

Table 19-30 shows the U2040 X-Series presets when <character_data> is set to TDSCdma.

Table 19-30 TDSCdma: U2040 X-Series presets

Command	Setting	Comment
<i>Frequency</i>		
[SENS[1]:]FREQ[:CW :FIX]	+1900.000 MHz	Frequency setting
AVERage measurement mode		
<i>Trigger setup</i>		
TRIG[:SEQ]:DEL	0	Delay between recognition of trigger event and start of a measurement
<i>Aperture duration</i>		
[SENS[1]:]SWE:APER	10 ms	Aperture duration
NORMAL measurement mode		
<i>Sensor video bandwidth setup</i>		
[SENS[1]:]BAND BWID:VID	LOW	Sensor video bandwidth
<i>Gate setup</i>		
[SENS[1]:]SWE[1] 2 3 4:OFF:TIME	Gate 1: 10 μ s Gates 2 – 4: 0	Delay between trigger point and time gated period
[SENS[1]:]SWE[1] 2 3 4:TIME	Gate 1: 810 μ s Gates 2 – 4: 0	Length of time gated period for time gated measurements
<i>Trigger setup</i>		
TRIG[:SEQ[1]]:SOUR	INT1	Trigger source setup and acquisition mode continuous triggering
INIT:CONT	ON	
TRIG[:SEQ]:LEV:AUTO	ON	Enable automatic setting of the trigger level
TRIG[:SEQ]:LEV	AUTO	Power level
TRIG[:SEQ]:SLOP	POS	Trigger event recognized on the rising edge of a signal
TRIG[:SEQ]:DEL	0 s	Delay between recognition of trigger event and start of a measurement
TRIG[:SEQ]:HOLD	1 ms	Trigger holdoff
TRIG[:SEQ]:HYST	0	Hysteresis
TRIG[:SEQ]:QUAL:TIME	100 ns	Trigger qualification time
<i>Averaging</i>		
[SENS[1]:]AVER:COUN:AUTO	ON	Auto-averaging enabled
<i>Video averaging</i>		

Table 19-30 TDSCdma: U2040 X-Series presets (continued)

Command	Setting	Comment
[SENS[1]:]AVER2	OFF	Video averaging disabled
<i>Step detection</i>		
[SENS[1]:]AVER:SDET	0	Step detection disabled
<i>Trace setup</i>		
[SENS[1]:]TRAC:OFFS:TIME <numeric_value>	-40 μ s	Delay between delayed trigger point and the start of the trace
[SENS[1]:]TRAC:TIME <numeric_value>	1 ms	Length of the trace
<i>Reference level setup</i>		
TRAC[1]:DEF:TRAN:REF	10%, 90%	Transition reference levels
TRAC[1]:DEF:DUR:REF	50%	Pulse duration reference level

Table 19-31 TDSCdma: U2040 X-Series presets for calc setup

Command	Setting
AVERAge measurement mode	
<i>Calc setup</i>	
Calc1-4 feed	Gate 1
Calc1-4 measurement	Average
NORMAl measurement mode	
<i>Calc setup</i>	
Calc1 feed	Gate 1
Calc1 measurement	Peak
Calc2 feed	Gate 1
Calc2 measurement	Average
Calc3 feed 1	Gate 1
Calc3 measurement	Peak
Calc3 feed 1	Gate 1
Calc3 measurement	Average
Calc4 feed	Gate 1
Calc4 measurement	Peak to average

DVB

Table 19-32 shows the U2040 X-Series presets when <character_data> is set to DVB.

Table 19-32 DVB: U2040 X-Series presets

Command	Setting	Comment
<i>Frequency</i>		
[SENS[1]:]FREQ[:CW :FIX]	+660.000 MHz	Frequency setting
AVERage measurement mode		
<i>Trigger setup</i>		
TRIG[:SEQ]:DEL	0	Delay between recognition of trigger event and start of a measurement
<i>Aperture duration</i>		
[SENS[1]:]SWE:APER	15 ms	Aperture duration
NORMal measurement mode		
<i>Sensor video bandwidth setup</i>		
[SENS[1]:]BAND BWID:VID	OFF	Sensor video bandwidth
<i>Gate setup</i>		
[SENS[1]:]SWE[1] 2 3 4:OFF:TIME	Gate 1: 10 μ s Gate 2: 0 Gates 3 – 4: 0	Delay between trigger point and time gated period
[SENS[1]:]SWE[1] 2 3 4:TIME	Gate 1: 15 ms Gate 2: 90 ms Gates 3 – 4: 0	Length of time gated period for time gated measurements
<i>Trigger setup</i>		
TRIG[:SEQ[1]]:SOUR	INT1	Trigger source setup and acquisition mode continuous triggering
INIT:CONT	ON	
TRIG[:SEQ]:LEV:AUTO	OFF	Disable automatic setting of the trigger level
TRIG[:SEQ]:LEV	-15 dBm	Power level
TRIG[:SEQ]:SLOP	POS	Trigger event recognized on the rising edge of a signal
TRIG[:SEQ]:DEL	0 s	Delay between recognition of trigger event and start of a measurement
TRIG[:SEQ]:HOLD	20 ms	Trigger holdoff
TRIG[:SEQ]:HYST	0	Hysteresis
TRIG[:SEQ]:QUAL:TIME	100 ns	Trigger qualification time
<i>Averaging</i>		
[SENS[1]:]AVER:COUN:AUTO	ON	Auto-averaging enabled
<i>Video averaging</i>		

Table 19-32 DVB: U2040 X-Series presets (continued)

Command	Setting	Comment
[SENS[1]:]AVER2	OFF	Video averaging disabled
<i>Step detection</i>		
[SENS[1]:]AVER:SDET	1	Step detection enabled
<i>Trace setup</i>		
[SENS[1]:]TRAC:OFFS:TIME <numeric_value>	0	Delay between delayed trigger point and the start of the trace
[SENS[1]:]TRAC:TIME <numeric_value>	100 μ s	Length of the trace
<i>Reference level setup</i>		
TRAC[1]:DEF:TRAN:REF	10%, 90%	Transition reference levels
TRAC[1]:DEF:DUR:REF	50%	Pulse duration reference level

Table 19-33 TDVB: U2040 X-Series presets for calc setup

Command	Setting
AVERage measurement mode	
<i>Calc setup</i>	
Calc1-4 feed	Gate 1
Calc1-4 measurement	Average
NORMal measurement mode	
<i>Calc setup</i>	
Calc1 feed	Gate 1
Calc1 measurement	Average
Calc2 feed	Gate 1
Calc2 measurement	Peak to average
Calc3 feed 1	Gate 1
Calc3 measurement	Average
Calc3 feed 2	Gate 1
Calc3 measurement	Peak to average
Calc4 feed	Gate 2
Calc4 measurement	Average

HIPERLAN2

Table 19-34 shows the U2040 X-Series presets when <character_data> is set to HIPERLAN2.

Table 19-34 HIPERLAN2: U2040 X-Series presets

Command	Setting	Comment
<i>Frequency</i>		
[SENS[1]:]FREQ[:CW :FIX]	+5200.000 MHz	Frequency setting
AVERage measurement mode		
<i>Trigger setup</i>		
TRIG[:SEQ]:DEL	0	Delay between recognition of trigger event and start of a measurement
<i>Aperture duration</i>		
[SENS[1]:]SWE:APER	100 ms	Aperture duration
NORMal measurement mode		
<i>Sensor video bandwidth setup</i>		
[SENS[1]:]BAND BWID:VID	HIGH	Sensor video bandwidth
<i>Gate setup</i>		
[SENS[1]:]SWE[1] 2 3 4:OFF:TIME	Gate 1: 0 Gates 2 – 4: 0	Delay between trigger point and time gated period
[SENS[1]:]SWE[1] 2 3 4:TIME	Gate 1: 25 μ s Gates 2 – 4: 0	Length of time gated period for time gated measurements
<i>Trigger setup</i>		
TRIG[:SEQ[1]]:SOUR	INT1	Trigger source setup and acquisition mode continuous triggering
INIT:CONT	ON	
TRIG[:SEQ]:LEV:AUTO	ON	Enable automatic setting of the trigger level
TRIG[:SEQ]:LEV	AUTO	Power level
TRIG[:SEQ]:SLOP	POS	Trigger event recognized on the rising edge of a signal
TRIG[:SEQ]:DEL	0 s	Delay between recognition of trigger event and start of a measurement
TRIG[:SEQ]:HOLD	1 μ s	Trigger holdoff
TRIG[:SEQ]:HYST	0	Hysteresis
TRIG[:SEQ]:QUAL:TIME	100 ns	Trigger qualification time
<i>Averaging</i>		
[SENS[1]:]AVER:COUN:AUTO	ON	Auto-averaging enabled
<i>Video averaging</i>		

Table 19-34 HIPERLAN2: U2040 X-Series presets (continued)

Command	Setting	Comment
[SENS [1] :] AVER2	OFF	Video averaging disabled
<i>Step detection</i>		
[SENS [1] :] AVER:SDET	0	Step detection disabled
<i>Trace setup</i>		
[SENS [1] :] TRAC:OFFS:TIME <numeric_value>	0	Delay between delayed trigger point and the start of the trace
[SENS [1] :] TRAC:TIME <numeric_value>	100 μ s	Length of the trace
<i>Reference level setup</i>		
TRAC [1] : DEF:TRAN:REF	10%, 90%	Transition reference levels
TRAC [1] : DEF:DUR:REF	50%	Pulse duration reference level

Table 19-35 HIPERLAN2: U2040 X-Series presets for calc setup

Command	Setting
AVERage measurement mode	
<i>Calc setup</i>	
Calc1-4 feed	Gate 1
Calc1-4 measurement	Average
NORMal measurement mode	
<i>Calc setup</i>	
Calc1 feed	Gate 1
Calc1 measurement	Average
Calc2 feed	Gate 1
Calc2 measurement	Peak
Calc3 feed 1	Gate 1
Calc3 measurement	Average
Calc3 feed 2	Gate 1
Calc3 measurement	Peak
Calc4 feed	Gate 1
Calc4 measurement	Peak to average

WIMAX

Table 19-36 shows the U2040 X-Series presets when <character_data> is set to WIMAX.

Table 19-36 WIMAX: U2040 X-Series presets

Command	Setting	Comment
<i>Frequency</i>		
[SENS[1]:]FREQ[:CW :FIX]	+3.5 GHz	Frequency setting
AVERage measurement mode		
<i>Trigger setup</i>		
TRIG[:SEQ]:DEL	0	Delay between recognition of trigger event and start of a measurement
<i>Aperture duration</i>		
[SENS[1]:]SWE:APER	100 ms	Aperture duration
NORMal measurement mode		
<i>Sensor video bandwidth setup</i>		
[SENS[1]:]BAND BWID:VID	OFF	Sensor video bandwidth
<i>Gate setup</i>		
[SENS[1]:]SWE[1] 2 3 4:OFF:TIME	Gate 1: 0 Gates 2: 102 μ s Gates 3 – 4: 0	Delay between trigger point and time gated period
[SENS[1]:]SWE[1] 2 3 4:TIME	Gate 1: 102 μ s Gate 2: 306 μ s Gates 3 – 4: 0	Length of time gated period for time gated measurements
<i>Trigger setup</i>		
TRIG[:SEQ[1]]:SOUR	INT1	Trigger source setup and acquisition mode continuous triggering
INIT:CONT	ON	
TRIG[:SEQ]:LEV:AUTO	ON	Enable automatic setting of the trigger level
TRIG[:SEQ]:LEV	AUTO	Power level
TRIG[:SEQ]:SLOP	POS	Trigger event recognized on the rising edge of a signal
TRIG[:SEQ]:DEL	0 s	Delay between recognition of trigger event and start of a measurement
TRIG[:SEQ]:HOLD	4 ms	Trigger holdoff
TRIG[:SEQ]:HYST	0	Hysteresis
TRIG[:SEQ]:QUAL:TIME	8 μ s	Trigger qualification time
<i>Averaging</i>		
[SENS[1]:]AVER:COUN:AUTO	ON	Auto-averaging enabled

Table 19-36 WIMAX: U2040 X-Series presets (continued)

Command	Setting	Comment
<i>Video averaging</i>		
[SENS [1] :] AVER2	OFF	Video averaging disabled
<i>Step detection</i>		
[SENS [1] :] AVER: SDET	0	Step detection disabled
<i>Trace setup</i>		
[SENS [1] :] TRAC: OFFS: TIME <numeric_value>	-0.2 ms	Delay between delayed trigger point and the start of the trace
[SENS [1] :] TRAC: TIME <numeric_value>	3 ms	Length of the trace
<i>Reference level setup</i>		
TRAC [1] : DEF: TRAN: REF	10%, 90%	Transition reference levels
TRAC [1] : DEF: DUR: REF	50%	Pulse duration reference level

Table 19-37 WIMAX: U2040 X-Series presets for calc setup

Command	Setting
AVERage measurement mode	
<i>Calc setup</i>	
Calc1-4 feed	Gate 1
Calc1-4 measurement	Average
NORMal measurement mode	
<i>Calc setup</i>	
Calc1 feed	Gate 1
Calc1 measurement	Average
Calc2 feed	Gate 2
Calc2 measurement	Average
Calc3 feed 1	Gate 1
Calc3 measurement	Peak to average
Calc3 feed 2	Gate 2
Calc3 measurement	Average
Calc4 feed	Gate 2
Calc4 measurement	Peak to average

HSDPA

Table 19-38 shows the U2040 X-Series presets when <character_data> is set to HSDPA.

Table 19-38 HSDPA: U2040 X-Series presets

Command	Setting	Comment
<i>Frequency</i>		
[SENS[1]:]FREQ[:CW :FIX]	+1900.000 MHz	Frequency setting
AVERage measurement mode		
<i>Trigger setup</i>		
TRIG[:SEQ]:DEL	0	Delay between recognition of trigger event and start of a measurement
<i>Aperture duration</i>		
[SENS[1]:]SWE:APER	10 ms	Aperture duration
NORMal measurement mode		
<i>Sensor video bandwidth setup</i>		
[SENS[1]:]BAND BWID:VID	OFF	Sensor video bandwidth
<i>Gate setup</i>		
[SENS[1]:]SWE[1] 2 3 4:OFF:TIME	Gate 1: 0 s Gates 2 – 4: 0	Delay between trigger point and time gated period
[SENS[1]:]SWE[1] 2 3 4:TIME	Gate 1: 10 ms Gates 2 – 4: 0	Length of time gated period for time gated measurements
<i>Trigger setup</i>		
TRIG[:SEQ[1]]:SOUR	INT1	Trigger source setup and acquisition mode continuous triggering
INIT:CONT	ON	
TRIG[:SEQ]:LEV:AUTO	ON	Enable automatic setting of the trigger level
TRIG[:SEQ]:LEV	AUTO	Automatic power level
TRIG[:SEQ]:SLOP	POS	Trigger event recognized on the rising edge of a signal
TRIG[:SEQ]:DEL	0 s	Delay between recognition of trigger event and start of a measurement
TRIG[:SEQ]:HOLD	1 μ s	Trigger holdoff
TRIG[:SEQ]:HYST	0	Hysteresis
TRIG[:SEQ]:QUAL:TIME	100 ns	Trigger qualification time
<i>Averaging</i>		
[SENS[1]:]AVER:COUN:AUTO	ON	Auto-averaging enabled

Table 19-38 HSDPA: U2040 X-Series presets (continued)

Command	Setting	Comment
<i>Video averaging</i>		
[SENS [1] :] AVER2	OFF	Video averaging disabled
<i>Step detection</i>		
[SENS [1] :] AVER: SDET	0	Step detection disabled
<i>Trace setup</i>		
[SENS [1] :] TRAC: OFFS: TIME <numeric_value>	0	Delay between delayed trigger point and the start of the trace
[SENS [1] :] TRAC: TIME <numeric_value>	100 μ s	Length of the trace
<i>Reference level setup</i>		
TRAC [1] : DEF: TRAN: REF	10%, 90%	Transition reference levels
TRAC [1] : DEF: DUR: REF	50%	Pulse duration reference level

Table 19-39 HSDPA: U2040 X-Series presets for calc setup

Command	Setting
AVERage measurement mode	
<i>Calc setup</i>	
Calc1-4 feed	Gate 1
Calc1-4 measurement	Average
NORMal measurement mode	
<i>Calc setup</i>	
Calc1 feed	Gate 1
Calc1 measurement	Average
Calc2 feed	Gate 1
Calc2 measurement	Peak
Calc3 feed 1	Gate 1
Calc3 measurement	Average
Calc3 feed 2	Gate 1
Calc3 measurement	Peak
Calc4 feed	Gate 1
Calc4 measurement	Peak to average

DME

Table 19-40 shows the U2040 X-Series presets when <character_data> is set to DME.

Table 19-40 DME: U2040 X-Series presets

Command	Setting	Comment
<i>Frequency</i>		
[SENS[1]:]FREQ[:CW :FIX]	+1.1 GHz	Frequency setting
AVERage measurement mode		
<i>Trigger setup</i>		
TRIG[:SEQ]:DEL	-2 μ s	Delay between recognition of trigger event and start of a measurement
<i>Aperture duration</i>		
[SENS[1]:]SWE:APER	50 μ s	Aperture duration
NORMal measurement mode		
<i>Sensor video bandwidth setup</i>		
[SENS[1]:]BAND BWID:VID	OFF	Sensor video bandwidth
<i>Gate setup</i>		
[SENS[1]:]SWE[1] 2 3 4:OFF:TIME	Gate 1: -2 μ s Gate 2: 8 μ s Gates 3 - 4: 0	Delay between trigger point and time gated period
[SENS[1]:]SWE[1] 2 3 4:TIME	Gate 1: 8 μ s Gate 2: 50 μ s Gates 3 - 4: 0	Length of time gated period for time gated measurements
<i>Trigger setup</i>		
TRIG[:SEQ[1]]:SOUR	INT1	Trigger source setup and acquisition mode continuous triggering
INIT:CONT	ON	
TRIG[:SEQ]:LEV:AUTO	ON	Enable automatic setting of the trigger level
TRIG[:SEQ]:LEV	AUTO	Power level
TRIG[:SEQ]:SLOP	POS	Trigger event recognized on the rising edge of a signal
TRIG[:SEQ]:DEL	0 s	Delay between recognition of trigger event and start of a measurement
TRIG[:SEQ]:HOLD	50 μ s	Trigger holdoff
TRIG[:SEQ]:HYST	0	Hysteresis
TRIG[:SEQ]:QUAL:TIME	100 ns	Trigger qualification time
<i>Averaging</i>		
[SENS[1]:]AVER:COUN:AUTO	ON	Auto-averaging enabled
<i>Video averaging setup</i>		

Table 19-40 DME: U2040 X-Series presets (continued)

Command	Setting	Comment
[SENS[1]:]AVER2[:STAT]	ON	Video averaging is enabled
<i>Step detection</i>		
[SENS[1]]:AVER:SDET	1	Step detection enabled
<i>Trace setup</i>		
[SENS[1]:]TRAC:OFFS:TIME <numeric_value>	-3 μ s	Delay between delayed trigger point and the start of the trace
[SENS[1]:]TRAC:TIME <numeric_value>	53 μ s	Length of the trace
<i>Reference level setup</i>		
TRAC[1]:DEF:TRAN:REF	1%, 81%	Transition reference levels
TRAC[1]:DEF:DUR:REF	25%	Pulse duration reference level

Table 19-41 DME: U2040 X-Series presets for calc setup

Command	Setting
AVERage measurement mode	
<i>Calc setup</i>	
Calc1-4 feed	Gate 1
Calc1-4 measurement	Average
NORMal measurement mode	
<i>Calc setup</i>	
Calc1 feed	Gate 1
Calc1 measurement	Average
Calc2 feed	Gate 1
Calc2 measurement	Peak
Calc3 feed 1	Gate 2
Calc3 measurement	Average
Calc3 feed 2	Gate 1
Calc3 measurement	Peak
Calc4 feed	Gate 2
Calc4 measurement	Peak

DMEPRT

Table 19-42 shows the U2040 X-Series presets when <character_data> is set to DMEPRT.

Table 19-42 DMEPRT: U2040 X-Series presets

Command	Setting	Comment
<i>Frequency</i>		
[SENS[1]:]FREQ[:CW :FIX]	+1.1 GHz	Frequency setting
AVERage measurement mode		
<i>Trigger setup</i>		
TRIG[:SEQ]:DEL	0	Delay between recognition of trigger event and start of a measurement
<i>Aperture duration</i>		
[SENS[1]:]SWE:APER	50 μ s	Aperture duration
NORMal measurement mode		
<i>Sensor video bandwidth setup</i>		
[SENS[1]:]BAND BWID:VID	OFF	Sensor video bandwidth
<i>Gate setup</i>		
[SENS[1]:]SWE[1] 2 3 4:OFF:TIME	Gate 1: 0 μ s Gate 2: 8 μ s Gates 3 - 4: 0	Delay between trigger point and time gated period
[SENS[1]:]SWE[1] 2 3 4:TIME	Gate 1: 6 μ s Gate 2: 50 μ s Gates 3 - 4: 0	Length of time gated period for time gated measurements
<i>Trigger setup</i>		
TRIG[:SEQ[1]]:SOUR	INT1	Trigger source setup and acquisition mode continuous triggering
INIT:CONT	ON	
TRIG[:SEQ]:LEV:AUTO	ON	Enable automatic setting of the trigger level
TRIG[:SEQ]:LEV	AUTO	Power level
TRIG[:SEQ]:SLOP	POS	Trigger event recognized on the rising edge of a signal
TRIG[:SEQ]:DEL	0 s	Delay between recognition of trigger event and start of a measurement
TRIG[:SEQ]:HOLD	50 μ s	Trigger holdoff
TRIG[:SEQ]:HYST	0	Hysteresis
TRIG[:SEQ]:QUAL:TIME	100 ns	Trigger qualification time
<i>Averaging</i>		
[SENS[1]:]AVER:COUN:AUTO	ON	Auto-averaging enabled

Table 19-42 DMEPRT: U2040 X-Series presets (continued)

Command	Setting	Comment
<i>Video averaging setup</i>		
[SENS [1] :] AVER2 [: STAT]	ON	Video averaging is enabled
<i>Step detection</i>		
[SENS [1] :] AVER: SDET	1	Step detection enabled
<i>Trace setup</i>		
[SENS [1] :] TRAC: OFFS: TIME <numeric_value>	-2 μ s	Delay between delayed trigger point and the start of the trace
[SENS [1] :] TRAC: TIME <numeric_value>	5 μ s	Length of the trace
<i>Reference level setup</i>		
TRAC [1] : DEF: TRAN: REF	0.25%, 9%	Transition reference levels
TRAC [1] : DEF: DUR: REF	25%	Pulse duration reference level

Table 19-43 DMEPRT: U2040 X-Series presets for calc setup

Command	Setting
AVERage measurement mode	
<i>Calc setup</i>	
Calc1-4 feed	Gate 1
Calc1-4 measurement	Average
NORMal measurement mode	
<i>Calc setup</i>	
Calc1 feed	Gate 1
Calc1 measurement	Average
Calc2 feed	Gate 1
Calc2 measurement	Peak
Calc3 feed 1	Gate 2
Calc3 measurement	Average
Calc3 feed 2	Gate 1
Calc3 measurement	Peak
Calc4 feed	Gate 2
Calc4 measurement	Peak

LTEFDD

Table 19-44 shows the U2040 X-Series presets when <character_data> is set to LTEFDD.

Table 19-44 LTEFDD: U2040 X-Series presets

Command	Setting	Comment
<i>Frequency</i>		
[SENS[1]:]FREQ[:CW :FIX]	+2.0 GHz	Frequency setting
AVERage measurement mode		
<i>Trigger setup</i>		
TRIG[:SEQ]:DEL	0	Delay between recognition of trigger event and start of a measurement
<i>Aperture duration</i>		
[SENS[1]:]SWE:APER	10 ms	Aperture duration
NORMal measurement mode		
<i>Sensor video bandwidth setup</i>		
[SENS[1]:]BAND BWID:VID	OFF	Sensor video bandwidth
<i>Gate setup</i>		
[SENS[1]:]SWE[1] 2 3 4:OFF:TIME	Gates 1 – 4: 0	Delay between trigger point and time gated period
[SENS[1]:]SWE[1] 2 3 4:TIME	Gate 1: 10.0 ms Gates 2 – 4: 0	Length of time gated period for time gated measurements
<i>Trigger setup</i>		
TRIG[:SEQ[1]]:SOUR	INT1	Trigger source setup and acquisition mode continuous triggering
INIT:CONT	ON	
TRIG[:SEQ]:LEV:AUTO	ON	Enable automatic setting of the trigger level
TRIG[:SEQ]:LEV	AUTO	Power level
TRIG[:SEQ]:SLOP	POS	Trigger event recognized on the rising edge of a signal
TRIG[:SEQ]:DEL	0 s	Delay between recognition of trigger event and start of a measurement
TRIG[:SEQ]:HOLD	1 μ s	Trigger holdoff
TRIG[:SEQ]:HYST	0	Hysteresis
TRIG[:SEQ]:QUAL:TIME	100 ns	Trigger qualification time
<i>Averaging</i>		
[SENS[1]:]AVER:COUN:AUTO	ON	Auto-averaging enabled
<i>Video averaging setup</i>		

Table 19-44 LTFDD: U2040 X-Series presets (continued)

Command	Setting	Comment
[SENS [1] :] AVER2 [: STAT]	OFF	Video averaging is disabled
<i>Step detection</i>		
[SENS [1] :] AVER : SDET	0	Step detection is disabled
<i>Trace setup</i>		
[SENS [1] :] TRAC : OFFS : TIME <numeric_value>	0	Delay between delayed trigger point and the start of the trace
[SENS [1] :] TRAC : TIME <numeric_value>	100 μ s	Length of the trace
<i>Reference level setup</i>		
TRAC [1] : DEF : TRAN : REF	10%, 90%	Transition reference levels
TRAC [1] : DEF : DUR : REF	50%	Pulse duration reference level

Table 19-45 LTFDD: U2040 X-Series presets for calc setup

Command	Setting
AVERage measurement mode	
<i>Calc setup</i>	
Calc1-4 feed	Gate 1
Calc1-4 measurement	Average
NORMal measurement mode	
<i>Calc setup</i>	
Calc1 feed	Gate 1
Calc1 measurement	Average
Calc2 feed	Gate 1
Calc2 measurement	Peak
Calc3 feed 1	Gate 1
Calc3 measurement	Average
Calc3 feed 2	Gate 1
Calc3 measurement	Peak
Calc4 feed	Gate 1
Calc4 measurement	Peak to average

LTETDD

Table 19-44 shows the U2040 X-Series presets when <character_data> is set to LTETDD.

Table 19-46 LTETDD: U2040 X-Series presets

Command	Setting	Comment
<i>Frequency</i>		
[SENS[1]:]FREQ[:CW :FIX]	+2.0 GHz	Frequency setting
AVERage measurement mode		
<i>Trigger setup</i>		
TRIG[:SEQ]:DEL	0	Delay between recognition of trigger event and start of a measurement
<i>Aperture duration</i>		
[SENS[1]:]SWE:APER	10 ms	Aperture duration
NORMAL measurement mode		
<i>Sensor video bandwidth setup</i>		
[SENS[1]:]BAND BWID:VID	OFF	Sensor video bandwidth
<i>Gate setup</i>		
[SENS[1]:]SWE[1] 2 3 4:OFF:TIME	Gates 1 – 4: 0	Delay between trigger point and time gated period
[SENS[1]:]SWE[1] 2 3 4:TIME	Gate 1: 1.2 ms Gate 2: 10 ms Gates 3 – 4: 0	Length of time gated period for time gated measurements
<i>Trigger setup</i>		
TRIG[:SEQ[1]]:SOUR	INT1	Trigger source setup and acquisition mode continuous triggering
INIT:CONT	ON	
TRIG[:SEQ]:LEV:AUTO	ON	Enable automatic setting of the trigger level
TRIG[:SEQ]:LEV	AUTO	Power level
TRIG[:SEQ]:SLOP	POS	Trigger event recognized on the rising edge of a signal
TRIG[:SEQ]:DEL	0 s	Delay between recognition of trigger event and start of a measurement
TRIG[:SEQ]:HOLD	4 ms	Trigger holdoff
TRIG[:SEQ]:HYST	0	Hysteresis
TRIG[:SEQ]:QUAL:TIME	25 μ s	Trigger qualification time
<i>Averaging</i>		
[SENS[1]:]AVER:COUN:AUTO	ON	Auto-averaging enabled

Table 19-46 LTETDD: U2040 X-Series presets (continued)

Command	Setting	Comment
<i>Video averaging setup</i>		
[SENS [1] :] AVER2 [: STAT]	OFF	Video averaging is disabled
<i>Step detection</i>		
[SENS [1] :] AVER: SDET	0	Step detection is disabled
<i>Trace setup</i>		
[SENS [1] :] TRAC: OFFS: TIME <numeric_value>	-0.2 ms	Delay between delayed trigger point and the start of the trace
[SENS [1] :] TRAC: TIME <numeric_value>	11 ms	Length of the trace
<i>Reference level setup</i>		
TRAC [1] : DEF: TRAN: REF	10%, 90%	Transition reference levels
TRAC [1] : DEF: DUR: REF	50%	Pulse duration reference level

Table 19-47 LTETDD: U2040 X-Series presets for calc setup

Command	Setting
AVERage measurement mode	
<i>Calc setup</i>	
Calc1-4 feed	Gate 1
Calc1-4 measurement	Average
NORMAL measurement mode	
<i>Calc setup</i>	
Calc1 feed	Gate 1
Calc1 measurement	Average
Calc2 feed	Gate 1
Calc2 measurement	Average
Calc3 feed 1	Gate 1
Calc3 measurement	Peak to average
Calc3 feed 2	Gate 1
Calc3 measurement	Average
Calc4 feed	Gate 1
Calc4 measurement	Peak to average

LMEMACQ

This is not for measuring the communications format.

This command presets the U2040 X-Series to values appropriate for long memory acquisition feature. Table below shows the value preset for long memory acquisition feature.

Parameter	Setting
Frequency	1 GHz
Sensor mode	Peak mode
Video BW	OFF
Average count auto	OFF
Step detect	OFF
Video average count	1
Average count	1
Gates: start, length	0, 100E-6 0,0 0,0 0,0
Trace length	1 s
Trace start	0
Trigger delay	0
Trigger slope	Positive
Trigger auto level	On

SYSTem:SET

Syntax

```
SYSTem:SET <arbitrary_block_data>
```

Description

This command is used to set the U2040 X-Series state as defined by the data returned by the *LRN? query.

Parameter

Item	Range of values	Description/Default value
arbitrary_block_data	#nN<instrument state> ^[a]	The block data returned by the *LRN query.

[a] The first digit after the # indicates the number of following digits. The following digits indicate the length of the data.

SYSTem:VERsion?

Syntax

```
SYSTem:VERsion?
```

Description

This query returns the version of SCPI used in the U2040 X-Series. The response is in the form of XXXX.Y, where XXXX is the year and Y is the version number.

Example

```
SYST:VERS?           Queries which version of SCPI is used in the U2040 X-Series.
```

Keysight U2040 X-Series Wide Dynamic Range Power Sensors Programming Guide

20 TRACe Subsystem

TRACe[1]:STATe	406
TRACe[1]:UNIT	407
TRACe[1][:DATA]?	408
TRACe[1]:DEFine:DURation:REFerence	411
TRACe[1]:DEFine:TRANsition:REFerence	412
TRACe[1]:MEASurement:REFerence?	413
TRACe[1]:MEASurement:INSTant:REFerence?	414
TRACe[1]:MEASurement:PULSe[1] 2 3 4 5 6 7 8 9 ..20:AM?	415
TRACe[1]:MEASurement:PULSe[1] 2 3 4 5 6 7 8 9 ..20:AT?	416
TRACe[1]:MEASurement:PULSe[1] 2 3 4 5 6 7 8 9 ..20:DCYCLE?	417
TRACe[1]:MEASurement:PULSe[1] 2 3 4 5 6 7 8 9 ..20:DURation?	418
TRACe[1]:MEASurement:PULSe[1] 2 3 4 5 6 7 8 9 ..20:PERiod?	419
TRACe[1]:MEASurement:PULSe[1] 2 3 4 5 6 7 8 9 ..20:SEParation?	420
TRACe[1]:MEASurement:PULSe[1] 2 3 4 5 6 7 8 9 ..20:TILT?	421
TRACe[1]:MEASurement:TRANsition[1] 2 3 4 5 6 7 8 9 ..20:NEGative:DURation?	422
TRACe[1]:MEASurement:TRANsition[1] 2 3 4 5 6 7 8 9 ..20:NEGative:OCCurrence?	423
TRACe[1]:MEASurement:TRANsition[1] 2 3 4 5 6 7 8 9 ..20:POSitive:DURation?	424
TRACe[1]:MEASurement:TRANsition[1] 2 3 4 5 6 7 8 9 ..20:POSitive:OCCurrence?	425
TRACe[1]:MEASurement:TILT:UNIT	426
TRACe[1]:OFFSet:TIME	427
TRACe[1]:TIME	428
TRACe[1]:AUToscale	429

This chapter describes the TRACe subsystem commands.

TRACe[1]:STATE^[1]

Syntax

```
TRACe[1]:STATE ON|OFF|1|0
```

```
TRACe[1]:STATE?
```

Description

This command enables or disables trace capture for the specified channel.

The query enters a 1 or 0 into the output buffer indicating whether or not trace capture is enabled or disabled.

- 1 is returned when trace capture is enabled
- 0 is returned when trace capture is disabled

NOTE

This command does not allow ON to be set when SENS:MRAT is set to FAST or TRIG:SOUR is not set to INT or EXT.

Example

```
TRAC:STAT 1      Enables trace capture.
```

Reset condition

On reset, trace capture is set to OFF.

Error messages

- If TRAC:STAT is set to ON while LIST:STAT is set to ON, error -221, "Settings conflict;list mode is enabled" occurs.
- If DET:FUNC is set to AVER, error -221, "Settings conflict" occurs.
- If TRIG:SOUR is not INT or EXT, error -221, "Settings conflict" occurs.

[1] Applicable for U2042XA/U2044XA/U2049XA only.

TRACe[1]:UNIT^[1]

Syntax

```
TRACe[1]:UNIT DBM|W
```

```
TRACe[1]:UNIT?
```

Description

This command sets the unit for the trace.

The query returns the current trace unit.

NOTE

This command is included for compatibility purposes only. It has the same purpose as [:SENSe[1]:]TRACe:UNIT, which is the preferred command.

Example

```
TRAC:UNIT W      Sets the trace unit to watts.
```

Reset condition

On reset, the unit is set to dBm.

[1] Applicable for U2042XA/U2044XA/U2049XA only.

TRACe[1][:DATA]?^[1]

Syntax

```
TRACe[1][:DATA]? <character_data>
```

Description

This query returns the trace data. The trace resolution is determined by <character_data>.

Data is returned in the IEEE-488.2 arbitrary block program data format as follows:

```
#xyy...ydd.....ddd<LF>
```

The diagram shows the format `#xyy...ydd.....ddd<LF>`. A vertical line on the left indicates the start of the block. The character `x` is labeled as 'The number of data bytes (d) contained in the block'. The characters `yy` are labeled as 'The number of y digits'. The characters `ydd` are labeled as 'Data bytes'. The characters `ddd` are labeled as 'Data bytes'. The `<LF>` is labeled as 'Line feed character signifies the end of the block'.

Example: if there are 12435 data bytes, $y = 12435$ and $x = 5$

Each point in the trace is represented as an IEEE-754 32-bit floating point number, made up of four bytes in the data block. The MS byte is transmitted first. Each complete block is terminated by a line feed.

NOTE

The TRACe data formatting is not affected by the FORMAt subsystem formatting.

[1] Applicable for U2042XA/U2044XA/U2049XA only.

Parameter

Item	Range of values	Description/Default value
character_data	HRES MRES LRES LMEM	<ul style="list-style-type: none"> - HRESolution: High resolution. The complete capture buffer at the internal sample rate. The number of points in this trace is not fixed, as it is affected by the SENSE:TRACe:TIME setting. - MRESolution: Medium resolution. A subset of the capture buffer – the buffer contents are decimated to 1000 data points. - LRESolution: Low resolution. A subset of the capture buffer – the buffer contents are decimated to provide 250 data points. This is the same number of data points as the U2040 X-Series uses to display the trace. Hence, the LRES command can be used to replicate the trace display. - LMEM: Long MEMory Acquisition. The complete capture buffer at the internal sample rate. Number of maximum points in this trace is 1 Mega Samples^[a]. Setting SENSE:TRACe:MEMemory:SIZE to LMEM is required as a prior condition to use this parameter.

[a] Applicable for U2049XA only

Example

TRAC? HRES	Returns the trace data at high resolution.
TRAC? LMEM	Returns the trace data using long acquisition memory method.

Error messages

- If TRAC:STAT is off, error -221, "Settings conflict" occurs.
- If the last measurement is invalid, error -230, "Data corrupt or stale" occurs. A measurement is valid after it has been initiated. The measurement is invalid when either a reset occurs or any measurement parameter such as frequency is changed.
- If SENSE:TRACe:MEMemory:SIZE is not set to LMEM, error -221, "Settings conflict" occurs while using TRACe? LMEM.

NOTE

When `TRIG:SOUR` is `INT1` or `EXT` and a new acquisition has been initiated (using the `INIT` command for example), `TRACe?` waits until the trigger takes place before executing. If trigger conditions are not satisfied - when the trigger level differs greatly from the signal level for example - this can give the impression that the U2040 X-Series has stopped responding.

To unlock the U2040 X-Series and adjust trigger settings, Device Clear should be executed (this is equivalent to “EXECUTE CLEAR” in Keysight VEE).

TRACe[1]:DEFine:DURation:REFerence^[1]

Syntax

```
TRACe[1]:DEFine:DURation:REFerence <numeric_value>
```

```
TRACe[1]:DEFine:DURation:REFerence?
```

Description

This command defines the reference levels to be used in the calculation of pulse durations. This allows pulse duration measurements between non-standard reference levels.

The query returns the numeric value of the reference level used in the pulse duration calculation.

Parameter

Item	Range of values	Description/Default value
numeric_value	0 to 100 DEF	Reference levels to be used in the calculation of pulse duration. DEF: the default value is 50%.

Example

```
TRAC:DEF:DUR:REF 25
```

Sets the trace pulse duration measurements to look for the 25% reference levels.

Reset condition

On reset, the reference level will become 50%, which is the default value (DEF).

[1] Applicable for U2042XA/U2044XA/U2049XA only.

TRACe[1]:DEFine:TRANsition:REFerence^[1]

Syntax

```
TRACe[1]:DEFine:TRANsition:REFerence
<numeric_value>,<numeric_value>
TRACe[1]:DEFine:TRANsition:REFerence?
```

Description

This command defines the reference levels to be used in the calculation of transition durations and occurrences. This allows transition measurements between non-standard reference levels.

The query returns the trace reference levels used in the transition occurrences calculation.

Parameter

Item	Range of values	Description/Default value
numeric_value	0 to 100 DEF	Reference levels to be used in the calculation of transition durations and occurrences. DEF: the default value is 10%, 90%.

Example

```
TRAC:DEF:TRAN:REF 1,81
```

Sets the trace transition measurements to look for the 1% and 81% reference levels.

Reset condition

On reset, the reference level will be set to 10% and 90% respectively.

[1] Applicable for U2042XA/U2044XA/U2049XA only.

TRACe[1]:MEASurement:REFerence?[1]

Syntax

```
TRACe[1]:MEASurement:REFerence? <numeric_value>
```

Description

This command is used to find the reference power level. This provides the reference power level to calculate the pulse parameters.

Commonly used reference levels are 0%, 10%, 50%, 90%, and 100%. You can set the reference level to measure overshoot at 125% and undershoot at -25%.

Algorithm

$$P_{x\%} = P_{0\%} + x/100 (P_{100\%} - P_{0\%})$$

where:

- $0\% \leq x \leq 100\%$
- $P_{0\%}$ = level of low state
- $P_{100\%}$ = level of high state
- $P_{0\%}$, $P_{100\%}$, and $P_{x\%}$ are all in the same unit of measurement, for example, watts.

Example

```
TRAC:MEAS:REF? 100           Returns the high state power for the trace.
```

Error message

If `TRIG:SOUR` is not set to `INT[1]` or `EXT`, or `SENS:DET:FUNC` is not set to `NORM`, error -221, "Settings conflict" occurs.

[1] Applicable for U2042XA/U2044XA/U2049XA only.

TRACe[1]:MEASurement:INSTant:REFerence?[1]

Syntax

```
TRACe[1]:MEASurement:INSTant:REFerence? <numeric_value>
```

Description

This query returns the time instant at which the power waveform intersects the reference level supplied as the command parameter. This allows the time instant used to calculate the pulse parameters to be found. It also allows the calculation of the transition between non-standard reference levels.

NOTE

This command is only applicable when the single or continuous triggered acquisition is selected.

Parameter

Item	Range of values	Description/Default value
numeric_value	-25 to 125%	Reference level in percentage

Example

```
TRAC:MEAS:INST:REF? 25
```

Returns the time instant for the trace when the power is transitioned through the 25% reference level.

[1] Applicable for U2042XA/U2044XA/U2049XA only.

TRACe[1]:MEASurement:PULSe[1]|2|3|4|5|6|7|8|9|..20:AM?^[1]

Syntax

```
TRACe[1]:MEASurement:PULSe[1]|2|3|4|5|6|7|8|9|..20:AM?
```

Description

This query returns the pulse amplitude power at the rising edge.

Example

```
TRAC:MEAS:PULS3:AM?
```

Returns the pulse amplitude, which is the rising edged power.

Error messages

- If the free-run acquisition mode is selected, error -221, "Settings conflict" occurs.
- If TRIG:SOUR is not INT or EXT, or SENS:DET:FUNC is not set to NORM, error -221, "Settings conflict" occurs.

NOTE

If you attempt to measure a pulse out of the range of the capture, for example, measure the fifth pulse and there are only four pulses, the U2040 X-Series returns 9.91E37 as the result.

[1] Applicable for U2042XA/U2044XA/U2049XA only.

TRACe[1]:MEASurement:PULSe[1]|2|3|4|5|6|7|8|9|..20:AT?[1]

Syntax

```
TRACe[1]:MEASurement:PULSe[1]|2|3|4|5|6|7|8|9|..20:AT?
```

Description

This query returns the trailing edge amplitude power at the falling edge.

Example

```
TRAC:MEAS:PULS3:AT?
```

Returns the trailing edge amplitude, which is the falling edge power.

Error messages

- If the free-run acquisition mode is selected, error -221, “Settings conflict” occurs.
- If TRIG:SOUR is not INT or EXT, or SENS:DET:FUNC is not set to NORM, error -221, “Settings conflict” occurs.

NOTE

If you attempt to measure a pulse out of the range of the capture, for example, measure the fifth pulse and there are only four pulses, the U2040 X-Series returns 9.91E37 as the result.

[1] Applicable for U2042XA/U2044XA/U2049XA only.

TRACe[1]:MEASurement:PULSe[1]|2|3|4|5|6|7|8|9|..20:DCYClE?[1]

Syntax

```
TRACe[1]:MEASurement:PULSe[1]|2|3|4|5|6|7|8|9|..20:DCYClE?
```

Description

This query returns the duty cycle of the selected pulse in percentage.

Algorithm

Duty Cycle = (pulse duration / pulse period) * 100

where,

pulse duration is the time difference between positive and negative transitions of one pulse, and pulse period is the time difference between two consecutive transition occurrences of the same polarity.

Example

```
TRAC:MEAS:PULS3:DCYC?
```

Returns the duty cycle of the third pulse found on the trace.

Error messages

- If the free-run acquisition mode is selected, error -221, "Settings conflict" occurs.
- If TRIG:SOUR is not INT or EXT, or SENS:DET:FUNC is not set to NORM, error -221, "Settings conflict" occurs.

NOTE

If you attempt to measure a pulse out of the range of the capture, for example, measure the fifth pulse and there are only four pulses, the U2040 X-Series returns 9.91E37 as the result.

[1] Applicable for U2042XA/U2044XA/U2049XA only.

TRACe[1]:MEASurement:PULSe[1]|2|3|4|5|6|7|8|9|..20:DURation?^[1]

Syntax

```
TRACe[1]:MEASurement:PULSe[1]|2|3|4|5|6|7|8|9|..20:DURation?
```

Description

This query returns the difference between a pulse and next transition occurrence instants. As power pulses are by definition positive pulses, the pulse duration is the time difference between positive and negative transitions of one pulse.

Algorithm

If the first transition in the trace is positive,
then

`PULSe:DURation` = the time that the first negative transition occurs – the time that the first positive transition occurs

else

`PULSe:DURation` = the time that the second negative transition occurs – the time that the first positive transition occurs.

Example

```
TRAC:MEAS:PULS3:DUR?
```

Returns the duration of the third pulse found on the trace.

Error messages

- If the free-run acquisition mode is selected, error –221, “Settings conflict” occurs.
- If `TRIG:SOUR` is not `INT` or `EXT`, or `SENS:DET:FUNC` is not set to `NORM`, error –221, “Settings conflict” occurs.

NOTE

If you attempt to measure a pulse out of the range of the capture, for example, measure the fifth pulse and there are only four pulses, the U2040 X-Series returns 9.91E37 as the result.

[1] Applicable for U2042XA/U2044XA/U2049XA only.

TRACe[1]:MEASurement:PULSe[1]|2|3|4|5|6|7|8|9|..20:PERiod?^[1]

Syntax

```
TRACe[1]:MEASurement:PULSe[1]|2|3|4|5|6|7|8|9|..20:PERiod?
```

Description

This query returns the pulse period. This is the time difference between two consecutive transition occurrences of the same polarity. The period is equal to the sum of the pulse separation and the pulse duration.

Algorithm

If the first transition in the trace is positive,
then

`PULSe:PERiod` = the time that the second positive transition occurs – the time that the first positive transition occurs

else

`PULSe:PERiod` = the time that the second negative transition occurs – the time that the first negative transition occurs.

Example

```
TRAC:MEAS:PULS:PER?
```

Returns the period of the pulse found on the trace.

Error messages

- If the free-run acquisition mode is selected, error –221, “Settings conflict” occurs.
- If `TRIG:SOUR` is not `INT` or `EXT`, or `SENS:DET:FUNC` is not set to `NORM`, error –221, “Settings conflict” occurs.

NOTE

If you attempt to measure a pulse out of the range of the capture, for example, measure the fifth pulse and there are only four pulses, the U2040 X-Series returns 9.91E37 as the result.

[1] Applicable for U2042XA/U2044XA/U2049XA only.

TRACe[1]:MEASurement:PULSe[1]|2|3|4|5|6|7|8|9|..20:SEParation?^[1]

Syntax

```
TRACe[1]:MEASurement:PULSe[1]|2|3|4|5|6|7|8|9|..20:SEParation?
```

Description

This query returns the time difference of the n^{th} and $(n+1)^{\text{th}}$ pulses found on a trace. As power pulses are by definition positive pulses, the pulse separation is the time difference between the negative transition of one pulse and the positive transition of the next pulse.

Algorithm

If the first transition in the trace is positive,

then

`PULSe:SEParation` = the time that the second positive transition occurs – the time that the first negative transition occurs.

else

`PULSe:SEParation` = the time that the first positive transition occurs – the time that the first negative transition occurs.

Example

<code>TRAC:MEAS:PULS:SEP?</code>	Returns the time separation of the 1st and 2nd pulses found on the trace.
----------------------------------	---

Error messages

- If the free-run acquisition mode is selected, error –221, “Settings conflict” occurs.
- If `TRIG:SOUR` is not `INT` or `EXT`, or `SENS:DET:FUNC` is not set to `NORM`, error –221, “Settings conflict” occurs.

NOTE

If you attempt to measure a pulse out of the range of the capture, for example, measure the fifth pulse and there are only four pulses, the U2040 X-Series returns 9.91E37 as the result.

[1] Applicable for U2042XA/U2044XA/U2049XA only.

TRACe[1]:MEASurement:PULSe[1]|2|3|4|5|6|7|8|9|..20:TILT?^[1]

Syntax

```
TRACe[1]:MEASurement:PULSe[1]|2|3|4|5|6|7|8|9|..20:TILT?
```

Description

This query returns the tilted droop, which is the difference between the pulse amplitude and the trailing edge amplitude.

Algorithm

The algorithm approximates the power of the rising edge and compares it with the approximated power of the falling edge to calculate the number of power changes along the pulse top.

$$\text{Tilt (\%)} = [(AM - AT)/AM] * 100\%$$

where,

- AM is the rising edge power
- AT is the falling edge power

Example

```
TRAC:MEAS:PULS3:TILT?
```

Returns the pulse tilt from the rising edge until the falling edge.

Error messages

- If the free-run acquisition mode is selected, error -221, "Settings conflict" occurs.
- If TRIG:SOUR is not INT or EXT, or SENS:DET:FUNC is not set to NORM, error -221, "Settings conflict" occurs.

NOTE

If you attempt to measure a pulse out of the range of the capture, for example, measure the fifth pulse and there are only four pulses, the U2040 X-Series returns 9.91E37 as the result.

[1] Applicable for U2042XA/U2044XA/U2049XA only.

TRACe[1]:MEASurement:TRANSition[1]|2|3|4|5|6|7|8|9|..20:NEGative:DURation?[1]

Syntax

```
TRACe[1]:MEASurement:TRANSition[1]|2|3|4|5|6|7|8|9|..20:NEGative:
DURation?
```

Description

This query returns the nth negative transition duration found on a trace.

Reset condition

On reset, this parameter is not affected.

Example

```
TRAC:MEAS:TRAN8:NEG:DUR? Returns the eighth negative transition duration
found on the trace.
```

Error messages

- If the free-run acquisition mode is selected, error -221, "Settings conflict" occurs.
- If TRIG:SOUR is not INT or EXT, or SENS:DET:FUNC is not set to NORM, error -221, "Settings conflict" occurs.

NOTE

If you attempt to measure a pulse out of the range of the capture, for example, measure the fifth pulse and there are only four pulses, the U2040 X-Series returns +0.00000000E+000 as the result.

[1] Applicable for U2042XA/U2044XA/U2049XA only.

TRACe[1]:MEASurement:TRANsition[1]|2|3|4|5|6|7|8|9|..20:NEGative:OCCurence?[1]

Syntax

```
TRACe[1]:MEASurement:TRANsition[1]|2|3|4|5|6|7|8|9|..20:NEGative:OCCurence?
```

Description

This query returns the position, relative to the trigger instant, of the n^{th} occurrence of a negative transition found on a trace.

Reset condition

On reset, this parameter is not affected.

Example

```
TRAC:MEAS:TRAN7:NEG:OCC?
```

Returns the position, relative to the trigger instant, of the seventh occurrence of a negative transition found on the trace.

Error messages

- If the free-run acquisition mode is selected, error -221, "Settings conflict" occurs.
- If TRIG:SOUR is not INT or EXT, or SENS:DET:FUNC is not set to NORM, error -221, "Settings conflict" occurs.

NOTE

If you attempt to measure a pulse out of the range of the capture, for example, measure the fifth pulse and there are only four pulses, the U2040 X-Series returns +0.00000000E+000 as the result.

[1] Applicable for U2042XA/U2044XA/U2049XA only.

TRACe[1]:MEASurement:TRANSition[1]|2|3|4|5|6|7|8|9|..20:POSitive:DURation?[1]

Syntax

```
TRACe[1]:MEASurement:TRANSition[1]|2|3|4|5|6|7|8|9|..20:POSitive:
DURation?
```

Description

This query returns the n^{th} positive transition duration found on a trace.

Reset condition

On reset, this parameter is not affected.

Example

<code>TRAC:MEAS:TRAN10:POS:DUR?</code>	Returns the tenth positive transition duration found on the trace.
--	--

Error messages

- If the free-run acquisition mode is selected, error -221, "Settings conflict" occurs.
- If `TRIG:SOUR` is not `INT` or `EXT`, or `SENS:DET:FUNC` is not set to `NORM`, error -221, "Settings conflict" occurs.

NOTE

If you attempt to measure a pulse out of the range of the capture, for example, measure the fifth pulse and there are only four pulses, the U2040 X-Series returns `+0.00000000E+000` as the result.

[1] Applicable for U2042XA/U2044XA/U2049XA only.

TRACe[1]:MEASurement:TRANsition[1]|2|3|4|5|6|7|8|9|..20:POSitive:OCCurrence?[1]

Syntax

```
TRACe[1]:MEASurement:TRANsition[1]|2|3|4|5|6|7|8|9|..20:POSitive:OCCurrence?
```

Description

This query returns the position, relative to the trigger instant, of the n^{th} occurrence of a positive transition found on a trace.

Reset condition

On reset, this parameter is not affected.

Example

```
TRAC:MEAS:TRAN:POS:OCC?
```

Returns the position, relative to the trigger instant, of the first occurrence of a positive transition found on the trace.

Error messages

- If the free-run acquisition mode is selected, error -221, "Settings conflict" occurs.
- If TRIG:SOUR is not INT or EXT, or SENS:DET:FUNC is not set to NORM, error -221, "Settings conflict" occurs.

NOTE

If you attempt to measure a pulse out of the range of the capture, for example, measure the fifth pulse and there are only four pulses, the U2040 X-Series returns +0.00000000E+000 as the result.

[1] Applicable for U2042XA/U2044XA/U2049XA only.

TRACe[1]:MEASurement:TILT:UNIT^[1]

Syntax

```
TRACe[1]:MEASurement:TILT:UNIT PCT|DB
```

```
TRACe[1]:MEASurement:TILT:UNIT?
```

Description

This command sets the unit for the tilt (droop) measurement.

The query returns the unit of the tilt (droop) measurement.

Example

```
TRAC:MEAS:TILT:UNIT PCT      Sets the unit to % for the tilt (droop) measurement.
```

Reset condition

On reset, the unit is set to dB.

[1] Applicable for U2042XA/U2044XA/U2049XA only.

TRACe[1]:OFFSet:TIME^[1]

Syntax

```
TRACe[1]:OFFSet:TIME <numeric_value>
```

```
TRACe[1]:OFFSet:TIME?
```

Description

This command sets the delay between the delayed trigger point and the start of the trace for the U2040 X-Series.

The query returns the current delay between the delayed trigger point and the start of the trace.

Parameter

Item	Range of values	Description/Default value
numeric_value	-1 to 1 s DEF	The length of the delay in seconds. - DEF: the default value is 0 s Units are resolved to 50 ns.

Example

```
TRAC:OFFS:TIME 0.05
```

Sets the delay to 0.05 s.

Reset condition

On reset, the delay is set to 0 s.

Error message

If DEF:FUNC is set to AVER, error -221, "Settings conflict" occurs.

[1] Applicable for U2042XA/U2044XA/U2049XA only.

TRACe[1]:TIME^[1]

Syntax

```
TRACe[1]:TIME <numeric_value>
```

```
TRACe[1]:TIME?
```

Description

This command sets the duration of the trace for the U2040 X-Series.

The query returns the current duration of the trace.

Parameter

Item	Range of values	Description/Default value
numeric_value	100 ns to 1 s DEF	The length of the trace in seconds. - DEF: the default value is 100 μ s Units are resolved to 50 ns.

Example

```
TRAC:TIME 0.5
```

Sets the duration of the trace to 0.5 s.

Reset condition

On reset, the duration is set to 100 μ s.

Error message

If DET:FUNC is set to AVER, error -221, "Settings conflict" occurs.

[1] Applicable for U2042XA/U2044XA/U2049XA only.

TRACe[1]:AUToscale^[1]

Syntax

```
TRACe[1]:AUToscale
```

Description

This command automatically scales the trace capture to between 20% to 50% of the x-scale (time axis) with the triggering edge aligned to the center of the trace. This means that the trigger level, trigger delay, holdoff, and gate 1 to 4 duration and offset will be overwritten. Additionally, upon successful autoscaling, the trigger source will be set to INT, and INIT:CONT will remain unchanged. Perpetual gating will also be disabled.

Example

```
TRAC:AUT           Automatically scales the trace capture.
```

Error messages

- If TRAC:AUT is set while DET:FUNC is set to AVER, error -221, "Settings conflict" occurs.
- If TRAC:AUT is set while TRAC:STAT is set to OFF, error -221, "Settings conflict" occurs.
- If TRAC:AUT is set while TRIG:SOUR is set to EXT, error -221, "Settings conflict" occurs.

[1] Applicable for U2042XA/U2044XA/U2049XA only.

THIS PAGE HAS BEEN INTENTIONALLY LEFT BLANK.

Keysight U2040 X-Series
Wide Dynamic Range Power Sensors
Programming Guide

21 TRIGger Subsystem

TRIGger[1][:SEQuence[1]]:COUNt	432
TRIGger[1][:SEQuence[1]]:DELay	434
TRIGger[1][:SEQuence[1]]:DELay:AUTO	436
TRIGger[1][:SEQuence[1]]:HOLDoff	437
TRIGger[1][:SEQuence[1]]:HYSTeresis	438
TRIGger[1][:SEQuence[1]][:IMMEDIATE]	439
TRIGger[1][:SEQuence[1]]:LEVel	440
TRIGger[1][:SEQuence[1]]:LEVel:AUTO	441
TRIGger[1][:SEQuence[1]]:QUALifier:TIME	442
TRIGger[1][:SEQuence[1]]:SLOPe	443
TRIGger[1][:SEQuence[1]]:SOURce	444

This chapter describes the TRIGger subsystem commands.

TRIGger[1][:SEQuence[1]]:COUNT

Syntax

```
TRIGger[1][:SEQuence[1]]:COUNT <numeric_value>
TRIGger[1][:SEQuence[1]]:COUNT? [MIN|MAX]
```

Description

This command controls the path of the trigger subsystem in the upward traverse of the wait-for-trigger state. `COUNT` loops through the event detection/measurement cycle performed. That is, `COUNT` measurements are performed in response to `COUNT` trigger events.

`COUNT` can be set to a value >1 only when `[:SENSe[1]:]MRATe` is set to `FAST`.

When `COUNT` is set to a value >1,

- `CALibration[1]:ZERO:AUTO` will switch to `OFF` automatically. It will be restored to its default setting when `COUNT` is set to 1.
- Setting a channel from the `FAST` mode to the `NORMal` mode or `DOUBle` mode will also restore both the `CALibration[1]:ZERO:AUTO` and `COUNT` to their default settings automatically.

The query returns the current setting of trigger events or the values associated with `MIN` and `MAX`.

Parameter

Item	Range of values	Description/Default value
numeric_value	1 to 200	The number of triggered events for the measurement cycle.
	DEF	- DEF: the default value is 1
	MIN	- MIN: 1
	MAX	- MAX: 200

Example

```
TRIG:COUN 10
```

Sets the number of triggered events to 10 for the measurement cycle.

Reset condition

On reset, the value is set to 1.

Error message

If `COUNT > 1` when `[:SENSE[1] :]MRATE` is set to `NORMAL` or `DOUBLE`, error -221, "Settings conflict" occurs.

TRIGger[1][:SEquence[1]]:DELay

Command

```
TRIGger[1][:SEquence[1]]:DELay <numeric_value>
```

Description

This command sets the delay between the recognition of a trigger event and the start of a measurement.

Parameters

Item	Range of values	Description/Default value
numeric_value	-1 to 1 s DEF	The delay between the recognition of a trigger event and the start of the measurement, in seconds. - DEF: the default value is 0 s - MIN: -1 s - MAX: 1 s Units are resolved to 50 ns.

NOTE

When SENS:TRAC:MEM:SIZE is LMEM, the range is from -10E-3 to 1 s. For more details, refer to “[:SENSe[1]:]TRACe:MEMemory:SIZE” on page [272](#).

Example

```
TRIG:DEL 0.001      Sets a delay of 1 ms.
```

Reset condition

On reset, the trigger delay is set to 0 s.

Query

```
TRIGger[1][:SEquence[1]]:DELay? [MIN|MAX]
```

The query returns the current setting of the trigger delay or the value associated with MIN and MAX.

Error message

If the trigger source is not set to `INT` or `EXT` while setting `TRIGger[:SEQuence]:DELay`, error -221, “Settings conflict” occurs.

TRIGger[1][:SEQuence[1]]:DELay:AUTO

Command

```
TRIGger[1][:SEQuence[1]]:DELay:AUTO ON|OFF|1|0
```

Description

This command is used to determine whether or not there is a settling-time delay before a measurement is made.

When this command is set to:

- **ON**, the U2040 X-Series inserts a settling-time delay before taking the requested measurement and for subsequent measurements. This settling time allows the internal digital filter to be updated with new values to produce valid, accurate measurement results. The trigger with delay command allows settling time for the internal amplifiers and filters. It does not allow time for delay.

In cases of large power changes, the delay may not be sufficient for complete settling. Accurate readings can be assured by taking two successive measurements for comparison.

- **OFF**, no settling-time delay is inserted and the U2040 X-Series makes the measurement immediately when a trigger is received.

TRIGger:DELay:AUTO is ignored if TRIGger[1][:IMMediate] is set to ON.

Example

```
TRIG:DEL:AUTO ON           Enables a delay.
```

Reset condition

On reset, TRIGger:DELay:AUTO is set to ON.

Query

```
TRIGger[1][:SEQuence[1]]:DELay:AUTO?
```

The query enters a 1 or 0 into the output buffer indicating the status of TRIGger:DELay:AUTO.

- 1 is returned when it is ON
- 0 is returned when it is OFF

TRIGger[1][:SEQuence[1]]:HOLDoff

Command

```
TRIGger[1][:SEQuence[1]]:HOLDoff <numeric_value>
```

Description

This command sets the trigger holdoff in seconds.

Parameter

Item	Range of values	Description/Default value
numeric_value	1 μ s to 0.4 s DEF MIN MAX	The trigger holdoff in seconds. - DEF: the default value is 1 μ s - MIN: 1 μ s - MAX: 0.4 s Units are resolved to 50 ns.

Example

```
TRIG:HOLD 0.1 Sets the trigger holdoff to 100 ms.
```

Reset condition

On reset, the trigger holdoff is set to 1 μ s.

Query

```
TRIGger[1][:SEQuence[1]]:HOLDoff? [MIN|MAX]
```

The query returns the current trigger holdoff setting or the value associated with MIN and MAX.

Error message

If the trigger source is not set to INT or EXT while setting TRIGger[:SEQuence]:HOLDoff, error -221, "Settings conflict" occurs.

TRIGger[1][:SEQuence[1]]:HYSTeresis^[1]

Command

```
TRIGger[1][:SEQuence[1]]:HYSTeresis <numeric_value>
```

Description

This command sets:

- How far a signal must fall below TRIG:LEVe1 before a rising edge can be detected.
- How far a signal must rise above TRIG:LEVe1 before a falling edge can be detected.

Parameter

Item	Range of values	Description/Default value
numeric_value	0 to 3 dB DEF MIN MAX	How far a signal must fall/rise before a rising or falling edge can be detected. - DEF: the default value is 0 dB - MIN: 0 dB - MAX: 3 dB Units are resolved to 0.05 dB.

Example

```
TRIG:HYST 0.1 Sets the value to 0.1 dB.
```

Reset condition

On reset, the value is set to 0 dB.

Query

```
TRIGger[1][:SEQuence[1]]:HYSTeresis? [MIN|MAX]
```

The query returns the current value in dB or the values associated with MIN and MAX.

Error message

If the trigger source is not set to INT or EXT while setting

```
TRIGger[:SEQuence]:HYSTeresis, error -221, "Settings conflict" occurs.
```

[1] Applicable for U2042XA/U2044XA/U2049XA only.

TRIGger[1][:SEQuence[1]][:IMMediate]

Command

```
TRIGger[1][:SEQuence[1]][:IMMediate]
```

Description

This command provides a one time override of the normal process of the downward path through the wait-for-trigger state. It causes the immediate exit of the event detection layer if the trigger system is in this layer when the command is received. In other words, the U2040 X-Series stops waiting for a trigger and takes a measurement ignoring any delay set by TRIG:DELaY.

Example

```
TRIG:IMM          Initiates a measurement.
```

TRIGger[1][:SEquence[1]]:LEVel^[1]

Command

```
TRIGger[1][:SEquence[1]]:LEVel <numeric_value>
```

Description

This command sets the power level at which a trigger event is recognized.

Parameter

Item	Range of values ^[a]	Description/Default value
numeric_value	-40 to 20 dBm	The power level at which a trigger event is recognized.
	DEF	- DEF: the default value is 0 dBm
	MIN	- MIN: -40 dBm
	MAX	- MAX: 20 dBm

[a] If a channel offset has been previously set, a higher numeric value is permitted. See “**Setting Offsets**” on page 47 for more information.

Example

```
TRIG:LEV 10
```

Sets the power level for a trigger event to 10 dBm.

Reset condition

On reset, the power level is set to 0 dBm.

Query

```
TRIGger[1][:SEquence[1]]:LEVel? [MIN|MAX]
```

The query returns the current power level setting or the values associated with MIN and MAX.

Error message

If the trigger source is not set to INT while setting TRIGger[:SEquence]:LEVel, error -221, “Settings conflict” occurs.

[1] Applicable for U2042XA/U2044XA/U2049XA only.

TRIGger[1][:SEQuence[1]]:LEVel:AUTO^[1]

Command

```
TRIGger[1][:SEQuence[1]]:LEVel:AUTO ON|OFF|1|0|ONCE
```

Description

This command enables/disables automatic setting of the trigger level.

When this command is set to:

- ON, automatic setting of the trigger level is enabled.
- OFF, automatic setting of the trigger level is disabled.
- ONCE, automatic setting of the trigger level is enabled for one trigger event only. The value is then set to OFF.

Example

```
TRIG:LEV:AUTO 0
```

 Disables the automatic setting of the trigger level.

Reset condition

On reset, the value is set to ON.

Query

```
TRIGger[1][:SEQuence[1]]:LEVel:AUTO?
```

The query enters a 1 or 0 into the output buffer indicating the status of

```
TRIGger[1][:SEQuence[1]]:LEVel:AUTO.
```

- 1 is returned when it is ON
- 0 is returned when it is OFF

[1] Applicable for U2042XA/U2044XA/U2049XA only.

TRIGger[1][:SEQuence[1]]:QUALifier:TIME

Command

```
TRIGger[1][:SEQuence[1]]:QUALifier:TIME <numeric_value>
```

Description

This command sets the trigger qualification time for stable triggering when measuring modulated signals.

Parameter

Item	Range of values	Description/Default value
numeric_value	100E-9 to 50E-6 DEF MIN MAX	The trigger qualification time in seconds. - DEF: the default value is 100E-9 - MIN: 100E-9 - MAX: 50E-6 Units are resolved to 50 ns.

Example

```
TRIG:QUAL:TIME 1E-6
```

Sets the trigger qualification time to 1 μ s.

Reset condition

On reset, the value is set to 100E-9 s.

Query

```
TRIGger[1][:SEQuence[1]]:QUALifier:TIME? [MIN|MAX]
```

The query returns the current trigger qualification time setting or the values associated with MIN and MAX.

Error messages

- If this command is sent when TRIG:SOUR is not set to EXTERNAL or INTERNAL[1], error -221, "Settings conflict" occurs.
- If the limits of the values are exceeded, error -222, "Data out of range" occurs.

TRIGger[1][:SEQuence[1]]:SLOPe

Command

```
TRIGger[1][:SEQuence[1]]:SLOPe <character_data>
```

Description

This command specifies whether a trigger event is recognized on the rising or falling edge of a signal.

Parameter

Item	Range of values	Description/Default value
character_data	POSitive NEGative	<p>How a trigger event is recognized:</p> <ul style="list-style-type: none"> - POSitive: a trigger event is recognized on the rising edge of a signal. - NEGative: a trigger event is recognized on the falling edge of a signal.

Example

```
TRIG:SLOP NEG
```

Sets the trigger event to be recognized on the falling edge of the triggering signal.

Reset condition

On reset, the value is set to POSitive.

Query

```
TRIGger[1][:SEQuence[1]]:SLOPe?
```

The query returns the current value of <character_data>.

Error message

If the trigger source is not set to INT or EXT while setting TRIGger[:SEQuence]:SLOPe, error -221, "Settings conflict" occurs.

TRIGger[1][:SEQuence[1]]:SOURce

Command

```
TRIGger[1][:SEQuence[1]]:SOURce
BUS|EXTErnal|HOLD|IMMediate|INTErnal|INTErnal1
```

Description

This command configures the trigger system to respond to the specified source. This command only selects the trigger source. Use the `INITiate` command to place the U2040 X-Series in the wait-for-trigger state.

Parameter

Item	Range of values	Description/Default value
		Available trigger sources:
		- BUS : the trigger source is the group execute trigger <GET> bus command, a *TRG common command, or the <code>TRIGger:IMMediate</code> SCPI command.
		- EXTErnal : the trigger source is the external trigger input.
		- HOLD : triggering is suspended. The only way to trigger the U2040 X-Series is to use <code>TRIGger:IMMediate</code> .
source	BUS EXTErnal HOLD IMMediate INTErnal INTErnal1	- IMMediate : the trigger system is always true. If <code>INITiate:CONTinuous</code> is ON, the U2040 X-Series is continually triggering free (free run mode). If an <code>INITiate:IMMediate</code> command is sent, a measurement is triggered then the U2040 X-Series returns to the idle state. This is the default trigger source.
		- INTErnal^[a] : the trigger source is the internal trigger input.
		- INTErnal1^[a] : the trigger source is Channel A.

[a] Applicable for U2042XA/U2044XA/U2049XA only.

NOTE

- The trigger source is set to `IMMediate` upon instrument power-up.
- If the trigger source is set to `BUS` or `HOLD`, the `MEASure` and `CONFIgure` commands automatically set the trigger source to `IMMediate`.
- The `READ?` or `MEASure` commands should not be used if the trigger source is set to `BUS` or `HOLD`.

Example

`TRIG:SOUR IMM` Configures the U2040 X-Series for immediate triggering.

Reset condition

On reset, the trigger source is set to `IMMEDIATE`.

Query

`TRIGger [1] [:SEQuence [1]] :SOURce?`

The query returns the current trigger source.

Error messages

- If `TRIG:SOUR` is not set to `EXT` while `LIST:STAT` is set to `ON`, error -221, “Settings conflict;list mode is enabled” occurs.
- If the source is changed to `INT` and `DET:FUNC` is set to `AVER`, error -221, “Settings conflict” occurs^[1].

[1] Applicable for U2042XA/U2044XA/U2049XA only.

THIS PAGE HAS BEEN INTENTIONALLY LEFT BLANK.

Keysight U2040 X-Series
Wide Dynamic Range Power Sensors
Programming Guide

22 UNIT Subsystem

UNIT[1]|2|3|4:POWer [448](#)

UNIT[1]|2|3|4:POWer:RATio [449](#)

This chapter describes the `UNIT` subsystem commands.

UNIT[1]|2|3|4:POWer

Command

```
UNIT[1]|2|3|4:POWer W|DBM
```

Description

This command sets the power measurement unit for a specified CALCulate block.

- UNIT1:POWer sets the power measurement unit for CALCulate1.
- UNIT2:POWer sets the power measurement unit for CALCulate2.
- UNIT3:POWer sets the power measurement unit for CALCulate3.
- UNIT4:POWer sets the power measurement unit for CALCulate4.

For ratio and relative power measurements:

- If UNIT:POWer is W, the measurement unit is %.
- If UNIT:POWer is DBM, the measurement unit is dB relative.

Example

```
UNIT:POW DBM           Sets the power measurement unit of dBm for CALCulate1.
```

Reset condition

On reset, all CALCulate blocks are set to DBM.

Query

```
UNIT[1]|2|3|4:POWer?
```

The query returns the current setting of the power measurement unit.

UNIT[1]|2|3|4:POWer:RATio

Command

```
UNIT[1] | 2 | 3 | 4 : POWer : RATio DB | PCT
```

Description

This command sets the ratio unit for a specified CALCulate block.

- UNIT1:POWer:RATio sets the ratio measurement unit for CALCulate1.
- UNIT2:POWer:RATio sets the ratio measurement unit for CALCulate2.
- UNIT3:POWer:RATio sets the ratio measurement unit for CALCulate3.
- UNIT4:POWer:RATio sets the ratio measurement unit for CALCulate4.

Example

```
UNIT:POW:RAT DB      Sets the ratio measurement unit of dB for CALCulate1.
```

Reset condition

On reset, the value is set to dB.

Query

```
UNIT[1] | 2 | 3 | 4 : POWer : RATio?
```

The query returns the current setting of the ratio measurement unit.

THIS PAGE HAS BEEN INTENTIONALLY LEFT BLANK.

Keysight U2040 X-Series
Wide Dynamic Range Power Sensors
Programming Guide

23 Programming Examples

Example 1: Two Time Slot GSM Measurement [452](#)

Example 2: Achieve Measurement Speed of >20000 Readings/s [453](#)

Example 3: Achieve Fast Measurement Speed of 50000 Readings/s [455](#)

Example 4: Capture Every Timeslot in GSM Frames [456](#)

This chapter provides programming sequence examples to remotely control the U2040 X-Series using SCPI commands.

Example 1: Two Time Slot GSM Measurement

The following command sequence provides the example to perform the two time slot GSM measurement.

NOTE

“=>” indicates the commands that you send to the U2040 X-Series.

Configuration stage

```
=> TRIG:SOUR EXT // Sets the trigger source to external trigger input.
=> OUTP:TRIG ON // Enables the trigger output signal.
=> SENS:LIST:STAT ON // Enables the list mode.
```

List mode setup stage

```
=> SENS:LIST:POIN 100 // Sets the measurement points to 100.
=> SENS:LIST:MTYP AVER // Sets the measurement type to average power.
=> SENS:LIST:TSC 2 // Sets the number of slots to 2.
=> SENS:FREQ:STAR 1GHz // Sets the start frequency to 1 GHz.
=> SENS:FREQ:STOP 1GHz // Sets the stop frequency to 1 GHz.
=> SENS:LIST:TSL:TIME 577e-6 // Sets the measurement time slot to 577 μs.
=> SENS:LIST:TSL:TREF1 10 // Sets the measurement gate start time slot to 10%.
=> SENS:LIST:TSL:EXCL:TIME 0 // Sets the exclusion duration interval to 0 s.
=> SENS:LIST:TSL:EXCL:OFFS:TIME 0 // Sets the exclusion area offset time to 0 s.
```

Starting/re-starting the sequence and getting the results stage

```
=> INIT:CONT ON // Initiates the trigger sequence.
=> *OPC // Places an ASCII 1 in the output queue when all pending device operations
// have completed.
=> *ESR? // Returns the contents of the Standard Event Status Register and then
// clears it. Repeat this command until the sequence is completed (bit
// number is set to 1).
=> FETC? // Fetches the results.
```

Example 2: Achieve Measurement Speed of >20000 Readings/s

Free run mode

The following command sequence provides the example to achieve the measurement speed of >20000 readings/s in the free run mode.

NOTE

“=>” indicates the commands that you send to the U2040 X-Series.

```
=> SYST:PRES // Presets the U2040 X-Series to default values.
=> SENS:FREQ 1GHZ // Sets the frequency to 1 GHz.
=> INIT:CONT ON // Initiates the trigger sequence.
=> UNIT:POW W // Sets the power measurement unit for CALC1 to W.
=> FORM REAL // Sets the data format to REAL.
=> CAL:ZERO:AUTO OFF // Disables auto-zeroing.
=> CAL:AUTO OFF // Disables auto-calibration.
=> SENS:AVER:SDET OFF // Disables step detection.
=> SENS:DET:FUNC NORM // Changes measurement mode to NORM (Normal mode)
NOTE: This works for models with NORM function only.
=> SENS:MRAT FAST // Sets the measurement speed to fast mode.
=> TRIG:COUN 100 // Sets the buffer size of the U2040 X-Series to 100 to store 100
measurement readings.
=> FETC? // Fetches the reading.
```

External trigger gated mode

The following command sequences provide the example to achieve the measurement speed of >20000 readings/s in the external trigger gated mode.

NOTE

“=>” indicates the commands that you send to the U2040 X-Series.

```

=> SYST:PRES // Presets the U2040 X-Series to default values.
=> SENS:FREQ 1GHz // Sets the frequency to 1 GHz.
=> TRIG:SOUR EXT // Sets the trigger source to external trigger input.
=> SENS:MRAT FAST // Sets the measurement speed to fast mode.
=> SENS:DET:FUNC NORM // Changes measurement mode to NORM (Normal mode)
// NOTE: This works for models with NORM function only.
=> TRIG:COUN 100 // Sets the buffer size of the U2040 X-Series to 100 to store 100
// measurement readings.
=> CAL:ZERO:AUTO OFF // Disables auto-zeroing.
=> CAL:AUTO OFF // Disables auto-calibration.
=> SENS:SWE:OFFS:TIME <X> // Sets the delay to X value. The X value depends on the signal pulse width.
=> SENS:SWE:TIME <Y> // Sets the duration of the time-gated period to Y value. The Y value
// depends on the signal pulse width.
=> UNIT:POW W // Sets the power measurement unit for CALC1 to W.
=> FORM REAL // Sets the data format to REAL.
=> FETC? // Fetches the reading.

```

Example 3: Achieve Fast Measurement Speed of 50000 Readings/s

The following command sequence provides the example to achieve the fast measurement speed of 50000 readings/s.

NOTE

“=>” indicates the commands that you send to the U2040 X-Series.

```

=> SYST:PRES // Presets the U2040 X-Series to default values.
=> SENS:FREQ 1GHZ // Sets the frequency to 1 GHz.
=> UNIT:POW W // Sets the power measurement unit for CALC1 to W.
=> FORM REAL // Sets the data format to REAL.
=> CAL:ZERO:AUTO OFF // Disables auto-zeroing.
=> CAL:AUTO OFF // Disables auto-calibration.
=> SENS:AVER:SDET OFF // Disables step detection.
=> SENS:DET:FUNC AVER // Sets the measurement mode to average.
=> SENS:MRAT FAST // Sets the measurement speed to fast mode.
=> TRIG:COUN 200 // Sets the buffer size of the U2040 X-Series to 200 to store 200
// measurement readings.
=> SENS:SWE:APER 20e-6 // Sets the aperture size to 20 μs (and measurement throughput to 50000
// measurements per second).
=> FETC? // Fetches the reading.

```

Example 4: Capture Every Timeslot in GSM Frames

The following command sequence provides the example to capture every timeslot in GSM frames. Each timeslot is measured over a 475 μs duration, ignoring 50 μs of positive and negative transitions at the beginning/end of each timeslot.

The signal source is configured to generate a trigger at the beginning of each timeslot.

NOTE

“=>” indicates the commands that you send to the U2040 X-Series.

```

=> SYST:PRES // Presets the U2040 X-Series to default values.
=> SENS:FREQ 900MHz // Sets the frequency to 900 MHz.
=> CAL:ZERO:AUTO OFF // Disables auto-zeroing.
=> CAL:AUTO OFF // Disables auto-calibration.
=> SENS:AVER:SDET OFF // Disables step detection.
=> SENS:MRAT FAST // Sets the measurement speed to fast mode.
=> TRIG:COUN 128 // Sets the buffer size of the U2040 X-Series to 128 to store 128
// measurement readings.
=> TRIG:SOUR EXT // Sets the trigger source to external trigger input.
=> TRIG:DEL 50e-6 // Sets the trigger delay to 50  $\mu\text{s}$  (the start of aperture is delayed by 50  $\mu\text{s}$ 
// relative to the trigger instance).
=> SENS:SWE:APER 475e-6 // Sets the aperture size to 475  $\mu\text{s}$ .
=> FETC? // Fetches 128 continuous timeslots (16 GSM frames) at a time.

```



This information is subject to change without notice. Always refer to the Keysight website for the latest revision.

© Keysight Technologies 2015-2022
Edition 7, November 24, 2022

Printed in Malaysia



U2041-90003

www.keysight.com